

# Panasonic

ideas for life

**0.5 mm pitch  
floating structure type  
with high resistance  
to twisting**

**NARROW PITCH (0.5mm) CONNECTORS  
P5 SERIES - FLOATING TYPE -**



Socket

Header

**Compliance with RoHS Directive**

## FEATURES

1. The 0.5mm pitch stacking connector with a built-in floating mechanism.
2. Further reduction of equipment size is now possible.

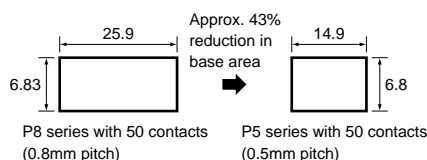

3. The original structure ensures higher reliability performance for both electrical and mechanical connections.

- Flux-creeping prevention structure (header)
  - Simple lock mechanism
4. **Automatic Mounting**
  5. **Porosity treatment applied for improved resistance against corrosion**

## APPLICATIONS

Small mobile equipment, such as mobile phones, PHSs, and PDAs

### What is a floating structure?

The header is a two-piece structure that can absorb any variation caused when a connector (header and socket) is integrated into a printed circuit board. (When two sets of connectors are used as shown below, a maximum deviation of 0.3mm can be absorbed.)

#### • Floating structure

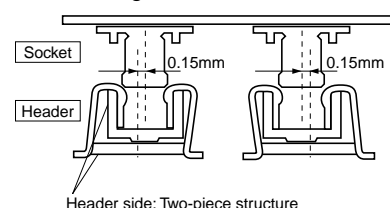

## ORDERING INFORMATION

AXN					5	G
5: Narrow Pitch Connector P5 Floating type (0.5 mm pitch) Socket						
6: Narrow Pitch Connector P5 Floating type (0.5 mm pitch) Header						
Number of contacts (2 digits)						
Mated direction / Mated height						
<Socket>						
0: For SMD vertical mating, mated height 5.0 mm						
<Header>						
5: For SMD vertical mating, mated height 5.0 mm						
Functions						
<Socket>						
4: Without soldering terminal, without positioning bosses						
<Header>						
8: With floating function, without soldering terminal, without positioning bosses						
Surface treatment (Contact portion / Terminal portion)						
5: Ni plating on base, Au plating on surface / Ni plating on base, Au plating on surface						
Packing						
G: 1,000 pieces embossed tape and plastic reel × 2						

# AXN(5/6)

## PRODUCT TYPES

Mated height	No. of contacts	Part No.		Packing quantity	
		Socket	Header	Inner carton (1 reel)	Outer carton
5.0 mm	20	AXN520045G	AXN620585G	1,000 pcs.	2,000 pcs.
	30	AXN530045G	AXN630585G		
	40	AXN540045G	AXN640585G		
	50	AXN550045G	AXN650585G		
	60	AXN560045G	AXN660585G		
	80	AXN580045G	AXN680585G		
	100	AXN500045G	AXN600585G		

Note) Connectors are available in a standard embossed tape package (1,000 pcs/lot). Minimum ordering quantity is a single reel.

Samples for mounting confirmation: Available in units of 50 pieces. Please consult us. (See "Regarding sample orders to confirm proper mounting" on page 150.)

Samples: Small lot orders for the above models are possible.

## SPECIFICATIONS

### 1. Characteristics

Item	Specifications	Conditions	
Electrical characteristics	Rated current	0.2A	
	Rated voltage	60V AC/DC	
	Breakdown voltage	150V AC for 1 min.	Detection current: 1mA
	Insulation resistance	Min. 100MΩ	Using 500V DC megger
	Contact resistance	Max. 80mΩ	Based on the contact resistance measurement method specified by JIS C 5402.
Mechanical characteristics	Composite insertion force	Max. 0.981N {100gf} × no. of contacts (initial)	
	Composite removal force	Min. 0.0785N {8gf} × no. of contacts	
	Contact holding force	Min. 2.94N {300gf}/2 contacts	Measuring the maximum force. As the contact is axially pull out.
Environmental characteristics	Ambient temperature	-55°C to +85°C	No freezing at low temperatures
	Soldering heat resistance	Max. peak temperature of 245°C (on the surface of the PC board around the connector terminals)	Infrared reflow soldering
		300°C within 5 seconds	Soldering iron
	Thermal shock resistance (header and socket mated)	5 cycles, insulation resistance min. 100MΩ, contact resistance max. 80mΩ	Sequence 1. -55 <sup>±</sup> °C, 30 minutes 2. ~, Max. 5 minutes 3. 85 <sup>±</sup> °C, 30 minutes 4. ~, Max. 5 minutes
	Humidity resistance (header and socket mated)	120 hours, insulation resistance min. 100MΩ, contact resistance max. 80mΩ	Bath temperature 40±2°C, humidity 90 to 95% R.H.
	Saltwater spray resistance (header and socket mated)	24 hours, insulation resistance min. 100MΩ, contact resistance max. 80mΩ	Bath temperature 35±2°C, saltwater concentration 5±1%
	H <sub>2</sub> S resistance (header and socket mated)	48 hours, contact resistance max. 80mΩ	Bath temperature 40±2°C, gas concentration 3±1 ppm, humidity 75 to 80% R.H.
SO <sub>2</sub> resistance (header and socket mated)	48 hours, contact resistance max. 80mΩ	Bath temperature 40±2°C, gas concentration 10±3 ppm, humidity 90 to 95% R.H.	
Lifetime characteristics	Insertion and removal life	20 times	Repeated insertion and removal speed of max. 200 times/hours
Unit weight	30 contacts; Socket: 0.19g Header: 0.32g 50 contacts; Socket: 0.29g Header: 0.50g		

### 2. Material and surface treatment

Part name	Material	Surface treatment
Molded portion	Heat-resistant resin (UL94V-0)	—
Contact/post	Copper alloy	Contact portion: Ni plating on base, Au plating on surface Terminal portion: Ni plating on base, Au plating on surface (Except for thick of terminal)

## DIMENSIONS (Unit: mm)

The CAD data of the products with a **CAD Data** mark can be downloaded from: <http://panasonic-electric-works.net/ac>

### • Socket

#### CAD Data

#### Recommended PC board pattern (TOP VIEW)



**Dimension table (mm)**

No. of contacts	A	B
20	7.40	4.50
30	9.90	7.00
40	12.40	9.50
50	14.90	12.00
60	17.40	14.50
80	22.40	19.50
100	27.40	24.50

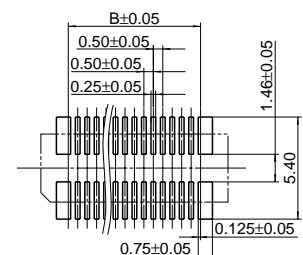
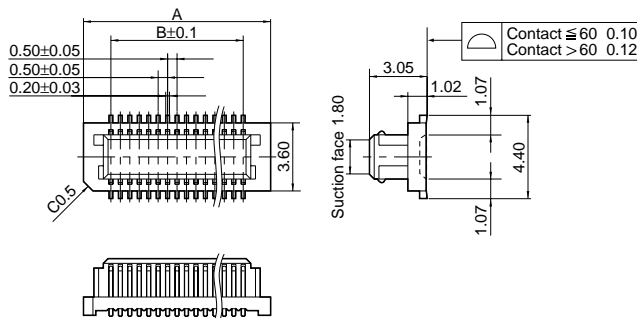

General tolerance: ±0.2

• Header

**CAD Data**



**Dimension table (mm)**

No. of contacts	A	B
20	7.40	4.50
30	9.90	7.00
40	12.40	9.50
50	14.90	12.00
60	17.40	14.50
80	22.40	19.50
100	27.40	24.50

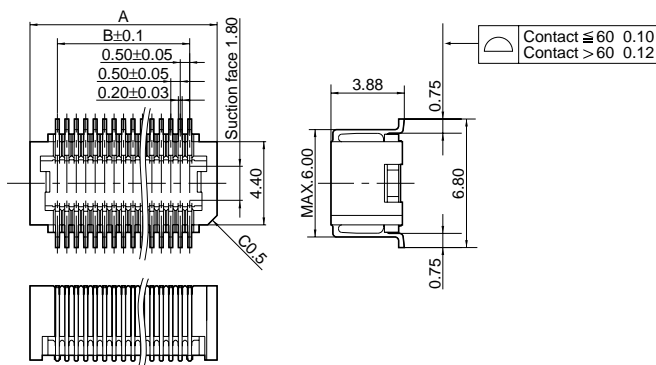

**Recommended PC board pattern (TOP VIEW)**

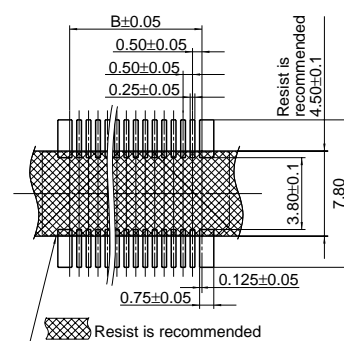

General tolerance:  $\pm 0.2$

• Socket and Header are mated

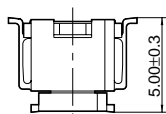

**EMBOSSED TAPE DIMENSIONS** (unit: mm, Common for respective contact type, socket and header)

• Tape dimensions (Conforming to JIS C 0806-1990.

• Plastic reel dimensions (Conforming to EIAJ ET-7200B)

However, some tapes have mounting hole pitches that do not comply with the standard.)

Tape I

Tape II

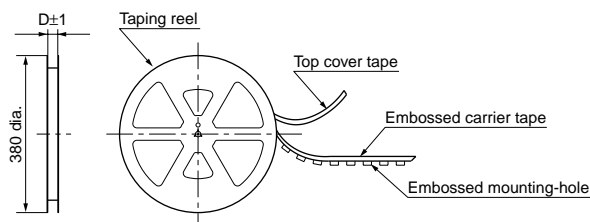
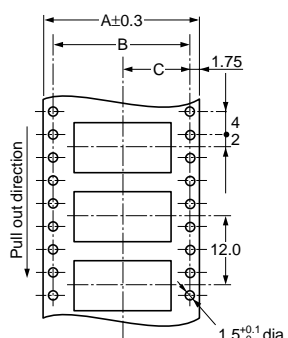
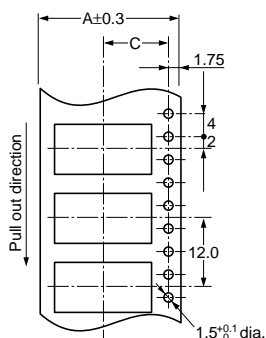

**Dimension table (mm)**

Mated height	No. of contacts	Type of taping	A	B	C	D	Quantity per reel
Socket and header are common: 5.0mm	20 to 60	Tape I	24.0	—	11.5	25.4	1,000
	80	Tape II	32.0	28.4	14.2	33.4	1,000
	100	Tape II	44.0	40.4	20.2	45.4	1,000

**Connector orientation with respect to direction of progress of embossed tape**

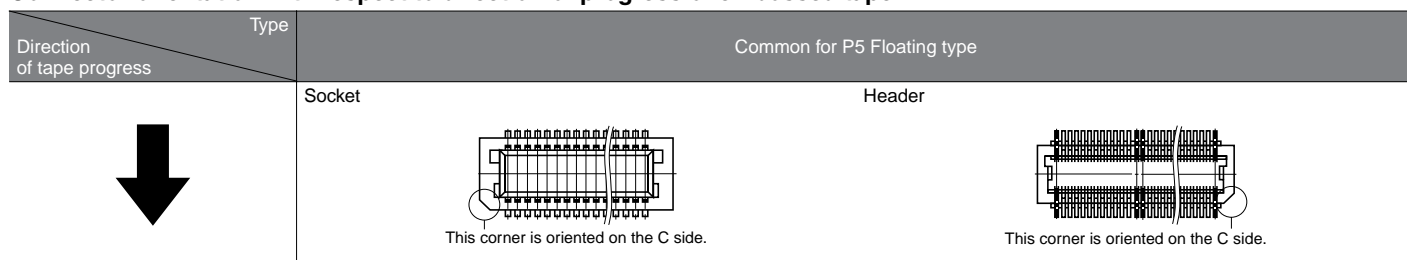

## NOTES

### 1. Preventing vibration and shock

To prevent the PC board from drop-off faults and to protect soldered spots from direct stress, use vibration-proof pads across boards.

Fix the PC boards in place or install a stopper so that the gap between the connectors is less than 0.5 mm and that their mating is level.

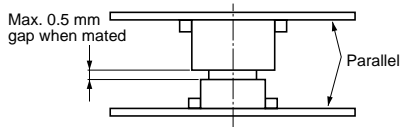

### 2. Prevention of reverse mating

The socket and header are protected from reverse mating by a molded resin key. Excessive mating force may damage the key, so be sure to match chamfered corners when mating.

### • Floating type

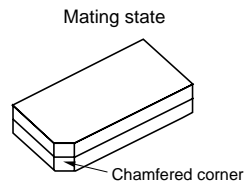

### 3. Static electricity

This type of socket has the terminals exposed from the connector walls, and therefore if they are touched with anything metal, a short circuit will occur. Also, if the terminals are touched by hand, the static electricity may damage the IC.

### 4. About floating-type connectors

(1) When two floating-type connectors are used on header, distance tolerance between connectors is 0.3mm max.

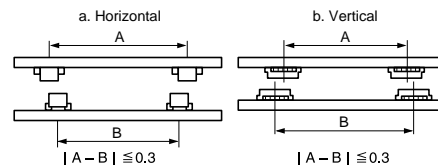

(2) If rotational error exists between two connectors, distance tolerance between the two connectors is as follows:

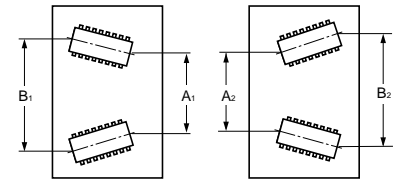

$$|A_1 - A_2| \leq 0.3$$

$$|B_1 - B_2| \leq 0.3$$

However, A1 is mated with A2, and B1 is mated with B2.

(3) Please consult us regarding allowable installation pitch tolerance between connectors when using two connectors that have differing number of terminals.

**For other details, please verify with the product specification sheets.**