

FEATURES

DAC update rate up to 12 GSPS (minimum)

Direct RF synthesis at 6 GSPS (minimum)

DC to 3 GHz in nonreturn-to-zero (NRZ) mode

DC to 6 GHz in 2× NRZ mode

1.5 GHz to 7.5 GHz in Mix-Mode

Selectable interpolation

6×, 8×, 12×, 16×, 24×

Excellent dynamic performance

APPLICATIONS

Broadband communications systems

**DOCSIS 3.1 cable modem termination system (CMTS)/
video on demand (VOD)/edge quadrature amplitude
modulation (EQAM)**

Wireless communications infrastructure

MC-GSM, W-CDMA, LTE, LTE-A, point to point

GENERAL DESCRIPTION

The AD9163¹ is a high performance, 16-bit digital-to-analog converter (DAC) that supports data rates to 6 GSPS. The DAC core is based on a quad-switch architecture coupled with a 2× interpolator filter that enables an effective DAC update rate of up to 12 GSPS in some modes. The high dynamic range and bandwidth makes this DAC ideally suited for the most demanding high speed radio frequency (RF) DAC applications.

Superior RF performance and deep interpolation rates enable use of the AD9163 in many wireless infrastructure applications, including MC-GSM, W-CDMA, LTE, and LTE-A.

The wide bandwidth of up to 1 GHz and the complex NCO and digital upconverter enable dual band and triple band direct RF synthesis of wireless infrastructure signals, eliminating costly analog upconverters.

Wide analog bandwidth capability combines with high dynamic range to support DOCSIS 3.1 cable infrastructure compliance from the minimum of one carrier up to 1 GHz of signal bandwidth, making it ideal for cable multiple dwelling unit (MDU) applications. A 2× interpolator filter (FIR85) enables the AD9163 to be configured for lower data rates and converter clocking to reduce the overall system power and ease the filtering requirements. In Mix-Mode™ operation, the AD9163 can reconstruct RF carriers in the second and third Nyquist zones up to 7.5 GHz while still maintaining exceptional dynamic range. The output current can be programmed from 8 mA to 38.76 mA. The AD9163 data interface consists of up to eight JESD204B serializer/deserializer (SERDES) lanes that are programmable in terms of lane speed and number of lanes to enable application flexibility.

A serial peripheral interface (SPI) configures the AD9163 and monitors the status of all the registers. The AD9163 is offered in a 169-ball, 11 mm × 11 mm, 0.8 mm pitch CSP_BGA package.

PRODUCT HIGHLIGHTS

1. High dynamic range and signal reconstruction bandwidth supports RF signal synthesis of up to 7.5 GHz.
2. Up to eight lanes JESD204B SERDES interface, flexible in terms of number of lanes and lane speed.
3. Bandwidth and dynamic range to meet multiband wireless communications standards with margin.

FUNCTIONAL BLOCK DIAGRAM

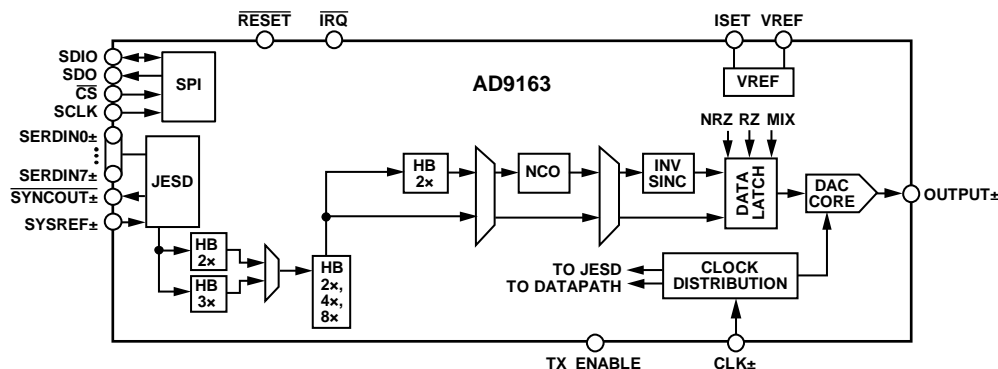

Figure 1.

14415-001

¹ Protected by U.S. Patents 6,842,132 and 7,796,971.

TABLE OF CONTENTS

Features	1	JESD204B Serial Data Interface.....	31
Applications.....	1	JESD204B Overview	31
General Description	1	Physical Layer	32
Product Highlights	1	Data Link Layer	35
Functional Block Diagram	1	Transport Layer	43
Revision History	3	JESD204B Test Modes	45
Specifications.....	4	JESD204B Error Monitoring.....	47
DC Specifications	4	Hardware Considerations	49
DAC Input Clock Overclocking Specifications.....	5	Main Digital Datapath	50
Power Supply DC Specifications	5	Data Format	50
Serial Port and CMOS Pin Specifications	6	Interpolation Filters	50
JESD204B Serial Interface Speed Specifications	7	Digital Modulation.....	53
SYSREF± to DAC Clock Timing Specifications.....	7	Inverse Sinc	55
Digital Input Data Timing Specifications	8	Downstream Protection	55
JESD204B Interface Electrical Specifications	8	Datapath PRBS	56
AC Specifications.....	9	Datapath PRBS IRQ.....	56
Absolute Maximum Ratings.....	10	Interrupt Request Operation	58
Reflow Profile.....	10	Interrupt Service Routine.....	58
Thermal Management	10	Applications Information	59
Thermal Resistance	10	Hardware Considerations	59
ESD Caution.....	10	Analog Interface Considerations.....	62
Pin Configuration and Function Descriptions.....	11	Analog Modes of Operation	62
Typical Performance Characteristics	13	Clock Input.....	63
Static Linearity	13	Shuffle Mode.....	64
AC Performance (NRZ Mode)	14	DLL.....	64
AC (Mix-Mode).....	19	Voltage Reference	64
DOCSIS Performance (NRZ Mode).....	22	Temperature Sensor	65
Terminology	27	Analog Outputs	65
Theory of Operation	28	Start-Up Sequence	67
Serial Port Operation	29	Register Summary	69
Data Format	29	Register Details	76
Serial Port Pin Descriptions.....	29	Outline Dimensions	126
Serial Port Options.....	29	Ordering Guide	126

REVISION HISTORY**7/2017—Rev. B to Rev. C**

Changes to Table 44	74
Changes to Table 45	118

5/2017—Rev. A to Rev. B

Changes to Start-Up Sequence Section	67
--	----

2/2017—Rev. 0 to Rev. A

Change to Endnote 1, Table 1	4
Added Temperature Sensor Parameter, Table 1	4
Change to OUTPUT± to VNEG_N1P2 Parameter, Table 10	10
Changes to Figure 99	38
Changes to Link Delay Setup Example, With Known Delays Section	40
Changes to Link Delay Setup Example, Without Known Delays Section	41

Changes to Table 23	43
Changed 4× Six-Lane (L = 3, M = 2, F = 4, S = 3) to 4× Three-Lane (L = 3, M = 2, F = 4, S = 3), Table 29	46
Added Datapath PRBS Section and Datapath PRBS IRQ Section	56
Moved Figure 133	64
Added Temperature Sensor Section	65
Changes to Equivalent DAC Output and Transfer Function Section	65
Changes to Output Stage Configuration Section and Figure 140 Caption	66
Added Register 0x132 Row to Register 0x135 Row, Table 44	70
Added Register 0x132 Row to Register 0x135 Row, Table 45	84
Change to Register 0x230	86

7/2016—Revision 0: Initial Version

SPECIFICATIONS

DC SPECIFICATIONS

VDD25_DAC = 2.5 V, VDD12A = VDD12_CLK = 1.2 V, VNEG_N1P2 = -1.2 V, DVDD = 1.2 V, IOVDD = 2.5 V, VDD_1P2 = DVDD_1P2 = PLL_LDO_VDD12 = 1.2 V, SYNC_VDD_3P3 = 3.3 V, DAC output full-scale current (I_{OUTFS}) = 40 mA, and T_A = -40°C to +85°C, unless otherwise noted.

Table 1.

Parameter	Test Conditions/Comments	Min	Typ	Max	Unit
RESOLUTION		16			Bit
DAC Update Rate				1.5	GSPS
Minimum	VDDx ¹ = 1.3 V ± 2% ²	6	6.4		GSPS
Maximum	VDDx ¹ = 1.3 V ± 2% ² , FIR85 ³ 2× interpolator enabled	12	12.8		GSPS
Adjusted ⁴	VDDx ¹ = 1.3 V ± 2% ²	1	1.0667		GSPS
ACCURACY					
Integral Nonlinearity (INL)			±2.7		LSB
Differential Nonlinearity (DNL)			±1.7		LSB
ANALOG OUTPUTS					
Gain Error (with Internal Reference)			-1.7		%
Full-Scale Output Current					
Minimum	R _{SET} = 9.76 kΩ	7.37	8	8.57	mA
Maximum	R _{SET} = 9.76 kΩ	35.8	38.76	41.3	mA
DAC CLOCK INPUT (CLK+, CLK-)					
Differential Input Power	R _{LOAD} = 90 Ω differential on chip	-20	0	+10	dBm
Common-Mode Voltage	AC-coupled		0.6		V
Input Impedance ¹	3 GSPS input clock		90		Ω
TEMPERATURE DRIFT					
Gain			105		ppm/°C
Reference Voltage			75		ppm/°C
TEMPERATURE SENSOR					
Accuracy	After single point calibration (see the Temperature Sensor section)		±5		%
REFERENCE					
Internal Reference Voltage			1.19		V
ANALOG SUPPLY VOLTAGES					
VDD25_DAC		2.375	2.5	2.625	V
VDD12A ²		1.14	1.2	1.326	V
VDD12_CLK ²		1.14	1.2	1.326	V
VNEG_N1P2		-1.26	-1.2	-1.14	V
DIGITAL SUPPLY VOLTAGES					
DVDD		1.14	1.2	1.326	V
IOVDD ³		1.71	2.5	3.465	V
SERDES SUPPLY VOLTAGES					
VDD_1P2		1.14	1.2	1.326	V
VTT_1P2	Can connect to VDD_1P2	1.14	1.2	1.326	V
DVDD_1P2		1.14	1.2	1.326	V
PLL_LDO_VDD12		1.14	1.2	1.326	V
PLL_CLK_VDD12	Can connect to PLL_LDO_VDD12	1.14	1.2	1.326	V
SYNC_VDD_3P3		3.135	3.3	3.465	V
BIAS_VDD_1P2	Can connect to VDD_1P2	1.14	1.2	1.326	V

¹ See the Clock Input section for more details.

² For the lowest noise performance, use a separate power supply filter network for the VDD12_CLK and the VDD12A pins.

³ IOVDD can range from 1.8 V to 3.3 V, with ±5% tolerance.

⁴ The adjusted DAC update rate is calculated as f_{DAC} divided by the minimum required interpolation factor. For the AD9163, the minimum interpolation factor is 6. Therefore, with $f_{DAC} = 6$ GSPS, f_{DAC} adjusted = 1 GSPS. When FIR85 is enabled, which puts the device into 2× NRZ mode, $f_{DAC} = 2 \times$ (DAC clock input frequency), and the minimum interpolation increases to 12× (interpolation value). Thus, for the AD9163, with FIR85 enabled and DAC clock = 6 GSPS, $f_{DAC} = 12$ GSPS, minimum interpolation = 12×, and the adjusted DAC update rate = 1 GSPS.

DAC INPUT CLOCK OVERCLOCKING SPECIFICATIONS

VDD25_DAC = 2.5 V, VDD12A = VDD12_CLK = 1.2 V, VNEG_N1P2 = -1.2 V, DVDD = 1.2 V, IOVDD = 2.5 V, VDD_1P2 = DVDD_1P2 = PLL_LDO_VDD12 = 1.2 V, SYNC_VDD_3P3 = 3.3 V, I_{OUTFS} = 40 mA, T_A = -40°C to +85°C, unless otherwise noted.

Maximum guaranteed speed using the temperatures and voltages conditions as shown in Table 2, where VDDx is VDD12_CLK, DVDD, VDD_1P2, DVDD_1P2, and PLL_LDO_VDD12. Any DAC clock speed over 5.1 GSPS requires a maximum junction temperature of 105°C to avoid damage to the device. See Table 10 for details on maximum junction temperature permitted for certain clock speeds.

Table 2.

Parameter ¹	Test Conditions/Comments	Min	Typ	Max	Unit
MAXIMUM DAC UPDATE RATE VDDx = 1.2 V ± 5%	T _{JMAX} = 25°C	6.0			GSPS
	T _{JMAX} = 85°C	5.6			GSPS
	T _{JMAX} = 105°C	5.4			GSPS
VDDx = 1.2 V ± 2%	T _{JMAX} = 25°C	6.1			GSPS
	T _{JMAX} = 85°C	5.8			GSPS
	T _{JMAX} = 105°C	5.6			GSPS
VDDx = 1.3 V ± 2%	T _{JMAX} = 25°C	6.4			GSPS
	T _{JMAX} = 85°C	6.2			GSPS
	T _{JMAX} = 105°C	6.0			GSPS

¹ T_{JMAX} is the maximum junction temperature.

POWER SUPPLY DC SPECIFICATIONS

I_{OUTFS} = 40 mA, T_A = -40°C to +85°C, unless otherwise noted. FIR85 is the finite impulse response with 85 dB digital attenuation.

Table 3.

Parameter	Test Conditions/Comments	Min	Typ	Max	Unit
8 LANES, 6× INTERPOLATION (80%), 3 GSPS	NCO on, FIR85 on				
Analog Supply Currents					
VDD25_DAC = 2.5 V			93.8		mA
VDD12A = 1.2 V			3.7		μA
VDD12_CLK = 1.2 V			228.7		mA
VNEG_N1P2 = -1.2 V			-120.7		mA
Digital Supply Currents					
DVDD = 1.2 V			598.4		mA
IOVDD = 2.5 V			2.5		mA
SERDES Supply Currents					
VDD_1P2 = 1.2 V	Includes VTT_1P2, BIAS_VDD_1P2		443.4		mA
DVDD_1P2 = 1.2 V			72.3		mA
PLL_LDO_VDD12 = 1.2 V	Connected to PLL_CLK_VDD12		81.8		mA
SYNC_VDD_3P3 = 3.3 V			9.4		mA
8 LANES, 8× INTERPOLATION (80%), 5 GSPS	NCO on, FIR85 off (unless otherwise noted)				
Analog Supply Currents					
VDD25_DAC = 2.5 V			94	100	mA
VDD12A = 1.2 V			80	150	μA
VDD12_CLK = 1.2 V			341	435	mA
VNEG_N1P2 = -1.2 V		-119	-112		mA
Digital Supply Currents					
DVDD = 1.2 V	NCO on, FIR85 off		495	878	mA
IOVDD = 2.5 V			2.5	2.7	mA
SERDES Supply Currents					
VDD_1P2 = 1.2 V	Includes VTT_1P2, BIAS_VDD_1P2		477	681	mA
DVDD_1P2 = 1.2 V			89	130	mA
PLL_LDO_VDD12 = 1.2 V	Connected to PLL_CLK_VDD12		81	112	mA
SYNC_VDD_3P3 = 3.3 V			9.3	11	mA

Parameter	Test Conditions/Comments	Min	Typ	Max	Unit
POWER DISSIPATION					
3 GSPS					
2× NRZ Mode, 6×, FIR85 Enabled, NCO On	Using 80%, 3× filter, eight-lane JESD204B		2.1		W
NRZ Mode, 24×, FIR85 Disabled, NCO On	Using 80%, 2× filter, one-lane JESD204B		1.3		W
5 GSPS					
NRZ Mode, 8×, FIR85 Disabled, NCO On	Using 80%, 2× filter, eight-lane JESD204B		2.18		W
NRZ Mode, 16×, FIR85 Disabled, NCO On	Using 80%, 2× filter, eight-lane JESD204B		2.09		W
2× NRZ Mode, 6×, FIR85 Enabled, NCO On	Using 80%, 3× filter, eight-lane JESD204B		2.65		W

SERIAL PORT AND CMOS PIN SPECIFICATIONS

VDD25_DAC = 2.5 V, VDD12A = VDD12_CLK = 1.2 V, VNEG_N1P2 = -1.2 V, DVDD = 1.2 V, IOVDD = 2.5 V, VDD_1P2 = DVDD_1P2 = PLL_LDO_VDD12 = 1.2 V, SYNC_VDD_3P3 = 3.3 V, I_{OUTFS} = 40 mA, T_A = -40°C to +85°C, unless otherwise noted.

Table 4.

Parameter	Symbol	Test Comments/Conditions	Min	Typ	Max	Unit
WRITE OPERATION						
Maximum SCLK Clock Rate	f _{SCLK} , 1/t _{SCLK}	See Figure 89	100			MHz
SCLK Clock High	t _{PWH}	SCLK = 20 MHz	3.5			ns
SCLK Clock Low	t _{PWL}	SCLK = 20 MHz	4			ns
SDIO to SCLK Setup Time	t _{DS}		4	2		ns
SCLK to SDIO Hold Time	t _{DH}		1	0.5		ns
$\overline{\text{CS}}$ to SCLK Setup Time	t _S		9	1		ns
SCLK to $\overline{\text{CS}}$ Hold Time	t _H		9	0.5		ns
READ OPERATION						
SCLK Clock Rate	f _{SCLK} , 1/t _{SCLK}	See Figure 88			20	MHz
SCLK Clock High	t _{PWH}		20			ns
SCLK Clock Low	t _{PWL}		20			ns
SDIO to SCLK Setup Time	t _{DS}		10			ns
SCLK to SDIO Hold Time	t _{DH}		5			ns
$\overline{\text{CS}}$ to SCLK Setup Time	t _S		10			ns
SCLK to SDIO (or SDO) Data Valid Time	t _{DV}				17	ns
$\overline{\text{CS}}$ to SDIO (or SDO) Output Valid to High-Z		Not shown in Figure 88 or Figure 89			45	ns
INPUTS (SDIO, SCLK, $\overline{\text{CS}}$, RESET, TX_ENABLE)						
Voltage Input						
High	V _{IH}	1.8 V ≤ IOVDD ≤ 2.5 V	0.7 × IOVDD			V
Low	V _{IL}	1.8 V ≤ IOVDD ≤ 2.5 V			0.3 × IOVDD	V
Current Input						
High	I _{IH}				75	μA
Low	I _{IL}		-150			μA
OUTPUTS (SDIO, SDO)						
Voltage Output						
High	V _{OH}	1.8 V ≤ IOVDD ≤ 3.3 V	0.8 × IOVDD			V
Low	V _{OL}	1.8 V ≤ IOVDD ≤ 3.3 V			0.2 × IOVDD	V
Current Output						
High	I _{OH}			4		mA
Low	I _{OL}			4		mA

JESD204B SERIAL INTERFACE SPEED SPECIFICATIONS

VDD25_DAC = 2.5 V, VDD12A = VDD12_CLK = 1.2 V, VNEG_N1P2 = -1.2 V, DVDD = 1.2 V, IOVDD = 2.5 V, VDD_1P2 = DVDD_1P2 = PLL_LDO_VDD12 = 1.2 V, SYNC_VDD_3P3 = 3.3 V, I_{OUTFS} = 40 mA, T_A = -40°C to +85°C, unless otherwise noted.

Table 5.

Parameter	Test Conditions/Comments	Min	Typ	Max	Unit
SERIAL INTERFACE SPEED	Guaranteed operating range				
Half Rate		6		12.5	Gbps
Full Rate		3		6.25	Gbps
Oversampling		1.5		3.125	Gbps
2× Oversampling		0.750		1.5625	Gbps

SYSREF± TO DAC CLOCK TIMING SPECIFICATIONS

VDD25_DAC = 2.5 V, VDD12A = VDD12_CLK = 1.2 V, VNEG_N1P2 = -1.2 V, DVDD = 1.2 V, IOVDD = 2.5 V, VDD_1P2 = DVDD_1P2 = PLL_LDO_VDD12 = 1.2 V, SYNC_VDD_3P3 = 3.3 V, I_{OUTFS} = 40 mA, T_A = -40°C to +85°C, unless otherwise noted.

Table 6.

Parameter ¹	Test Conditions/Comments	Min	Typ	Max	Unit
SYSREF± DIFFERENTIAL SWING = 1.0 V					
Minimum Setup Time, t _{SYSS}	AC-coupled		65	117	ps
	DC-coupled, common-mode voltage = 0 V		45	77	ps
	DC-coupled, common-mode voltage = 1.25 V		68	129	ps
Minimum Hold Time, t _{SYSH}	AC-coupled		19	63	ps
	DC-coupled, common-mode voltage = 0 V		5	37	ps
	DC-coupled, common-mode voltage = 1.25 V		51	114	ps

¹ The SYSREF± pulse must be at least four DAC clock edges wide plus the setup and hold times in Table 6. For more information, see the Sync Processing Modes Overview section.

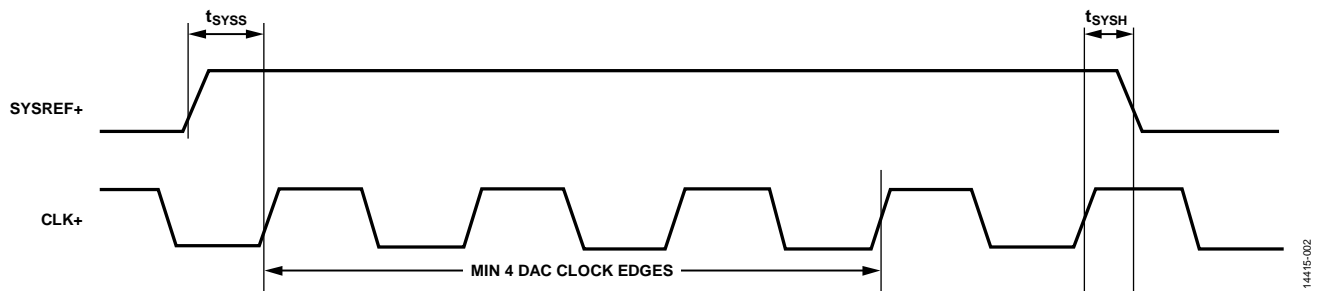

Figure 2. SYSREF± to DAC Clock Timing Diagram (Only SYSREF+ and CLK+ Shown)

DIGITAL INPUT DATA TIMING SPECIFICATIONS

VDD25_DAC = 2.5 V, VDD12A = VDD12_CLK = 1.2 V, VNEG_N1P2 = -1.2 V, DVDD = 1.2 V, IOVDD = 2.5 V, VDD_1P2 = DVDD_1P2 = PLL_LDO_VDD12 = 1.2 V, SYNC_VDD_3P3 = 3.3 V, I_{OUTFS} = 40 mA, T_A = -40°C to +85°C, unless otherwise noted.

Table 7.

Parameter	Test Conditions/Comments	Min	Typ	Max	Unit
LATENCY ¹					
Interface			1		PCLK ² cycle
Interpolation			See Table 32		
Power-Up Time	From DAC output off to enabled		10		ns
DETERMINISTIC LATENCY					
Fixed				12	PCLK ² cycles
Variable				2	PCLK ² cycles
SYSREF _± to LOCAL MULTIFRAME CLOCKS (LMFC) DELAY			4		DAC clock cycles

¹ Total latency (or pipeline delay) through the device is calculated as follows:

$$\text{Total Latency} = \text{Interface Latency} + \text{Fixed Latency} + \text{Variable Latency} + \text{Pipeline Delay}$$

See Table 32 for examples of the pipeline delay per block.

² PCLK is the internal processing clock for the AD9163 and equals the lane rate ÷ 40.

JESD204B INTERFACE ELECTRICAL SPECIFICATIONS

VDD25_DAC = 2.5 V, VDD12A = VDD12_CLK = 1.2 V, VNEG_N1P2 = -1.2 V, DVDD = 1.2 V, IOVDD = 2.5 V, VDD_1P2 = DVDD_1P2 = PLL_LDO_VDD12 = 1.2 V, SYNC_VDD_3P3 = 3.3 V, I_{OUTFS} = 40 mA, T_A = -40°C to +85°C, unless otherwise noted. V_{TT} is the termination voltage.

Table 8.

Parameter	Symbol	Test Conditions/Comments	Min	Typ	Max	Unit
JESD204B DATA INPUTS						
Input Leakage Current		T _A = 25°C				
Logic High		Input level = 1.2 V ± 0.25 V, V _{TT} = 1.2 V		10		μA
Logic Low		Input level = 0 V		-4		μA
Unit Interval	UI		80		1333	ps
Common-Mode Voltage	V _{RCM}	AC-coupled, V _{TT} = VDD_1P2 ¹	-0.05		+1.85	V
Differential Voltage	R _{VDIFF}		110		1050	mV
V _{TT} Source Impedance	Z _{TT}	At dc			30	Ω
Differential Impedance	Z _{RDIFF}	At dc	80	100	120	Ω
Differential Return Loss	RL _{RDIF}			8		dB
Common-Mode Return Loss	RL _{RCM}			6		dB
SYSREF _± INPUT						
Differential Impedance		169-ball CSP_BGA		121		Ω
DIFFERENTIAL OUTPUTS (SYNCOUT _±) ²		Driving 100 Ω differential load				
Output Differential Voltage	V _{OD}		350	420	450	mV
Output Offset Voltage	V _{OS}		1.15	1.2	1.27	V

¹ As measured on the input side of the ac coupling capacitor.

² IEEE Standard 1596.3 LVDS compatible.

AC SPECIFICATIONS

VDD25_DAC = 2.5 V, VDD12A = VDD12_CLK = 1.2 V, VNEG_N1P2 = -1.2 V, DVDD = 1.2 V, IOVDD = 2.5 V, VDD_1P2 = DVDD_1P2 = PLL_LDO_VDD12 = 1.2 V, SYNC_VDD_3P3 = 3.3 V, I_{OUTFS} = 40 mA, T_A = 25°C, unless otherwise noted.

Table 9. AC Specifications

Parameter	Test Conditions/Comments	Min	Typ	Max	Unit
SPURIOUS-FREE DYNAMIC RANGE (SFDR)¹					
Single Tone, f _{DAC} = 5000 MSPS					
f _{OUT} = 70 MHz			-82		dBc
f _{OUT} = 500 MHz			-75		dBc
f _{OUT} = 1000 MHz			-65		dBc
f _{OUT} = 2000 MHz			-70		dBc
f _{OUT} = 4000 MHz	FIR85 enabled		-60		dBc
Single Tone, f _{DAC} = 5000 MSPS	-6 dBFS, shuffle enabled				
f _{OUT} = 70 MHz			-75		dBc
f _{OUT} = 500 MHz			-75		dBc
f _{OUT} = 1000 MHz			-70		dBc
f _{OUT} = 2000 MHz			-75		dBc
f _{OUT} = 4000 MHz	FIR85 enabled		-65		dBc
DOCSIS					
f _{DAC} = 3076 MSPS					
f _{OUT} = 70 MHz	Single carrier		-70		dBc
f _{OUT} = 70 MHz	Four carriers		-70		dBc
f _{OUT} = 70 MHz	Eight carriers		-67		dBc
f _{OUT} = 950 MHz	Single carrier		-70		dBc
f _{OUT} = 950 MHz	Four carriers		-68		dBc
f _{OUT} = 950 MHz	Eight carriers		-64		dBc
Wireless Infrastructure					
f _{DAC} = 5000 MSPS					
f _{OUT} = 960 MHz	Two-carrier GSM signal at -9 dBFS; across 925 MHz to 960 MHz band		-85		dBc
f _{OUT} = 1990 MHz	Two-carrier GSM signal at -9 dBFS; across 1930 MHz to 1990 MHz band		-81		dBc
ADJACENT CHANNEL POWER					
f _{DAC} = 5000 MSPS					
f _{OUT} = 877 MHz	One carrier, first adjacent channel		-79		dBc
f _{OUT} = 877 MHz	Two carriers, first adjacent channel		-76		dBc
f _{OUT} = 1887 MHz	One carrier, first adjacent channel		-74		dBc
f _{OUT} = 1980 MHz	Four carriers, first adjacent channel		-70		dBc
INTERMODULATION DISTORTION					
f _{DAC} = 5000 MSPS, two-tone test					
f _{OUT} = 900 MHz	0 dBFS		-80		dBc
f _{OUT} = 900 MHz	-6 dBFS, shuffle enabled		-80		dBc
f _{OUT} = 1800 MHz	0 dBFS		-68		dBc
f _{OUT} = 1800 MHz	-6 dBFS, shuffle enabled		-78		dBc
NOISE SPECTRAL DENSITY (NSD)					
Single Tone, f _{DAC} = 5000 MSPS					
f _{OUT} = 550 MHz			-168		dBm/Hz
f _{OUT} = 960 MHz			-167		dBm/Hz
f _{OUT} = 1990 MHz			-164		dBm/Hz
SINGLE SIDEBAND (SSB) PHASE NOISE AT OFFSET					
f _{OUT} = 3800 MHz, f _{DAC} = 4000 MSPS					
1 kHz			-119		dBc/Hz
10 kHz			-125		dBc/Hz
100 kHz			-135		dBc/Hz
1 MHz			-144		dBc/Hz
10 MHz			-156		dBc/Hz

¹ See the Clock Input section for more details on optimizing SFDR and reducing the image of the fundamental with clock input tuning.

ABSOLUTE MAXIMUM RATINGS

Table 10.

Parameter	Rating
ISET, VREF to VBG_NEG	−0.3 V to VDD25_DAC + 0.3 V
SERDIN _{x±} , VTT_1P2, SYNCOU _{t±}	−0.3 V to SYNC_VDD_3P3 + 0.3 V
OUTPUT _± to VNEG_N1P2	−0.3 V to VDD25_DAC + 0.2 V
SYSREF _±	GND − 0.5 V to +2.5 V
CLK _± to Ground	−0.3 V to VDD12_CLK + 0.3 V
RESET, IRQ, CS, SCLK, SDIO, SDO to Ground	−0.3 V to IOVDD + 0.3 V
Junction Temperature ¹	
f _{DAC} = 6 GSPS	105°C
f _{DAC} ≤ 5.1 GSPS	110°C
Ambient Operating Temperature Range (T _A)	−40°C to +85°C
Storage Temperature Range	−65°C to +150°C

¹ Some operating modes of the device may cause the device to approach or exceed the maximum junction temperature during operation at supported ambient temperatures. Removal of heat from the device may require additional measures such as active airflow, heat sinks, or other measures.

Stresses at or above those listed under Absolute Maximum Ratings may cause permanent damage to the product. This is a stress rating only; functional operation of the product at these or any other conditions above those indicated in the operational section of this specification is not implied. Operation beyond the maximum operating conditions for extended periods may affect product reliability.

REFLOW PROFILE

The AD9163 reflow profile is in accordance with the JEDEC JESD204B criteria for Pb-free devices. The maximum reflow temperature is 260°C.

THERMAL MANAGEMENT

The AD9163 is a high power device that can dissipate nearly 3 W depending on the user application and configuration. Because of the power dissipation, the AD9163 uses an exposed die package to give the customer the most effective method of controlling the die temperature. The exposed die allows cooling of the die directly.

Figure 3 shows the profile view of the device mounted to a user printed circuit board (PCB) and a heat sink (typically the aluminum case) to keep the junction (exposed die) below the maximum junction temperature in Table 10.

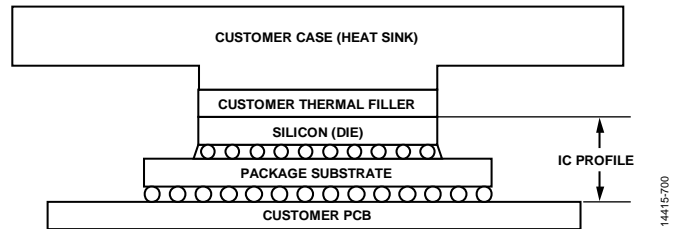

Figure 3. Typical Thermal Management Solution

THERMAL RESISTANCE

Typical θ_{JA} and θ_{JC} values are specified for a 4-layer JEDEC 2S2P high effective thermal conductivity test board for balled surface-mount packages. θ_{JA} is obtained in still air conditions (JESD51-2). Airflow increases heat dissipation, effectively reducing θ_{JA} . θ_{JC} is obtained with the test case temperature monitored at the bottom of the package.

Ψ_{JT} is thermal characteristic parameters obtained with θ_{JA} in still air test conditions but are not applicable to the CSP_BGA package.

Estimate the junction temperature (T_J) using the following equations:

$$T_J = T_T + (\Psi_{JT} \times P_{DISS})$$

where:

T_T is the temperature measured at the top of the package.

P_{DISS} is the total device power dissipation.

Table 11. Thermal Resistance

Package Type	θ_{JA}	θ_{JC}	Unit
BC-169-2	14.6	0.02	°C/W

ESD CAUTION



ESD (electrostatic discharge) sensitive device. Charged devices and circuit boards can discharge without detection. Although this product features patented or proprietary protection circuitry, damage may occur on devices subjected to high energy ESD. Therefore, proper ESD precautions should be taken to avoid performance degradation or loss of functionality.

PIN CONFIGURATION AND FUNCTION DESCRIPTIONS

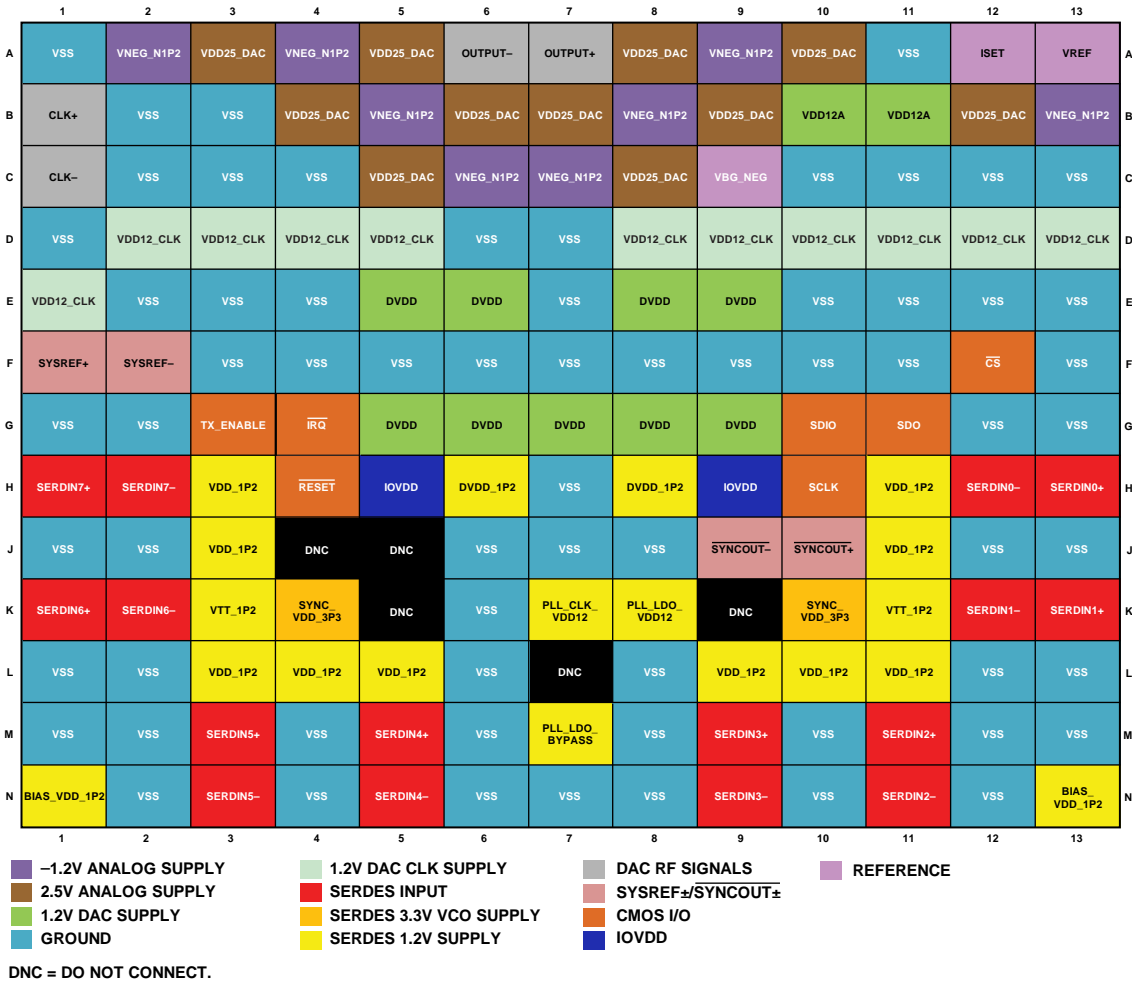

Figure 4. 169-Ball CSP_BGA Pin Configuration

14415-004

Table 12. 169-Ball CSP_BGA Pin Function Descriptions

Pin No.	Mnemonic	Description
A1, A11, B2, B3, C2, C3, C4, C10, C11, C12, C13, D1, D6, D7, E2, E3, E4, E7, E10, E11, E12, E13, F3, F4, F5, F6, F7, F8, F9, F10, F11, F13, G1, G2, G12, G13, H7, J1, J2, J6, J7, J8, J12, J13, K6, L1, L2, L6, L8, L12, L13, M1, M2, M4, M6, M8, M10, M12, M13, N2, N4, N6, N7, N8, N10, N12	VSS	Supply Return. Connect these pins to ground.
A2, A4, A9, B5, B8, B13, C6, C7	VNEG_N1P2	-1.2 V Analog Supply Voltage.
A3, A5, A8, A10, B4, B6, B7, B9, B12, C5, C8	VDD25_DAC	2.5 V Analog Supply Voltage.
A6	OUTPUT-	DAC Negative Current Output.
A7	OUTPUT+	DAC Positive Current Output.
A12	ISET	Reference Current. Connect this pin to VNEG_N1P2 with a 9.6 kΩ resistor.
A13	VREF	1.2 V Reference Input/Output. Connect this pin to VSS with a 1 μF capacitor.
B1, C1	CLK+, CLK-	Positive and Negative DAC Clock Inputs.
B10, B11	VDD12A	1.2 V Analog Supply Voltage.
C9	VBG_NEG	-1.2 V Reference. Connect this pin to VNEG_N1P2 with a 0.1 μF capacitor.
D2, D3, D4, D5, D8, D9, D10, D11, D12, D13, E1	VDD12_CLK	1.2 V Clock Supply Voltage.
E5, E6, E8, E9, G5, G6, G7, G8, G9	DVDD	1.2 V Digital Supply Voltage.

Pin No.	Mnemonic	Description
F1, F2	SYSREF+, SYSREF-	System Reference Positive and Negative Inputs. These pins are self biased for ac coupling. They can be ac-coupled or dc-coupled.
F12	$\overline{\text{CS}}$	Serial Port Chip Select Bar (Active Low) Input. CMOS levels on this pin are determined with respect to IOVDD.
G3	TX_ENABLE	Transmit Enable Input. This pin can be used instead of the DAC output bias power-down bits in Register 0x040, Bits[1:0] to enable the DAC output. CMOS levels are determined with respect to IOVDD.
G4	$\overline{\text{IRQ}}$	Interrupt Request Output (Active Low, Open Drain).
G10	SDIO	Serial Port Data Input/Output. CMOS levels on this pin are determined with respect to IOVDD.
G11	SDO	Serial Port Data Output. CMOS levels on this pin are determined with respect to IOVDD.
H10	SCLK	Serial Port Data Clock. CMOS levels on this pin are determined with respect to IOVDD.
H3, H11, J3, J11, L3, L4, L5, L9, L10, L11 H4	VDD_1P2 $\overline{\text{RESET}}$	1.2 V SERDES Digital Supply. Reset Bar (Active Low) Input. CMOS levels on this pin are determined with respect to IOVDD.
H5, H9	IOVDD	Supply Voltage for CMOS Input/Output and SPI. Operational for 1.8 V to 3.3 V (see Table 1 for details).
H6, H8 H1, H2	DVDD_1P2 SERDIN7+, SERDIN7-	1.2 V SERDES Digital Supply Voltage. SERDES Lane 7 Positive and Negative Inputs.
K1, K2	SERDIN6+, SERDIN6-	SERDES Lane 6 Positive and Negative Inputs.
M3, N3	SERDIN5+, SERDIN5-	SERDES Lane 5 Positive and Negative Inputs.
M5, N5	SERDIN4+, SERDIN4-	SERDES Lane 4 Positive and Negative Inputs.
M9, N9	SERDIN3+, SERDIN3-	SERDES Lane 3 Positive and Negative Inputs.
M11, N11	SERDIN2+, SERDIN2-	SERDES Lane 2 Positive and Negative Inputs.
K12, K13	SERDIN1-, SERDIN1+	SERDES Lane 1 Negative and Positive Inputs.
H12, H13	SERDIN0-, SERDIN0+	SERDES Lane 0 Negative and Positive Inputs.
J4, J5, K5, K9, L7 J9, J10	DNC $\overline{\text{SYNCOUT-}}$, $\overline{\text{SYNCOUT+}}$	Do Not Connect. Do not connect to these pins. Negative and Positive LVDS Sync (Active Low) Output Signals.
K3, K11	VTT_1P2	1.2 V SERDES V_{TT} Digital Supply Voltage.
K4, K10	SYNC_VDD_3P3	3.3 V SERDES Sync Supply Voltage.
K7	PLL_CLK_VDD12	1.2 V SERDES PLL Clock Supply Voltage.
K8	PLL_LDO_VDD12	1.2 V SERDES PLL Supply.
M7	PLL_LDO_BYPASS	1.2 V SERDES PLL Supply Voltage Bypass.
N1, N13	BIAS_VDD_1P2	1.2 V SERDES Supply Voltage.

TYPICAL PERFORMANCE CHARACTERISTICS

STATIC LINEARITY

$I_{OUTFS} = 40\text{ mA}$, nominal supplies, $T_A = 25^\circ\text{C}$, unless otherwise noted.

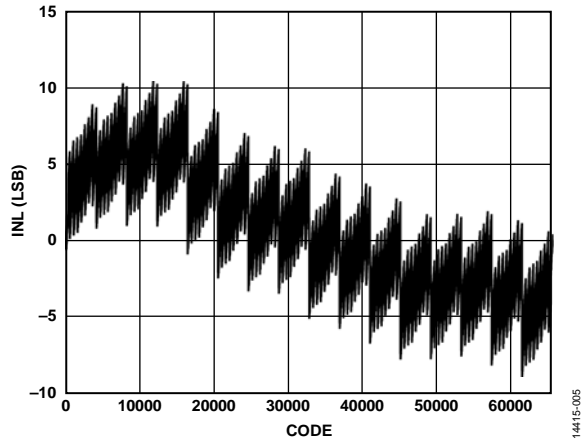

Figure 5. INL, $I_{OUTFS} = 20\text{ mA}$

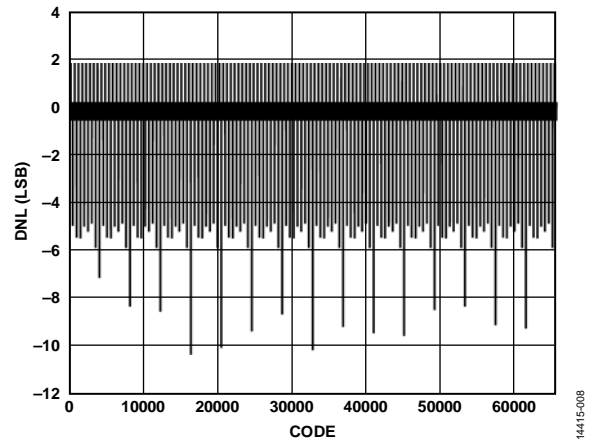

Figure 8. DNL, $I_{OUTFS} = 20\text{ mA}$

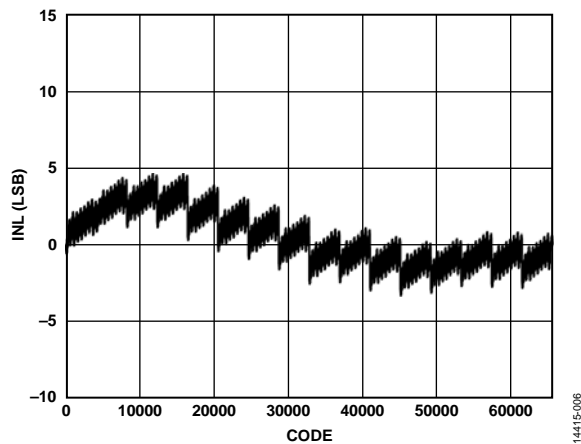

Figure 6. INL, $I_{OUTFS} = 30\text{ mA}$

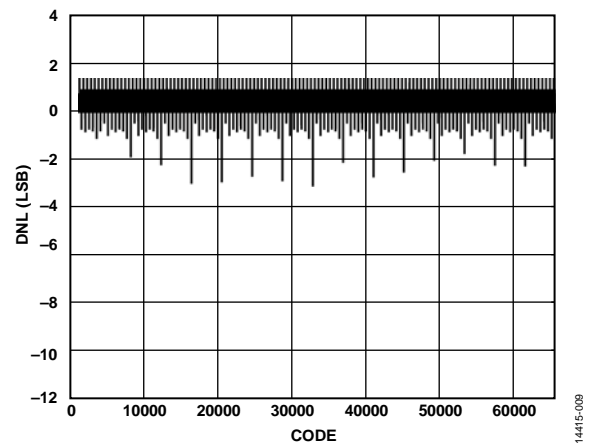

Figure 9. DNL, $I_{OUTFS} = 30\text{ mA}$

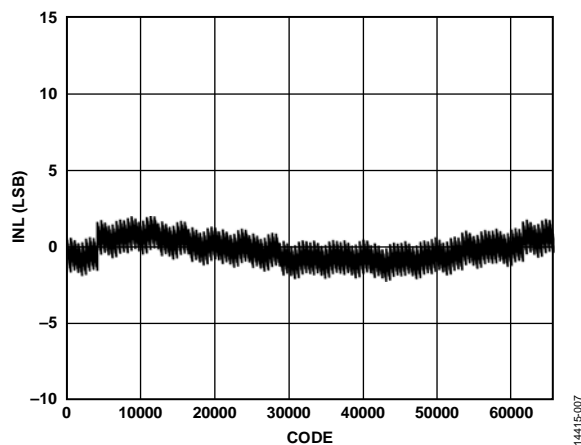

Figure 7. INL, $I_{OUTFS} = 40\text{ mA}$

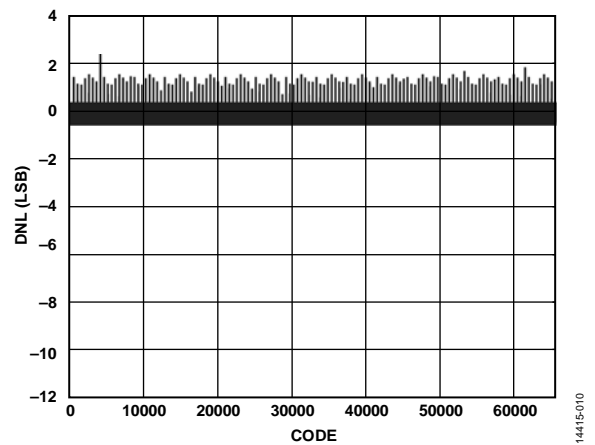

Figure 10. DNL, $I_{OUTFS} = 40\text{ mA}$

AC PERFORMANCE (NRZ MODE)

$I_{OUTFS} = 40\text{ mA}$, $f_{DAC} = 5.0\text{ GSPS}$, nominal supplies, $T_A = 25^\circ\text{C}$, unless otherwise noted.

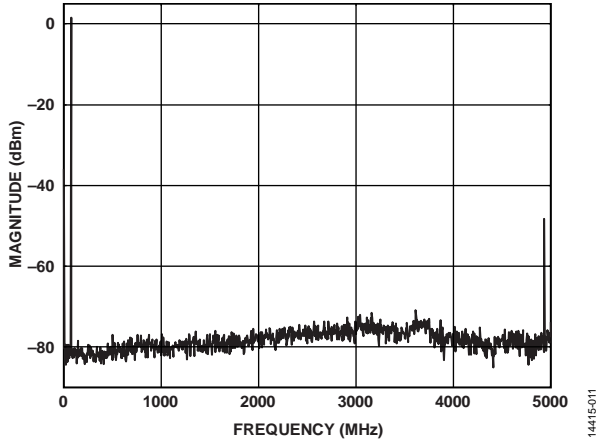

Figure 11. Single-Tone Spectrum at $f_{OUT} = 70\text{ MHz}$

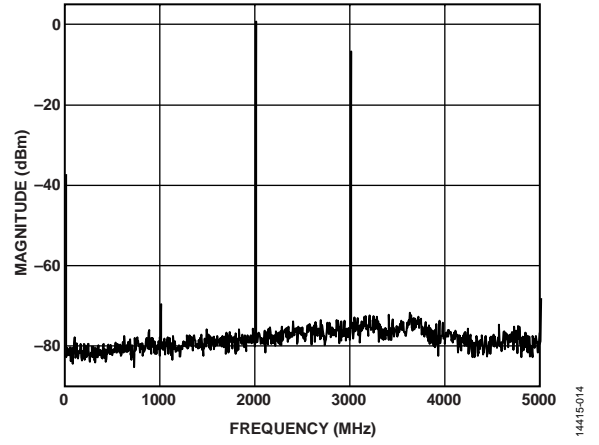

Figure 14. Single-Tone Spectrum at $f_{OUT} = 2000\text{ MHz}$

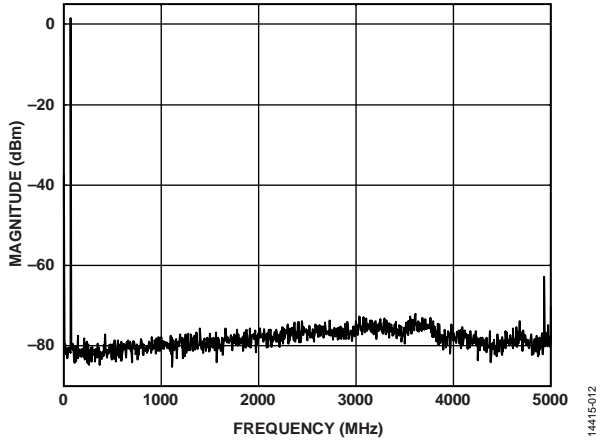

Figure 12. Single-Tone Spectrum at $f_{OUT} = 70\text{ MHz}$ (FIR85 Enabled)

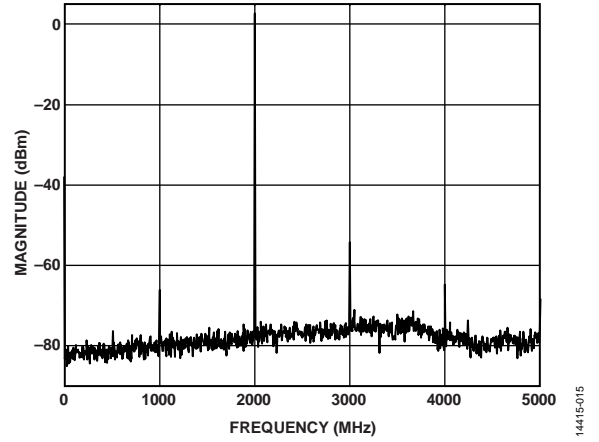

Figure 15. Single-Tone Spectrum at $f_{OUT} = 2000\text{ MHz}$ (FIR85 Enabled)

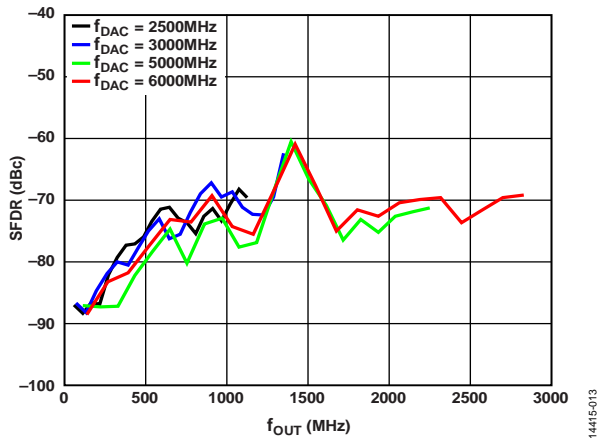

Figure 13. SFDR vs. f_{OUT} over f_{DAC}

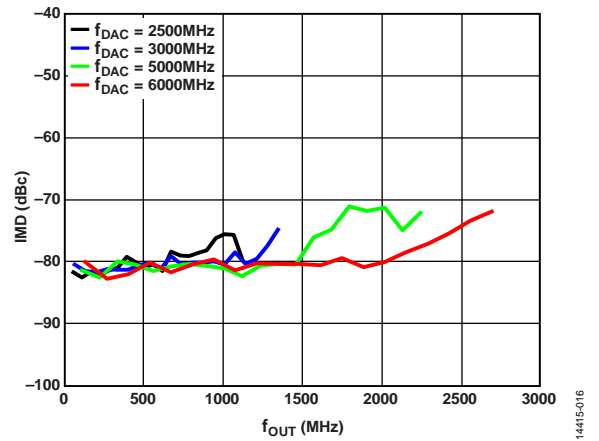

Figure 16. IMD vs. f_{OUT} over f_{DAC}

$I_{OUTFS} = 40 \text{ mA}$, $f_{DAC} = 5.0 \text{ GSPS}$, nominal supplies, $T_A = 25^\circ\text{C}$, unless otherwise noted.

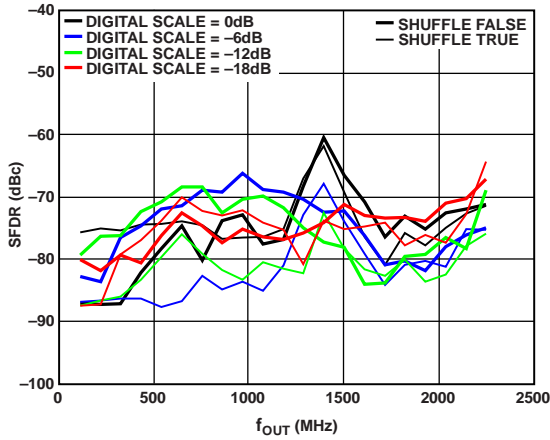

Figure 17. SFDR vs. f_{OUT} over Digital Scale

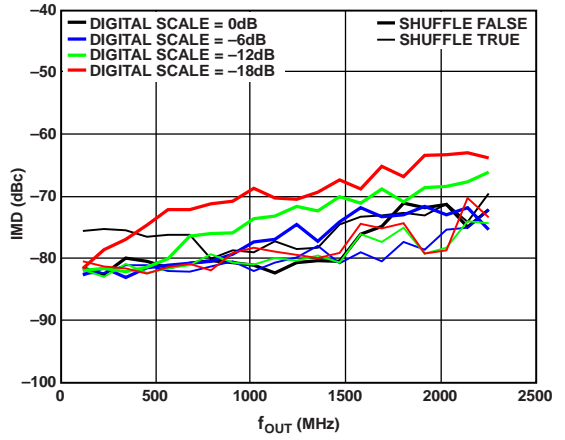

Figure 20. IMD vs. f_{OUT} over Digital Scale

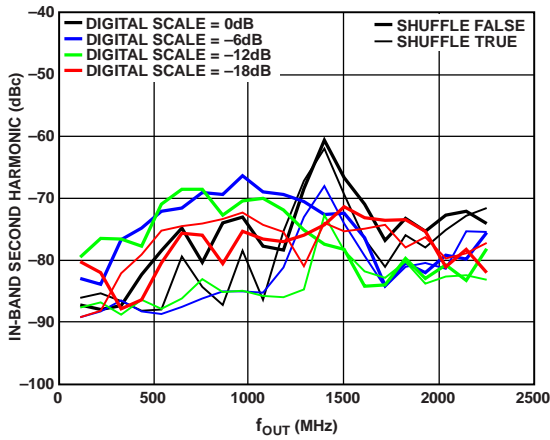

Figure 18. SFDR for In-Band Second Harmonic vs. f_{OUT} over Digital Scale

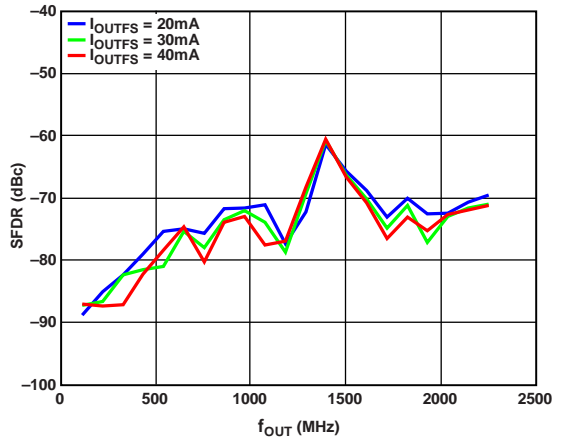

Figure 21. SFDR vs. f_{OUT} over DAC I_{OUTFS}

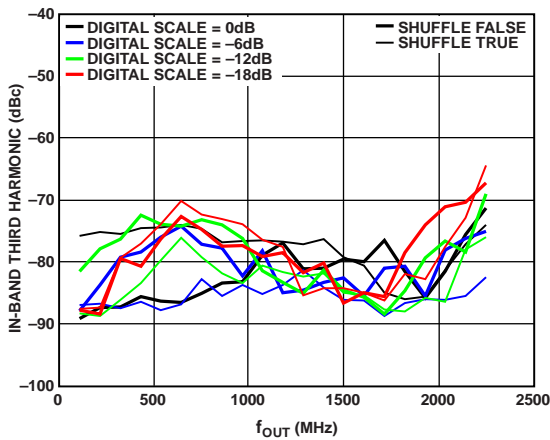

Figure 19. SFDR for In-Band Third Harmonic vs. f_{OUT} over Digital Scale

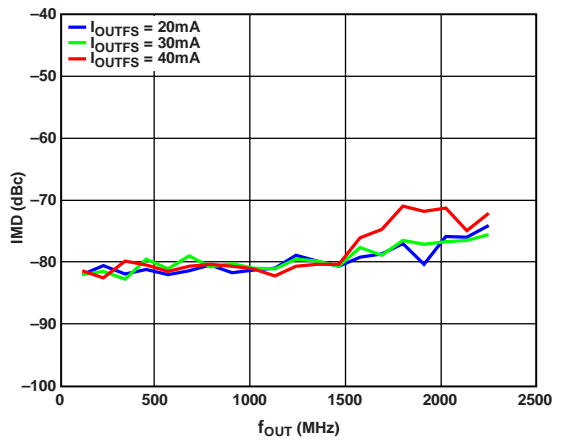

Figure 22. IMD vs. f_{OUT} over DAC I_{OUTFS}

$I_{OUTS} = 40 \text{ mA}$, $f_{DAC} = 5.0 \text{ GSPS}$, nominal supplies, $T_A = 25^\circ\text{C}$, unless otherwise noted.

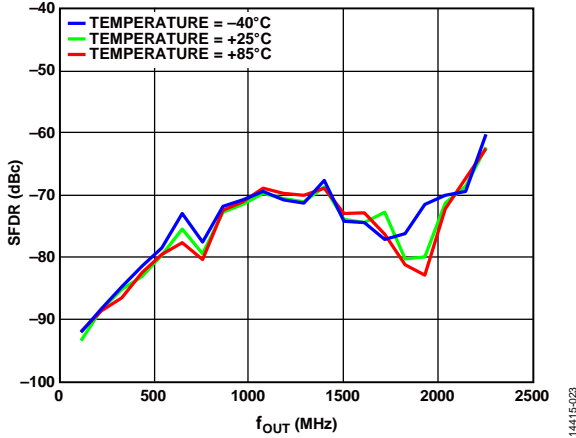

Figure 23. SFDR vs. f_{OUT} over Temperature

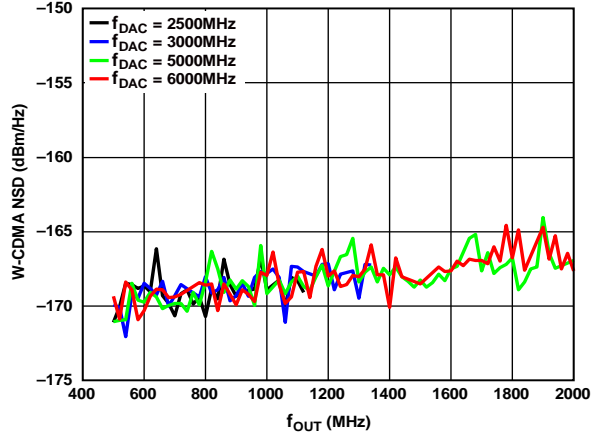

Figure 26. W-CDMA NSD Measured at 70 MHz vs. f_{OUT} over f_{DAC}

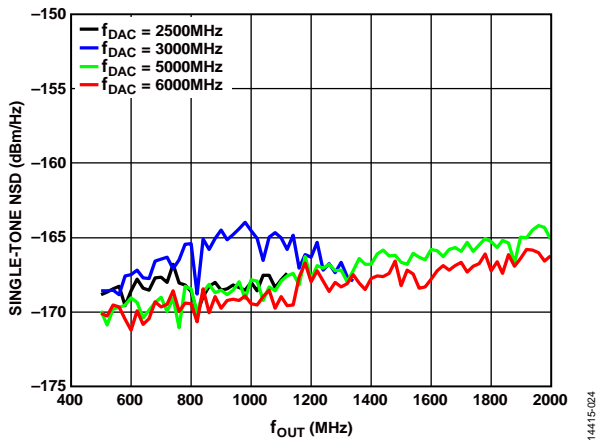

Figure 24. Single-Tone NSD Measured at 70 MHz vs. f_{OUT} over f_{DAC}

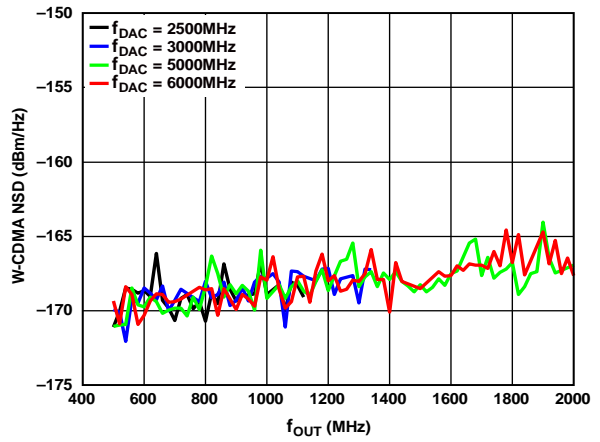

Figure 27. W-CDMA NSD Measured at 10% Offset from f_{OUT} vs. f_{OUT} over f_{DAC}

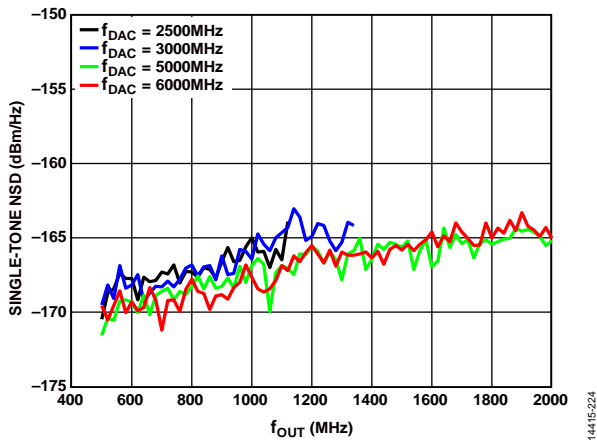

Figure 25. Single-Tone NSD Measured at 10% Offset from f_{OUT} vs. f_{OUT} over f_{DAC}

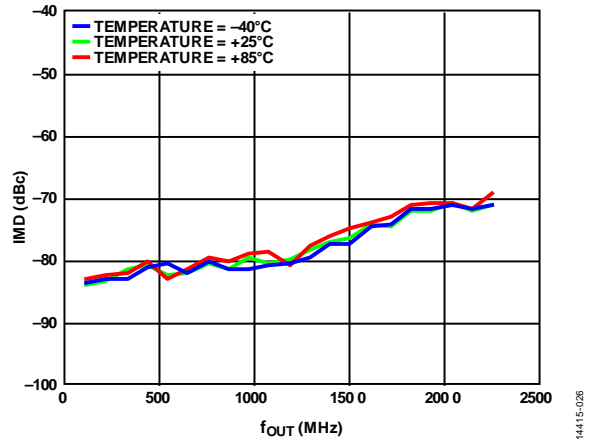

Figure 28. IMD vs. f_{OUT} over Temperature

$I_{OUTFS} = 40 \text{ mA}$, $f_{DAC} = 5.0 \text{ GSPS}$, nominal supplies, $T_A = 25^\circ\text{C}$, unless otherwise noted.

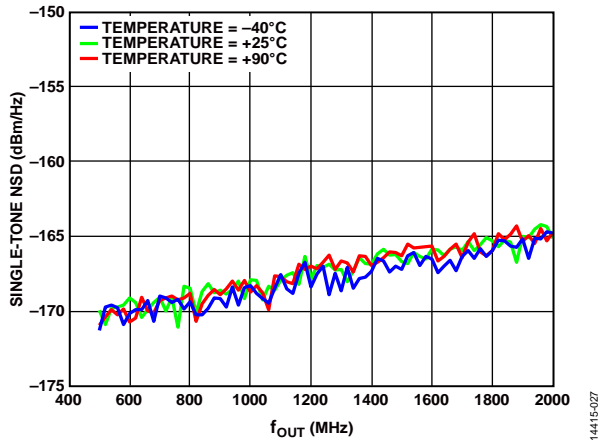

Figure 29. Single-Tone NSD Measured at 70 MHz vs. f_{OUT} over Temperature

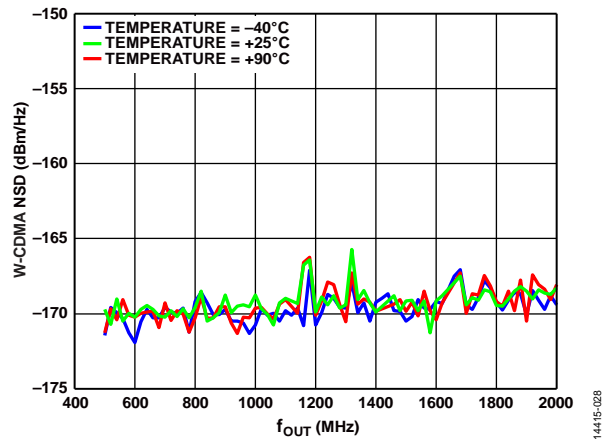

Figure 32. W-CDMA NSD Measured at 70 MHz vs. f_{OUT} over Temperature

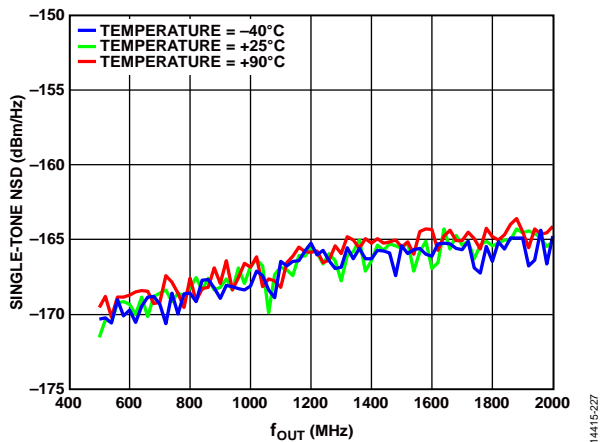

Figure 30. Single-Tone NSD Measured at 10% Offset from f_{OUT} vs. f_{OUT} over Temperature

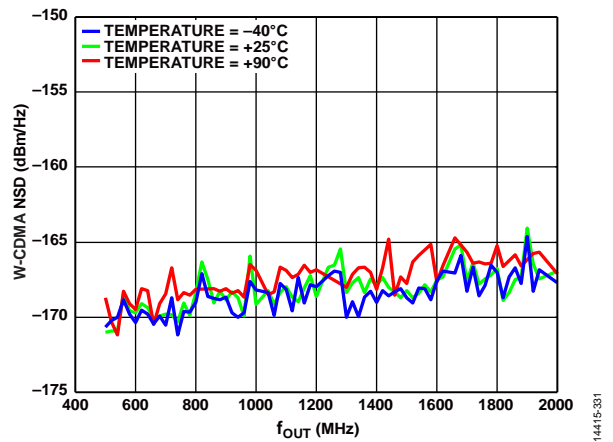

Figure 33. W-CDMA NSD Measured at 10% Offset from f_{OUT} vs. f_{OUT} over Temperature

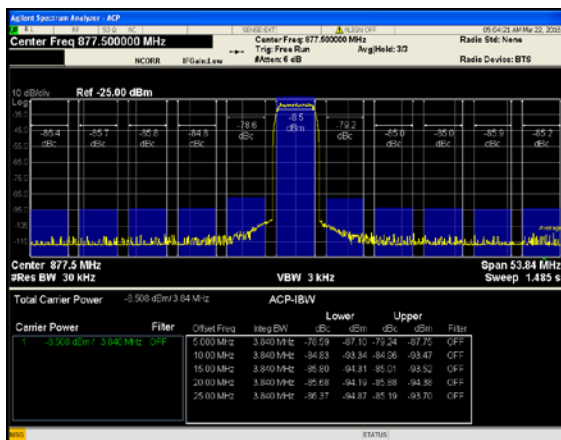

Figure 31. Single-Carrier W-CDMA at 877.5 MHz

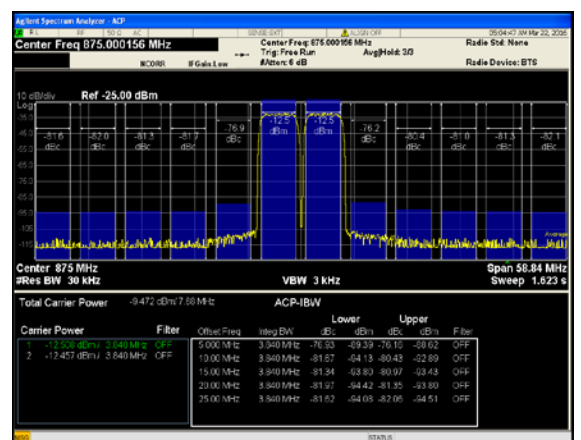

Figure 34. Two-Carrier W-CDMA at 875 MHz

$I_{OUTFS} = 40 \text{ mA}$, $f_{DAC} = 5.0 \text{ GSPS}$, nominal supplies, $T_A = 25^\circ\text{C}$, unless otherwise noted.

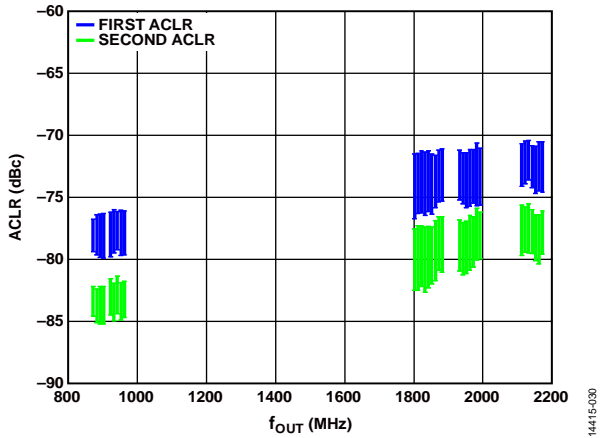

Figure 35. Single-Carrier, W-CDMA Adjacent Channel Leakage Ratio (ACLR) vs. f_{OUT} (First ACLR, Second ACLR)

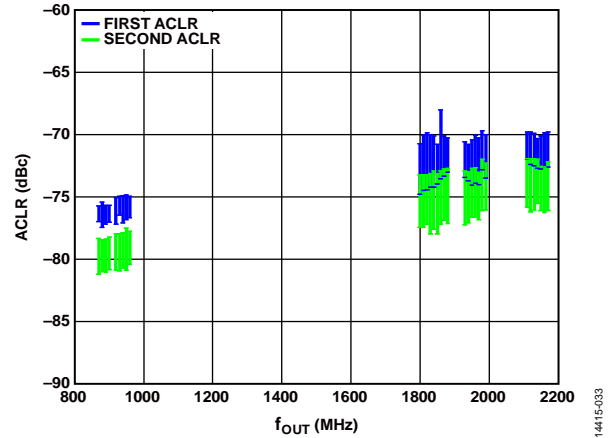

Figure 38. Two-Carrier, W-CDMA ACLR vs. f_{OUT} (First ACLR, Second ACLR)

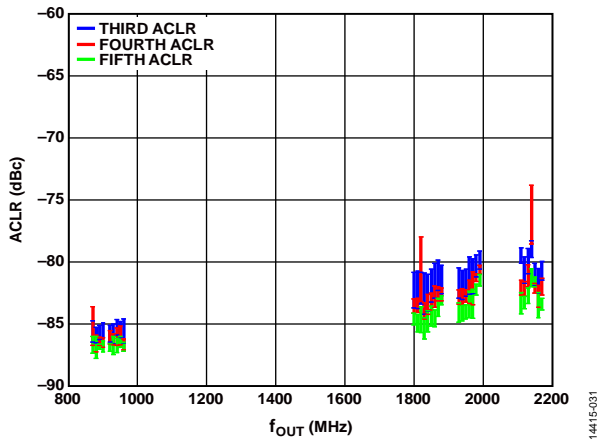

Figure 36. Single-Carrier, W-CDMA ACLR vs. f_{OUT} (Third ACLR, Fourth ACLR, Fifth ACLR)

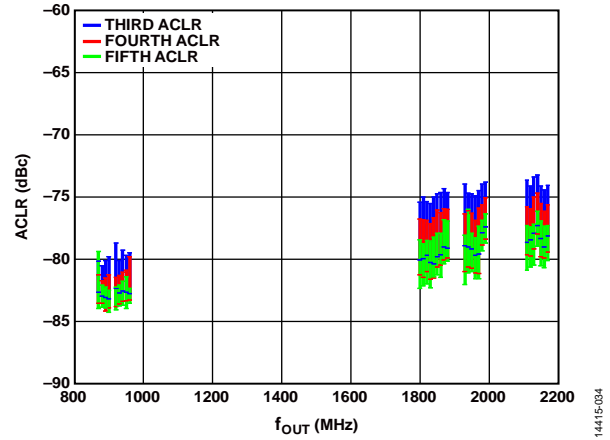

Figure 39. Two-Carrier, W-CDMA ACLR vs. f_{OUT} (Third ACLR, Fourth ACLR, Fifth ACLR)

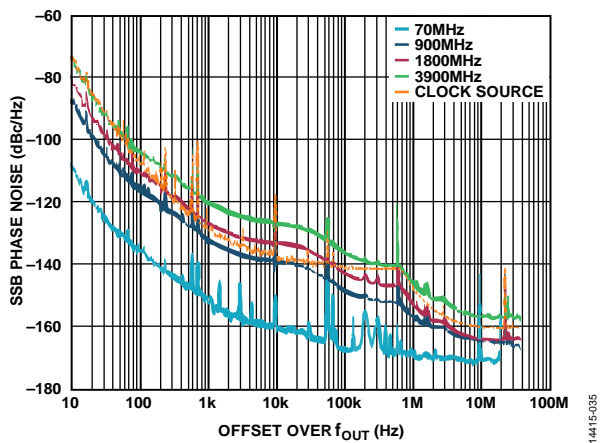

Figure 37. SSB Phase Noise vs. Offset over f_{OUT} , $f_{DAC} = 4000 \text{ MSPS}$ (Two Different DAC Clock Sources Used for Best Composite Curve)

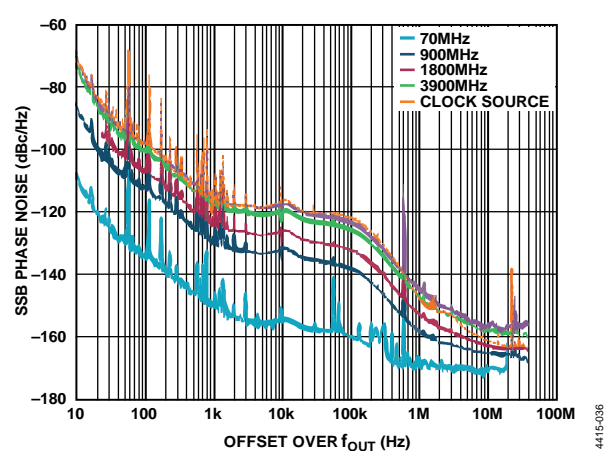

Figure 40. SSB Phase Noise vs. Offset over f_{OUT} , $f_{DAC} = 6000 \text{ MSPS}$

AC (MIX-MODE)

$I_{OUTFS} = 40 \text{ mA}$, $f_{DAC} = 5.0 \text{ GSPS}$, nominal supplies, $T_A = 25^\circ\text{C}$, unless otherwise noted.

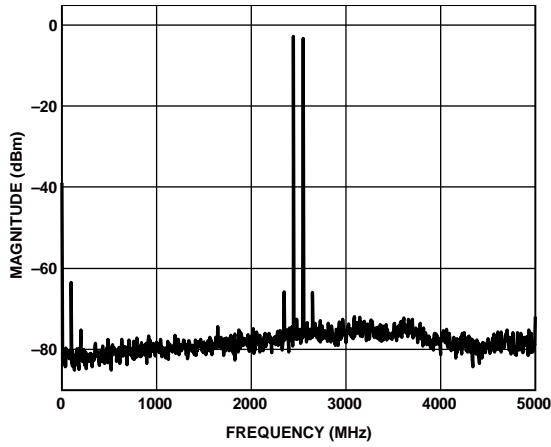

Figure 41. Single-Tone Spectrum at $f_{OUT} = 2350 \text{ MHz}$

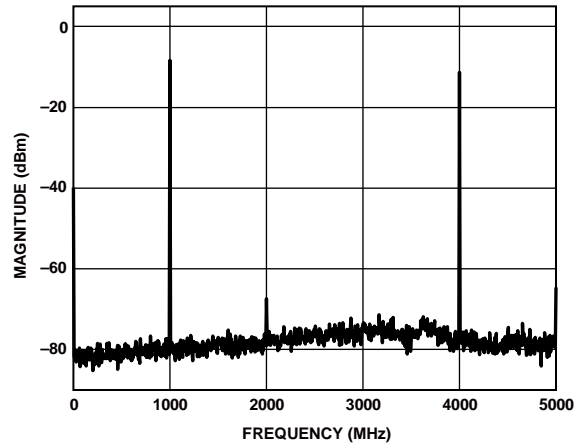

Figure 44. Single-Tone Spectrum at $f_{OUT} = 4000 \text{ MHz}$

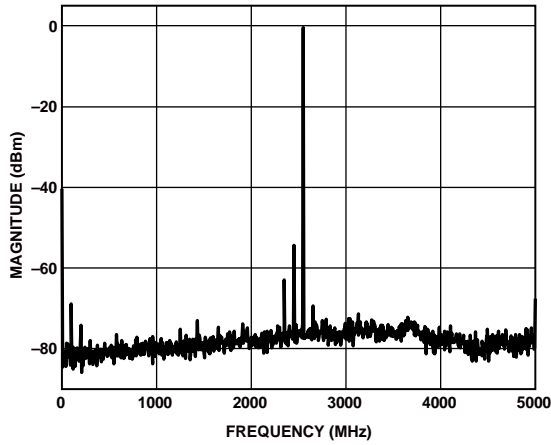

Figure 42. Single-Tone Spectrum at $f_{OUT} = 2350 \text{ MHz}$ (FIR85 Enabled)

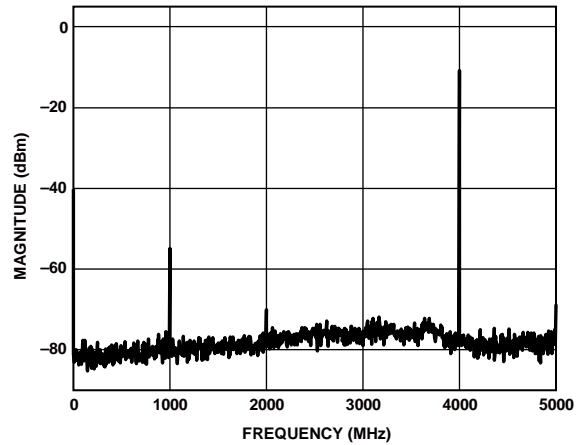

Figure 45. Single-Tone Spectrum at $f_{OUT} = 4000 \text{ MHz}$ (FIR85 Enabled)

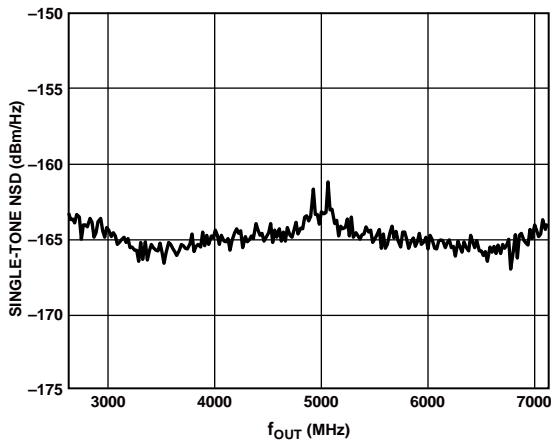

Figure 43. Single-Tone NSD vs. f_{OUT}

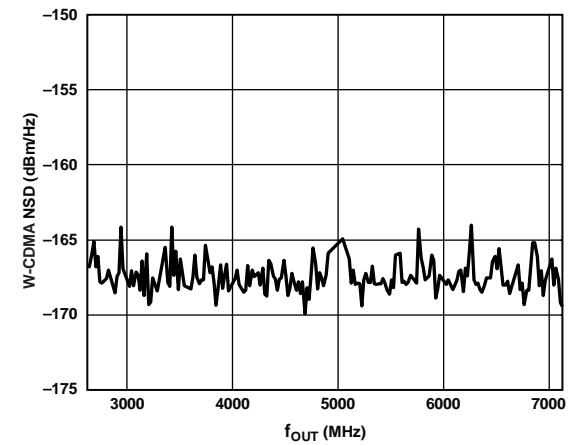

Figure 46. W-CDMA NSD vs. f_{OUT}

$I_{OUTFS} = 40\text{ mA}$, $f_{DAC} = 5.0\text{ GSPS}$, nominal supplies, $T_A = 25^\circ\text{C}$, unless otherwise noted.

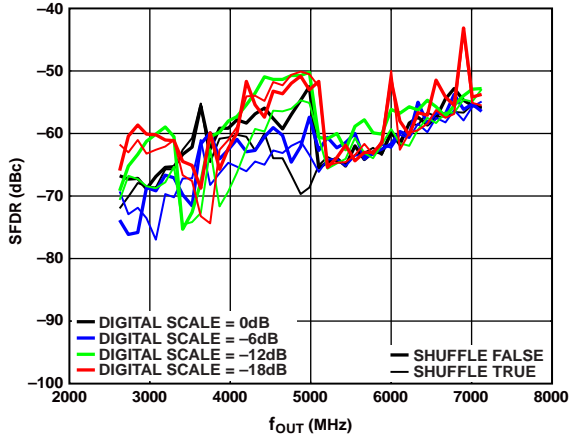

Figure 47. SFDR vs. f_{OUT} over Digital Scale

14415-044

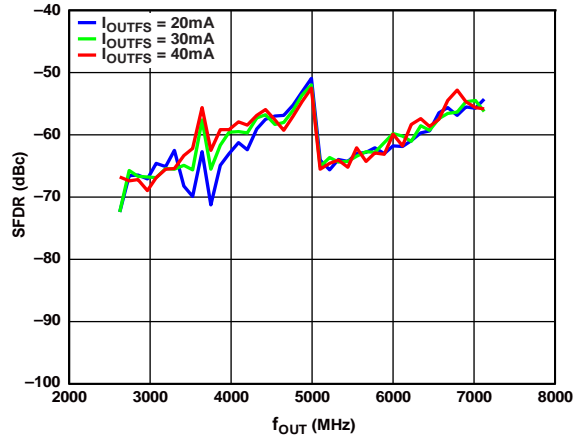

Figure 50. SFDR vs. f_{OUT} over DAC I_{OUTFS}

14415-047

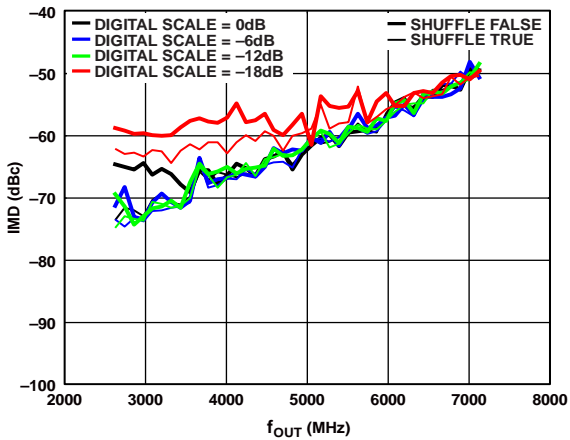

Figure 48. IMD vs. f_{OUT} over Digital Scale

14415-045

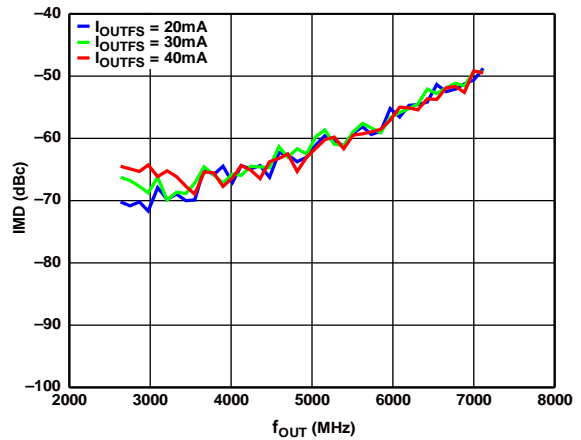

Figure 51. IMD vs. f_{OUT} over DAC I_{OUTFS}

14415-048

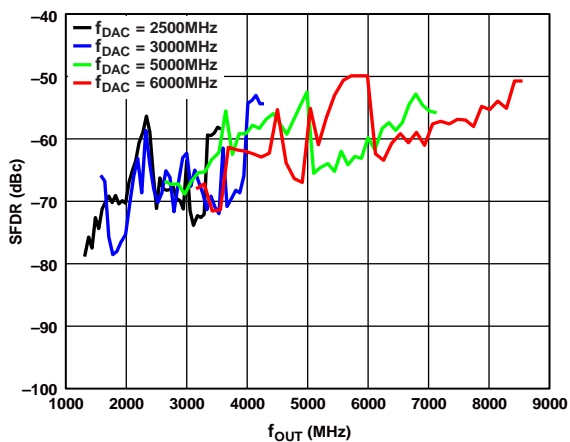

Figure 49. SFDR vs. f_{OUT} over f_{DAC}

14415-046

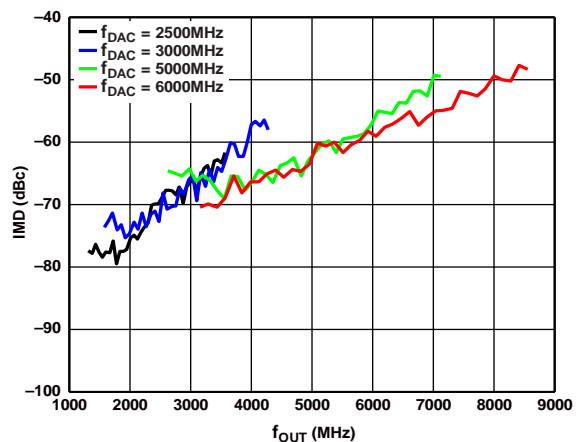

Figure 52. IMD vs. f_{OUT} over f_{DAC}

14415-049

$I_{OUTFS} = 40 \text{ mA}$, $f_{DAC} = 5.0 \text{ GSPS}$, nominal supplies, $T_A = 25^\circ\text{C}$, unless otherwise noted.

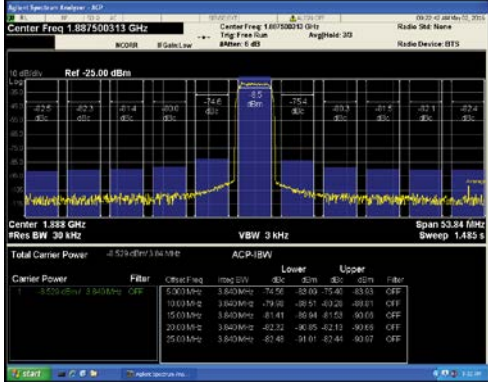

Figure 53. Single-Carrier W-CDMA at 1887.5 MHz

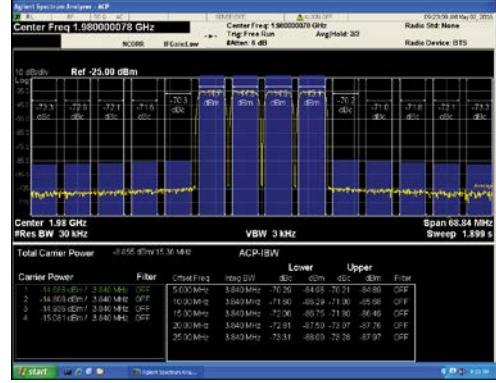

Figure 56. Four-Carrier W-CDMA at 1980 MHz

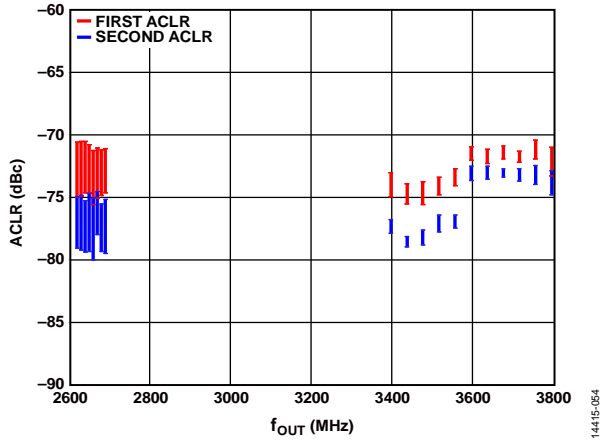

Figure 54. Single-Carrier, W-CDMA ACLR vs. f_{OUT} (First ACLR, Second ACLR)

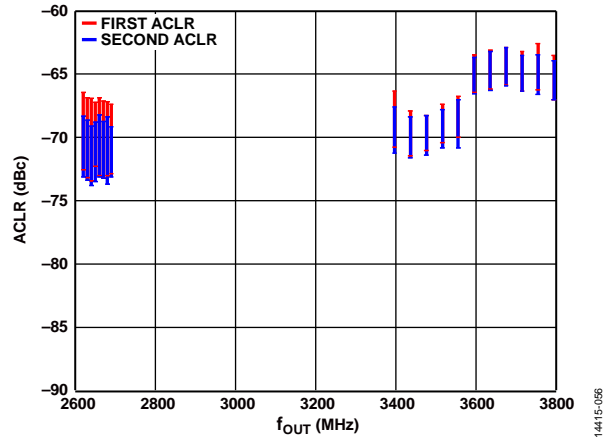

Figure 57. Four-Carrier, W-CDMA ACLR vs. f_{OUT} (First ACLR, Second ACLR)

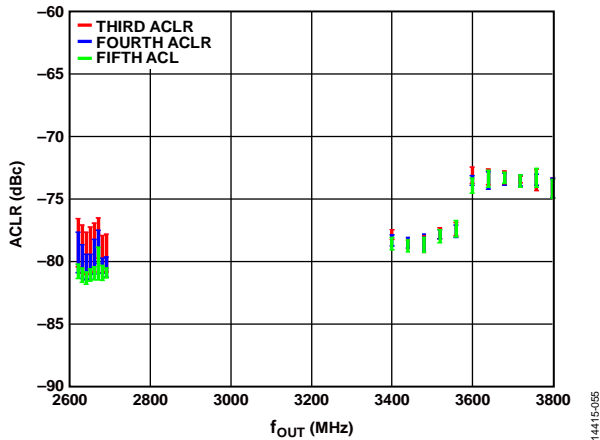

Figure 55. Single-Carrier, W-CDMA ACLR vs. f_{OUT} (Third ACLR, Fourth ACLR, Fifth ACLR)

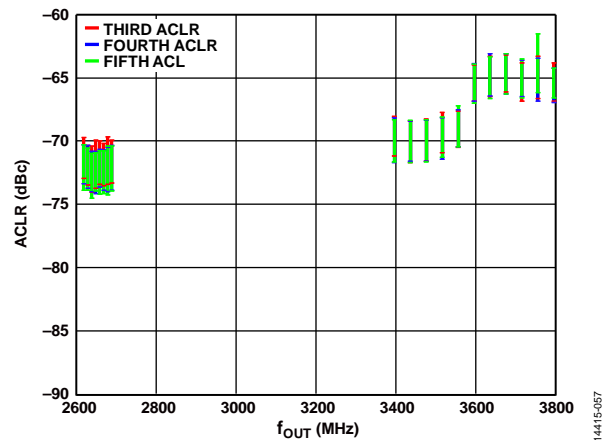

Figure 58. Four-Carrier, W-CDMA ACLR vs. f_{OUT} (Third ACLR, Fourth ACLR, Fifth ACLR)

DOCSIS PERFORMANCE (NRZ MODE)

$I_{OUTFS} = 40 \text{ mA}$, $f_{DAC} = 3.076 \text{ GSPS}$, nominal supplies, FIR85 enabled, $T_A = 25^\circ\text{C}$, unless otherwise noted.

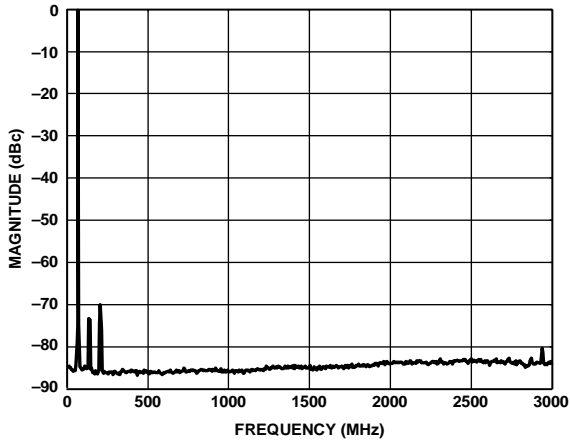

Figure 59. Single Carrier at 70 MHz Output

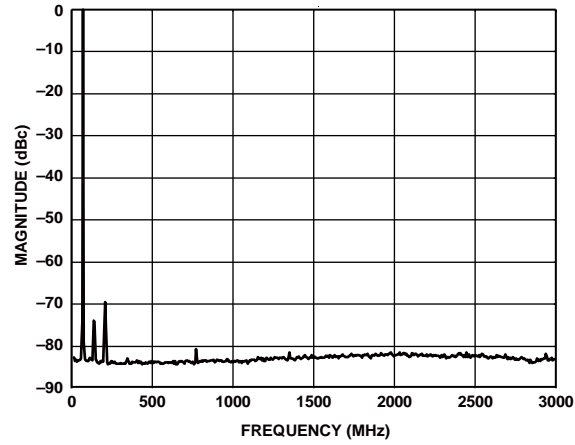

Figure 62. Single Carrier at 70 MHz Output (Shuffle On)

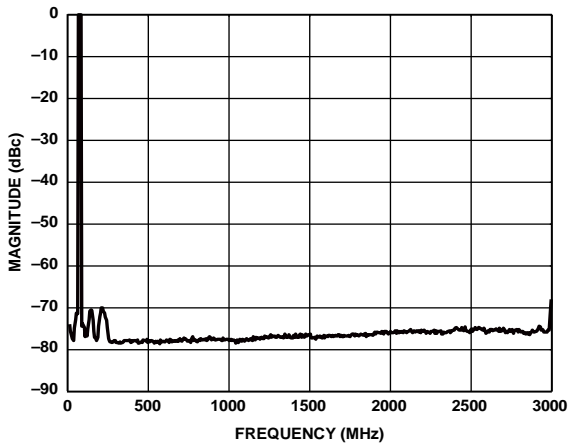

Figure 60. Four Carriers at 70 MHz Output

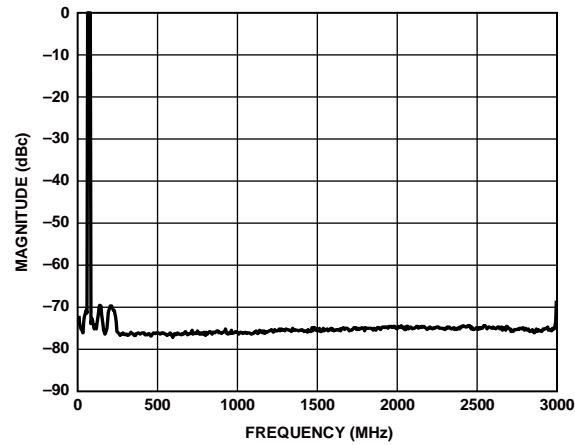

Figure 63. Four Carriers at 70 MHz Output (Shuffle On)

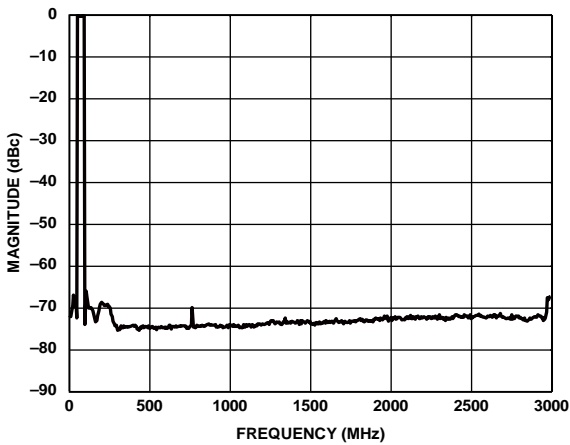

Figure 61. Eight Carriers at 70 MHz Output

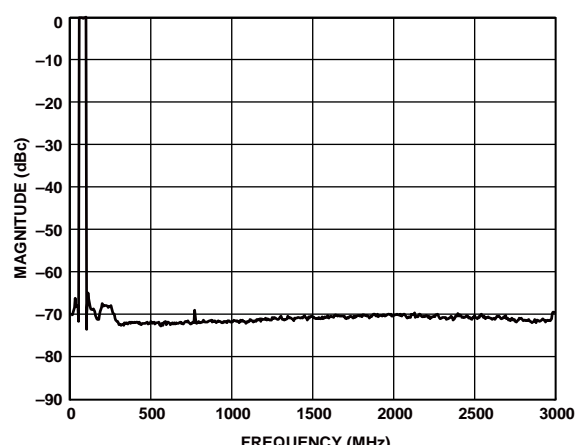

Figure 64. Eight Carriers at 70 MHz Output (Shuffle On)

$I_{OUTFS} = 40 \text{ mA}$, $f_{DAC} = 3.076 \text{ GSPS}$, nominal supplies, FIR85 enabled, $T_A = 25^\circ\text{C}$, unless otherwise noted.

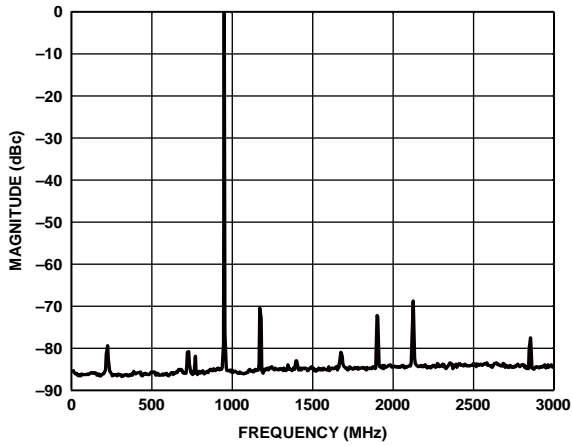

Figure 65. Single Carrier at 950 MHz Output

14415-061

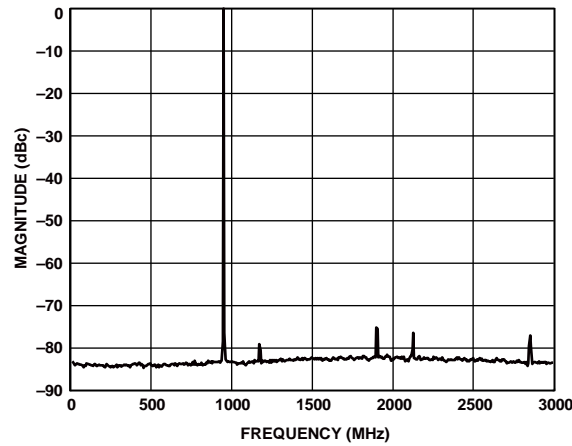

Figure 68. Single Carrier at 950 MHz Output (Shuffle On)

14415-364

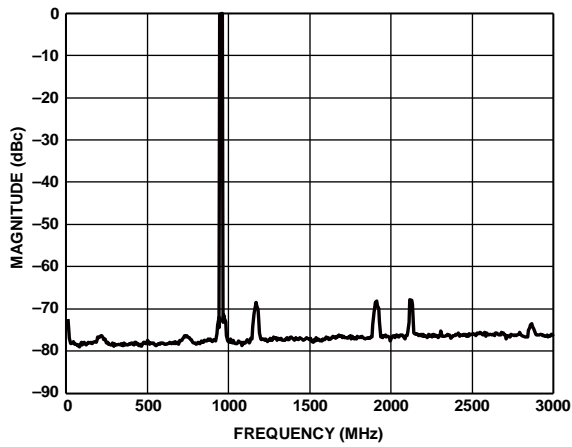

Figure 66. Four Carriers at 950 MHz Output

14415-062

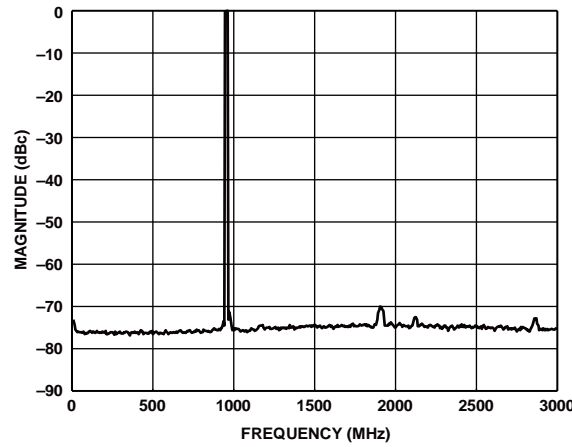

Figure 69. Four Carriers at 950 MHz Output (Shuffle On)

14415-365

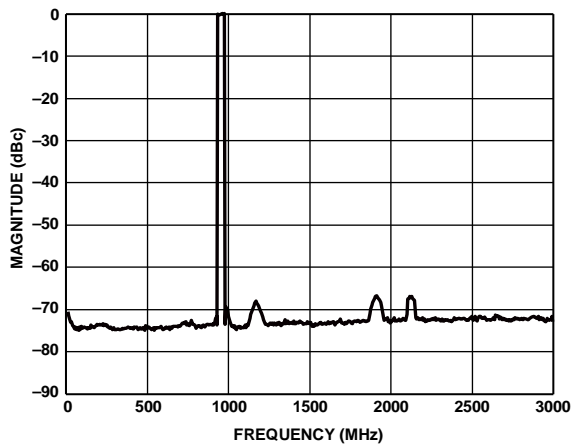

Figure 67. Eight Carriers at 950 MHz Output

14415-063

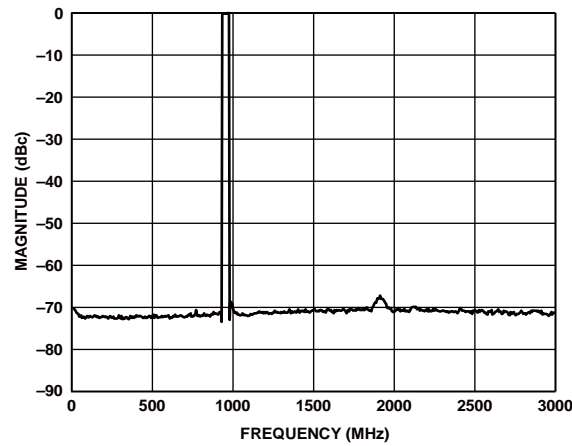

Figure 70. Eight Carriers at 950 MHz Output (Shuffle On)

14415-366

$I_{OUTFS} = 40 \text{ mA}$, $f_{DAC} = 3.076 \text{ GSPS}$, nominal supplies, FIR85 enabled, $T_A = 25^\circ\text{C}$, unless otherwise noted.

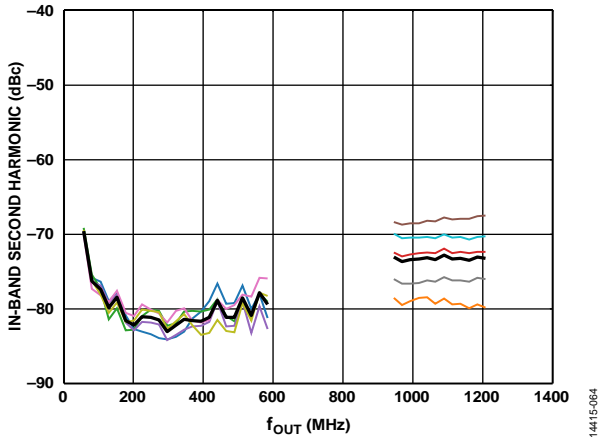

Figure 71. In-Band Second Harmonic vs. f_{OUT} Performance for One DOCSIS Carrier

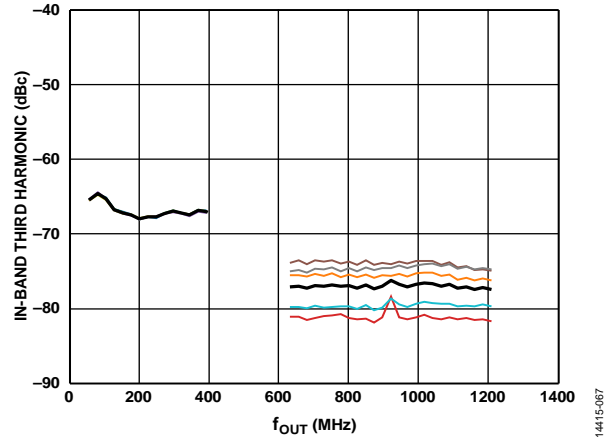

Figure 74. In-Band Third Harmonic vs. f_{OUT} Performance for One DOCSIS Carrier

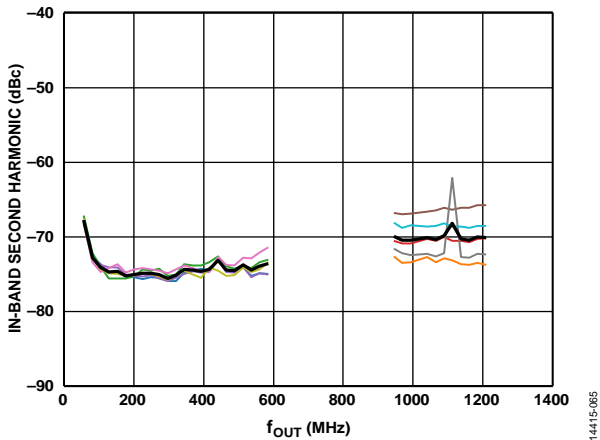

Figure 72. In-Band Second Harmonic vs. f_{OUT} Performance for Four DOCSIS Carriers

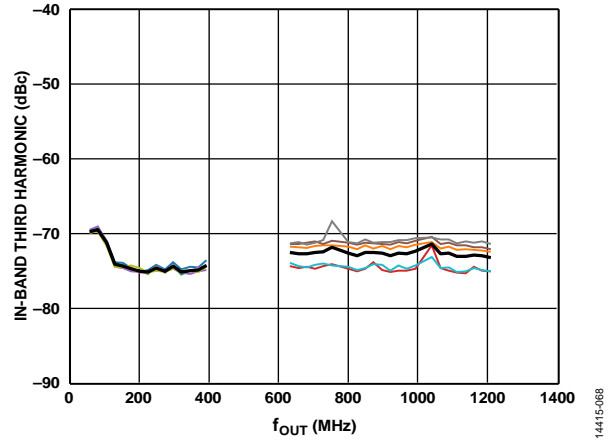

Figure 75. In-Band Third Harmonic vs. f_{OUT} Performance for Four DOCSIS Carriers

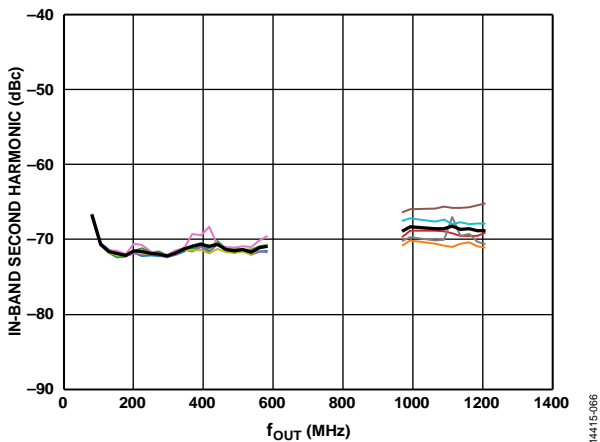

Figure 73. In-Band Second Harmonic vs. f_{OUT} Performance for Eight DOCSIS Carriers

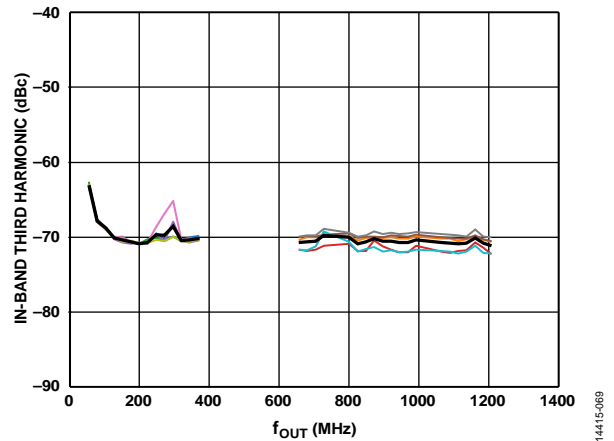

Figure 76. In-Band Third Harmonic vs. f_{OUT} Performance for Eight DOCSIS Carriers

$I_{OUTFS} = 40 \text{ mA}$, $f_{DAC} = 3.076 \text{ GSPS}$, nominal supplies, FIR85 enabled, $T_A = 25^\circ\text{C}$, unless otherwise noted.

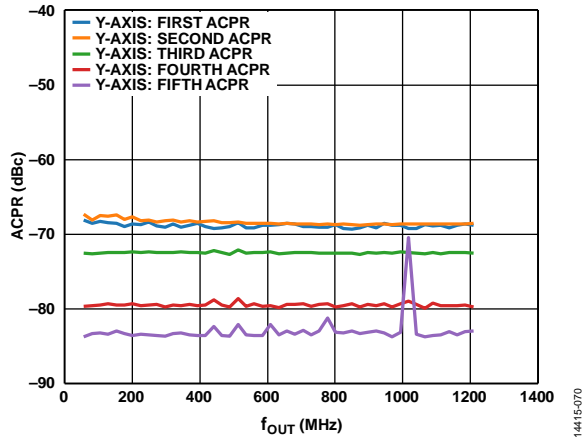

Figure 77. Single-Carrier Adjacent Channel Power Ratio (ACPR) vs. f_{OUT}

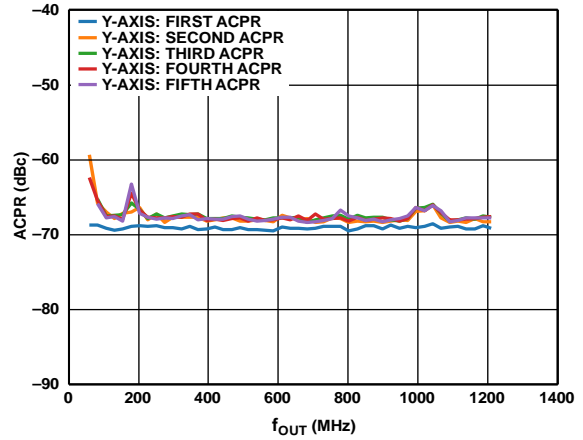

Figure 80. 16-Carrier ACPR vs. f_{OUT}

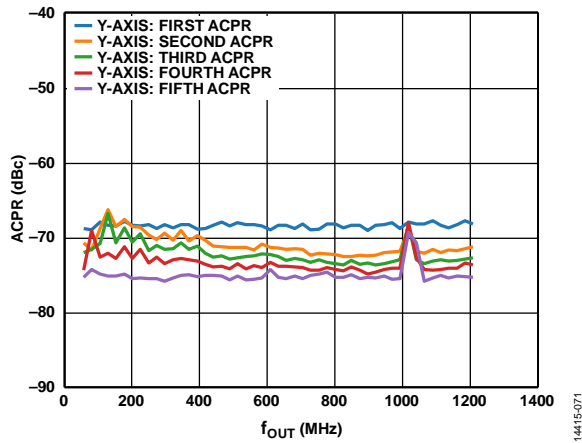

Figure 78. Four-Carrier ACPR vs. f_{OUT}

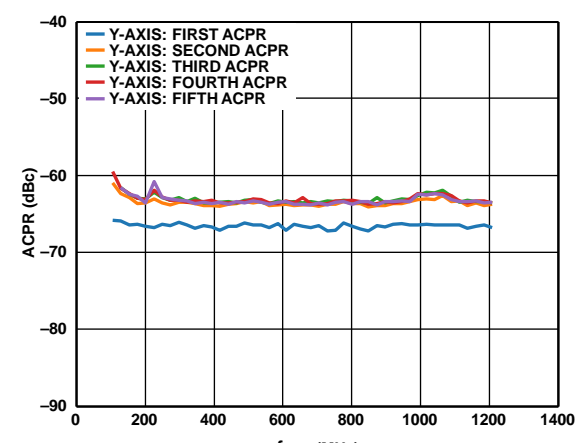

Figure 81. 32-Carrier ACPR vs. f_{OUT}

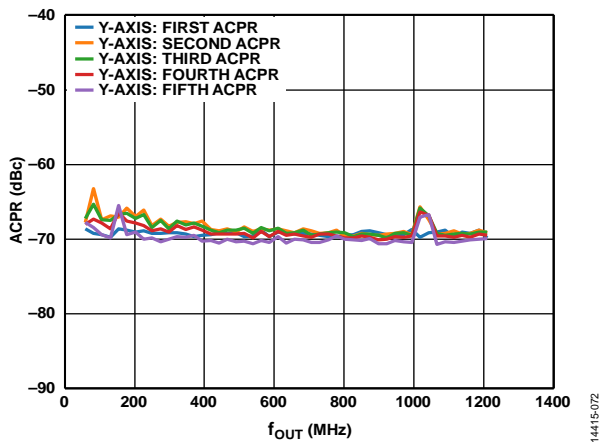

Figure 79. Eight-Carrier ACPR vs. f_{OUT}

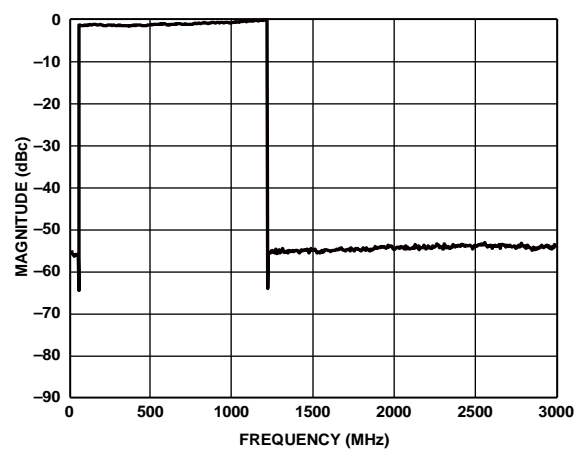

Figure 82. 194-Carrier, Sinc Enabled, FIR85 Enabled

$I_{OUTFS} = 40 \text{ mA}$, $f_{DAC} = 3.076 \text{ GSPS}$, nominal supplies, FIR85 enabled, $T_A = 25^\circ\text{C}$, unless otherwise noted.

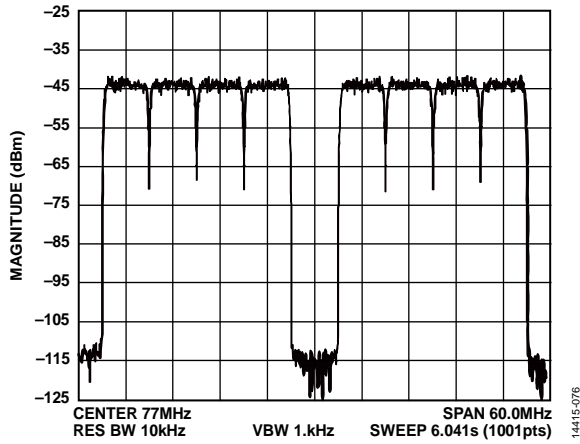

Figure 83. Gap Channel ACLR at 77 MHz

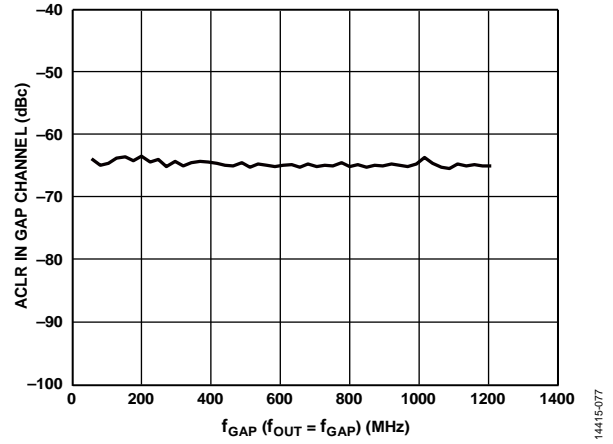

Figure 84. ACLR in Gap Channel vs. f_{GAP}

TERMINOLOGY

Integral Nonlinearity (INL)

INL is the maximum deviation of the actual analog output from the ideal output, determined by a straight line drawn from zero scale to full scale.

Differential Nonlinearity (DNL)

DNL is the measure of the variation in analog value, normalized to full scale, associated with a 1 LSB change in digital input code.

Offset Error

Offset error is the deviation of the output current from the ideal of 0 mA. For OUTPUT+, 0 mA output is expected when all inputs are set to 0. For OUTPUT-, 0 mA output is expected when all inputs are set to 1.

Gain Error

Gain error is the difference between the actual and ideal output span. The actual span is determined by the difference between the output when the input is at its minimum code and the output when the input is at its maximum code.

Temperature Drift

Temperature drift is specified as the maximum change from the ambient (25°C) value to the value at either T_{MIN} or T_{MAX} . For offset and gain drift, the drift is reported in ppm of full-scale range (FSR) per degree Celsius. For reference drift, the drift is reported in ppm per degree Celsius.

Settling Time

Settling time is the time required for the output to reach and remain within a specified error band around its final value, measured from the start of the output transition.

Spurious-Free Dynamic Range (SFDR)

SFDR is the difference, in decibels, between the peak amplitude of the output signal and the peak spurious signal within the dc to Nyquist frequency of the DAC. Typically, energy in this band is rejected by the interpolation filters. This specification,

therefore, defines how well the interpolation filters work and the effect of other parasitic coupling paths on the DAC output.

Signal-to-Noise Ratio (SNR)

SNR is the ratio of the rms value of the measured output signal to the rms sum of all other spectral components below the Nyquist frequency, excluding the first six harmonics and dc. The value for SNR is expressed in decibels.

Interpolation Filter

If the digital inputs to the DAC are sampled at a multiple rate of the interpolation rate (f_{DATA}), a digital filter can be constructed that has a sharp transition band near $f_{DATA}/2$. Images that typically appear around the output data rate (f_{DAC}) can be greatly suppressed.

Adjacent Channel Leakage Ratio (ACLR)

ACLR is the ratio in decibels relative to the carrier (dBc) between the measured power within a channel relative to its adjacent channel.

Adjusted DAC Update Rate

The adjusted DAC update rate is the DAC update rate divided by the smallest interpolating factor. For clarity on DACs with multiple interpolating factors, the adjusted DAC update rate for each interpolating factor may be given.

Physical Lane

Physical Lane x refers to $SERDIN_{x\pm}$.

Logical Lane

Logical Lane x refers to physical lanes after optionally being remapped by the crossbar block (Register 0x308 to Register 0x30B).

Link Lane

Link Lane x refers to logical lanes considered in the link.

THEORY OF OPERATION

The **AD9163** is a 16-bit single RF DAC and digital upconverter with a SERDES interface. Figure 1 shows a detailed functional block diagram of the **AD9163**. Eight high speed serial lanes carry data at a maximum speed of 12.5 Gbps, and either a 5 GSPS real input or a 2.5 GSPS complex input data rate to the DAC. Compared to either LVDS or CMOS interfaces, the SERDES interface simplifies pin count, board layout, and input clock requirements to the device.

The clock for the input data is derived from the DAC clock, or device clock (required by the JESD204B specification). This device clock is sourced with a high fidelity direct external DAC sampling clock. The performance of the DAC can be optimized by using on-chip adjustments to the clock input, accessible through the SPI port. The device can be configured to operate in one-lane, two-lane, three-lane, four-lane, six-lane, or eight-lane modes, depending on the required input data rate.

The digital datapath of the **AD9163** offers several interpolation modes (6×, 8×, 12×, 16×, and 24×) through either an initial half-band (2×) or third-band (3×) filter with programmable 80% or 90% bandwidth, and three subsequent half-band filters (all 90%) with a maximum DAC sample rate of 6 GSPS. An inverse sinc filter is provided to compensate for sinc related roll-off. An additional half-band filter, FIR85, takes advantage of the quad-switch architecture to interpolate on the falling edge of the clock, and effectively double the DAC update rate in 2× NRZ mode. A 48-bit programmable modulus NCO is provided to enable digital frequency shifts of signals with near infinite precision. The NCO can be operated with digital data from the SERDES interface and digital datapath. The 100 MHz speed of the SPI write interface enables rapid updating of the frequency tuning word of the NCO.

The **AD9163** DAC core provides a fully differential current output with a nominal full-scale current of 38.76 mA. The full-scale output current, I_{OUTFS} , is user adjustable from 8 mA to 38.76 mA, typically. The differential current outputs are complementary. The DAC uses the patented quad-switch architecture, which enables DAC decoder options to extend the output frequency range into the second and third Nyquist zones with Mix-Mode, return to zero (RZ) mode, and 2× NRZ mode (with FIR85 enabled). Mix-Mode can be used to access 1.5 GHz to around 7.5 GHz. In the interpolation modes, the output can range from 0 Hz to 6 GHz in 2× NRZ mode using the NCO to shift a signal of up to 1.8 GHz instantaneous bandwidth to the desired f_{OUT} .

The **AD9163** is capable of multichip synchronization that can both synchronize multiple DACs and establish a constant and deterministic latency (latency locking) path for the DACs. The latency for each of the DACs remains constant to within several DAC clock cycles from link establishment to link establishment. An external alignment (SYSREF±) signal makes the **AD9163** Subclass 1 compliant. Several modes of SYSREF± signal handling are available for use in the system.

An SPI configures the various functional blocks and monitors their statuses. The various functional blocks and the data interface must be set up in a specific sequence for proper operation (see the Start-Up Sequence section). Simple SPI initialization routines set up the JESD204B link and are included in the evaluation board package. This data sheet describes the various blocks of the **AD9163** in greater detail. Descriptions of the JESD204B interface, control parameters, and various registers to set up and monitor the device are provided. The recommended start-up routine reliably sets up the data link.

SERIAL PORT OPERATION

The serial port is a flexible, synchronous serial communications port that allows easy interfacing with many industry-standard microcontrollers and microprocessors. The serial input/output (I/O) is compatible with most synchronous transfer formats, including both the Motorola SPI and Intel® SSR protocols. The interface allows read/write access to all registers that configure the AD9163. MSB first or LSB first transfer formats are supported. The serial port interface can be configured as a 4-wire interface or a 3-wire interface in which the input and output share a single-pin I/O (SDIO).

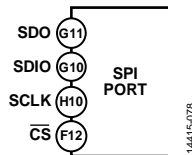

Figure 85. Serial Port Interface Pins

There are two phases to a communication cycle with the AD9163. Phase 1 is the instruction cycle (the writing of an instruction byte into the device), coincident with the first 16 SCLK rising edges. The instruction word provides the serial port controller with information regarding the data transfer cycle, Phase 2 of the communication cycle. The Phase 1 instruction word defines whether the upcoming data transfer is a read or write, along with the starting register address for the following data transfer.

A logic high on the \overline{CS} pin followed by a logic low resets the serial port timing to the initial state of the instruction cycle. From this state, the next 16 rising SCLK edges represent the instruction bits of the current I/O operation.

The remaining SCLK edges are for Phase 2 of the communication cycle. Phase 2 is the actual data transfer between the device and the system controller. Phase 2 of the communication cycle is a transfer of one or more data bytes. Eight \times N SCLK cycles are needed to transfer N bytes during the transfer cycle. Registers change immediately upon writing to the last bit of each transfer byte, except for the frequency tuning word (FTW) and numerically controlled oscillator (NCO) phase offsets, which change only when the frequency tuning word FTW_LOAD_REQ bit is set.

DATA FORMAT

The instruction byte contains the information shown in Table 13.

Table 13. Serial Port Instruction Word

I15 (MSB)	I[14:0]
R/ \overline{W}	A[14:0]

$\overline{R/\overline{W}}$, Bit 15 of the instruction word, determines whether a read or a write data transfer occurs after the instruction word write. Logic 1 indicates a read operation, and Logic 0 indicates a write operation.

A14 to A0, Bit I14 to Bit I0 of the instruction word, determine the register that is accessed during the data transfer portion of the communication cycle. For multibyte transfers, A[14:0] is the starting address. The remaining register addresses are generated by the device based on the address increment bit. If the address increment bits are set high (Register 0x000, Bit 5 and Bit 2), multibyte SPI writes start on A[14:0] and increment by 1 every eight bits sent/received. If the address increment bits are set to 0, the address decrements by 1 every eight bits.

SERIAL PORT PIN DESCRIPTIONS

Serial Clock (SCLK)

The serial clock pin synchronizes data to and from the device and runs the internal state machines. The maximum frequency of SCLK is 100 MHz. All data input is registered on the rising edge of SCLK. All data is driven out on the falling edge of SCLK.

Chip Select (\overline{CS})

An active low input starts and gates a communication cycle. \overline{CS} allows more than one device to be used on the same serial communications lines. The SDIO pin goes to a high impedance state when this input is high. During the communication cycle, the chip select must stay low.

Serial Data I/O (SDIO)

This pin is a bidirectional data line. In 4-wire mode, this pin acts as the data input and SDO acts as the data output.

SERIAL PORT OPTIONS

The serial port can support both MSB first and LSB first data formats. This functionality is controlled by the LSB first bit (Register 0x000, Bit 6 and Bit 1). The default is MSB first (LSB bit = 0).

When the LSB first bits = 0 (MSB first), the instruction and data bits must be written from MSB to LSB. $\overline{R/\overline{W}}$ is followed by A[14:0] as the instruction word, and D[7:0] is the data-word. When the LSB first bits = 1 (LSB first), the opposite is true. A[0:14] is followed by $\overline{R/\overline{W}}$, which is subsequently followed by D[0:7].

The serial port supports a 3-wire or 4-wire interface. When the SDO active bits = 1 (Register 0x000, Bit 4 and Bit 3), a 4-wire interface with a separate input pin (SDIO) and output pin (SDO) is used. When the SDO active bits = 0, the SDO pin is unused and the SDIO pin is used for both the input and the output.

Multibyte data transfers can be performed as well by holding the \overline{CS} pin low for multiple data transfer cycles (eight SCLKs) after the first data transfer word following the instruction cycle. The first eight SCLKs following the instruction cycle read from or write to the register provided in the instruction cycle. For each additional eight SCLK cycles, the address is either incremented or decremented and the read/write occurs on the new register.

The direction of the address can be set using ADDRINC or ADDRINC_M (Register 0x000, Bit 5 and Bit 2). When ADDRINC or ADDRINC_M is 1, the multicycle addresses are incremented. When ADDRINC or ADDRINC_M is 0, the addresses are decremented. A new write cycle can always be initiated by bringing CS high and then low again.

To prevent confusion and to ensure consistency between devices, the chip tests the first nibble following the address phase, ignoring the second nibble. This test is completed independently from the LSB first bits and ensures that there are extra clock cycles following the soft reset bits (Register 0x000, Bit 0 and Bit 7). This test of the first nibble only applies when writing to Register 0x000.

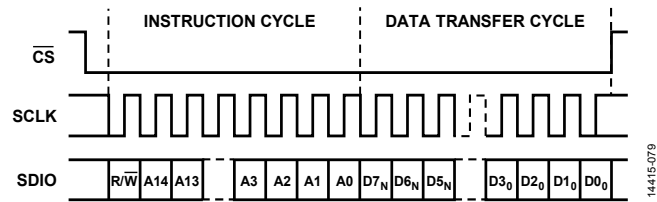

Figure 86. Serial Register Interface Timing, MSB First, Register 0x000, Bit 5 and Bit 2 = 0

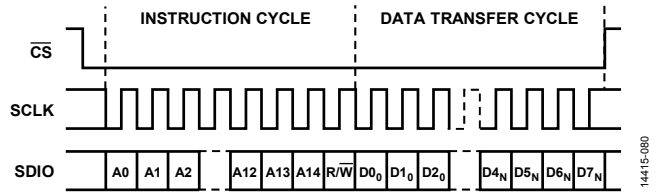

Figure 87. Serial Register Interface Timing, LSB First, Register 0x000, Bit 5 and Bit 2 = 1

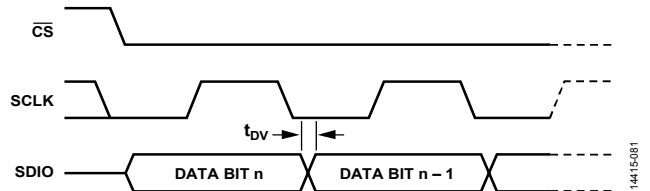

Figure 88. Timing Diagram for Serial Port Register Read

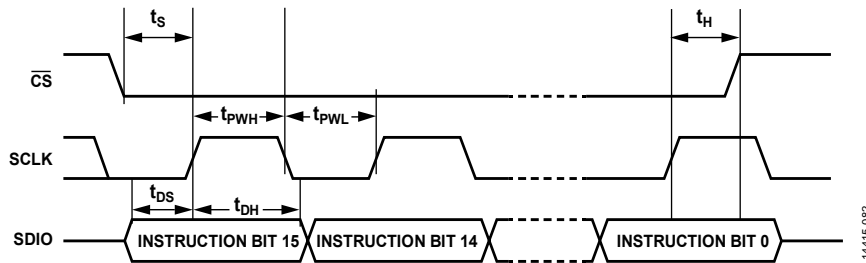

Figure 89. Timing Diagram for Serial Port Register Write

JESD204B SERIAL DATA INTERFACE

JESD204B OVERVIEW

The AD9163 has eight JESD204B data ports that receive data. The eight JESD204B ports can be configured as part of a single JESD204B link that uses a single system reference (SYSREF±) and device clock (CLK±).

The JESD204B serial interface hardware consists of three layers: the physical layer, the data link layer, and the transport layer. These sections of the hardware are described in subsequent sections, including information for configuring every aspect of the interface. Figure 90 shows the communication layers implemented in the AD9163 serial data interface to recover the clock and deserialize, descramble, and deframe the data before it is sent to the digital signal processing section of the device.

The physical layer establishes a reliable channel between the transmitter (Tx) and the receiver (Rx), the data link layer is responsible for unpacking the data into octets and descrambling the data. The transport layer receives the descrambled JESD204B frames and converts them to DAC samples.

A number of JESD204B parameters (L, F, K, M, N, NP, S, HD) define how the data is packed and tell the device how to turn the serial data into samples. These parameters are defined in detail in the Transport Layer section. The AD9163 also has a descrambling option (see the Descrambler section for more information).

The various combinations of JESD204B parameters that are supported depend solely on the number of lanes. Thus, a unique set of parameters can be determined by selecting the lane count to be used. In addition, the interpolation rate and number of lanes can be used to define the rest of the configuration needed to set up the AD9163. The interpolation rate and the number of lanes are selected in Register 0x110.

The AD9163 has a single DAC output; however, for the purposes of the complex signal processing on chip, the converter count is defined as $M = 2$ whenever interpolation is used.

For a particular application, the number of converters to use (M) and the DataRate variable are known. The LaneRate variable and number of lanes (L) can be traded off as follows:

$$DataRate = (DACRate)/(InterpolationFactor)$$

$$LaneRate = (20 \times DataRate \times M)/L$$

where LaneRate must be between 750 Mbps and 12.5 Gbps.

Achieving and recovering synchronization of the lanes is very important. To simplify the interface to the transmitter, the AD9163 designate a master synchronization signal for each JESD204B link. The SYNCOUT± pin is used as the master signal for all lanes. If any lane in a link loses synchronization, a resynchronization request is sent to the transmitter via the synchronization signal of the link. The transmitter stops sending data and instead sends synchronization characters to all lanes in that link until resynchronization is achieved.

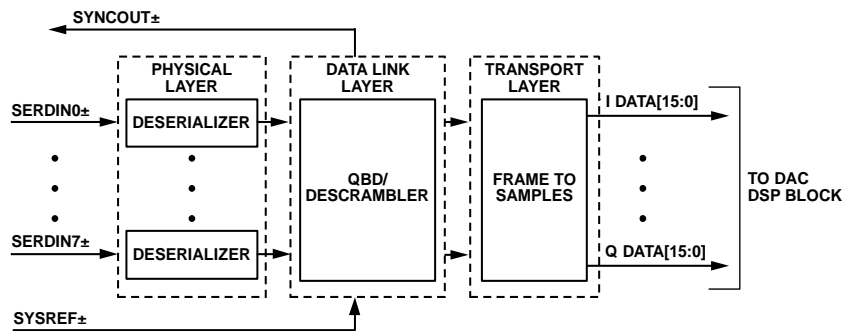

Figure 90. Functional Block Diagram of Serial Link Receiver

Table 14. Single-Link JESD204B Operating Modes

Parameter	Number of Lanes (L)					
	1	2	3	4	6	8
L (Lane Count)	1	2	3	4	6	8
M (Converter Count)	2	2	2	2	2	2
F (Octets per Frame per Lane)	4	2	4	1	2	1
S (Samples per Converter per Frame)	1	1	3	1	3	2

Table 15. Data Structure per Lane for JESD204B Operating Modes¹

JESD204B Parameters	Lane No.	Frame 0	Frame 1	Frame 2	Frame 3
L = 8, M = 2, F = 1, S = 2	Lane 0 Lane 1 Lane 2 Lane 3 Lane 4 Lane 5 Lane 6 Lane 7	MOS0[15:8] MOS0[7:0] MOS1[15:8] MOS1[7:0] M1S0[15:8] M1S0[7:0] M1S1[15:8] M1S1[7:0]			
L = 6, M = 2, F = 2, S = 3	Lane 0 Lane 1 Lane 2 Lane 3 Lane 4 Lane 5	MOS0[15:8] MOS1[15:8] MOS2[15:8] M1S0[15:8] M1S1[15:8] M1S2[15:8]	MOS0[7:0] MOS1[7:0] MOS2[7:0] M1S0[7:0] M1S1[7:0] M1S2[7:0]		
L = 4, M = 2, F = 1, S = 1	Lane 0 Lane 1 Lane 2 Lane 3	MOS0[15:8] MOS0[7:0] M1S0[15:8] M1S0[7:0]			
L = 3, M = 2, F = 4, S = 3	Lane 0 Lane 1 Lane 2	MOS0[15:8] MOS2[15:8] M1S1[15:8]	MOS0[7:0] MOS2[7:0] M1S1[7:0]	MOS1[15:8] M1S0[15:8] M1S2[15:8]	MOS1[7:0] M1S0[7:0] M1S2[7:0]
L = 2, M = 2, F = 2, S = 1	Lane 0 Lane 1	MOS0[15:8] M1S0[15:8]	MOS0[7:0] M1S0[7:0]		
L = 1, M = 2, F = 4, S = 1	Lane 0	MOS0[15:8]	MOS0[7:0]	M1S0[15:8]	M1S0[7:0]

¹ Mx is the converter number and Sy is the sample number. For example, MOS0 means Converter 0, Sample 0. Blank cells are not applicable.

PHYSICAL LAYER

The physical layer of the JESD204B interface, hereafter referred to as the deserializer, has eight identical channels. Each channel consists of the terminators, an equalizer, a clock and data recovery (CDR) circuit, and the 1:40 demux function (see Figure 91).

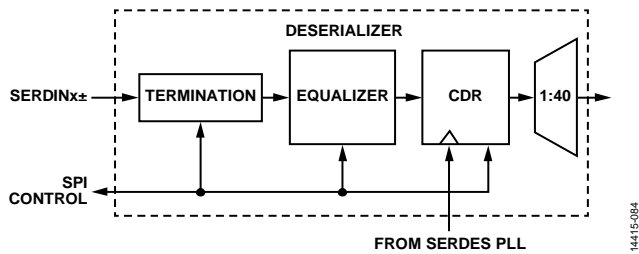

Figure 91. Deserializer Block Diagram

JESD204B data is input to the AD9163 via the SERDINx± 1.2 V differential input pins as per the JESD204B specification.

Interface Power-Up and Input Termination

Before using the JESD204B interface, it must be powered up by setting Register 0x200, Bit 0 = 0. In addition, each physical lane (PHY) that is not being used (SERDINx±) must be powered down. To do so, set the corresponding Bit x for Physical Lane x in Register 0x201 to 0 if the physical lane is being used, and to 1 if it is not being used.

The AD9163 autocalibrates the input termination to 50 Ω.

Before running the termination calibration, Register 0x2A7 and Register 0x2AE must be written as described in Table 16 to guarantee proper calibration. The termination calibration begins when Register 0x2A7, Bit 0 and Register 0x2AE, Bit 0 transition from low to high. Register 0x2A7 controls autocalibration for PHY 0, PHY 1, PHY 6, and PHY 7. Register 0x2AE controls autocalibration for PHY 2, PHY 3, PHY 4, and PHY 5.

The PHY termination autocalibration routine is as shown in Table 16.

Table 16. PHY Termination Autocalibration Routine

Address	Value	Description
0x2A7	0x01	Autotune PHY 0, PHY 1, PHY 6, and PHY 7 terminations
0x2AE	0x01	Autotune PHY 2, PHY 3, PHY 4, and PHY 5 terminations

The input termination voltage of the DAC is sourced externally via the VTT_1P2 pins (K3 and K11). Set V_{TT}, the termination voltage, by connecting it to VDD_1P2. It is recommended that the JESD204B inputs be ac-coupled to the JESD204B transmit device using 100 nF capacitors.

The calibration code of the termination can be read from Bits[3:0] in Register 0x2AC (PHY 0, PHY 1, PHY 6, PHY 7) and Register 0x2B3 (PHY 2, PHY 3, PHY 4, PHY 5). If needed, the termination values can be adjusted or set using several registers. The TERM_BLKx_CTRLREG1 registers (Register 0x2A8 and Register 0x2AF), can override the autocalibrated value. When set to 0xXXX0XXXX, the termination block autocalibrates, which is the normal, default setting. When set to 0xXXX1XXXX, the autocalibration value is overwritten with the value in Bits[3:1] of Register 0x2A8 and Register 0x2AF. Individual offsets from the autocalibration value for each lane can be programmed in Bits[3:0] of Register 0x2BB to Register 0x2C2. The value is a signed magnitude, with Bit 3 as the sign bit. The total range of the termination resistor value is about 94 Ω to 120 Ω, with approximately 3.5% increments across the range (for example, smaller steps at the bottom of the range than at the top).

Receiver Eye Mask

The AD9163 complies with the JESD204B specification regarding the receiver eye mask and is capable of capturing data that complies with this mask. Figure 92 shows the receiver eye mask normalized to the data rate interval with a 600 mV V_{TT} swing. See the JESD204B specification for more information regarding the eye mask and permitted receiver eye opening.

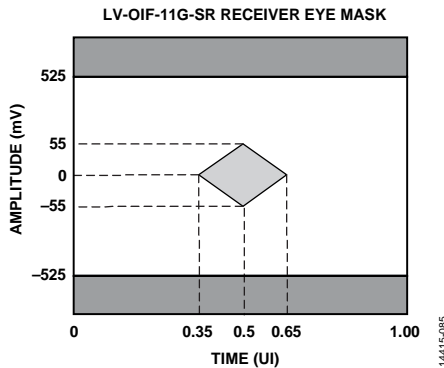

Figure 92. Receiver Eye Mask for 600 mV V_{TT} Swing

Clock Relationships

The following clocks rates are used throughout the rest of the JESD204B section. The relationship between any of the clocks can be derived from the following equations:

$$DataRate = (DACRate)/(InterpolationFactor)$$

$$LaneRate = (20 \times DataRate \times M)/L$$

$$ByteRate = LaneRate/10$$

This relationship comes from 8-bit/10-bit encoding, where each byte is represented by 10 bits.

$$PCLK\ Rate = ByteRate/4$$

The processing clock is used for a quad-byte decoder.

$$FrameRate = ByteRate/F$$

where *F* is defined as octets per frame per lane.

$$PCLK\ Factor = FrameRate/PCLK\ Rate = 4/F$$

where:

M is the JESD204B parameter for converters per link.

L is the JESD204B parameter for lanes per link.

F is the JESD204B parameter for octets per frame per lane.

SERDES PLL

Functional Overview of the SERDES PLL

The independent SERDES PLL uses integer N techniques to achieve clock synthesis. The entire SERDES PLL is integrated on chip, including the VCO and the loop filter. The SERDES PLL VCO operates over the range of 6 GHz to 12.5 GHz.

In the SERDES PLL, a VCO divider block divides the VCO clock by 2 to generate a 3 GHz to 6.25 GHz quadrature clock for the deserializer cores. This clock is the input to the clock and data recovery block that is described in the Clock and Data Recovery section.

The reference clock to the SERDES PLL is always running at a frequency, *f*_{REF}, that is equal to 1/40 of the lane rate (PCLK Rate). This clock is divided by a DivFactor value (set by SERDES_PLL_DIV_FACTOR) to deliver a clock to the phase frequency detector (PFD) block that is between 35 MHz and 80 MHz. Table 17 includes the respective SERDES_PLL_DIV_FACTOR register settings for each of the desired PLL_REF_CLK_RATE options available.

Table 17. SERDES PLL Divider Settings

Lane Rate (Gbps)	PLL_REF_CLK_RATE, Register 0x084, Bits[5:4]	SERDES_PLL_DIV_FACTOR Register 0x289, Bits[1:0]
0.750 to 1.5625	0b01 = 2×	0b10 = ÷1
1.5 to 3.125	0b00 = 1×	0b10 = ÷1
3 to 6.25	0b00 = 1×	0b01 = ÷2
6 to 12.5	0b00 = 1×	0b00 = ÷4

Register 0x280 controls the synthesizer enable and recalibration.

To enable the SERDES PLL, first set the PLL divider register (see Table 17). Then enable the SERDES PLL by writing Register 0x280, Bit 0 = 1. If a recalibration is needed, write Register 0x280, Bit 2 = 0b1 and then reset the bit to 0b0. The rising edge of the bit causes a recalibration to begin.

Confirm that the SERDES PLL is working by reading Register 0x281. If Register 0x281, Bit 0 = 1, the SERDES PLL has locked. If Register 0x281, Bit 3 = 1, the SERDES PLL was successfully calibrated. If Register 0x281, Bit 4 or Bit 5 is high, the PLL reaches the lower or upper end of its calibration band and must be recalibrated by writing 0 and then 1 to Register 0x280, Bit 2.

Clock and Data Recovery

The deserializer is equipped with a CDR circuit. Instead of recovering the clock from the JESD204B serial lanes, the CDR recovers the clocks from the SERDES PLL. The 3 GHz to 6.25 GHz output from the SERDES PLL, shown in Figure 94, is the input to the CDR.

A CDR sampling mode must be selected to generate the lane rate clock inside the device. If the desired lane rate is greater than 6.25 GHz, half rate CDR operation must be used. If the desired lane rate is less than 6.25 GHz, disable half rate operation. If the lane rate is less than 3 GHz, disable full rate and enable 2x oversampling to recover the appropriate lane rate clock. Table 18 gives a breakdown of CDR sampling settings that must be set depending on the lane rate value.

Table 18. CDR Operating Modes

Lane Rate (Gbps)	SPI_ENHALFRATE Register 0x230, Bit 5	SPI_DIVISION_RATE, Register 0x230, Bits[2:1]
0.750 to 1.5625	0 (full rate)	10b (divide by 4)
1.5 to 3.125	0 (full rate)	01b (divide by 2)
3 to 6.25	0 (full rate)	00b (no divide)
6 to 12.5	1 (half rate)	00b (no divide)

The CDR circuit synchronizes the phase used to sample the data on each serial lane independently. This independent phase adjustment per serial interface ensures accurate data sampling and eases the implementation of multiple serial interfaces on a PCB.

After configuring the CDR circuit, reset it and then release the reset by writing 1 and then 0 to Register 0x206, Bit 0.

Power-Down Unused PHYs

Note that any unused and enabled lanes consume extra power unnecessarily. Each lane that is not being used (SERDIN_{x±}) must be powered off by writing a 1 to the corresponding bit of PHY_PD (Register 0x201).

Equalization

To compensate for signal integrity distortions for each PHY channel due to PCB trace length and impedance, the AD9163 employs an easy to use, low power equalizer on each JESD204B channel. The AD9163 equalizers can compensate for insertion losses far greater than required by the JESD204B specification. The equalizers have two modes of operation that are determined by the EQ_POWER_MODE register setting in Register 0x268, Bits[7:6]. In low power mode (Register 0x268, Bits[7:6] = 2b'01) and operating at the maximum lane rate of 12.5 Gbps, the equalizer can compensate for up to 11.5 dB of insertion loss. In normal mode (Register 0x268, Bits[7:6] = 2b'00), the equalizer can compensate for up to 17.2 dB of insertion loss. This performance is shown in Figure 93 as an overlay to the JESD204B specification for insertion loss. Figure 93 shows the equalization performance at 12.5 Gbps, near the maximum baud rate for the AD9163.

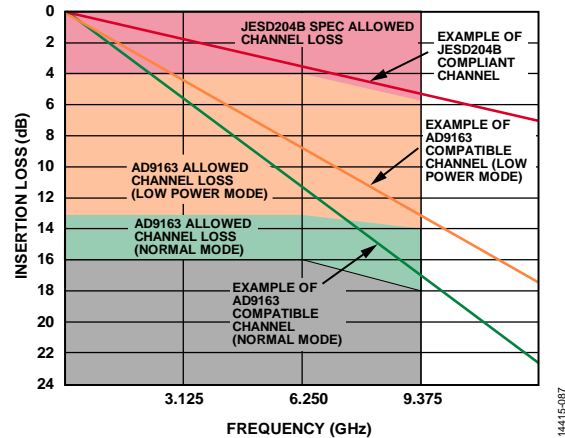

Figure 93. Insertion Loss Allowed

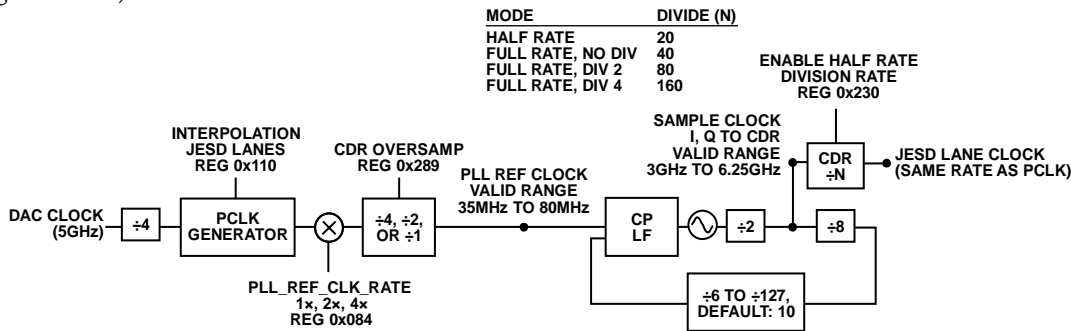

Figure 94. SERDES PLL Synthesizer Block Diagram Including VCO Divider Block

Figure 95 and Figure 96 are provided as points of reference for hardware designers and show the insertion loss for various lengths of well laid out stripline and microstrip transmission lines, respectively. See the Hardware Considerations section for specific layout recommendations for the JESD204B channel.

Low power mode is recommended if the insertion loss of the JESD204B PCB channels is less than that of the most lossy supported channel for low power mode (shown in Figure 93). If the insertion loss is greater than that, but still less than that of the most lossy supported channel for normal mode (shown in Figure 93), use normal mode. At 12.5 Gbps operation, the equalizer in normal mode consumes about 4 mW more power per lane used than in low power equalizer mode. Note that either mode can be used in conjunction with transmitter preemphasis to ensure functionality and/or optimize for power.

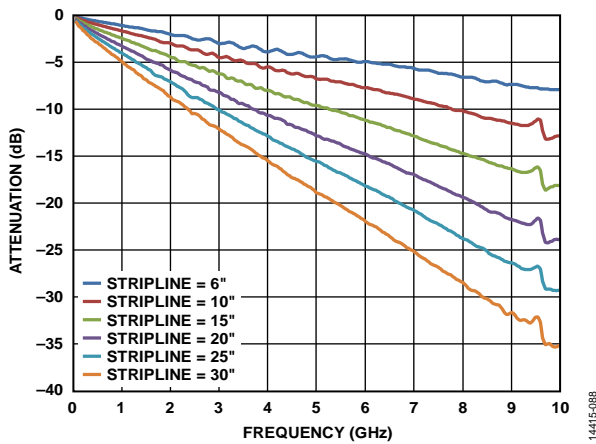

Figure 95. Insertion Loss of 50 Ohm Striplines on FR4

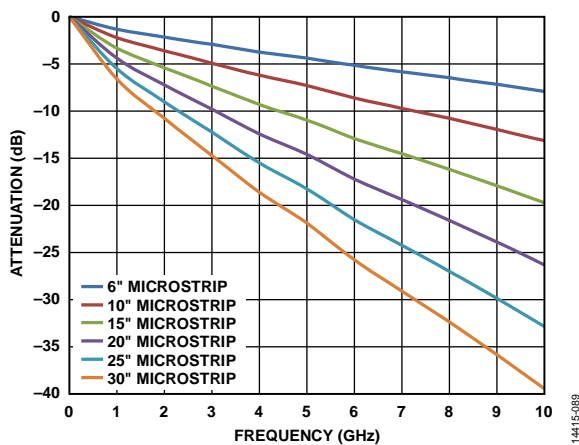

Figure 96. Insertion Loss of 50 Ohm Microstrips on FR4

DATA LINK LAYER

The data link layer of the AD9163 JESD204B interface accepts the deserialized data from the PHYs and deframes and descrambles them so that data octets are presented to the transport layer to be put into DAC samples. The architecture of the data link layer is shown in Figure 97. The data link layer consists of a synchronization FIFO for each lane, a crossbar switch, a deframer, and a descrambler.

The AD9163 can operate as a single-link high speed JESD204B serial data interface. All eight lanes of the JESD204B interface handle link layer communications such as code group synchronization (CGS), frame alignment, and frame synchronization.

The AD9163 decodes 8-bit/10-bit control characters, allowing marking of the start and end of the frame and alignment between serial lanes. Each AD9163 serial interface link can issue a synchronization request by setting its SYNCOUT± signal low. The synchronization protocol follows Section 4.9 of the JESD204B standard. When a stream of four consecutive /K/ symbols is received, the AD9163 deactivates the synchronization request by setting the SYNCOUT± signal high at the next internal LMFC rising edge. Then, the AD9163 waits for the transmitter to issue an initial lane alignment sequence (ILAS). During the ILAS, all lanes are aligned using the /A/ to /R/ character transition as described in the JESD204B Serial Link Establishment section. Elastic buffers hold early arriving lane data until the alignment character of the latest lane arrives. At this point, the buffers for all lanes are released and all lanes are aligned (see Figure 98).

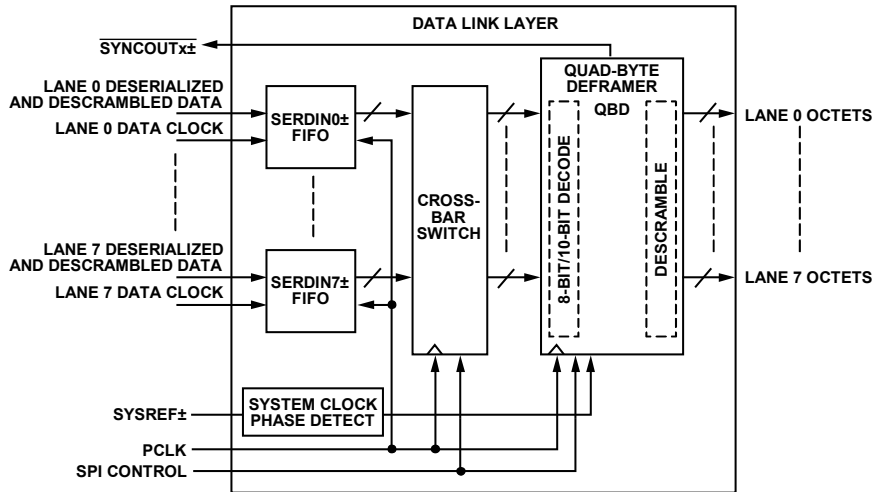

Figure 97. Data Link Layer Block Diagram

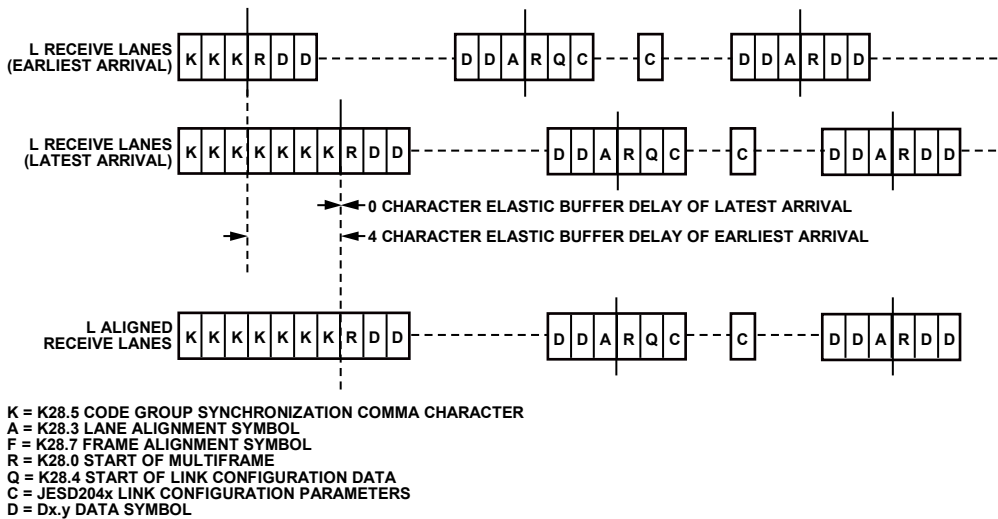

Figure 98. Lane Alignment During ILAS

JESD204B Serial Link Establishment

A brief summary of the high speed serial link establishment process for Subclass 1 is provided. See Section 5.3.3 of the JESD204B specifications document for complete details.

Step 1: Code Group Synchronization

Each receiver must locate /K/ (K28.5) characters in its input data stream. After four consecutive /K/ characters are detected on all link lanes, the receiver block deasserts the SYNCOUT± signal to the transmitter block at the receiver LMFC edge.

The transmitter captures the change in the SYNCOUT± signal and at a future transmitter LMFC rising edge starts the ILAS.

Step 2: Initial Lane Alignment Sequence

The main purposes of this phase are to align all the lanes of the link and to verify the parameters of the link.

Before the link is established, write each of the link parameters to the receiver device to designate how data is sent to the receiver block.

The ILAS consists of four or more multiframes. The last character of each multiframe is a multiframe alignment character, /A/. The first, third, and fourth multiframes are populated with predetermined data values. Note that Section 8.2 of the JESD204B specifications document describes the data ramp that is expected during ILAS. The AD9163 does not require this ramp. The deframer uses the final /A/ of each lane to align the ends of the multiframes within the receiver. The second multiframe contains an /R/ (K.28.0), /Q/ (K.28.4), and then data corresponding to the link parameters. Additional multiframes can be added to the ILAS if needed by the receiver. By default, the AD9163 uses four multiframes in the ILAS (this can be changed in Register 0x478). If using Subclass 1, exactly four multiframes must be used.

After the last /A/ character of the last ILAS, multiframe data begins streaming. The receiver adjusts the position of the /A/

character such that it aligns with the internal LMFC of the receiver at this point.

Step 3: Data Streaming

In this phase, data is streamed from the transmitter block to the receiver block.

Optionally, data can be scrambled. Scrambling does not start until the very first octet following the ILAS.

The receiver block processes and monitors the data it receives for errors, including the following:

- Bad running disparity (8-bit/10-bit error)
- Not in table (8-bit/10-bit error)
- Unexpected control character
- Bad ILAS
- Interlane skew error (through character replacement)

If any of these errors exist, they are reported back to the transmitter in one of the following ways (see the JESD204B Error Monitoring section for details):

- $\overline{\text{SYNCOUT}}_{\pm}$ signal assertion: resynchronization (SYNCOUT_{\pm} signal pulled low) is requested at each error for the last two errors. For the first three errors, an optional resynchronization request can be asserted when the error counter reaches a set error threshold.
- For the first three errors, each multiframe with an error in it causes a small pulse on SYNCOUT_{\pm} .
- Errors can optionally trigger an interrupt request (IRQ) event, which can be sent to the transmitter.

For more information about the various test modes for verifying the link integrity, see the JESD204B Test Modes section.

Lane First In/First Out (FIFO)

The FIFOs in front of the crossbar switch and deframer synchronize the samples sent on the high speed serial data interface with the deframer clock by adjusting the phase of the incoming data. The FIFO absorbs timing variations between the data source and the deframer; this allows up to two PCLK cycles of drift from the transmitter. The FIFO_STATUS_REG_0 register and FIFO_STATUS_REG_1 register (Register 0x30C and Register 0x30D, respectively) can be monitored to identify whether the FIFOs are full or empty.

Lane FIFO IRQ

An aggregate lane FIFO error bit is also available as an IRQ event. Use Register 0x020, Bit 2 to enable the FIFO error bit, and then use Register 0x024, Bit 2 to read back its status and reset the IRQ signal. See the Interrupt Request Operation section for more information.

Crossbar Switch

Register 0x308 to Register 0x30B allow arbitrary mapping of physical lanes ($\text{SERDIN}_{x\pm}$) to logical lanes used by the SERDES deframers.

Table 19. Crossbar Registers

Address	Bits	Logical Lane
0x308	[2:0]	SRC_LANE0
0x308	[5:3]	SRC_LANE1
0x309	[2:0]	SRC_LANE2
0x309	[5:3]	SRC_LANE3
0x30A	[2:0]	SRC_LANE4
0x30A	[5:3]	SRC_LANE5
0x30B	[2:0]	SRC_LANE6
0x30B	[5:3]	SRC_LANE7

Write each SRC_LANE_y with the number (x) of the desired physical lane ($\text{SERDIN}_{x\pm}$) from which to obtain data. By default, all logical lanes use the corresponding physical lane as their data source. For example, by default, $\text{SRC_LANE0} = 0$; therefore, Logical Lane 0 obtains data from Physical Lane 0 (SERDIN0_{\pm}). To use SERDIN4_{\pm} as the source for Logical Lane 0 instead, the user must write $\text{SRC_LANE0} = 4$.

Lane Inversion

Register 0x334 allows inversion of desired logical lanes, which can be used to ease routing of the $\text{SERDIN}_{x\pm}$ signals. For each Logical Lane x, set Bit x of Register 0x334 to 1 to invert it.

Deframer

The AD9163 consists of one quad-byte deframer (QBD). The deframer accepts the 8-bit/10-bit encoded data from the deserializer (via the crossbar switch), decodes it, and descrambles it into JESD204B frames before passing it to the transport layer to be converted to DAC samples. The deframer processes four symbols (or octets) per processing clock (PCLK) cycle.

The deframer uses the JESD204B parameters that the user has programmed into the register map to identify how the data is packed, and unpacks it. The JESD204B parameters are described in detail in the Transport Layer section; many of the parameters are also needed in the transport layer to convert JESD204B frames into samples.

Descrambler

The AD9163 provides an optional descrambler block using a self synchronous descrambler with the following polynomial: $1 + x^{14} + x^{15}$.

Enabling data scrambling reduces spectral peaks that are produced when the same data octets repeat from frame to frame. It also makes the spectrum data independent so that possible frequency selective effects on the electrical interface do not cause data dependent errors. Descrambling of the data is enabled by setting the SCR bit (Register 0x453, Bit 7) to 1.

Syncing LMFC Signals

The first step in guaranteeing synchronization across links and devices begins with syncing the LMFC signals. In Subclass 0, the LMFC signal is synchronized to an internal processing clock. In Subclass 1, LMFC signals are synchronized to an external SYSREF± signal.

SYSREF± Signal

The SYSREF± signal is a differential source synchronous input that synchronizes the LMFC signals in both the transmitter and receiver in a JESD204B Subclass 1 system to achieve deterministic latency.

The SYSREF± signal is a rising edge sensitive signal that is sampled by the device clock rising edge. It is best practice that the device clock and SYSREF± signals be generated by the same source, such as the [HMC7044](#) clock generator, so that the phase alignment between the signals is fixed. When designing for optimum deterministic latency operation, consider the timing distribution skew of the SYSREF± signal in a multipoint link system (multichip).

The [AD9163](#) supports a periodic SYSREF± signal. The periodicity can be continuous, strobed, or gapped periodic. The SYSREF± signal can always be dc-coupled (with a common-mode voltage of 0 V to 1.25 V). When dc-coupled, a small amount of common-mode current (<500 µA) is drawn from the SYSREF± pins. See Figure 99 for the SYSREF± internal circuit.

To avoid this common-mode current draw, use a 50% duty cycle periodic SYSREF± signal with ac coupling capacitors. If ac-coupled, the ac coupling capacitors combine with the resistors shown in Figure 99 to make a high-pass filter with an RC time constant of $\tau = RC$. Select C such that $\tau > 4/\text{SYSREF}\pm$ frequency. In addition, the edge rate must be sufficiently fast to meet the SYSREF± vs. DAC clock keep out window (KOW) requirements.

It is possible to use ac-coupled mode without meeting the frequency to time constant constraints ($\tau = RC$ and $\tau > 4/\text{SYSREF}\pm$ frequency) by using SYSREF± hysteresis (Register 0x088 and Register 0x089). However, using hysteresis increases the DAC clock KOW (Table 6 does not apply) by an amount depending on the SYSREF± frequency, level of hysteresis, capacitor choice, and edge rate.

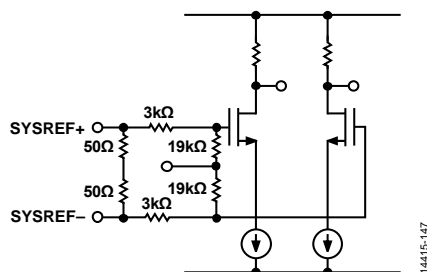

Figure 99. SYSREF± Input Circuit

Sync Processing Modes Overview

The [AD9163](#) supports several LMFC sync processing modes. These modes are one-shot, continuous, and monitor modes.

All sync processing modes perform a phase check to confirm that the LMFC is phase aligned to an alignment edge. In Subclass 1, the SYSREF± rising edge acts as the alignment edge; in Subclass 0, an internal processing clock acts as the alignment edge.

The SYSREF± signal is sampled by a divide by 4 version of the DAC clock. After SYSREF± is sampled, the phase of the DAC clock/4 used to sample SYSREF± is stored in Register 0x037, Bits[7:0] and Register 0x038, Bits[3:0] as a thermometer code. This offset can be used by the SERDES data transmitter (for example, FPGA) to align multiple DACs by accounting for this clock offset when transmitting data. See the Sync Procedure section for details on the procedure for syncing the LMFC signals.

One-Shot Sync Mode (SYNC_MODE = Register 0x03A, Bits[1:0] = 0b10)

In one-shot sync mode, a phase check occurs on only the first alignment edge that is received after the sync machine is armed. After the phase is aligned on the first edge, the [AD9163](#) transitions to monitor mode. Though an LMFC synchronization occurs only once, the SYSREF± signal can still be continuous. In this case, the phase is monitored and reported, but no clock phase adjustment occurs.

Continuous Sync Mode (SYNC_MODE = Register 0x03A, Bits[1:0] = 0b01)

Continuous mode must be used in Subclass 1 only with a periodic SYSREF± signal. In continuous mode, a phase check/alignment occurs on every alignment edge.

Continuous mode differs from one-shot mode in two ways. First, no SPI cycle is required to arm the device; the alignment edge seen after continuous mode is enabled results in a phase check. Second, a phase check occurs on every alignment edge in continuous mode.

Monitor Sync Mode (SYNC_MODE = Register 0x03A, Bits[1:0] = 0b00)

In monitor mode, the user can monitor the phase error in real time. Use this sync mode with a periodic SYSREF± signal. The phase is monitored and reported, but no clock phase adjustment occurs.

When an alignment request (SYSREF± edge) occurs, snapshots of the last phase error are placed into readable registers for reference (Register 0x037 and Register 0x038, Bits[3:0]), and the IRQ_SYSREF_JITTER interrupt is set, if appropriate.

Sync Procedure

The procedure for enabling the sync is as follows:

1. Set up the DAC; the SERDES PLL locks it, and enables the CDR (see the Start-Up Sequence section).
2. Set Register 0x039 (SYSREF± jitter window). A minimum of 4 DAC clock cycles is recommended. See Table 21 for settings.
3. Optionally, read back the SYSREF± count to check whether the SYSREF± pulses are being received.

- a. Set Register 0x036 = 0. Writing anything to SYSREF_COUNT resets the count.
- b. Set Register 0x034 = 0. Writing anything to SYNC_LMFC_STAT0 saves the data for readback and registers the count.
- c. Read SYSREF_COUNT from the value from Register 0x036.
4. Perform a one-shot sync.
 - a. Set Register 0x03A = 0x00. Clear one-shot mode if already enabled.
 - b. Set Register 0x03A = 0x02. Enable one-shot sync mode. The state machine enters monitor mode after a sync occurs.
5. Optionally, read back the sync SYNC_LMFC_STATx registers to verify that sync completed correctly.
 - a. Set Register 0x034 = 0. Register 0x034 must be written to read the value.
 - b. Read Register 0x035 and Register 0x034 to find the value of SYNC_LMFC_STATx. It is recommended to set SYNC_LMFC_STATx to 0 but it can be set to 4, or a LMFC period in DAC clocks – 4, due to jitter.
6. Optionally, read back the sync SYSREF_PHASEx register to identify which phase of the divide by 4 was used to sample SYSREF±. Read Register 0x038 and Register 0x037 as thermometer code. The MSBs of Register 0x037, Bits[7:4], normally show the thermometer code value.
7. Turn the link on (Register 0x300, Bit 0 = 1).
8. Read back Register 0x302 (dynamic link latency).
9. Repeat the reestablishment of the link several times (Step 1 to Step 7) and note the dynamic link latency values. Based on the values, program the LMFC delay (Register 0x304) and the LMFC variable (Register 0x306), and then restart the link.

Table 20. Sync Processing Modes

Sync Processing Mode	SYNC_MODE (Register 0x03A, Bits[1:0])
No synchronization	0b00
One shot	0b10
Continuous	0b01

Table 21. SYSREF± Jitter Window Tolerance

SYSREF± Jitter Window Tolerance (DAC Clock Cycles)	SYSREF_JITTER_WINDOW (Register 0x039, Bits[5:0]) ¹
±½	0x00
±4	0x04
±8	0x08
±12	0x0C
±16	0x10
±20	0x14
+24	0x18
±28	0x1C

¹ The two least significant digits are ignored because the SYSREF± signal is sampled with a divide by 4 version of the DAC clock. As a result, the jitter window is set by this divide by 4 clock rather than the DAC clock. It is recommended that at least a four-DAC clock SYSREF± jitter window be chosen.

Deterministic Latency

JESD204B systems contain various clock domains distributed throughout its system. Data traversing from one clock domain to a different clock domain can lead to ambiguous delays in the JESD204B link. These ambiguities lead to nonrepeatable latencies across the link from power cycle to power cycle with each new link establishment. Section 6 of the JESD204B specification addresses the issue of deterministic latency with mechanisms defined as Subclass 1 and Subclass 2.

The AD9163 supports JESD204B Subclass 0 and Subclass 1 operation, but not Subclass 2. Write the subclass to Register 0x458, Bits[7:5].

Subclass 0

This mode gives deterministic latency to within 32 DAC clock cycles. It does not require any signal on the SYSREF± pins, which can be left disconnected.

Subclass 0 still requires that all lanes arrive within the same LMFC cycle and the dual DACs must be synchronized to each other.

Subclass 1

This mode gives deterministic latency and allows the link to be synced to within four DAC clock periods. It requires an external SYSREF± signal that is accurately phase aligned to the DAC clock.

Deterministic Latency Requirements

Several key factors are required for achieving deterministic latency in a JESD204B Subclass 1 system.

- SYSREF± signal distribution skew within the system must be less than the desired uncertainty.
- SYSREF± setup and hold time requirements must be met for each device in the system.
- The total latency variation across all lanes, links, and devices must be ≤10 PCLK periods, which includes both variable delays and the variation in fixed delays from lane to lane, link to link, and device to device in the system.

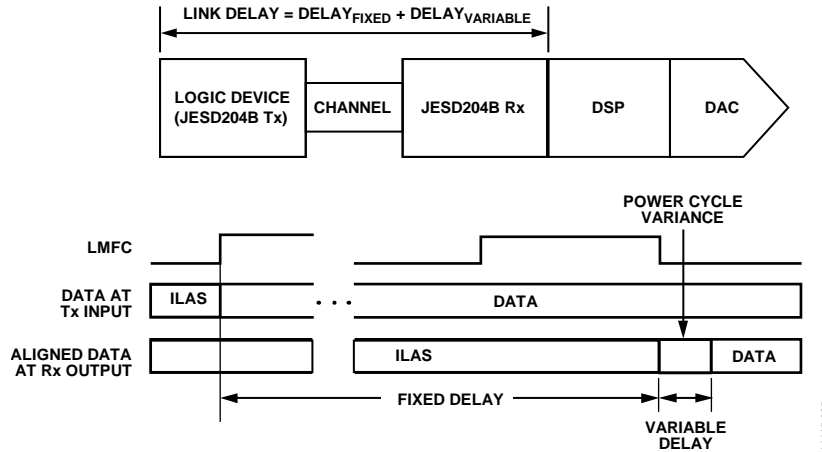

Figure 100. JESD204B Link Delay = Fixed Delay + Variable Delay

Link Delay

The link delay of a JESD204B system is the sum of the fixed and variable delays from the transmitter, channel, and receiver as shown in Figure 100.

For proper functioning, all lanes on a link must be read during the same LMFC period. Section 6.1 of the JESD204B specification states that the LMFC period must be larger than the maximum link delay. For the AD9163, this is not necessarily the case; instead, the AD9163 uses a local LMFC for each link (LMFC_{Rx}) that can be delayed from the SYSREF± aligned LMFC. Because the LMFC is periodic, this delay can account for any amount of fixed delay. As a result, the LMFC period must only be larger than the variation in the link delays, and the AD9163 can achieve proper performance with a smaller total latency. Figure 101 and Figure 102 show a case where the link delay is greater than an LMFC period. Note that it can be accommodated by delaying LMFC_{Rx}.

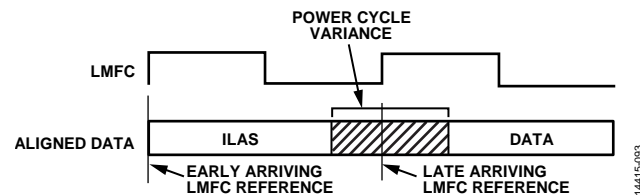

Figure 101. Link Delay > LMFC Period Example

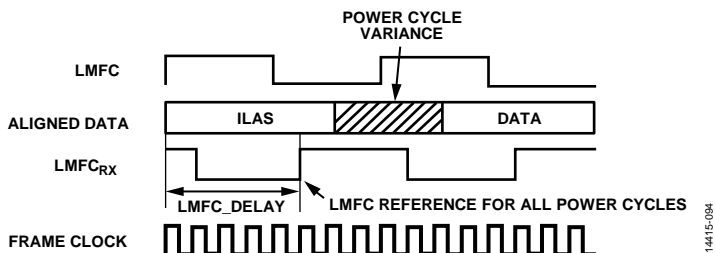

Figure 102. LMFC_DELAY_x to Compensate for Link Delay > LMFC

The method to select the LMFC_{Del} (Register 0x304) and LMFC_{Var} (Register 0x306) variables is described in the Link Delay Setup Example, With Known Delays section.

Setting LMFC_{Del} appropriately ensures that all the corresponding data samples arrive in the same LMFC period. Then LMFC_{Var} is written into the receive buffer delay (RBD) to absorb all link delay variation. This write ensures that all data samples have arrived before reading. By setting these to fixed values across runs and devices, deterministic latency is achieved.

The RBD described in the JESD204B specification takes values from 1 frame clock cycle to K frame clock cycles, and the RBD of the AD9163 takes values from 0 PCLK cycle to 10 PCLK cycles. As a result, up to 10 PCLK cycles of total delay variation can be absorbed. LMFC_{Var} and LMFC_{Del} are both in PCLK cycles. The PCLK factor, or number of frame clock cycles per PCLK cycle, is equal to 4/F. For more information on this relationship, see the Clock Relationships section.

Two examples follow that show how to determine LMFC_{Var} and LMFC_{Del}. After they are calculated, write LMFC_{Del} into Register 0x304 for all devices in the system, and write LMFC_{Var} to Register 0x306 for all devices in the system.

Link Delay Setup Example, With Known Delays

All the known system delays can be used to calculate LMFC_{Var} and LMFC_{Del}.

The example shown in Figure 103 is demonstrated in the following steps. Note that this example is in Subclass 1 to achieve deterministic latency, which has a PCLK factor (4/F) of 2 frame clock cycles per PCLK cycle, and uses K = 32 (frames/multiframe). Because PCBF_{Fixed} << PCLK Period, PCBF_{Fixed} is negligible in this example and not included in the calculations.

1. Find the receiver delays using Table 7.
 - $RxFixed = 12$ PCLK cycles
 - $RxVar = 2$ PCLK cycles
2. Find the transmitter delays. The equivalent table in the example JESD204B core (implemented on a GTH or GTX gigabit transceiver on a Virtex-6 FPGA) states that the delay is 56 ± 2 byte clock cycles.

3. Because the PCLK Rate = ByteRate/4 as described in the Clock Relationships section, the transmitter delays in PCLK cycles are calculated as follows:

$$TxFixed = 54/4 = 13.5 \text{ PCLK cycles}$$

$$TxVar = 4/4 = 1 \text{ PCLK cycle}$$
4. Calculate MinDelayLane as follows:

$$MinDelayLane = \text{floor}(RxFixed + TxFixed + PCBFixed)$$

$$= \text{floor}(12 + 13.5 + 0)$$

$$= \text{floor}(25.5)$$

$$MinDelayLane = 25$$
5. Calculate MaxDelayLane as follows:

$$MaxDelayLane = \text{ceiling}(RxFixed + RxVar + TxFixed + TxVar + PCBFixed)$$

$$= \text{ceiling}(12 + 2 + 13.5 + 1 + 0)$$

$$= \text{ceiling}(28.5)$$

$$MaxDelayLane = 29$$
6. Calculate LMFCVar as follows:

$$LMFCVar = (MaxDelay + 1) - (MinDelay - 1)$$

$$= (29 + 1) - (25 - 1) = 30 - 24$$

$$LMFCVar = 6 \text{ PCLK cycles}$$
7. Calculate LMFCDel as follows:

$$LMFCDel = (MinDelay - 1) \% (K/PCLockFactor)$$

$$= (25 - 1) \% (32/2)$$

$$= 24 \% 16$$

$$LMFCDel = 8 \text{ PCLK cycles}$$
8. Write LMFCDel to Register 0x304 for all devices in the system. Write LMFCVar to Register 0x306 for all devices in the system.

Link Delay Setup Example, Without Known Delay

If the system delays are not known, the AD9163 can read back the link latency between LMFC_{RX} for each link and the SYSREF± aligned LMFC. This information is then used to calculate LMFCVar and LMFCDel.

Figure 105 shows how DYN_LINK_LATENCY_0 (Register 0x302) provides a readback showing the delay (in PCLK cycles) between LMFC_{RX} and the transition from ILAS to the first data sample. By repeatedly power cycling and taking this measurement, the minimum and maximum delays across power cycles can be determined and used to calculate LMFCVar and LMFCDel.

In Figure 105, for Link A, Link B, and Link C, the system containing the AD9163 (including the transmitter) is power cycled and configured 20 times. The AD9163 is configured as described in the Sync Procedure section. Because the purpose of this exercise is to determine LMFCDel and LMFCVar, the LMFCDel value is programmed to 0 and the DYN_LINK_LATENCY_0 value is read from Register 0x302. The variation in the link latency over the 20 runs is shown in Figure 105, described as follows:

- Link A gives readbacks of 6, 7, 0, and 1. Note that the set of recorded delay values rolls over the edge of a multiframe at the boundary of K/PCLK factor = 8. Add the number of PCLK cycles per multiframe = 8 to the readback values of 0 and 1 because they rolled over the edge of the multiframe. Delay values range from 6 to 9.
- Link B gives delay values from 5 to 7.
- Link C gives delay values from 4 to 7.

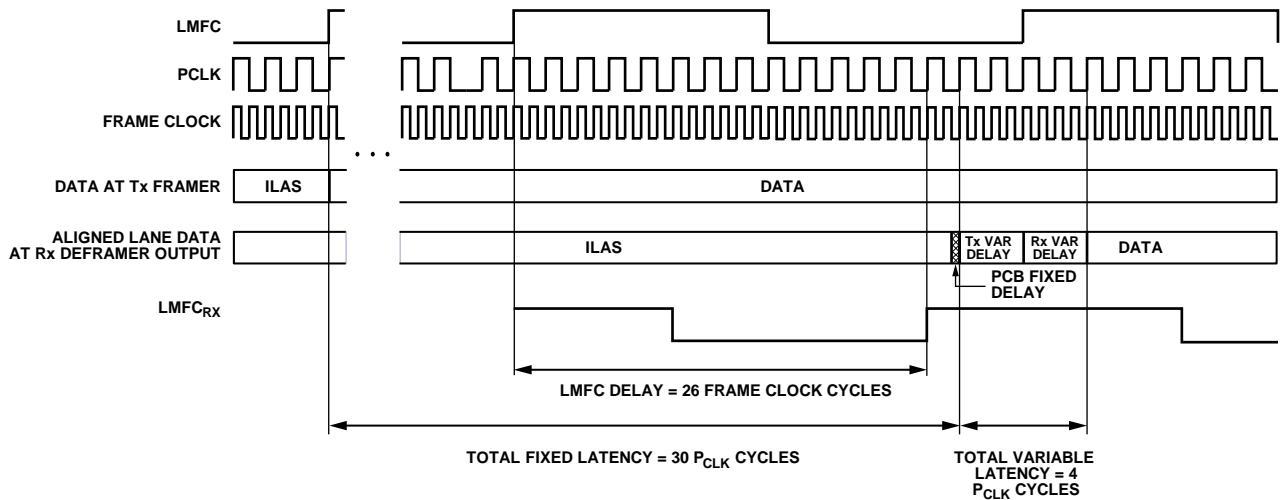

Figure 103. LMFC Delay Calculation Example

14415-096

The example shown in Figure 105 is demonstrated in the following steps. Note that this example is in Subclass 1 to achieve deterministic latency, which has a PCLK factor (FrameRate ÷ PCLK Rate) of 4 and uses K = 32; therefore PCLK cycles per multiframe = 8.

1. Calculate the minimum of all delay measurements across all power cycles, links, and devices as follows:
 $MinDelay = \min(\text{all Delay values}) = 4$
2. Calculate the maximum of all delay measurements across all power cycles, links, and devices as follows:
 $MaxDelay = \max(\text{all Delay values}) = 9$
3. Calculate the total delay variation (with guard band) across all power cycles, links, and devices as follows:

$$LMFCVar = (MaxDelay + 1) - (MinDelay - 1)$$

$$= (9 + 1) - (4 - 1) = 10 - 3 = 7 \text{ PCLK cycles}$$

4. Calculate the minimum delay in PCLK cycles (with guard band) across all power cycles, links, and devices as follows:
 $LMFCDel = (MinDelay - 1) \% (K/PCLK \text{ Factor})$
 $= (4 - 1) \% 32/4$
 $= 3 \% 8 = 3 \text{ PCLK cycles}$
5. Write LMFCDel to Register 0x304 for all devices in the system. Write LMFCVar to Register 0x306 for all devices in the system.

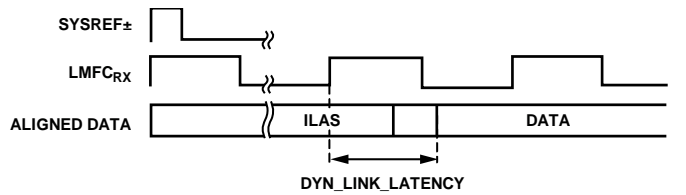

Figure 104. DYN_LINK_LATENCY_x Illustration

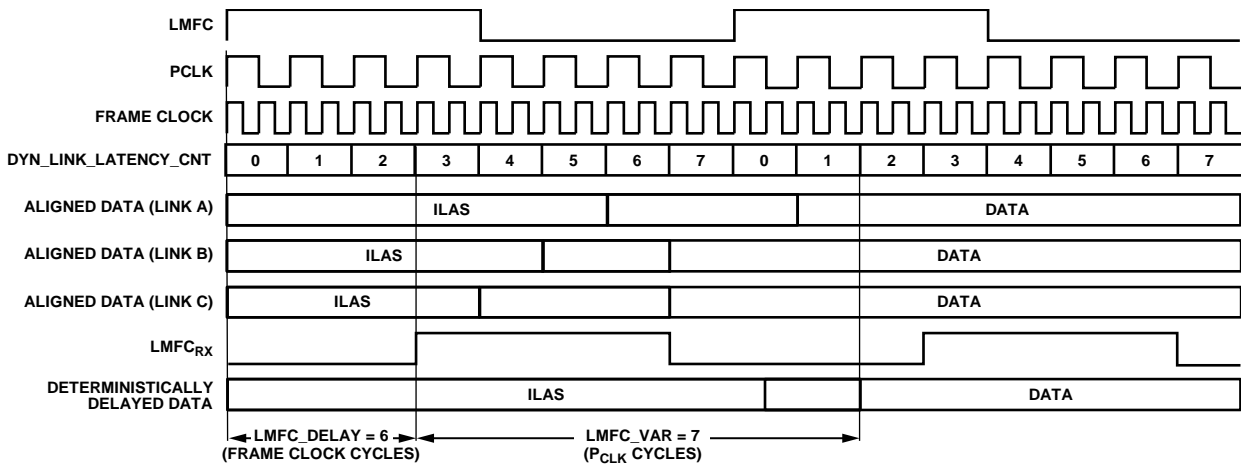

Figure 105. Multilink Synchronization Settings, Derived Method Example

TRANSPORT LAYER

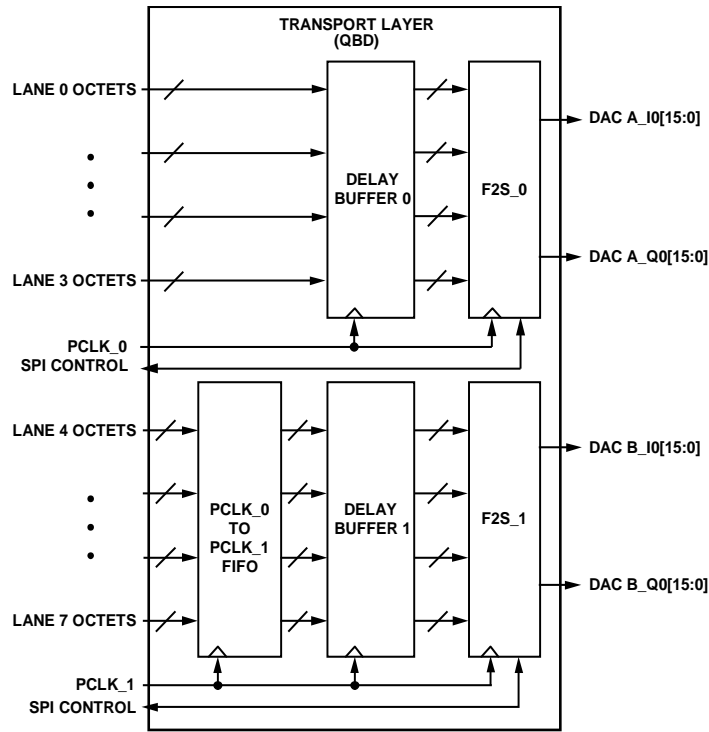

Figure 106. Transport Layer Block Diagram

The transport layer receives the descrambled JESD204B frames and converts them to DAC samples based on the programmed JESD204B parameters shown in Table 22. The device parameters are defined in Table 23.

Table 22. JESD204B Transport Layer Parameters

Parameter	Description
F	Number of octets per frame per lane: 1, 2, or 4
K	Number of frames per multiframe: K = 32
L	Number of lanes per converter device (per link), as follows: 4 or 8
M	Number of converters per device (per link), as follows: 2 (2 is used for the AD9163)
S	Number of samples per converter, per frame: 1 or 2

Table 23. JESD204B Device Parameters

Parameter	Description
CF	Number of control words per device clock per link. Not supported, must be 0.
CS	Number of control bits per conversion sample. Not supported, must be 0.
HD	High density user data format. Used when samples must be split across lanes. Set to 1 always, even when F does not equal 1. Otherwise, a link configuration error triggers and the IRQ_ILAS flag is set.
N	Converter resolution = 16.
N' (or NP)	Total number of bits per sample = 16.

Certain combinations of these parameters are supported by the AD9163. See Table 26 for a list of supported interpolation rates and the number of lanes that is supported for each rate. Table 26 lists the JESD204B parameters for each of the interpolation and number of lanes configuration, and gives an example lane rate for a 5 GHz DAC clock. Table 25 lists JESD204B parameters that have fixed values. A value of yes in Table 24 means the interpolation rate is supported for the number of lanes. A blank cell means it is not supported.

Table 24. Interpolation Rates and Number of Lanes

Interpolation	8	6	4	3	2	1
6x	Yes	Yes	Yes	Yes		
8x	Yes	Yes	Yes	Yes	Yes	
12x	Yes	Yes	Yes	Yes	Yes	
16x	Yes	Yes	Yes	Yes	Yes	Yes
24x	Yes	Yes	Yes	Yes	Yes	Yes

Table 25. JESD204B Parameters with Fixed Values

Parameter	Value
K	32
N	16
NP	16
CF	0
HD	1
CS	0

Table 26. JESD204B Parameters for Interpolation Rate and Number of Lanes

Interpolation Rate	No. of Lanes	M	F	S	PCLK Period (DAC Clocks)	LMFC Period (DAC Clocks)	Lane Rate at 5 GHz DAC Clock (GHz)
6	3	2	4	3	18	576	11.11
6	4	2	1	1	24	192	8.33
6	6	2	2	3	36	576	5.55
6	8	2	1	2	48	384	4.16
8	2	2	2	1	16	256	12.5
8	3	2	4	3	24	768	8.33
8	4	2	1	1	32	256	6.25
8	6	2	2	3	48	768	4.16
8	8	2	1	2	64	512	3.12
12	2	2	2	1	24	384	8.33
12	3	2	4	3	36	1152	5.55
12	4	2	1	1	48	384	4.16
12	6	2	2	3	72	1152	2.77
12	8	2	1	2	96	768	2.08
16	1	2	4	1	16	512	12.5
16	2	2	2	1	32	512	6.25
16	3	2	4	3	48	1536	4.16
16	4	2	1	1	64	512	3.12
16	6	2	2	3	96	1536	2.08
16	8	2	1	2	128	1024	1.56
24	1	2	4	1	24	768	8.33
24	2	2	2	1	48	768	4.16
24	3	2	4	3	72	2304	2.77
24	4	2	1	1	96	768	2.08
24	6	2	2	3	144	2304	1.38
24	8	2	1	2	192	1536	1.04

Configuration Parameters

The AD9163 modes refer to the link configuration parameters for L, K, M, N, NP, S, and F. Table 27 provides the description and addresses for these settings.

Table 27. Configuration Parameters

JESD204B Setting	Description	Address
L – 1	Number of lanes minus 1.	Register 0x453, Bits[4:0]
F – 1	Number of ((octets per frame) per lane) minus 1.	Register 0x454, Bits[7:0]
K – 1	Number of frames per multiframe minus 1.	Register 0x455, Bits[4:0]
M – 1	Number of converters minus 1.	Register 0x456, Bits[7:0]
N – 1	Converter bit resolution minus 1.	Register 0x457, Bits[4:0]
NP – 1	Bit packing per sample minus 1.	Register 0x458, Bits[4:0]
S – 1	Number of ((samples per converter) per frame) minus 1.	Register 0x459, Bits[4:0]
HD	High density format. Set to 1 if F = 1. Leave at 0 if F ≠ 1.	Register 0x45A, Bit 7
DID	Device ID. Match the device ID sent by the transmitter.	Register 0x450, Bits[7:0]
BID	Bank ID. Match the bank ID sent by the transmitter.	Register 0x451, Bits[7:0]
LID0	Lane ID for Lane 0. Match the Lane ID sent by the transmitter on Logical Lane 0.	Register 0x452, Bits[4:0]
JESDV	JESD204x version. Match the version sent by the transmitter (0x0 = JESD204A, 0x1 = JESD204B).	Register 0x459, Bits[7:5]

Data Flow Through the JESD204B Receiver

The link configuration parameters determine how the serial bits on the JESD204B receiver interface are deframed and passed on to the DACs as data samples.

Deskewing and Enabling Logical Lanes

After proper configuration, the logical lanes are automatically deskewed. All logical lanes are enabled or not based on the lane number setting in Register 0x110, Bits[7:4]. The physical lanes are all powered up by default.

To disable power to physical lanes that are not being used, set Bit x in Register 0x201 to 1 to disable Physical Lane x, and keep it at 0 to enable it.

JESD204B TEST MODES

PHY PRBS Testing

The JESD204B receiver on the AD9163 includes a PRBS pattern checker on the back end of its physical layer. This functionality enables bit error rate (BER) testing of each physical lane of the JESD204B link. The PHY PRBS pattern checker does not require that the JESD204B link be established. It can synchronize with a PRBS7, PRBS15, or PRBS31 data pattern. PRBS pattern verification can be done on multiple lanes at once. The error

counts for failing lanes are reported for one JESD204B lane at a time. The process for performing PRBS testing on the AD9163 is as follows:

1. Start sending a PRBS7, PRBS15, or PRBS31 pattern from the JESD204B transmitter.
2. Select and write the appropriate PRBS pattern to Register 0x316, Bits[3:2], as shown in Table 28.
3. Enable the PHY test for all lanes being tested by writing to PHY_TEST_EN (Register 0x315). Each bit of Register 0x315 enables the PRBS test for the corresponding lane. For example, writing a 1 to Bit 0 enables the PRBS test for Physical Lane 0.
4. Toggle PHY_TEST_RESET (Register 0x316, Bit 0) from 0 to 1 then back to 0.
5. Set PHY_PRBS_TEST_THRESHOLD_xBITS (Bits[23:0], Register 0x319 to Register 0x317) as desired.
6. Write a 0 and then a 1 to PHY_TEST_START (Register 0x316, Bit 1). The rising edge of PHY_TEST_START starts the test.
 - a. (Optional) In some cases, it may be necessary to repeat Step 4 at this point. Toggle PHY_TEST_RESET (Register 0x316, Bit 0) from 0 to 1, then back to 0.
7. Wait 500 ms.
8. Stop the test by writing PHY_TEST_START (Register 0x316, Bit 1) = 0.
9. Read the PRBS test results.
 - a. Each bit of PHY_PRBS_PASS (Register 0x31D) corresponds to one SERDES lane (0 = fail, 1 = pass).

The number of PRBS errors seen on each failing lane can be read by writing the lane number to check (0 to 7) in PHY_SRC_ERR_CNT (Register 0x316, Bits[6:4]) and reading the PHY_PRBS_ERR_COUNT (Register 0x31C to Register 0x31A). The maximum error count is $2^{24}-1$. If all bits of Register 0x31C to Register 0x31A are high, the maximum error count on the selected lane is exceeded.

Table 28. PHY PRBS Pattern Selection

PHY_PRBS_PAT_SEL Setting (Register 0x316, Bits[3:2])	PRBS Pattern
0b00 (default)	PRBS7
0b01	PRBS15
0b10	PRBS31

Transport Layer Testing

The JESD204B receiver in the AD9163 supports the short transport layer (STPL) test as described in the JESD204B standard. This test can be used to verify the data mapping between the JESD204B transmitter and receiver. To perform this test, this function must be implemented in the logic device and enabled there. Before running the test on the receiver side, the link must be established and running without errors.

The STPL test ensures that each sample from each converter is mapped appropriately according to the number of converters (M) and the number of samples per converter (S). As specified in the JESD204B standard, the converter manufacturer specifies what test samples are transmitted. Each sample must have a

unique value. For example, if $M = 2$ and $S = 2$, four unique samples are transmitted repeatedly until the test is stopped. The expected sample must be programmed into the device and the expected sample is compared to the received sample one sample at a time until all are tested. The process for performing this test on the AD9163 is described as follows:

1. Synchronize the JESD204B link.
2. Enable the STPL test at the JESD204B Tx.
3. Depending on JESD204B case, there may be up to two DACs, and each frame may contain up to four DAC samples. Configure the SHORT_TPL_REF_SP_MSB bits (Register 0x32E) and SHORT_TPL_REF_SP_LSB bits (Register 0x32D) to match one of the samples for one converter within one frame.
4. Set SHORT_TPL_SP_SEL (Register 0x32C, Bits[7:4]) to select the sample within one frame for the selected converter according to Table 29.
5. Set SHORT_TPL_TEST_EN (Register 0x32C, Bit 0) to 1.
6. Set SHORT_TPL_TEST_RESET (Register 0x32C, Bit 1) to 1, then back to 0.

7. Wait for the desired time. The desired time is calculated as $1/(\text{sample rate} \times \text{BER})$. For example, given a bit error rate of $\text{BER} = 1 \times 10^{-10}$ and a sample rate = 1 GSPS, the desired time = 10 sec. Then, set SHORT_TPL_TEST_EN to 0.
8. Read the test result at SHORT_TPL_FAIL (Register 0x32F, Bit 0).
9. Choose another sample for the same or another converter to continue with the test, until all samples for both converters from one frame are verified. (Note that the converter count is $M = 2$ for all interpolator modes on the AD9163 to enable complex signal processing.)

Consult Table 29 for a guide to the test sample alignment. Note that the sample order for 1x, eight-lane mode has Sample 1 and Sample 2 swapped. Also, the STPL test for the three-lane and six-lane options is not functional and always fails.

Table 29. Short TPL Test Samples Assignment¹

JESD204x Mode	Required Samples from JESD204x Tx	Samples Assignment
6x Eight-Lane (L = 8, M = 2, F = 1, S = 2) 8x Eight-Lane (L = 8, M = 2, F = 1, S = 2) 12x Eight-Lane (L = 8, M = 2, F = 1, S = 2) 16x Eight-Lane (L = 8, M = 2, F = 1, S = 2) 24x Eight-Lane (L = 8, M = 2, F = 1, S = 2)	Send four samples: M0S0, M0S1, M1S0, M1S1, and repeat	SP0: M0S0, SP4: M0S0, SP8: M0S0, SP12: M0S0 SP1: M1S0, SP5: M1S0, SP9: M1S0, SP13: M1S0 SP2: M0S1, SP6: M0S1, SP10: M0S1, SP14: M0S1 SP3: M1S1, SP7: M1S1, SP11: M1S1, SP15: M1S1
6x Six-Lane (L = 6, M = 2, F = 2, S = 3) 8x Six-Lane (L = 6, M = 2, F = 2, S = 3) 12x Six-Lane (L = 6, M = 2, F = 2, S = 3) 16x Six-Lane (L = 6, M = 2, F = 2, S = 3) 24x Six-Lane (L = 6, M = 2, F = 2, S = 3) 4x Three-Lane (L = 3, M = 2, F = 4, S = 3) 6x Three-Lane (L = 3, M = 2, F = 4, S = 3) 8x Three-Lane (L = 3, M = 2, F = 4, S = 3) 12x Three-Lane (L = 3, M = 2, F = 4, S = 3) 16x Three-Lane (L = 3, M = 2, F = 4, S = 3) 24x Three-Lane (L = 3, M = 2, F = 4, S = 3)	Send six samples: M0S0, M0S1, M0S2, M1S0, M1S1, M1S2, and repeat	Test hardware is not functional; STPL always fails
6x Four-Lane (L = 4, M = 2, F = 1, S = 1) 8x Four-Lane (L = 4, M = 2, F = 1, S = 1) 12x Four-Lane (L = 4, M = 2, F = 1, S = 1) 16x Four-Lane (L = 4, M = 2, F = 1, S = 1) 24x Four-Lane (L = 4, M = 2, F = 1, S = 1) 8x Two-Lane (L = 2, M = 2, F = 2, S = 1) 12x Two-Lane (L = 2, M = 2, F = 2, S = 1) 16x Two-Lane (L = 2, M = 2, F = 2, S = 1) 24x Two-Lane (L = 2, M = 2, F = 2, S = 1) 16x One-Lane (L = 1, M = 2, F = 4, S = 1) 24x One-Lane (L = 1, M = 2, F = 4, S = 1)	Send two samples: M0S0, M1S0, repeat	SP0: M0S0, SP4: M0S0, SP8: M0S0, SP12: M0S0 SP1: M1S0, SP5: M1S0, SP9: M1S0, SP13: M1S0 SP2: M0S0, SP6: M0S0, SP10: M0S0, SP14: M0S0 SP3: M1S0, SP7: M1S0, SP11: M1S0, SP15: M1S0

¹ Mx is the converter number and Sy is the sample number. For example, M0S0 means Converter 0, Sample 0. SPx is the sample pattern word number. For example, SP0 means Sample Pattern Word 0.

Repeated CGS and ILAS Test

As per Section 5.3.3.8.2 of the JESD204B specification, the AD9163 can check that a constant stream of /K28.5/ characters is being received, or that CGS followed by a constant stream of ILAS is being received.

To run a repeated CGS test, send a constant stream of /K28.5/ characters to the AD9163 SERDES inputs. Next, set up the device and enable the links. Ensure that the /K28.5/ characters are being received by verifying that $\overline{\text{SYNCOUT}}_{\pm}$ is deasserted and that CGS has passed for all enabled link lanes by reading Register 0x470.

To run the CGS followed by a repeated ILAS sequence test, follow the procedure to set up the links, but before performing the last write (enabling the links), enable the ILAS test mode by writing a 1 to Register 0x477, Bit 7. Then, enable the links. When the device recognizes four CGS characters on each lane, it deasserts the $\overline{\text{SYNCOUT}}_{\pm}$. At this point, the transmitter starts sending a repeated ILAS sequence.

Read Register 0x473 to verify that initial lane synchronization has passed for all enabled link lanes.

JESD204B ERROR MONITORING

Disparity, Not in Table, and Unexpected Control (K) Character Errors

As per Section 7.6 of the JESD204B specification, the AD9163 can detect disparity errors, not in table (NIT) errors, and unexpected control character errors, and can optionally issue a sync request and reinitialize the link when errors occur.

Note that the disparity error counter counts all characters with invalid disparity, regardless of whether they are in the 8-bit/10-bit decoding table. This is a minor deviation from the JESD204B specification, which only counts disparity errors when they are in the 8-bit/10-bit decoding table.

Several other interpretations of the JESD204B specification are noted in this section. When three NIT errors are injected to one lane and QUAL_RDERR (Register 0x476, Bit 4) = 1, the readback values of the bad disparity error (BDE) count register is 1. Reporting of disparity errors that occur at the same character position of an NIT error is disabled. No such disabling is performed for the disparity errors in the characters after an NIT error. Therefore, it is expected behavior that an NIT error may result in a BDE error.

A resync is triggered when four NIT errors are injected with Register 0x476, Bit 4 = 1. When this bit is set, the error counter does not distinguish between a concurrent invalid symbol with the wrong running disparity but is in the 8-bit/10-bit decoding table, and an NIT error. Thus, a resync can be triggered when four NIT errors are injected because they are not distinguished from disparity errors.

Checking Error Counts

The error count can be checked for disparity errors, NIT errors, and unexpected control character errors. The error counts are

on a per lane and per error type basis. Each error type and lane has a register dedicated to it. To check the error count, the following steps must be performed:

1. Choose and enable which errors to monitor by selecting them in Register 0x480, Bits[5:3] to Register 0x487, Bits[5:3]. Unexpected K (UEK) character, BDE, and NIT error monitoring can be selected for each lane by writing a 1 to the appropriate bit, as described in the register map. These bits are enabled by default.
2. The corresponding error counter reset bits are in Register 0x480, Bits[2:0] to Register 0x487, Bits[2:0]. Write a 0 to the corresponding bit to reset that error counter.
3. Registers 0x488, Bits[2:0] to Register 0x48F, Bits[2:0] have the terminal count hold indicator for each error counter. If this flag is enabled, when the terminal error count of 0xFF is reached, the counter ceases counting and holds that value until reset. Otherwise, it wraps to 0x00 and continues counting. Select the desired behavior and program the corresponding register bits per lane.

Check for Error Count Over Threshold

To check for the error count over threshold, follow these steps:

1. Define the error counter threshold. The error counter threshold can be set to a user defined value in Register 0x47C, or left to the default value of 0xFF. When the error threshold is reached, an IRQ is generated or $\overline{\text{SYNCOUT}}_{\pm}$ is asserted or both, depending on the mask register settings. This one error threshold is used for all three types of errors (UEK, NIT, and BDE).
2. Set the $\overline{\text{SYNC_ASSERT_MASK}}$ bits. The $\overline{\text{SYNCOUT}}_{\pm}$ assertion behavior is set in Register 0x47D, Bits[2:0]. By default, when any error counter of any lane is equal to the threshold, it asserts $\overline{\text{SYNCOUT}}_{\pm}$ (Register 0x47D, Bits[2:0] = 0b111).
3. Read the error count reached indicator. Each error counter has a terminal count reached indicator, per lane. This indicator is set to 1 when the terminal count of an error counter for a particular lane has been reached. These status bits are located in Register 0x490, Bits[2:0] to Register 0x497, Bits[2:0]. These registers also indicate whether a particular lane is active by setting Bit 3 = 0b1.

Error Counter and IRQ Control

For error counter and IRQ control, follow these steps:

1. Enable the JESD204B interrupts. The interrupts for the UEK, NIT, and BDE error counters are in Register 0x4B8, Bits[7:5]. There are other interrupts to monitor when bringing up the link, such as lane deskewing, initial lane sync, good check sum, frame sync, code group sync (Register 0x4B8, Bits[4:0]), and configuration mismatch (Register 0x4B9, Bit 0). These bits are off by default but can be enabled by writing 0b1 to the corresponding bit.

2. Read the JESD204B interrupt status. The interrupt status bits are in Register 0x4BA, Bits[7:0] and Register 0x4BB, Bit 0, with the status bit position corresponding to the enable bit position.
3. It is recommended to enable all interrupts that are planned to be used prior to bringing up the JESD204B link. When the link is up, the interrupts can be reset and then used to monitor the link status.

Monitoring Errors via SYNCOUT±

When one or more disparity, NIT, or unexpected control character errors occur, the error is reported on the SYNCOUT± pin as per Section 7.6 of the JESD204B specification. The JESD204B specification states that the SYNCOUT± signal is asserted for exactly two frame periods when an error occurs. For the AD9163, the width of the SYNCOUT± pulse can be programmed to ½, 1, or 2 PCLK cycles. The settings to achieve a SYNCOUT± pulse of two frame clock cycles are given in Table 30.

Table 30. Setting SYNCOUT± Error Pulse Duration

F	PCLK Factor (Frames/PCLK)	SYNC_ERR_DUR (Register 0x312, Bits[7:4]) Setting ¹
1	4	0 (default)
2	2	1
4	1	2

¹ These register settings assert the SYNCOUT± signal for two frame clock cycle pulse widths.

Unexpected Control Character, NIT, Disparity IRQs

For UEK character, NIT, and disparity errors, error count over the threshold events are available as IRQ events. Enable these events by writing to Register 0x4B8, Bits[7:5]. The IRQ event status can be read at Register 0x4BA, Bits[7:5] after the IRQs are enabled.

See the Error Counter and IRQ Control section for information on resetting the IRQ. See the Interrupt Request Operation section for more information on IRQs.

Errors Requiring Reinitializing

A link reinitialization automatically occurs when four invalid disparity characters are received as per Section 7.1 of the JESD204B specification. When a link reinitialization occurs, the resync request is five frames and nine octets long.

The user can optionally reinitialize the link when the error count for disparity errors, NIT errors, or UEK character errors reaches a programmable error threshold. The process to enable the reinitialization feature for certain error types is as follows:

1. Choose and enable which errors to monitor by selecting them in Register 0x480, Bits[5:3] to Register 0x487, Bits[5:3]. UEK, BDE, and NIT error monitoring can be selected for each lane by writing a 1 to the appropriate bit, as described in Table 45. These are enabled by default.

2. Enable the sync assertion mask for each type of error by writing to SYNC_ASSERT_MASK (Register 0x47D, Bits[2:0]) according to Table 31.
3. Program the desired error counter threshold into ERRORTHRES (Register 0x47C).
4. For each error type enabled in the SYNC_ASSERT_MASK register, if the error counter on any lane reaches the programmed threshold, SYNCOUT± falls, issuing a sync request. Note that all error counts are reset when a link reinitialization occurs. The IRQ does not reset and must be reset manually.

Table 31. Sync Assertion Mask (SYNC_ASSERT_MASK)

Addr.	Bit No.	Bit Name	Description
0x47D	2	BDE	Set to 1 to assert SYNCOUT± if the disparity error count reaches the threshold
	1	NIT	Set to 1 to assert SYNCOUT± if the NIT error count reaches the threshold
	0	UEK	Set to 1 to assert SYNCOUT± if the UEK character error count reaches the threshold

CGS, Frame Sync, Checksum, and ILAS Monitoring

Register 0x470 to Register 0x473 can be monitored to verify that each stage of the JESD204B link establishment has occurred.

Bit x of CODE_GRP_SYNC (Register 0x470) is high if Link Lane x received at least four K28.5 characters and passed code group synchronization.

Bit x of FRAME_SYNC (Register 0x471) is high if Link Lane x completed initial frame synchronization.

Bit x of GOOD_CHECKSUM (Register 0x472) is high if the checksum sent over the lane matches the sum of the JESD204B parameters sent over the lane during ILAS for Link Lane x. The parameters can be added either by summing the individual fields in registers or summing the packed register. If Register 0x300, Bit 6 = 0 (default), the calculated checksums are the lower eight bits of the sum of the following fields: DID, BID, LID, SCR, L – 1, F – 1, K – 1, M – 1, N – 1, SUBCLASSV, NP – 1, JESDV, S – 1, and HD. If Register 0x300, Bit 6 = 1, the calculated checksums are the lower eight bits of the sum of Register 0x400 to Register 0x40C and LID.

Bit x of INIT_LANE_SYNC (Register 0x473) is high if Link Lane x passed the initial lane alignment sequence.

CGS, Frame Sync, Checksum, and ILAS IRQs

Fail signals for CGS, frame sync, checksum, and ILAS are available as IRQ events. Enable them by writing to Register 0x4B8, Bits[3:0]. The IRQ event status can be read at Register 0x4BA, Bits[3:0] after the IRQs are enabled. Write a 1 to Register 0x4BA, Bit 0 to reset the CGS IRQ. Write a 1 to Register 0x4BA, Bit 1 to reset the frame sync IRQ. Write a 1 to Register 0x4BA, Bit 2 to reset the checksum IRQ. Write a 1 to Register 0x4BA, Bit 3 to reset the ILAS IRQ.

See the Interrupt Request Operation section for more information.

Configuration Mismatch IRQ

The AD9163 has a configuration mismatch flag that is available as an IRQ event. Use Register 0x4B9, Bit 0 to enable the mismatch flag (it is enabled by default), and then use Register 0x4BB, Bit 0

to read back its status and reset the IRQ signal. See the Interrupt Request Operation section for more information.

The configuration mismatch event flag is high when the link configuration settings (in Register 0x450 to Register 0x45D) do not match the JESD204B transmitted settings (Register 0x400 to Register 0x40D).

This function is different from the good checksum flags in Register 0x472. The good checksum flags ensure that the transmitted checksum matches a calculated checksum based on the transmitted settings. The configuration mismatch event ensures that the transmitted settings match the configured settings.

HARDWARE CONSIDERATIONS

See the Applications Information section for information on hardware considerations.

MAIN DIGITAL DATAPATH

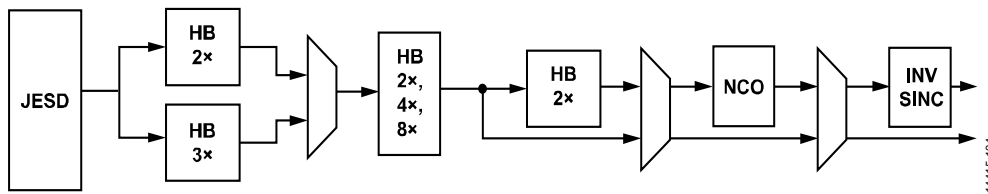

Figure 107. Block Diagram of the Main Digital Datapath

The block diagram in Figure 107 shows the functionality of the main digital datapath. The digital processing includes an input interpolation block with the choice of bypass (1×), 2×, or 3× interpolation, three additional 2× half-band interpolation filters, a final 2× NRZ mode interpolator filter, FIR85, that can be bypassed, and a quadrature modulator that consists of a 48-bit NCO and an inverse sinc block.

All of the interpolation filters accept in-phase (I) and quadrature (Q) data streams as a complex data stream. Similarly, the quadrature modulator and inverse sinc function also accept input data as a complex data stream. Thus, any use of the digital datapath functions requires the input data to be a complex data stream.

In bypass mode (1× interpolation), the input data stream is expected to be real data.

Table 32. Pipeline Delay (Latency) for Various DAC Blocks

Mode	FIR85 On	Filter Bandwidth	Inverse Sinc	NCO	Pipeline Delay ¹ (f _{DAC} Clocks)
6×	No	80%	No	No	332
8×	No	80%	No	No	602
12×	No	80%	No	No	674
16×	No	80%	No	No	1188
24×	No	80%	No	No	1272

¹ The pipeline delay given is a representative number, and may vary by a cycle or two based on the internal handoff timing conditions at startup.

The pipeline delay changes based on the digital datapath functions that are selected. See Table 32 for examples of the pipeline delay per block. These delays are in addition to the JESD204B latency.

DATA FORMAT

The input data format for all modes on the AD9163 is 16-bit, twos complement. The digital datapath and the DAC decoder operate in twos complement format. The DAC is a current steering DAC and cannot represent 0—it must either source or sink current. As a result, when the 0 of twos complement is represented in the DAC, it is a +1, and all the positive values thereafter are shifted by +1. This mapping error introduces a ½ LSB shift in the DAC output. The leakage can become apparent when using the NCO to shift a signal that is above or below 0 Hz when synthesized. The NCO frequency is seen as a small spur at the NCO FTW.

To avoid the NCO frequency leakage, operate the DAC with a slight digital backoff of one or several codes, and then add 1 to all values in the data stream. These actions remove the NCO frequency leakage but cause a half LSB dc offset. This small dc offset is benign to the DAC and does not affect most applications because the DAC output is ac-coupled through dc blocking capacitors.

INTERPOLATION FILTERS

The main digital path contains five half-band interpolation filters, plus a final half-band interpolation filter that is used in 2× NRZ mode. The filters are cascaded as shown in Figure 107.

The first pair of filters is a 2× (HB2) or 3× (HB3) filter. Each of these filters has two options for bandwidth, 80% or 90%. The 80% filters are lower power than the 90%. The filters default to the lower power 80% bandwidth. To select the filter bandwidth as 90%, program the FILT_BW bit in the DATAPATH_CFG register to 1 (Register 0x111, Bit 4 = 0b1).

Following the first pair of filters is a series of 2× half-band filters, each of which halves the usable bandwidth of the previous one. HB4 has 45%, HB5 has 22.5%, and HB6 has 11.25% of the f_{DATA} bandwidth.

The final half-band filter, FIR85, is used in the 2× NRZ mode. It is clocked at the 2 × f_{DAC} rate and has a usable bandwidth of 45% of the f_{DAC} rate. The FIR85 filter is a complex filter, and therefore the bandwidth is centered at 0 Hz. The FIR85 filter is used in conjunction with the complex interpolation modes to push the DAC update rate higher and move images further from the desired signal.

Table 33 shows how to select each available interpolation mode, their usable bandwidths, and their maximum data rates. Calculate the available signal bandwidth as the interpolator filter bandwidth, BW_{FILT}, multiplied by f_{DAC}/InterpolationFactor, as follows:

$$BW_{\text{SIGNAL}} = BW_{\text{FILT}} \times (f_{\text{DAC}} / \text{InterpolationFactor})$$

Filter Performance

The interpolation filters interpolate between existing data in such a way that they minimize changes in the incoming data while suppressing the creation of interpolation images. This datapath is shown for each filter in Figure 108.

The usable bandwidth (as shown in Table 33) is defined as the frequency band over which the filters have a pass-band ripple of less than ± 0.001 dB and an image rejection of greater than 85 dB. A conceptual drawing that shows the relative bandwidth of each of the filters is shown in Figure 108. The maximum pass band amplitude of all filters is the same; they are different in the illustration to improve understanding.

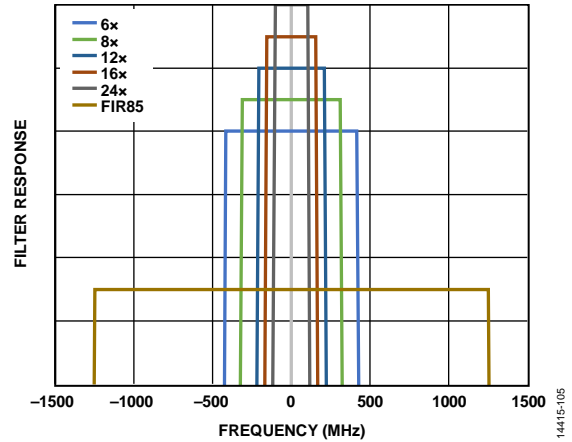

Figure 108. All Band Responses of Interpolation Filters

Filter Performance Beyond Specified Bandwidth

Some of the interpolation filters are specified to $0.4 \times f_{DATA}$ (with a pass band). The filters can be used slightly beyond this ratio at the expense of increased pass-band ripple and decreased interpolation image rejection.

Table 33. Interpolation Modes and Usable Bandwidth

Interpolation Mode	INTERP_MODE, Register 0x110, Bits[3:0]	Available Signal Bandwidth (BW) ¹	Maximum f_{DATA} (MHz)
6x	0x04	$BW \times f_{DATA}/2$	$f_{DAC}/6$
8x	0x05	$BW \times f_{DATA}/2$	$f_{DAC}/8$
12x	0x06	$BW \times f_{DATA}/2$	$f_{DAC}/12$
16x	0x07	$BW \times f_{DATA}/2$	$f_{DAC}/16$
24x	0x08	$BW \times f_{DATA}/2$	$f_{DAC}/24$
2x NRZ (Register 0x111, Bit 0 = 1)	Any combination ²	$0.45 \times f_{DAC}$ ³	f_{DAC} (real) or $f_{DAC}/2$ (complex) ³

¹ The data rate (f_{DATA}) for all interpolator modes is a complex data rate, meaning each of I data and Q data run at that rate. Available signal bandwidth is the data rate multiplied by the bandwidth of the initial 2x or 3x interpolator filters, which can be set to $BW = 80\%$ or $BW = 90\%$. This bandwidth is centered at 0 Hz.

² The 2x NRZ filter, FIR85, can be used with any of the interpolator combinations.

³ The bandwidth of the FIR85 filter is centered at 0 Hz.

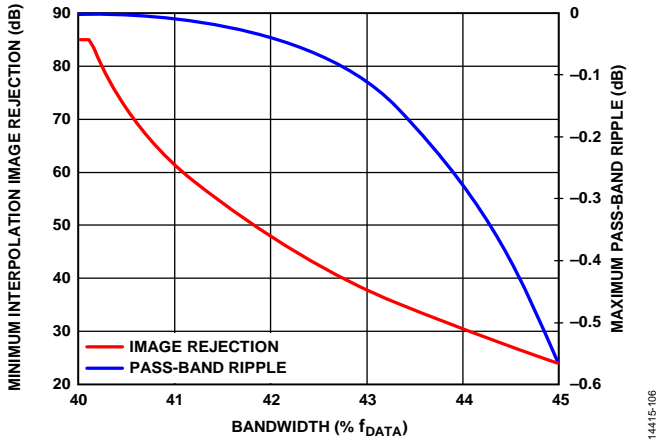

Figure 109. Interpolation Filter Performance Beyond Specified Bandwidth for the 80% Filters

Figure 109 shows the performance of the interpolation filters beyond $0.4 \times f_{DATA}$. The ripple increases much slower than the image rejection decreases. This means that if the application can tolerate degraded image rejection from the interpolation filters, more bandwidth can be used.

Most of the filters are specified to $0.45 \times f_{DATA}$ (with pass band). Figure 110 to Figure 117 show the filter response for each of the interpolator filters on the AD9163.

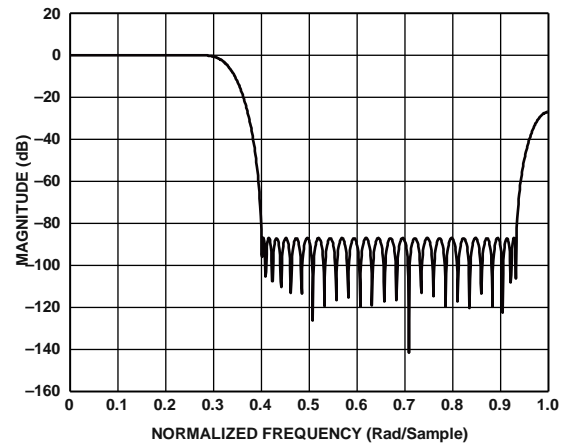

Figure 112. 3x Third-Band 80% Filter Response

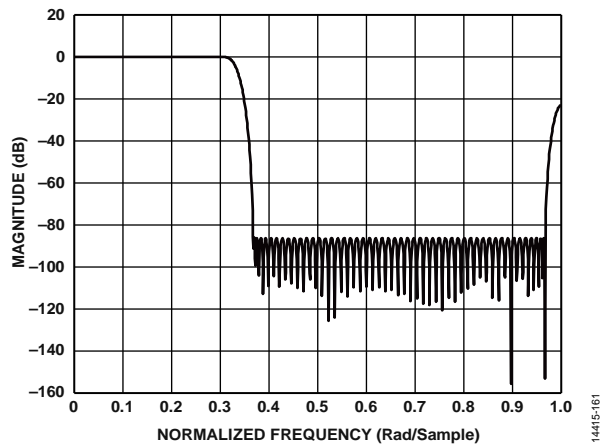

Figure 113. 3x Third-Band 90% Filter Response

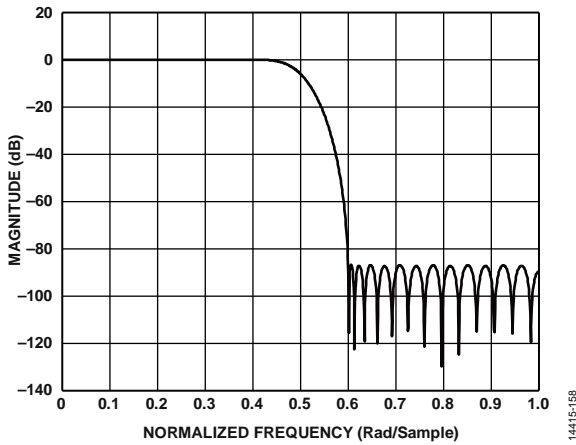

Figure 110. First 2x Half-Band 80% Filter Response

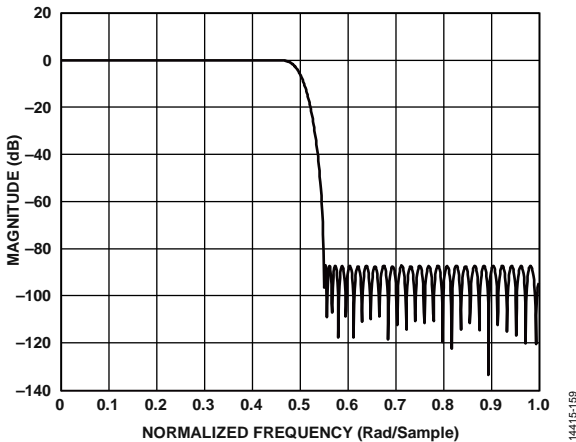

Figure 111. First 2x Half-Band 90% Filter Response

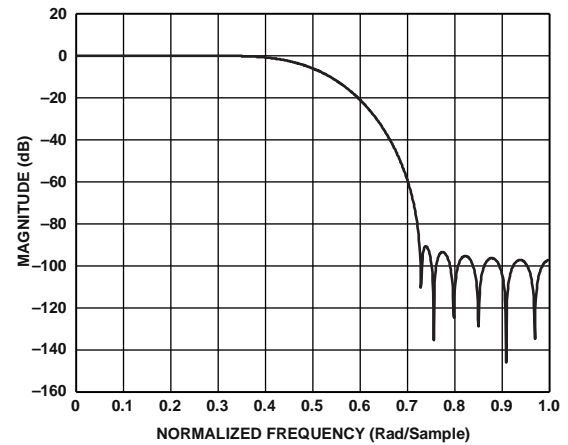

Figure 114. Second 2x Half-Band 45% Filter Response

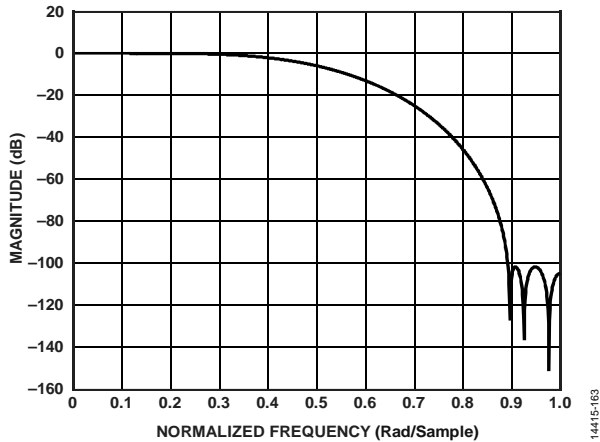

Figure 115. Third 2x Half-Band 22.5% Filter Response

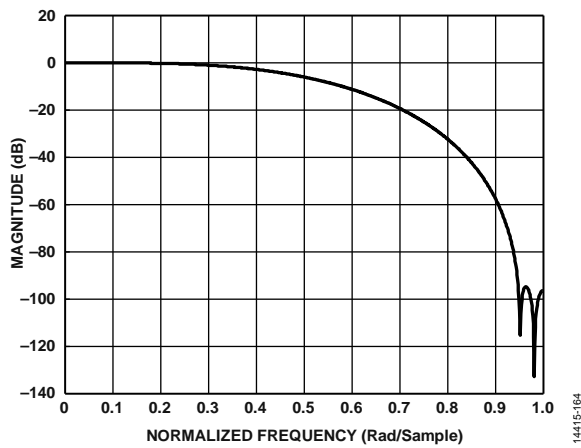

Figure 116. Fourth 2x Half-Band 11.25% Filter Response

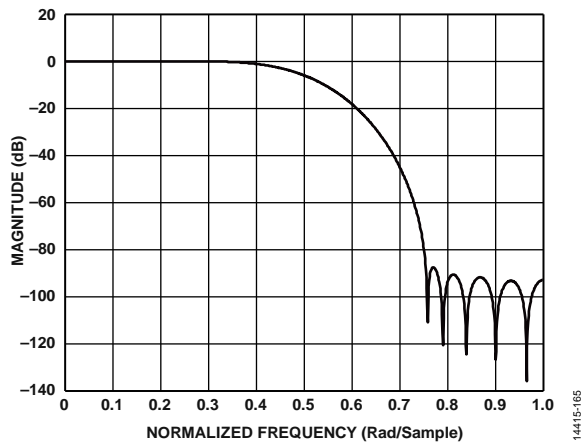

Figure 117. FIR85 2x Half-Band 45% Filter Response

DIGITAL MODULATION

The AD9163 has digital modulation features to modulate the baseband quadrature signal to the desired DAC output frequency.

The AD9163 is equipped with several NCO modes. The default NCO is a 48-bit, integer NCO. The A/B ratio of the dual modulus NCO allows the output frequency to be synthesized with very fine precision. NCO mode is selected as shown in Table 34.

Table 34. Modulation Mode Selection

Modulation Mode	Modulation Type	
	Register 0x111, Bit 6	Register 0x111, Bit 2
None	0b0	0b0
48-Bit Integer NCO	0b1	0b0
48-Bit Dual Modulus NCO	0b1	0b1

48-Bit Dual Modulus NCO

This modulation mode uses an NCO, a phase shifter, and a complex modulator to modulate the signal by a programmable carrier signal as shown in Figure 118. This configuration allows output signals to be placed anywhere in the output spectrum with very fine frequency resolution.

The NCO produces a quadrature carrier to translate the input signal to a new center frequency. A quadrature carrier is a pair of sinusoidal waveforms of the same frequency, offset 90° from each other. The frequency of the quadrature carrier is set via a FTW. The quadrature carrier is mixed with the I and Q data and then summed into the I and Q datapaths, as shown in Figure 118.

Integer NCO Mode

The main 48-bit NCO can be used as an integer NCO by using the following formula to create the frequency tuning word (FTW):

$$-f_{DAC}/2 \leq f_{CARRIER} < +f_{DAC}/2$$

$$FTW = (f_{CARRIER}/f_{DAC}) \times 2^{48}$$

where FTW is a 48-bit, two's complement number.

When in 2x NRZ mode (FIR85 enabled with Register 0x111, Bit 0 = 1), the frequency tuning word is calculated as

$$0 \leq f_{CARRIER} < f_{DAC}$$

$$FTW = (f_{CARRIER}/f_{DAC}) \times 2^{48}$$

where FTW is a 48-bit binary number.

This method of calculation causes $f_{CARRIER}$ values in the second Nyquist zone to appear to move to $f_{DAC} - f_{CARRIER}$ when flipping the FIR85 enable bit and not changing the FTW to account for the change in number format.

The intended effect is that a sweep of the NCO from 0 Hz to $f_{DAC} - f_{DAC}/2^{48}$ appears seamless when the FIR85 enable bit is set to Register 0x111, Bit 0 = 0b1 prior to $f_{CARRIER}/f_{DAC} = 0.5$. As can be seen from examination, the FTWs from 0 to less than $f_{DAC}/2$ mean the same in either case, but they mean different $f_{CARRIER}$ values from $f_{DAC}/2$ to $f_{DAC} - f_{DAC}/2^{48}$. This effect must be considered when constructing FTW values and using the $2 \times$ NRZ mode.

The frequency tuning word is set as shown in Table 35.

Table 35. NCO FTW Registers

Address	Value	Description
0x114	FTW[7:0]	8 LSBs of FTW
0x115	FTW[15:8]	Next 8 bits of FTW
0x116	FTW[23:16]	Next 8 bits of FTW
0x117	FTW[31:24]	Next 8 bits of FTW
0x118	FTW[39:32]	Next 8 bits of FTW
0x119	FTW[47:40]	8 MSBs of FTW

Unlike other registers, the FTW registers are not updated immediately upon writing. Instead, the FTW registers update on the rising edge of FTW_LOAD_REQ (Register 0x113, Bit 0). After an update request, FTW_LOAD_ACK (Register 0x113, Bit 1) must be high to acknowledge that the FTW has updated.

The SEL_SIDE BAND bit (Register 0x111, Bit 1 = 0b1) is a convenience bit that can be set to use the lower sideband modulation result, which is equivalent to flipping the sign of the FTW.

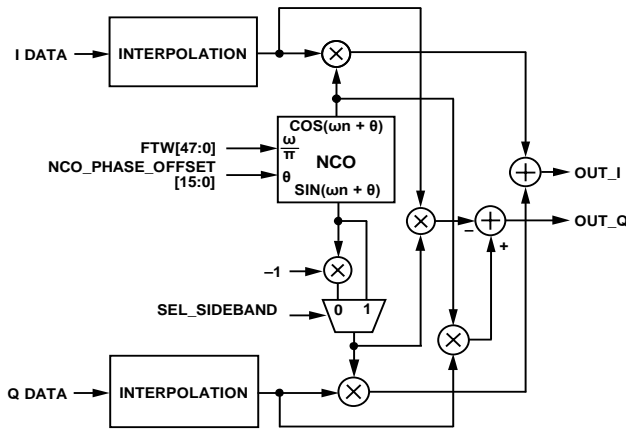

Figure 118. NCO Modulator Block Diagram

Modulus NCO Mode

The main 48-bit NCO can also be used in a dual modulus mode to create fractional frequencies beyond the 48-bit accuracy. The modulus mode is enabled by programming the MODULUS_EN bit in the DATAPATH_CFG register to 1 (Register 0x111, Bit 2 = 0b1).

The frequency ratio for the programmable modulus direct digital synthesis (DDS) is very similar to that of the typical accumulator-based DDS. The only difference is that N is not required to be a power of two for the programmable modulus, but can be an arbitrary integer. In practice, hardware constraints place limits on the range of values for N. As a result, the modulus extends the use of the NCO to applications that

require exact rational frequency synthesis. The underlying function of the programmable modulus technique is to alter the accumulator modulus.

Implementation of the programmable modulus function within the AD9163 is such that the fraction, M/N, is expressible per Equation 1. Note that the form of the equation implies a compound frequency tuning word with X representing the integer part and A/B representing the fractional part.

$$\frac{f_{CARRIER}}{f_{DAC}} = \frac{M}{N} = \frac{X + \frac{A}{B}}{2^{48}} \tag{1}$$

where:

X is programmed in Register 0x114 to Register 0x119.

A is programmed in Register 0x12A to Register 0x12F.

B is programmed in Register 0x124 to Register 0x129.

Programmable Modulus Example

Consider the case in which $f_{DAC} = 2500$ MHz and the desired value of $f_{CARRIER}$ is 250 MHz. This scenario synthesizes an output frequency that is not a power of two submultiple of the sample rate, namely $f_{CARRIER} = (1/10) f_{DAC}$, which is not possible with a typical accumulator-based DDS. The frequency ratio, $f_{CARRIER}/f_{DAC}$, leads directly to M and N, which are determined by reducing the fraction (250,000,000/2,500,000,000) to its lowest terms, that is,

$$M/N = 250,000,000/2,500,000,000 = 1/10$$

Therefore, M = 1 and N = 10.

After calculation, X = 28147497671065, A = 3, and B = 5.

Programming these values into the registers for X, A, and B (X is programmed in Register 0x114 to Register 0x119, B is programmed in Register 0x124 to Register 0x129, and A is programmed in Register 0x12A to Register 0x12F) causes the NCO to produce an output frequency of exactly 250 MHz given a 2500 MHz sampling clock. For more details, refer to the AN-953 Application Note on the Analog Devices, Inc., website.

NCO Reset

Resetting the NCO can be useful when determining the start time and phase of the NCO. The NCO can be reset by several different methods, including a SPI write, using the TX_ENABLE pin, or by the SYSREF± signal. Due to internal timing variations from device to device, these methods achieve an accuracy of ±6 DAC clock cycles.

Program Register 0x800, Bits[7:6] to 0b01 to set the NCO in phase discontinuous switching mode via a write to the SPI port. Then, any time the frequency tuning word is updated, the NCO phase accumulator resets and the NCO begins counting at the new FTW.

Changing the NCO Frequency

In the 48-bit NCO, the mode of updating the frequency tuning word can be changed from requiring a write to the FTW_LOAD_REQ bit (Register 0x113, Bit 0) to an automatic update mode. In the automatic update mode, the FTW is updated as soon as the chosen FTW word is written.

To set the automatic FTW update mode, write the appropriate word to the FTW_REQ_MODE bits (Register 0x113, Bits[6:4]), choosing the particular FTW word that causes the automatic update. For example, if relatively coarse frequency steps are needed, it may be sufficient to write a single word to the MSB byte of the FTW, and therefore the FTW_REQ_MODE bits can be programmed to 110 (Register 0x113, Bits[6:4] = 0b110). Then, each time the most significant byte, FTW5, is written, the NCO FTW is automatically updated.

The FTW_REQ_MODE bits can be configured to use any of the FTW words as the automatic update trigger word. This configuration provides convenience when choosing the order in which to program the FTW registers.

The speed of the SPI port write function is guaranteed, and is a minimum of 100 MHz (see Table 4). Thus, the NCO FTW can be updated in as little as 240 ns with a one register write in automatic update mode.

The manner in which the NCO transitions to the new frequency is determined by the frequency change mode selection.

The NCO supports several modes of changing frequency: phase continuous or phase discontinuous. The modes are given in Table 36.

Table 36. NCO Frequency Change Mode

Register 0x800, Bits[7:6]	Description
0b00	Phase continuous switch
0b01	Phase discontinuous switch (reset NCO accumulator)

In phase continuous switching, the frequency tuning word of the NCO is updated and the phase accumulator continues to accumulate to the new frequency. In phase discontinuous mode, the FTW of the NCO is updated and the phase accumulator is reset, making an instantaneous jump to the new frequency.

INVERSE SINC

The AD9163 provides a digital inverse sinc filter to compensate the DAC roll-off over frequency. The filter is enabled by setting the INVSINC_EN bit (Register 0x111, Bit 7) and is disabled by default.

The inverse sinc (sinc^{-1}) filter is a seven-tap FIR filter. Figure 119 shows the frequency response of $\sin(x)/x$ roll-off, the inverse sinc filter, and the composite response. The composite response has less than ± 0.05 dB pass-band ripple up to a frequency of $0.4 \times f_{\text{DACCLK}}$. When $2 \times \text{NRZ}$ mode is enabled, the inverse sinc filter operates to $0.4 \times f_{2 \times \text{DACCLK}}$.

To provide the necessary peaking at the upper end of the pass band, the inverse sinc filter shown has an intrinsic insertion loss of about 3.8 dB.

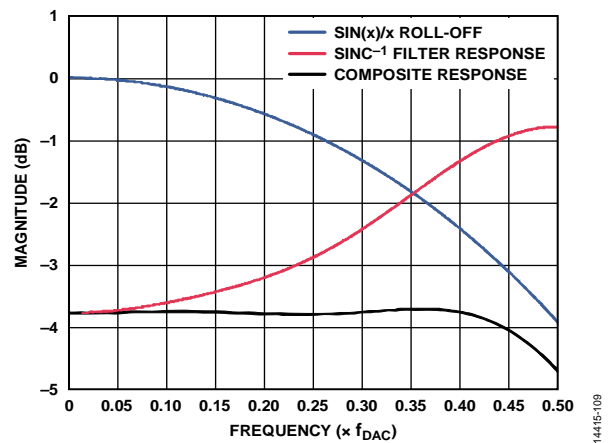

Figure 119. Responses of $\sin(x)/x$ Roll-Off, the Sinc^{-1} Filter, and the Composite of the Two

DOWNSTREAM PROTECTION

The AD9163 has several features designed to protect the power amplifier (PA) of the system, as well as other downstream blocks. They consist of a control signal from the LMFC sync logic and a transmit enable function. The protection mechanism in each case is the blanking of data that is passed to the DAC decoder. The differences lie in the location in the datapath and slight variations of functionality.

The JESD204B serial link has several flags and quality measures to indicate the serial link is up and running error free. If any of these measures flags an issue, a signal from the LMFC sync logic is sent to a mux that stops data from flowing to the DAC decoder and replaces it with 0s.

There are several transmit enable features, including a TX_ENABLE register that can be used to squelch data at several points in the datapath or configure the TX_ENABLE pin to do likewise.

Transmit Enable

The transmit enable feature can be configured either as a SPI controlled function or a pin controlled function. It can be used for several different purposes. The SPI controlled function has less accurate timing due to its reliance on a microcontroller to program it; therefore, it is typically used as a preventative measure at power-up or when configuring the device.

The SPI controlled TX_ENABLE function can be used to zero the input to the digital datapath or to zero the output from the digital datapath, as shown in Figure 120. If the input to the digital datapath is zeroed, any filtering that is selected filters the 0 signal, causing a gradual ramp-down of energy in the digital datapath. If the digital datapath is bypassed, as in $1 \times$ mode, the data at the input to the DAC immediately drops to zero.

The TX_ENABLE pin can be used for more accurate timing when enabling or disabling the DAC output. The effect of the TX_ENABLE pin can be configured by the same TX_ENABLE register (Register 0x03F) as is used for the SPI controlled functions, and it can be made to have the same effects as the SPI controlled function, namely to zero the input to the digital datapath or to zero the output from the digital datapath. In addition, the TX_ENABLE pin can also be configured to ramp down (or up) the full-scale current of the DAC. The ramp down reduces the output power of the DAC by about 20 dB from full scale to the minimum output current.

The TX_ENABLE pin can also be programmed to reset the NCO phase accumulator. See Table 37 for a description of the settings available for the TX_ENABLE function.

Table 37. TX_ENABLE Settings

Register 0x03F	Setting	Description
Bit 7	0	SPI control: zero data to the DAC
	1	SPI control: allow data to pass to the DAC
Bit 6	0	SPI control: zero data at input to the datapath
	1	SPI control: allow data to enter the datapath
Bits[5:4]	N/A ¹	Reserved
Bit 3	0	Use SPI writes to reset the NCO ²
	1	Use TX_ENABLE to reset the NCO
Bit 2	0	Use SPI control to zero data to the DAC
	1	Use TX_ENABLE pin to zero data to the DAC
Bit 1	0	Use SPI control to zero data at the input to the datapath
	1	Use TX_ENABLE pin to zero data at input to the datapath
Bit 0	0	Use SPI registers to control the full-scale current
	1	Use TX_ENABLE pin to control the full-scale current

¹ N/A means not applicable.

² Use SPI writes to reset the NCO if resetting the NCO is desired. Register 0x800, Bits[7:6] determine whether the NCO is reset. See Table 36 for more details.

DATAPATH PRBS

The datapath PRBS can verify the AD9163 datapath receives and correctly decodes data. The datapath PRBS verifies the JESD204B parameters of the transmitter and receiver match, the lanes of the receiver are mapped appropriately, the lanes are appropriately inverted, and, if necessary, the start-up routine is correctly implemented.

To run the datapath PRBS test, complete the following steps:

1. Set up the device in the desired operating mode using the start-up sequence.
2. Send PRBS7 or PRBS15 data.
3. Write Register 0x14, Bit 2 = 0 for PRBS7 or 1 for PRBS15.
4. Write Register 0x14B, Bits[1:0] = 0b11 to enable and reset the PRBS test.
5. Write Register 0x14B, Bits[1:0] = 0b01 to enable the PRBS test and release reset.
6. Wait 500 ms.
7. Check the status of the PRBS by checking the IRQ for the I and Q path PRBS as described in the Datapath PRBS IRQ section.
8. Read Register 0x14B, Bits [7:6]. Bit 6 is 0 if the I channel has any errors. Bit 7 is 0 if the Q channel has any errors.
9. Read Register 0x14C to read the error count for the I channel.
10. Read Register 0x14D to read the error count for the Q channel. The PRBS processes 32 bits at a time, and compares the 32 new bits to the previous set of 32 bits. It detects and reports only 1 error in every group of 32 bits; therefore, the error count partly depends on when the errors are seen.

For example, see the following sequence:

- Bits: 32 good, 31 good, 1 bad; 32 good [2 errors]
- Bits: 32 good, 22 good, 10 bad; 32 good [2 errors]
- Bits: 32 good, 31 good, 1 bad; 31 good, 1 bad; 32 good [3 errors]

DATAPATH PRBS IRQ

The PRBS fail signals for the I and Q path are available as IRQ events. Use Register 0x020, Bits [1:0] to enable the fail signals, and then use Register 0x024, Bits [1:0] to read back the status and reset the IRQ signals. See the Interrupt Request Operation section for more information.

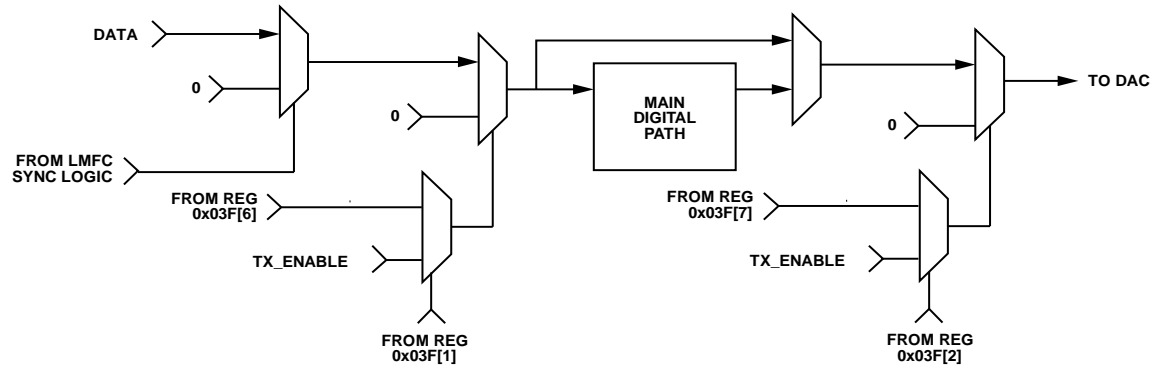

Figure 120. Downstream Protection Block Diagram

14415-110

INTERRUPT REQUEST OPERATION

The AD9163 provides an interrupt request output signal ($\overline{\text{IRQ}}$) on Ball G4 that can be used to notify an external host processor of significant device events. On assertion of the interrupt, query the device to determine the precise event that occurred. The $\overline{\text{IRQ}}$ pin is an open-drain, active low output. Pull the $\overline{\text{IRQ}}$ pin high, external to the device. This pin can be tied to the interrupt pins of other devices with open-drain outputs to wire; OR these pins together.

Figure 121 shows a simplified block diagram of how the $\overline{\text{IRQ}}$ blocks work. If IRQ_EN is low, the INTERRUPT_SOURCE signal is set to 0. If IRQ_EN is high, any rising edge of EVENT causes the INTERRUPT_SOURCE signal to be set high. If any INTERRUPT_SOURCE signal is high, the $\overline{\text{IRQ}}$ pin is pulled low. INTERRUPT_SOURCE can be reset to 0 by either an IRQ_RESET signal or a DEVICE_RESET signal.

Depending on the STATUS_MODE signal, the EVENT_STATUS bit reads back an event signal or INTERRUPT_SOURCE signal. The AD9163 has several interrupt register blocks ($\overline{\text{IRQ}}$) that can monitor up to 75 events (depending on device configuration). Certain details vary by $\overline{\text{IRQ}}$ register block as described in Table 38. Table 39 shows the source registers of the IRQ_EN , IRQ_RESET , and STATUS_MODE signals in Figure 121, as well as the address where EVENT_STATUS is read back.

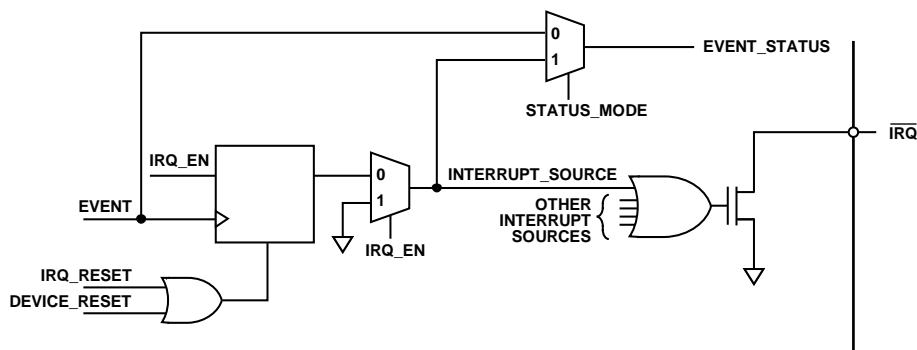

Figure 121. Simplified Schematic of $\overline{\text{IRQ}}$ Circuitry

Table 38. $\overline{\text{IRQ}}$ Register Block Details

Register Block	Event Reported	EVENT_STATUS
0x020, 0x024	Per chip	INTERRUPT_SOURCE if $\overline{\text{IRQ}}$ is enabled; if not, it is the event signal
0x4B8 to 0x4BB; 0x470 to 0x473	Per link and lane	INTERRUPT_SOURCE if $\overline{\text{IRQ}}$ is enabled; if not, 0

INTERRUPT SERVICE ROUTINE

Interrupt request management starts by selecting the set of event flags that require host intervention or monitoring. Enable the events that require host action so that the host is notified when they occur. For events requiring host intervention upon $\overline{\text{IRQ}}$ activation, run the following routine to clear an interrupt request:

1. Read the status of the event flag bits that are being monitored.
2. Disable the interrupt by writing 0 to IRQ_EN .
3. Read the event source.
4. Perform any actions that may be required to clear the cause of the event. In many cases, no specific actions may be required.
5. Verify that the event source is functioning as expected.
6. Clear the interrupt by writing 1 to IRQ_RESET .
7. Enable the interrupt by writing 1 to IRQ_EN .

Table 39. $\overline{\text{IRQ}}$ Register Block Address of $\overline{\text{IRQ}}$ Signal Details

Register Block	Address of $\overline{\text{IRQ}}$ Signals ¹			
	IRQ_EN	IRQ_RESET	STATUS_MODE ²	EVENT_STATUS
0x020, 0x024	0x020; R/W per chip	0x024; W per chip	$\text{STATUS_MODE} = \text{IRQ_EN}$	0x024; R per chip
0x4B8 to 0x4BB	0x4B8, 0x4B9; W per error type	0x4BA, 0x4BB; W per error type	N/A, $\text{STATUS_MODE} = 1$	0x4BA, 0x4BB; R per chip
0x470 to 0x473	0x470 to 0x473; W per error type	0x470 to 0x473; W per link	N/A, $\text{STATUS_MODE} = 1$	0x470 to 0x473; R per link

¹ R is read; W is write; and R/W is read/write.

² N/A means not applicable.

APPLICATIONS INFORMATION

HARDWARE CONSIDERATIONS

Power Supply Recommendations

All the AD9163 supply domains must remain as noise free as possible for the best operation. Power supply noise has a frequency component that affects performance, and is specified in volts rms terms.

An LC filter on the output of the power supply is recommended to attenuate the noise, and must be placed as close to the AD9163 as possible. The VDD12_CLK supply is the most noise sensitive supply on the device, followed by the VDD25_DAC and VNEG_N1P2 supplies, which are the DAC output rails. It is highly recommended that the VDD12_CLK be supplied by itself with an ultralow noise regulator such as the ADM7154 or ADP1761 to achieve the best phase noise performance possible. Noisier regulators impose phase noise onto the DAC output.

The VDD12A supply can be connected to the digital DVDD supply with a separate filter network. All of the SERDES 1.2 V supplies can be connected to one regulator with separate filter networks. The IOVDD supply can be connected to the VDD25_DAC supply with a separate filter network, or can be powered from a system controller (for example, a microcontroller), 1.8 V to 3.3 V supply. The power supply sequencing requirement must be met; therefore, a switch or other solution must be used when connected to the IOVDD supply with VDD25_DAC.

Take note of the maximum power consumption numbers given in Table 3 to ensure the power supply design can tolerate temperature and IC process variation extremes. The amount of current drawn is dependent on the chosen use cases, and specifications are provided for several use cases to illustrate examples and contributions from individual blocks, and to assist in calculating the maximum required current per supply.

Another consideration for the power supply design is peak current handling capability. The AD9163 draws more current in the main digital supply when synthesizing a signal with significant amplitude variations, such as a modulated signal, as compared to when in idle mode or synthesizing a dc signal. Therefore, the power supply must be able to supply current quickly to accommodate burst signals such as GSM, TDMA, or other signals that have an on/off time domain response. Because the amount of current variation depends on the signals used, it is best to perform lab testing first to establish ranges. A typical difference can be several hundred milliamperes.

Power Sequencing

The AD9163 requires power sequencing to avoid damage to the DAC. A board design with the AD9163 must include a power sequencer chip, such as the ADM1184, to ensure that the domains power up in the correct order. The ADM1184 monitors the level of power domains upon power-up. It sends an enable signal to the next grouping of power domains. When all power domains are powered up, a power-good signal is sent to the system controller to indicate all power supplies are powered up.

The IOVDD, VDD12A, VDD12_CLK, and DVDD domains must be powered up first. Then, the VNEG_N1P2, VDD_1P2, PLL_CLK_VDD12, DVDD_1P2, and SYNC_VDD_3P3 can be powered up. The VDD25_DAC domain must be powered up last. There is no requirement for a power-down sequence.

Power and Ground Planes

Solid ground planes are recommended to avoid ground loops and to provide a solid, uninterrupted ground reference for the high speed transmission lines that require controlled impedances. It is recommended that power planes be stacked between ground layers for high frequency filtering. Doing so adds extra filtering and isolation between power supply domains in addition to the decoupling capacitors.

Do not use segmented power planes as a reference for controlled impedances unless the entire length of the controlled impedance trace traverses across only a single segmented plane. These and additional guidelines for the topology of high speed transmission lines are described in the JESD204B Serial Interface Inputs (SERDIN0± to SERDIN7±) section.

For some applications, where highest performance and higher output frequencies are required, the choice of PCB materials significantly impacts results. For example, materials such as polyimide or materials from the Rogers Corporation can be used, for example, to improve tolerance to high temperatures and improve performance. Rogers 4350 material is used for the top three layers in some of the evaluation board designs: between the top signal layer and the ground layer below it, between the ground layer and an internal signal layer, and between that signal layer and another ground layer.

JESD204B Serial Interface Inputs (SERDIN0± to SERDIN7±)

When considering the layout of the JESD204B serial interface transmission lines, there are many factors to consider to maintain optimal link performance. Among these factors are insertion loss, return loss, signal skew, and the topology of the differential traces.

Insertion Loss

The JESD204B specification limits the amount of insertion loss allowed in the transmission channel (see Figure 93). The AD9163 equalization circuitry allows significantly more loss in the channel than is required by the JESD204B specification. It is still important that the designer of the PCB minimize the amount of insertion loss by adhering to the following guidelines:

- Keep the differential traces short by placing the AD9163 as near the transmitting logic device as possible and routing the trace as directly as possible between the devices.
- Route the differential pairs on a single plane using a solid ground plane as a reference. It is recommended to route the SERDES lanes on the same layer as the AD9163 to avoid vias being used in the SERDES lanes.
- Use a PCB material with a low dielectric constant (<4) to minimize loss, if possible.

When choosing between the stripline and microstrip techniques, keep in mind the following considerations: stripline has less loss (see Figure 95 and Figure 96) and emits less EMI, but requires the use of vias that can add complexity to the task of controlling the impedance; whereas microstrip is easier to implement (if the component placement and density allow routing on the top layer) and eases the task of controlling the impedance.

If using the top layer of the PCB is problematic or the advantages of stripline are desirable, follow these recommendations:

- Minimize the number of vias.
- If possible, use blind vias to eliminate via stub effects and use microvias to minimize via inductance.
- If using standard vias, use the maximum via length to minimize the stub size. For example, on an 8-layer board, use Layer 7 for the stripline pair (see Figure 122).
- For each via pair, place a pair of ground vias adjacent to them to minimize the impedance discontinuity (see Figure 122).

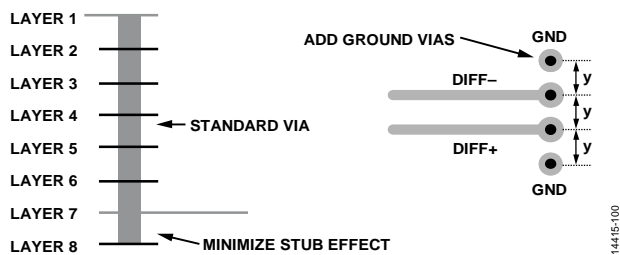

Figure 122. Minimizing Stub Effect and Adding Ground Vias for Differential Stripline Traces

Return Loss

The JESD204B specification limits the amount of return loss allowed in a converter device and a logic device, but does not specify return loss for the channel. However, every effort must be made to maintain a continuous impedance on the transmission line between the transmitting logic device and the AD9163. Minimizing the use of vias, or eliminating them all together, reduces one of the primary sources for impedance mismatches

on a transmission line (see the Insertion Loss section). Maintain a solid reference beneath (for microstrip) or above and below (for stripline) the differential traces to ensure continuity in the impedance of the transmission line. If the stripline technique is used, follow the guidelines listed in the Insertion Loss section to minimize impedance mismatches and stub effects.

Another primary source for impedance mismatch is at either end of the transmission line, where care must be taken to match the impedance of the termination to that of the transmission line. The AD9163 handles this internally with a calibrated termination scheme for the receiving end of the line. See the Interface Power-Up and Input Termination section for details on this circuit and the calibration routine.

Signal Skew

There are many sources for signal skew, but the two sources to consider when laying out a PCB are interconnect skew within a single JESD204B link and skew between multiple JESD204B links. In each case, keeping the channel lengths matched to within 12.5 mm is adequate for operating the JESD204B link at speeds of up to 12.5 Gbps. This amount of channel length match is equivalent to about 85% UI on the AD9163 evaluation board. Managing the interconnect skew within a single link is fairly straightforward. Managing multiple links across multiple devices is more complex. However, follow the 12.5 mm guideline for length matching. The AD9163 can handle more skew than the 85% UI due to the 6 PCLK buffer in the JESD204B receiver, but matching the channel lengths as close as possible is still recommended.

Topology

Structure the differential SERDINx± pairs to achieve 50 Ω to ground for each half of the pair. Stripline vs. microstrip trade-offs are described in the Insertion Loss section. In either case, it is important to keep these transmission lines separated from potential noise sources such as high speed digital signals and noisy supplies. If using stripline differential traces, route them using a coplanar method, with both traces on the same layer. Although this method does not offer more noise immunity than the broadside routing method (traces routed on adjacent layers), it is easier to route and manufacture so that the impedance continuity is maintained. An illustration of broadside vs. coplanar is shown in Figure 123.

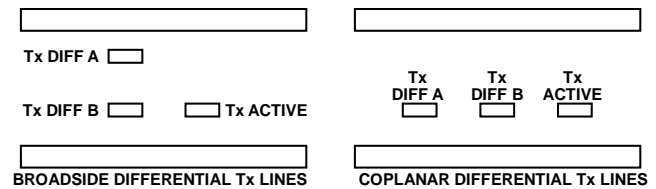

Figure 123. Broadside vs. Coplanar Differential Stripline Routing Techniques

When considering the trace width vs. copper weight and thickness, the speed of the interface must be considered. At multigigabit speeds, the skin effect of the conducting material confines the current flow to the surface. Maximize the surface area of the conductor by making the trace width made wider to reduce the losses. Additionally, loosely couple differential traces to accommodate the wider trace widths. This coupling helps reduce the crosstalk and minimize the impedance mismatch when the traces must separate to accommodate components, vias, connectors, or other routing obstacles. Tightly coupled vs. loosely coupled differential traces are shown in Figure 124.

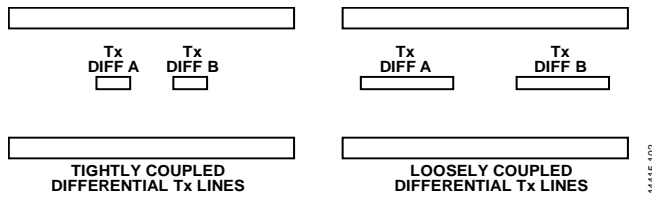

Figure 124. Tightly Coupled vs. Loosely Coupled Differential Traces

AC Coupling Capacitors

The AD9163 requires that the JESD204B input signals be ac-coupled to the source. These capacitors must be 100 nF and placed as close as possible to the transmitting logic device.

To minimize the impedance mismatch at the pads, select the package size of the capacitor so that the pad size on the PCB matches the trace width as closely as possible.

SYNCOUT±, SYSREF±, and CLK± Signals

The SYNCOUT± and SYSREF± signals on the AD9163 is low speed LVDS differential signals. Use controlled impedance traces routed with 100 Ω differential impedance and 50 Ω to ground when routing these signals. As with the SERDIN0± to SERDIN7± data pairs, it is important to keep these signals separated from potential noise sources such as high speed digital signals and noisy supplies.

Separate the SYNCOUT± signal from other noisy signals, because noise on the SYNCOUT± may be interpreted as a request for /K/ characters.

It is important to keep similar trace lengths for the CLK± and SYSREF± signals from the clock source to each of the devices on either end of the JESD204B links (see Figure 125). If using a clock chip that can tightly control the phase of CLK± and SYSREF±, the trace length matching requirements are greatly reduced.

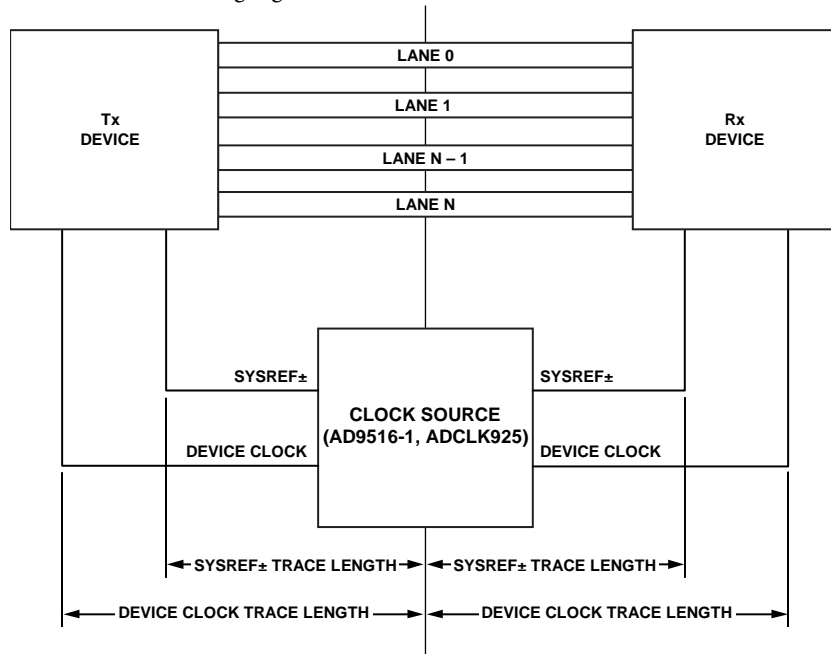

Figure 125. SYSREF± Signal and Device Clock Trace Length

ANALOG INTERFACE CONSIDERATIONS

ANALOG MODES OF OPERATION

The AD9163 uses the quad-switch architecture shown in Figure 126. Only one pair of switches is enabled during a half-clock cycle, thus requiring each pair to be clocked on alternative clock edges. A key benefit of the quad-switch architecture is that it masks the code dependent glitches that occur in the conventional two-switch DAC architecture.

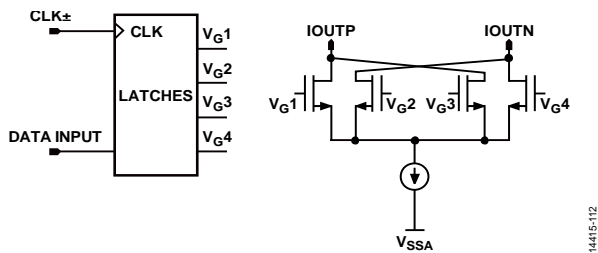

Figure 126. Quad-Switch Architecture

In two-switch architecture, when a switch transition occurs and D_1 and D_2 are in different states, a glitch occurs. However, if D_1 and D_2 happen to be at the same state, the switch transitions and no glitches occur. This code dependent glitching causes an increased amount of distortion in the DAC. In quad-switch architecture (no matter what the codes are), two switches are always transitioning at each half-clock cycle, thus eliminating the code-dependent glitches, but, in the process, creating a constant glitch at $2 \times f_{DAC}$. For this reason, a significant clock spur at $2 \times f_{DAC}$ is evident in the DAC output spectrum.

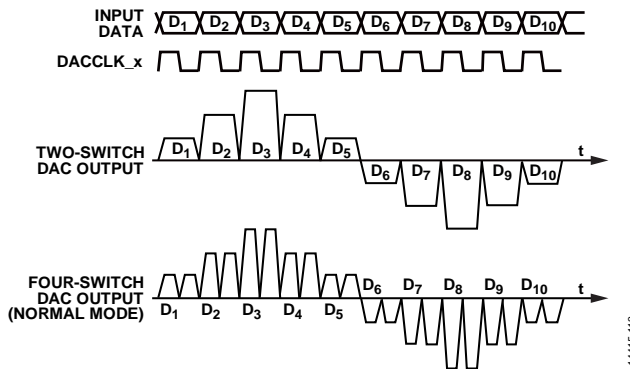

Figure 127. Two-Switch and Quad-Switch DAC Waveforms

As a consequence of the quad-switch architecture enabling updates on each half-clock cycle, it is possible to operate that DAC core at $2 \times$ the DAC clock rate if new data samples are latched into the DAC core on both the rising and falling edges of the DAC clock. This notion serves as the basis when operating the AD9163 in either Mix-Mode or return to zero (RZ) mode. In each case, the DAC core is presented with new data samples on each clock edge: in RZ mode, the rising edge clocks data and the falling edge clocks zero, whereas in Mix-Mode, the falling edge sample is simply the complement of the rising edge sample value.

When Mix-Mode is used, the output is effectively chopped at the DAC sample rate. This chopping has the effect of reducing

the power of the fundamental signal while increasing the power of the images centered around the DAC sample rate, thus improving the dynamic range of these images.

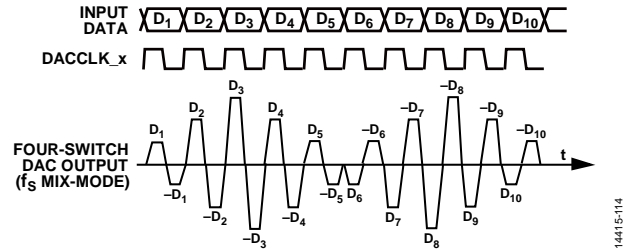

Figure 128. Mix-Mode Waveform

This ability to change modes provides the user the flexibility to place a carrier anywhere in the first three Nyquist zones, depending on the operating mode selected. Switching between baseband and Mix-Mode reshapes the sinc roll-off inherent at the DAC output. In baseband mode, the sinc null appears at f_{DAC} because the same sample latched on the rising clock edge is also latched again on the falling clock edge, thus resulting in the same ubiquitous sinc response of a traditional DAC. In Mix-Mode, the complement sample of the rising edge is latched on the falling edge, therefore pushing the sinc null to $2 \times f_{DAC}$. Figure 129 shows the ideal frequency response of the three modes with the sinc roll-off included.

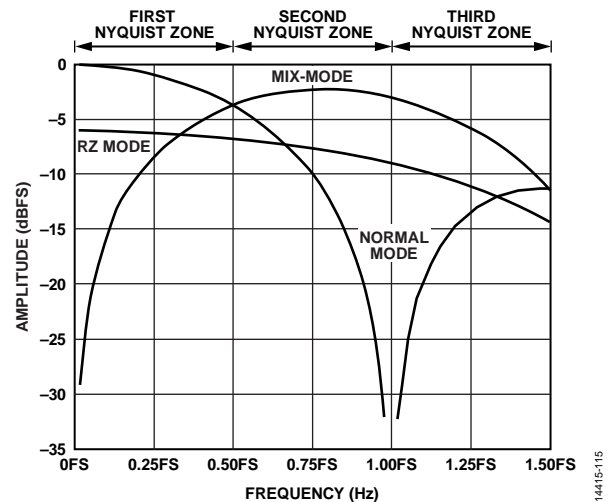

Figure 129. Sinc Roll-Off for NRZ, RZ, and Mix-Mode Operation

The quad-switch can be configured via the SPI (Register 0x152, Bits[1:0]) to operate in either NRZ mode (0b00), RZ mode (0b10), or Mix-Mode (0b01). The AD9163 has an additional frequency response characteristic due to the FIR85 filter. This filter samples data on both the rising and falling edges of the DAC clock, in essence doubling the input clock frequency. As a result, the NRZ (normal) mode roll-off in Figure 129 is extended to $2 \times f_{DAC}$ in Figure 129, and follows the Mix-Mode roll-off due to the zero-order hold at $2 \times$ DAC clock (see Figure 130).

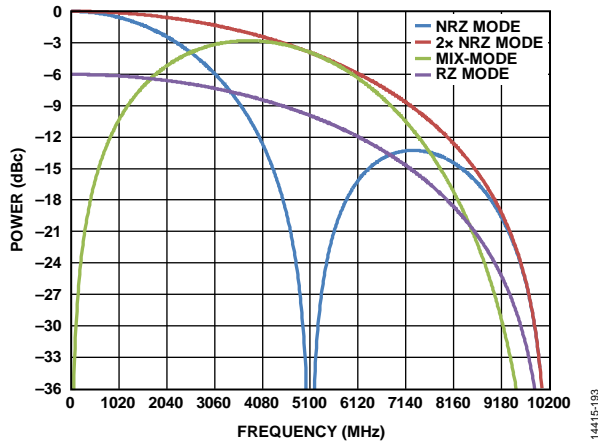

Figure 130. Sinc Roll-Off with 2x NRZ Mode Added, $f_{DAC} = 5.1$ GSPS

CLOCK INPUT

The AD9163 contains a low jitter, differential clock receiver that is capable of interfacing directly to a differential or single-ended clock source. Because the input is self biased with a nominal impedance of 90 Ω, it is recommended that the clock source be ac-coupled to the CLK± input pins. The nominal differential input is 1 V p-p, but the clock receiver can operate with a span that ranges from 250 mV p-p to 2.0 V p-p. Better phase noise performance is achieved with a higher clock input level.

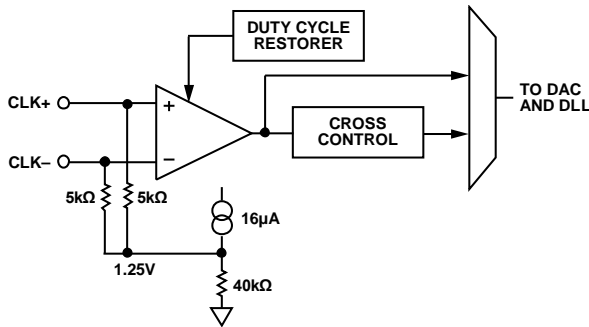

Figure 131. Clock Input

The quality of the clock source, as well as its interface to the AD9163 clock input, directly impacts ac performance. Select the phase noise and spur characteristics of the clock source to meet the target application requirements. Phase noise and spurs at a given frequency offset on the clock source are directly translated to the output signal. It can be shown that the phase noise characteristics of a reconstructed output sine wave are related to the clock source by $20 \times \log_{10}(f_{OUT}/f_{CLK})$ when the DAC clock path contribution is negligible.

Figure 133 shows a clock source based on the ADF4355 low phase noise/jitter PLL. The ADF4355 can provide output frequencies from 54 MHz up to 6.8 GHz.

The clock control registers exist at Address 0x082 through Address 0x084. CLK_DUTY (Register 0x082) can be used to enable duty cycle correction (Bit 7), enable duty cycle offset control (Bit 6), and set the duty cycle offset (Bits[4:0]). The duty cycle offset word is a signed magnitude word, with Bit 4 being

the sign bit (1 is negative) and Bits[3:0] the magnitude. The duty cycle adjusts across a range of approximately ±3%. Recommended settings for this register are listed in the Start-Up Sequence section.

The clock input has a register that adjusts the phase of the CLK+ and CLK- inputs. This register is located at Address 0x07F. The register has a signed magnitude (1 is negative) value that adds capacitance at ~20 fF per step to either the CLK+ or the CLK- input, according to Table 40. The CLK_PHASE_TUNE register can be used to adjust the clock input phase for better DAC image rejection.

Table 40. CLK± Phase Adjust Values

Register 0x07F, Bits[5:0]	Capacitance at CLK+	Capacitance at CLK-
000000	0	0
000001	1 × 20 fF	0
000010	2 × 20 fF	0
...
011111	31 × 20 fF	0
100000	0	0
100001	0	1 × 20 fF
100010	0	2 × 20 fF
...
111111	0	31 × 20 fF

The improvement in performance from making these adjustments depends on the accuracy of the balance of the clock input balun and varies from unit to unit. Thus, if a high level of image rejection is required, it is likely that a per unit calibration is necessary. Performing this calibration can yield significant improvements, as much as 20 dB additional rejection of the image due to imbalance. Figure 132 shows the results of tuning clock phase, duty cycle (left at default in this case), and cross control. The improvement to performance, particularly at higher frequencies, can be as much as 20 dB.

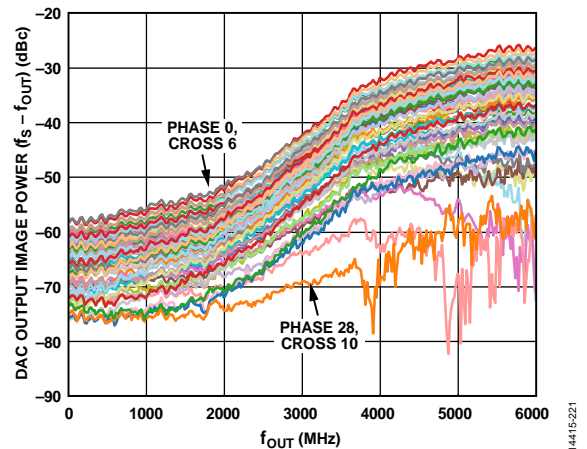

Figure 132. Performance Improvement from Tuning the Clock Input

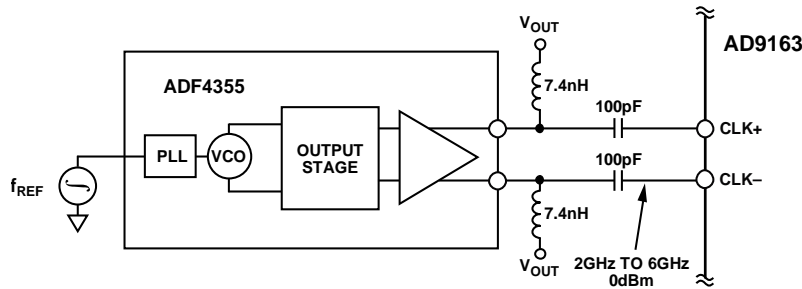

Figure 133. Possible Signal Chain for CLK± Input

SHUFFLE MODE

The spurious performance of the AD9163 can be improved with a feature called shuffle mode. Shuffle mode uses proprietary technology to spread the energy of spurious signals across the DAC output as random noise. Shuffle mode is enabled by programming Register 0x151, Bit 2 = 0b1. Because shuffle is implemented with the MSBs, it is more effective when the DAC is operated with a small amount of digital backoff.

The amount of noise rise caused by shuffle mode is directly related to the power in the affected spurious signals. Because the AD9163 has good spurious performance without shuffle active, the penalty of shuffle mode to the noise spectral density is typically about 1 dB to 3 dB. Shuffle mode reduces spurious performance related to clock and foldback spurs, but does not affect real harmonics of the DAC output. Examples of the effects of shuffle mode are given in the Typical Performance Characteristics section (see Figure 47, Figure 48, Figure 62, Figure 63, and Figure 64).

DLL

The CLK± input goes to a high frequency DLL to ensure robust locking of the DAC sample clock to the input clock. The DLL is configured and enabled as part of the recommended start-up sequence. The DLL control registers are located at Register 0x090 through Register 0x09B. The DLL settings are determined during product characterization and are given in the recommended start-up sequence (see the Start-Up Sequence section). It is not normally necessary to change these values, nor is the product characterization data valid on any settings other than the recommended ones.

VOLTAGE REFERENCE

The AD9163 output current is set by a combination of digital control bits and the ISET reference current, as shown in Figure 134.

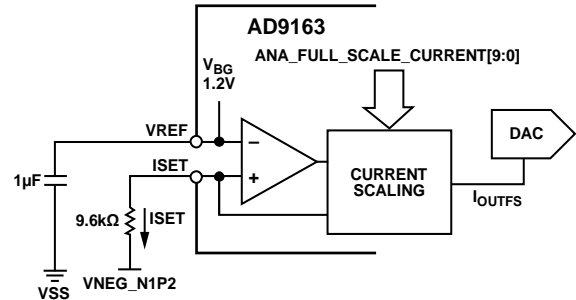

Figure 134. Voltage Reference Circuit

The reference current is obtained by forcing the band gap voltage across an external 9.6 kΩ resistor from ISET (Ball A12) to VNEG_N1P2. The 1.2 V nominal band gap voltage (VREF) generates a 125 μA reference current, ISET, in the 9.6 kΩ resistor, R_{SET}. The maximum full-scale current setting is related to the external resistor by the following equation:

$$I_{OUTFS} = 1.2 \text{ V} / R_{SET} \times 320 \text{ (mA)}$$

Note the following constraints when configuring the voltage reference circuit:

- Both the 9.6 kΩ resistor and 1 μF bypass capacitor are required for proper operation.
- Adjusting the DAC output full-scale current, I_{OUTFS}, from its default setting of 40 mA must be performed digitally.
- The AD9163 is not a multiplying DAC. Modulation of the reference current, ISET, with an ac signal is not supported.
- The band gap voltage appearing at the VREF pin must be buffered for use with an external circuitry because it has a high output impedance.
- An external reference can be used to overdrive the internal reference by connecting it to the VREF pin.

The I_{OUTFS} value can be adjusted digitally over an 8 mA to 40 mA range by the ANA_FULL_SCALE_CURRENT[9:0] bits (Register 0x042, Bits[7:0] and Register 0x041, Bits[1:0]). The following equation relates I_{OUTFS} to the ANA_FULL_SCALE_CURRENT[9:0] bits, which can be set from 0 to 1023.

$$I_{OUTFS} = 32 \text{ mA} \times (\text{ANA_FULL_SCALE_CURRENT}[9:0] / 1023) + 8 \text{ mA}$$

Note that the default value of 0x3FF generates 40 mA full scale, and this value is used for most of the characterization presented in this data sheet, unless noted otherwise.

TEMPERATURE SENSOR

The AD9163 has a band gap temperature sensor for monitoring the temperature changes of the AD9163. The temperature must be calibrated against a known temperature to remove the device to device variation on the band gap circuit that senses the temperature.

To calibrate the temperature, the user must take a reading at a known ambient temperature for a single point calibration of the AD9163 device. The slope for the formula is then calculated as

$$M = (T_{REF} + 190) / ((CODE_REF) / 1000)$$

where:

T_{REF} is the calibrated temperature at which the temperature sensor is read.

$CODE_REF$ is the readback code at the measured temperature, T_{REF} .

To monitor temperature change,

$$T_X = T_{REF} + M \times (CODE_X - CODE_REF) / 1000$$

where:

$CODE_X$ is the readback code at the unknown temperature, T_X .

$CODE_REF$ is the readback code at the calibrated temperature, T_{REF} .

To use the temperature sensor, enable it by setting Register 0x135 to Register 0xA1. The user must write a 1 to Register 0x134, Bit 0 before reading back the die temperature from Register 0x132 (LSB) and Register 0x133 (MSB).

ANALOG OUTPUTS

Equivalent DAC Output and Transfer Function

The AD9163 provides complementary current outputs, OUTPUT+ and OUTPUT-, that sink current from an external load that is referenced to the 2.5 V VDD25_DAC supply. Figure 135 shows an equivalent output circuit for the DAC. Compared to most current output DACs of this type, the outputs of the AD9163 consists of a constant current (I_{FIXED}), and a peak differential ac current, I_{CS} ($I_{CS} = I_{CSP} + I_{CSN}$). These two currents combine to form the I_{INTX} currents shown in Figure 135. The internal currents, I_{INTP} and I_{INTN} , are sent to the output pin and to an input termination resistance equivalent to 100 Ω pulled to the VDD25_DAC supply (R_{INT}). This termination serves to divide the output current based on the external termination resistors that are pulled to VDD25_DAC.

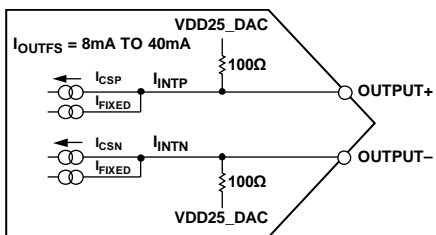

Figure 135. Equivalent DAC Output Circuit

The example shown in Figure 135 can be modeled as a pair of dc current sources that source a current of I_{OUTFS} to each output.

This differential ac current source is used to model the signal (that is, a digital code) dependent nature of the DAC output. The polarity and signal dependency of this ac current source are related to the digital code (F) by the following equation:

$$F (code) = (DACC CODE - 32,768) / 32,768 \tag{2}$$

where:

$$-1 \leq F (code) < +1.$$

$$DACC CODE = 0 \text{ to } 65,535 \text{ (decimal).}$$

The current that is measured at the OUTPUT+ and OUTPUT- outputs is as follows:

$$OUTPUT+ = (I_{FIXED} (mA) + (F \times I_{OUTFS}) / F_{MAX} (mA)) \times (R_{INT} / (R_{INT} + R_{LOAD})) \tag{3}$$

$$OUTPUT- = (I_{FIXED} (mA) + ((F_{MAX} - F) \times I_{OUTFS}) / F_{MAX} (mA)) \times (R_{INT} / (R_{INT} + R_{LOAD}))$$

The I_{FIXED} value is about 3.8 mA. It is important to note that the AD9163 output cannot support dc coupling to the external load, and thus must be ac-coupled through appropriately sized capacitors for the chosen operating frequencies. Figure 136 shows the OUTPUT+ vs. DAC code transfer function when I_{OUTFS} is set to 40 mA.

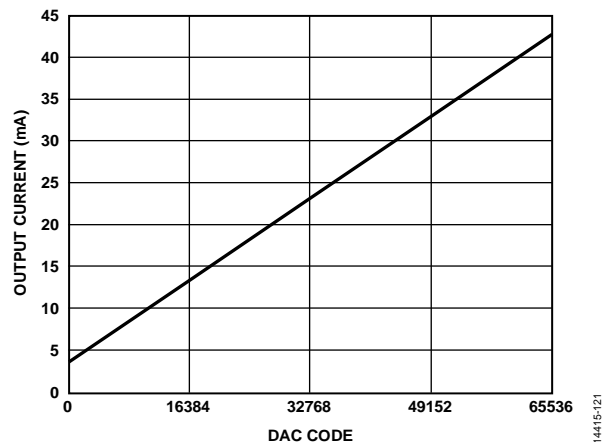

Figure 136. Gain Curve for ANA_FULL_SCALE_CURRENT[9:0] = 1023, DAC Offset = 3.8 mA

Peak DAC Output Power Capability

The maximum peak power capability of a differential current output DAC is dependent on its peak differential ac current, I_{PEAK} , and the equivalent load resistance it sees. In the case of a 1:1 balun with 100 Ω differential source termination, the equivalent load that is seen by the DAC ac current source is 50 Ω . If the AD9163 is programmed for an $I_{OUTFS} = 40$ mA, its ideal peak ac current is 20 mA and its maximum power, delivered to the equivalent load, is $10 \times (R_{INT} / (R_{INT} + R_{LOAD})) = 8$ mW (that is, $P = I^2R$). Because the source and load resistance seen by the 1:1 balun are equal, this power is shared equally. Therefore, the output load receives 4 mW, or 6 dBm maximum power.

To calculate the rms power delivered to the load, consider

- Peak to rms ratio of the digital waveform
- Any digital backoff from digital full scale
- DAC sinc response and nonideal losses in the external network
- DAC analog roll-off due to switch parasitic capacitance and load impedance

For example, a sine wave with no digital backoff ideally measures 6 dBm. If a typical balun loss of 1.2 dB is included, expect to measure 4.8 dBm of actual power in the region where the sinc response of the DAC has negligible influence and analog roll-off has not begun. Increasing the output power is best accomplished by increasing I_{OUTFS}. An example of DAC output characteristics for several balun and board types is shown in Figure 137.

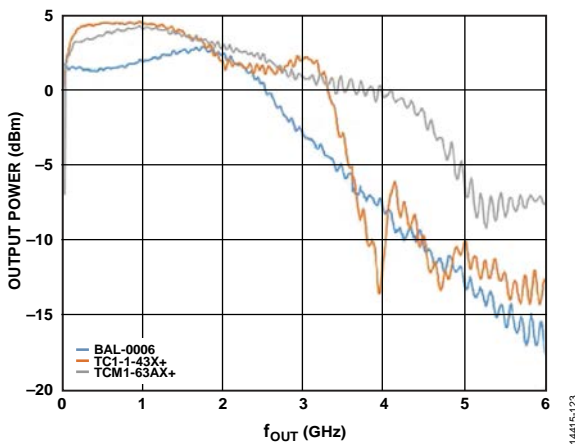

Figure 137. Measured DAC Output Response; f_{DAC} = 6 GSFS

Output Stage Configuration

The AD9163 is intended to serve high dynamic range applications that require wide signal reconstruction bandwidth (such as a DOCSIS cable modem termination system (CMTS)) and/or high IF/RF signal generation. Optimum ac performance can be realized only when the DAC output is configured for differential (that is, balanced) operation with its output common-mode voltage biased to a stable, low noise 2.5 V nominal analog supply (VDD25_DAC).

The output network used to interface to the DAC provides a near 0 Ω dc bias path to VDD25_DAC. Any imbalance in the output impedance over frequency between the OUTPUT+ and OUTPUT- pins degrades the distortion performance (mostly even order) and noise performance. Component selection and layout are critical in realizing the performance potential of the AD9163.

Most applications that require balanced to unbalanced conversion from 10 MHz to 3 GHz can take advantage of several available transformers that offer impedance ratios of both 2:1 and 1:1.

Figure 138 shows the AD9163 interfacing to the Mini-Circuits TCM1-63AX+ and the TC1-1-43X+ transformers.

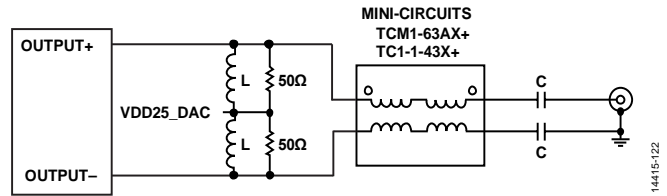

Figure 138. Recommended Transformer for Wideband Applications with Upper Bandwidths of up to 5 GHz

To assist in matching the AD9163 output, an equivalent model of the output was developed, and is shown in Figure 139. This equivalent model includes all effects from the ideal 40 mA current source in the die to the ball of the CSP_BGA package, including parasitic capacitance, trace inductance and resistance, contact resistance of solder bumps, via inductance, and other effects.

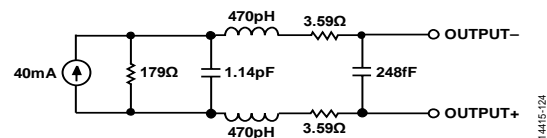
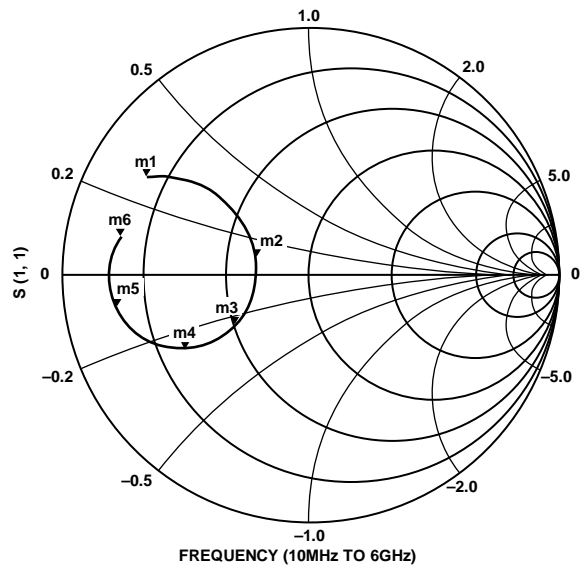

Figure 139. Equivalent Circuit Model of the DAC Output

A Smith chart is provided in Figure 140 showing the simulated S₁₁ of the DAC output, using the model in Figure 139. The plot was taken using the circuit in Figure 139, with a 100 Ω differential load instead of the balun. For the measured response of the DAC output, see Figure 137.



<p>m1 FREQUENCY = 10MHz S (1, 1) = 0.770/149.556 IMPEDANCE = Z₀ × (0.140 + j0.267)</p>	<p>m4 FREQUENCY = 2GHz S (1, 1) = 0.583/-148.777 IMPEDANCE = Z₀ × (0.282 - j0.259)</p>
<p>m2 FREQUENCY = 100MHz S (1, 1) = 0.227/163.083 IMPEDANCE = Z₀ × (0.638 + j0.089)</p>	<p>m5 FREQUENCY = 4GHz S (1, 1) = 0.794/-170.517 IMPEDANCE = Z₀ × (0.116 - j0.082)</p>
<p>m3 FREQUENCY = 1GHz S (1, 1) = 0.367/-144.722 IMPEDANCE = Z₀ × (0.499 - j0.245)</p>	<p>m6 FREQUENCY = 6GHz S (1, 1) = 0.779/168.448 IMPEDANCE = Z₀ × (0.125 + j0.100)</p>

Figure 140. Simulated Smith Chart Showing the DAC Output Impedance, Z₀ = 100 Ω

START-UP SEQUENCE

A number of steps is required to program the AD9163 to the proper operating state after the device is powered up. This sequence is divided into several steps, and is listed in Table 41, Table 42, and Table 43, along with an explanation of the purpose of each step. Private registers are reserved but must be written for proper operation. Blank cells in Table 41 to Table 43 mean that the value depends on the result as described in the description column.

The AD9163 is calibrated at the factory as part of the automatic test program. The configure DAC start-up sequence loads the factory calibration coefficients, as well as configures some

parameters that optimize the performance of the DAC and the DAC clock DLL (see Table 41). Run this sequence whenever the DAC is powered down or reset.

The configure JESD204B sequence configures the SERDES block and then brings up the links (see Table 42). First, run the configure DAC start-up sequence, then run the configure JESD204B sequence.

Follow the configure NCO sequence if using the NCO (see Table 43). The configure DAC start-up sequence is run first, then the configure NCO sequence.

Table 41. Configure DAC Start-Up Sequence After Power-Up

R/W	Register	Value	Description
W	0x000	0x18	Configure the device for 4-wire serial port operation (optional: leave at the default of 3-wire SPI)
W	0x0D2	0x52	Reset internal calibration registers (private)
W	0x0D2	0xD2	Clear the reset bit for the internal calibration registers (private)
W	0x606	0x02	Configure the nonvolatile random access memory (NVRAM) (private)
W	0x607	0x00	Configure the NVRAM (private)
W	0x604	0x01	Load the NVRAM; loads factory calibration factors from the NVRAM (private)
R	0x003, 0x004, 0x005, 0x006	N/A ¹	(Optional) read CHIP_TYPE, PROD_ID[15:0], PROD_GRADE, and DEV_REVISION from Register 0x003, Register 0x004, Register 0x005, and Register 0x006
R	0x604, Bit 1	0b1	(Optional) read the boot loader pass bit in Register 0x604, Bit 1 = 0b1 to indicate a successful boot load (private)
W	0x058	0x03	Enable the band gap reference (private)
W	0x090	0x1E	Power up the DAC clock DLL
W	0x080	0x00	Enable the clock receiver
W	0x040	0x00	Enable the DAC bias circuits
W	0x020	0x0F	(Optional) enable the interrupts
W	0x09E	0x85	Configure DAC analog parameters (private)
W	0x091	0xE9	Enable the DAC clock DLL
R	0x092, Bit 0	0b1	Check DLL_STATUS; set Register 0x092, Bit 0 = 1 to indicate the DAC clock DLL is locked to the DAC clock input
W	0x0E8	0x20	Enable calibration factors (private)
W	0x152, Bits[1:0]		Configure the DAC decode mode (0b00 = NRZ, 0b01 = Mix-Mode, or 0b10 = RZ)

¹ N/A means not applicable.

Table 42. Configure JESD204B Start-Up Sequence

R/W	Register	Value	Description
W	0x300	0x00	Ensure the SERDES links are disabled before configuring them.
W	0x4B8	0xFF	Enable JESD204B interrupts.
W	0x4B9	0x01	Enable JESD204B interrupts.
W	0x480	0x38	Enable SERDES error counters.
W	0x481	0x38	Enable SERDES error counters.
W	0x482	0x38	Enable SERDES error counters.
W	0x483	0x38	Enable SERDES error counters.
W	0x484	0x38	Enable SERDES error counters.
W	0x485	0x38	Enable SERDES error counters.
W	0x486	0x38	Enable SERDES error counters.
W	0x487	0x38	Enable SERDES error counters.
W	0x110		Configure number of lanes (Bits[7:4]) and interpolation rate (Bits[3:0]).

R/W	Register	Value	Description
W	0x111		Configure the datapath options for Bit 7 (INVSINC_EN), Bit 6 (NCO_EN), Bit 4 (FILT_BW), Bit 2 (MODULUS_EN), Bit 1 (SEL_SIDE BAND), and Bit 0 (FIR85_FILT_EN). See the Register Summary section for details on the options. Set the reserved bits (Bit 5 and Bit 3) to 0b0.
W	0x230		Configure the CDR block according to Table 18 for both half rate enable and the divider.
W	0x289, Bits[1:0]		Set up the SERDES PLL divider based on the conditions shown in Table 17.
W	0x084, Bits[5:4]		Set up the PLL reference clock rate based on the conditions shown in Table 17.
W	0x200	0x00	Enable JESD204B block (disable master SERDES power-down).
W	0x475	0x09	Soft reset of the JESD204B quad-byte deframer.
W	0x453, Bit 7	0b1	(Optional) enable scrambling on SERDES lanes.
W	0x458, Bits[7:5]		Set the subclass type: 0b000 = Subclass 0, 0b001 = Subclass 1.
W	0x459, Bits[7:5]	0b1	Set the JESD204x version to JESD204B.
W	0x45D		Program the calculated checksum value for Lane 0 from values in Register 0x450 to Register 0x45C.
W	0x475	0x01	Bring the JESD204B quad-byte deframer out of reset.
W	0x201, Bits[7:0]		Set any bits to 1 to power down the appropriate physical lane.
W	0x2A7	0x01	(Optional) calibrate SERDES PHY Termination Block 1 (PHY 0, PHY 1, PHY 6, PHY 7).
W	0x2AE	0x01	(Optional) calibrate SERDES PHY Termination Block 2 (PHY 2, PHY 3, PHY 4, PHY 5).
W	0x29E	0x1F	Override defaults in the SERDES PLL settings (private).
W	0x206	0x00	Reset the CDR.
W	0x206	0x01	Enable the CDR.
W	0x280	0x03	Enable the SERDES PLL.
R	0x281, Bit 0	0b1	Read back Register 0x281 until Bit 0 = 1 to indicate the SERDES PLL is locked. Prior to enabling the links, be sure that the JESD204B transmitter is enabled and ready to begin bringing up the link.
W	0x300	0x01	Enable SERDES links (begin bringing up the link).
R	0x470	0xFF	Read the CGS status for all lanes.
R	0x471	0xFF	Read the frame sync status for all lanes.
R	0x472	0xFF	Read the good checksum status for all lanes.
R	0x473	0xFF	Read the initial lane sync status for all lanes.
W	0x024	0x1F	Clear the interrupts.
W	0x4BA	0xFF	Clear the SERDES interrupts.
W	0x4BB	0x01	Clear the SERDES interrupt.

Table 43. Configure NCO Sequence

R/W	Register	Value	Description
W	0x111, Bit 6	0b1	Configure NCO_EN (Bit 6) = 0b1. Configure other datapath options for Bit 7 (INVSINC_EN), Bit 4 (FILT_BW), Bit 2 (MODULUS_EN), Bit 1 (SEL_SIDE BAND), and Bit 0 (FIR85_FILT_EN). See the Register Summary section for details on the options. Set the reserved bits (Bit 5 and Bit 3) to 0b0.
W	0x113	0x00	Ensure the frequency tuning word write request is low.
W	0x119		Write FTW, Bits[47:40].
W	0x118		Write FTW, Bits[39:32].
W	0x117		Write FTW, Bits[31:24].
W	0x116		Write FTW, Bits[23:16].
W	0x115		Write FTW, Bits[15:8].
W	0x114		Write FTW, Bits[7:0].
W	0x113	0x01	Load the FTW to the NCO.

REGISTER SUMMARY

Table 44. Register Summary

Reg.	Name	Bits	Bit 7	Bit 6	Bit 5	Bit 4	Bit 3	Bit 2	Bit 1	Bit 0	Reset	RW			
0x000	SPL_INTFCONFA	[7:0]	SOFTRESET_M	LSBFIRST_M	ADDRINC_M	SDOACTIVE_M	SDOACTIVE	ADDRINC	LSBFIRST	SOFTRESET	0x00	R/W			
0x001	SPL_INTFCONFB	[7:0]	SINGLEINS	\overline{CS} STALL	RESERVED			SOFTRESET1	SOFTRESET0	RESERVED	0x00	R/W			
0x002	SPL_DEVCONF	[7:0]	DEVSTATUS				CUSTOPMODE		SYSOPMODE			0x00	R/W		
0x003	SPL_CHIPTYPE	[7:0]	CHIP_TYPE									0x00	R		
0x004	SPL_PRODIDL	[7:0]	PROD_ID[7:0]									0x00	R		
0x005	SPL_PRODIDH	[7:0]	PROD_ID[15:8]									0x00	R		
0x006	SPL_CHIPGRADE	[7:0]	PROD_GRADE				DEV_REVISION					0x00	R		
0x020	IRQ_ENABLE	[7:0]	RESERVED			EN_SYSREF_JITTER	EN_DATA_READY	EN_LANE_FIFO	EN_PRBSQ	EN_PRBSI		0x00	R/W		
0x024	IRQ_STATUS	[7:0]	RESERVED			IRQ_SYSREF_JITTER	IRQ_DATA_READY	IRQ_LANE_FIFO	IRQ_PRBSQ	IRQ_PRBSI		0x00	R/W		
0x031	SYNC_LMFC_DELAY_FRAME	[7:0]	RESERVED			SYNC_LMFC_DELAY_SET_FRM						0x00	R/W		
0x032	SYNC_LMFC_DELAY0	[7:0]	SYNC_LMFC_DELAY_SET[7:0]									0x00	R/W		
0x033	SYNC_LMFC_DELAY1	[7:0]	RESERVED				SYNC_LMFC_DELAY_SET[11:8]					0x00	R/W		
0x034	SYNC_LMFC_STAT0	[7:0]	SYNC_LMFC_DELAY_STAT[7:0]									0x00	R/W		
0x035	SYNC_LMFC_STAT1	[7:0]	RESERVED				SYNC_LMFC_DELAY_STAT[11:8]					0x00	R/W		
0x036	SYSREF_COUNT	[7:0]	SYSREF_COUNT									0x00	R/W		
0x037	SYSREF_PHASE0	[7:0]	SYSREF_PHASE[7:0]									0x00	R/W		
0x038	SYSREF_PHASE1	[7:0]	RESERVED				SYSREF_PHASE[11:8]					0x00	R/W		
0x039	SYSREF_JITTER_WINDOW	[7:0]	RESERVED			SYSREF_JITTER_WINDOW						0x00	R/W		
0x03A	SYNC_CTRL	[7:0]	RESERVED						SYNC_MODE					0x00	R/W
0x03F	TX_ENABLE	[7:0]	SPL_DATAPATH_POST	SPL_DATAPATH_PRE	RESERVED		TXEN_NCO_RESET	TXEN_DATAPATH_POST	TXEN_DATAPATH_PRE	TXEN_DAC_FSC	0xC0	R/W			
0x040	ANA_DAC_BIAS_PD	[7:0]	RESERVED						ANA_DAC_BIAS_PD1	ANA_DAC_BIAS_PD0	0x03		R/W		
0x041	ANA_FSC0	[7:0]	RESERVED						ANA_FULL_SCALE_CURRENT[1:0]					0x03	R/W
0x042	ANA_FSC1	[7:0]	ANA_FULL_SCALE_CURRENT[9:2]									0xFF	R/W		
0x07F	CLK_PHASE_TUNE	[7:0]	RESERVED			CLK_PHASE_TUNE						0x00	R/W		
0x080	CLK_PD	[7:0]	RESERVED								DACCLK_PD	0x01	R/W		
0x082	CLK_DUTY	[7:0]	CLK_DUTY_EN	CLK_DUTY_OFFSET_EN	CLK_DUTY_BOOST_EN	CLK_DUTY_PRG						0x80	R/W		
0x083	CLK_CRS_CTRL	[7:0]	CLK_CRS_EN	RESERVED			CLK_CRS_ADJ					0x80	R/W		
0x084	PLL_REF_CLK_PD	[7:0]	RESERVED		PLL_REF_CLK_RATE		RESERVED			PLL_REF_CLK_PD	0x00	R/W			
0x088	SYSREF_CTRL0	[7:0]	RESERVED				HYS_ON	SYSREF_RISE	HYS_CNTRL[9:8]				0x00	R/W	
0x089	SYSREF_CTRL1	[7:0]	HYS_CNTRL[7:0]									0x00	R/W		
0x090	DLL_PD	[7:0]	RESERVED			DLL_FINE_DC_EN	DLL_FINE_XC_EN	DLL_COARSE_DC_EN	DLL_COARSE_XC_EN	DLL_CLK_PD			0x1F	R/W	
0x091	DLL_CTRL	[7:0]	DLL_TRACK_ERR	DLL_SEARCH_ERR	DLL_SLOPE	DLL_SEARCH		DLL_MODE		DLL_ENABLE			0xF0	R/W	
0x092	DLL_STATUS	[7:0]	RESERVED						DLL_FAIL	DLL_LOST	DLL_LOCKED			0x00	R/W
0x093	DLL_GB	[7:0]	RESERVED				DLL_GUARD					0x00	R/W		
0x094	DLL_COARSE	[7:0]	RESERVED			DLL_COARSE						0x00	R/W		
0x095	DLL_FINE	[7:0]	DLL_FINE									0x80	R/W		

Reg.	Name	Bits	Bit 7	Bit 6	Bit 5	Bit 4	Bit 3	Bit 2	Bit 1	Bit 0	Reset	RW			
0x096	DLL_PHASE	[7:0]	RESERVED			DLL_PHS						0x08	R/W		
0x097	DLL_BW	[7:0]	RESERVED			DLL_FILT_BW			DLL_WEIGHT			0x00	R/W		
0x098	DLL_READ	[7:0]	RESERVED							DLL_READ		0x00	R/W		
0x099	DLL_COARSE_RB	[7:0]	RESERVED		DLL_COARSE_RB							0x00	R		
0x09A	DLL_FINE_RB	[7:0]	DLL_FINE_RB										0x00	R	
0x09B	DLL_PHASE_RB	[7:0]	RESERVED			DLL_PHS_RB							0x00	R	
0x09D	DIG_CLK_INVERT	[7:0]	RESERVED					INV_DIG_CLK	DIG_CLK_DC_EN	DIG_CLK_XC_EN			0x03	R/W	
0x0A0	DLL_CLK_DEBUG	[7:0]	DLL_TEST_EN	RESERVED					DLL_TEST_DIV				0x00	R/W	
0x110	INTERP_MODE	[7:0]	JESD_LANES				INTERP_MODE						0x81	R/W	
0x111	DATAPATH_CFG	[7:0]	INVSINC_EN	NCO_EN	RESERVED	FILT_BW	RESERVED	MODULUS_EN	SEL_SIDE BAND	FIR85_FILT_EN	0x00	R/W			
0x113	FTW_UPDATE	[7:0]	RESERVED	FTW_REQ_MODE			RESERVED	FTW_LOAD_SYSREF	FTW_LOAD_ACK	FTW_LOAD_REQ	0x00	R/W			
0x114	FTW0	[7:0]	FTW[7:0]										0x00	R/W	
0x115	FTW1	[7:0]	FTW[15:8]										0x00	R/W	
0x116	FTW2	[7:0]	FTW[23:16]										0x00	R/W	
0x117	FTW3	[7:0]	FTW[31:24]										0x00	R/W	
0x118	FTW4	[7:0]	FTW[39:32]										0x00	R/W	
0x119	FTW5	[7:0]	FTW[47:40]										0x00	R/W	
0x11C	PHASE_OFFSET0	[7:0]	NCO_PHASE_OFFSET[7:0]										0x00	R/W	
0x11D	PHASE_OFFSET1	[7:0]	NCO_PHASE_OFFSET[15:8]										0x00	R/W	
0x124	ACC_MODULUS0	[7:0]	ACC_MODULUS[7:0]										0x00	R/W	
0x125	ACC_MODULUS1	[7:0]	ACC_MODULUS[15:8]										0x00	R/W	
0x126	ACC_MODULUS2	[7:0]	ACC_MODULUS[23:16]										0x00	R/W	
0x127	ACC_MODULUS3	[7:0]	ACC_MODULUS[31:24]										0x00	R/W	
0x128	ACC_MODULUS4	[7:0]	ACC_MODULUS[39:32]										0x00	R/W	
0x129	ACC_MODULUS5	[7:0]	ACC_MODULUS[47:40]										0x00	R/W	
0x12A	ACC_DELTA0	[7:0]	ACC_DELTA[7:0]										0x00	R/W	
0x12B	ACC_DELTA1	[7:0]	ACC_DELTA[15:8]										0x00	R/W	
0x12C	ACC_DELTA2	[7:0]	ACC_DELTA[23:16]										0x00	R/W	
0x12D	ACC_DELTA3	[7:0]	ACC_DELTA[31:24]										0x00	R/W	
0x12E	ACC_DELTA4	[7:0]	ACC_DELTA[39:32]										0x00	R/W	
0x12F	ACC_DELTA5	[7:0]	ACC_DELTA[47:40]										0x00	R/W	
0x132	TEMP_SENS_LSB	[7:0]	TEMP_SENS_OUT[7:0]										0x00	R	
0x133	TEMP_SENS_MSB	[7:0]	TEMP_SENS_OUT[15:8]										0x00	R	
0x134	TEMP_SENS_UPDATE	[7:0]	RESERVED							TEMP_SENS_UPDATE			0x00	R/W	
0x135	TEMP_SENS_CTRL	[7:0]	TEMP_SENS_FAST	RESERVED							TEMP_SENS_ENABLE	0x20			
0x14B	PRBS	[7:0]	PRBS_GOOD_Q	PRBS_GOOD_I	RESERVED	PRBS_INV_Q	PRBS_INV_I	PRBS_MODE	PRBS_RESET	PRBS_EN	0x10	R/W			
0x14C	PRBS_ERROR_I	[7:0]	PRBS_COUNT_I										0x00	R	
0x14D	PRBS_ERROR_Q	[7:0]	PRBS_COUNT_Q										0x00	R	
0x151	DECODE_CTRL	[7:0]	RESERVED					SHUFFLE	RESERVED				0x01	R/W	
0x152	DECODE_MODE	[7:0]	RESERVED						DECODE_MODE				0x00	R/W	
0x1DF	SPI_STRENGTH	[7:0]	RESERVED				SPIDRV					0x0F	R/W		
0x200	MASTER_PD	[7:0]	RESERVED							SPL_PD_MASTER				0x01	R/W
0x201	PHY_PD	[7:0]	SPL_PD_PHY										0x00	R/W	
0x203	GENERIC_PD	[7:0]	RESERVED						SPI_SYNC1_PD	RESERVED			0x00	R/W	
0x206	CDR_RESET	[7:0]	RESERVED							SPL_CDR_RESET				0x01	R/W

Reg.	Name	Bits	Bit 7	Bit 6	Bit 5	Bit 4	Bit 3	Bit 2	Bit 1	Bit 0	Reset	RW		
0x230	CDR_OPERATING_MODE_REG_0	[7:0]	RESERVED		SPI_ENHALFRATE	RESERVED		SPI_DIVISION_RATE		RESERVED	0x28	R/W		
0x250	EQ_CONFIG_PHY_0_1	[7:0]	SPI_EQ_CONFIG1				SPI_EQ_CONFIG0				0x88	R/W		
0x251	EQ_CONFIG_PHY_2_3	[7:0]	SPI_EQ_CONFIG3				SPI_EQ_CONFIG2				0x88	R/W		
0x252	EQ_CONFIG_PHY_4_5	[7:0]	SPI_EQ_CONFIG5				SPI_EQ_CONFIG4				0x88	R/W		
0x253	EQ_CONFIG_PHY_6_7	[7:0]	SPI_EQ_CONFIG7				SPI_EQ_CONFIG6				0x88	R/W		
0x268	EQ_BIAS_REG	[7:0]	EQ_POWER_MODE		RESERVED						0x62	R/W		
0x280	SYNTH_ENABLE_CNTRL	[7:0]	RESERVED					SPI_RECAL_SYNTH	RESERVED	SPI_ENABLE_SYNTH	0x00	R/W		
0x281	PLL_STATUS	[7:0]	RESERVED		SPI_CP_OVER_RANGE_HIGH_RB	SPI_CP_OVER_RANGE_LOW_RB	SPI_CP_CAL_VALID_RB	RESERVED		SPI_PLL_LOCK_RB	0x00	R		
0x289	REF_CLK_DIVIDER_LDO	[7:0]	RESERVED						SERDES_PLL_DIV_FACTOR		0x04	R/W		
0x2A7	TERM_BLK1_CTRLREG0	[7:0]	RESERVED							SPI_L_TUNE_R_CAL_TERMBLK1	0x00	R/W		
0x2A8	TERM_BLK1_CTRLREG1	[7:0]	SPI_I_SERIALIZER_RTRIM_TERMBLK1										0x00	R/W
0x2AC	TERM_BLK1_RD_REG0	[7:0]	RESERVED				SPI_O_RCAL_CODE_TERMBLK1				0x00	R		
0x2AE	TERM_BLK2_CTRLREG0	[7:0]	RESERVED							SPI_L_TUNE_R_CAL_TERMBLK2	0x00	R/W		
0x2AF	TERM_BLK2_CTRLREG1	[7:0]	SPI_I_SERIALIZER_RTRIM_TERMBLK2										0x00	R/W
0x2B3	TERM_BLK2_RD_REG0	[7:0]	RESERVED				SPI_O_RCAL_CODE_TERMBLK2				0x00	R		
0x2BB	TERM_OFFSET_0	[7:0]	RESERVED				TERM_OFFSET_0				0x00	R/W		
0x2BC	TERM_OFFSET_1	[7:0]	RESERVED				TERM_OFFSET_1				0x00	R/W		
0x2BD	TERM_OFFSET_2	[7:0]	RESERVED				TERM_OFFSET_2				0x00	R/W		
0x2BE	TERM_OFFSET_3	[7:0]	RESERVED				TERM_OFFSET_3				0x00	R/W		
0x2BF	TERM_OFFSET_4	[7:0]	RESERVED				TERM_OFFSET_4				0x00	R/W		
0x2C0	TERM_OFFSET_5	[7:0]	RESERVED				TERM_OFFSET_5				0x00	R/W		
0x2C1	TERM_OFFSET_6	[7:0]	RESERVED				TERM_OFFSET_6				0x00	R/W		
0x2C2	TERM_OFFSET_7	[7:0]	RESERVED				TERM_OFFSET_7				0x00	R/W		
0x300	GENERAL_JRX_CTRL_0	[7:0]	RESERVED	CHECKSUM_MODE	RESERVED					LINK_EN	0x00	R/W		
0x302	DYN_LINK_LATENCY_0	[7:0]	RESERVED				DYN_LINK_LATENCY_0				0x00	R		
0x304	LMFC_DELAY_0	[7:0]	RESERVED				LMFC_DELAY_0				0x00	R/W		
0x306	LMFC_VAR_0	[7:0]	RESERVED				LMFC_VAR_0				0x1F	R/W		
0x308	XBAR_LN_0_1	[7:0]	RESERVED		SRC_LANE1			SRC_LANE0			0x08	R/W		
0x309	XBAR_LN_2_3	[7:0]	RESERVED		SRC_LANE3			SRC_LANE2			0x1A	R/W		
0x30A	XBAR_LN_4_5	[7:0]	RESERVED		SRC_LANE5			SRC_LANE4			0x2C	R/W		
0x30B	XBAR_LN_6_7	[7:0]	RESERVED		SRC_LANE7			SRC_LANE6			0x3E	R/W		
0x30C	FIFO_STATUS_REG_0	[7:0]	LANE_FIFO_FULL										0x00	R
0x30D	FIFO_STATUS_REG_1	[7:0]	LANE_FIFO_EMPTY										0x00	R
0x311	SYNC_GEN_0	[7:0]	RESERVED					EOMF_MASK_0	RESERVED	EOF_MASK_0	0x00	R/W		
0x312	SYNC_GEN_1	[7:0]	SYNC_ERR_DUR				SYNC_SYNCREQ_DUR				0x00	R/W		
0x313	SYNC_GEN_3	[7:0]	LMFC_PERIOD										0x00	R

Reg.	Name	Bits	Bit 7	Bit 6	Bit 5	Bit 4	Bit 3	Bit 2	Bit 1	Bit 0	Reset	RW	
0x315	PHY_PRBS_TEST_EN	[7:0]	PHY_TEST_EN									0x00	R/W
0x316	PHY_PRBS_TEST_CTRL	[7:0]	RESERVED	PHY_SRC_ERR_CNT			PHY_PRBS_PAT_SEL		PHY_TEST_START	PHY_TEST_RESET	0x00	R/W	
0x317	PHY_PRBS_TEST_THRESHOLD_LOBITS	[7:0]	PHY_PRBS_THRESHOLD_LOBITS									0x00	R/W
0x318	PHY_PRBS_TEST_THRESHOLD_MIDBITS	[7:0]	PHY_PRBS_THRESHOLD_MIDBITS									0x00	R/W
0x319	PHY_PRBS_TEST_THRESHOLD_HIBITS	[7:0]	PHY_PRBS_THRESHOLD_HIBITS									0x00	R/W
0x31A	PHY_PRBS_TEST_ERRCNT_LOBITS	[7:0]	PHY_PRBS_ERR_CNT_LOBITS									0x00	R
0x31B	PHY_PRBS_TEST_ERRCNT_MIDBITS	[7:0]	PHY_PRBS_ERR_CNT_MIDBITS									0x00	R
0x31C	PHY_PRBS_TEST_ERRCNT_HIBITS	[7:0]	PHY_PRBS_ERR_CNT_HIBITS									0x00	R
0x31D	PHY_PRBS_TEST_STATUS	[7:0]	PHY_PRBS_PASS									0xFF	R
0x31E	PHY_DATA_SNAPSHOT_CTRL	[7:0]	RESERVED			PHY_GRAB_LANE_SEL			PHY_GRAB_MODE	PHY_GRAB_DATA	0x00	R/W	
0x31F	PHY_SNAPSHOT_DATA_BYTE0	[7:0]	PHY_SNAPSHOT_DATA_BYTE0									0x00	R
0x320	PHY_SNAPSHOT_DATA_BYTE1	[7:0]	PHY_SNAPSHOT_DATA_BYTE1									0x00	R
0x321	PHY_SNAPSHOT_DATA_BYTE2	[7:0]	PHY_SNAPSHOT_DATA_BYTE2									0x00	R
0x322	PHY_SNAPSHOT_DATA_BYTE3	[7:0]	PHY_SNAPSHOT_DATA_BYTE3									0x00	R
0x323	PHY_SNAPSHOT_DATA_BYTE4	[7:0]	PHY_SNAPSHOT_DATA_BYTE4									0x00	R
0x32C	SHORT_TPL_TEST_0	[7:0]	SHORT_TPL_SP_SEL			SHORT_TPL_M_SEL		SHORT_TPL_TEST_RESET	SHORT_TPL_TEST_EN	0x00	R/W		
0x32D	SHORT_TPL_TEST_1	[7:0]	SHORT_TPL_REF_SP_LSB									0x00	R/W
0x32E	SHORT_TPL_TEST_2	[7:0]	SHORT_TPL_REF_SP_MSB									0x00	R/W
0x32F	SHORT_TPL_TEST_3	[7:0]	RESERVED								SHORT_TPL_FAIL	0x00	R
0x334	JESD_BIT_INVERSE_CTRL	[7:0]	JESD_BIT_INVERSE									0x00	R/W
0x400	DID_REG	[7:0]	DID_RD									0x00	R
0x401	BID_REG	[7:0]	BID_RD									0x00	R
0x402	LIDO_REG	[7:0]	RESERVED	ADJDIR_RD	PHADJ_RD	LL_LIDO						0x00	R
0x403	SCR_L_REG	[7:0]	SCR_RD	RESERVED			L_RD			0x00	R		
0x404	F_REG	[7:0]	F_RD									0x00	R
0x405	K_REG	[7:0]	RESERVED				K_RD				0x00	R	
0x406	M_REG	[7:0]	M_RD									0x00	R
0x407	CS_N_REG	[7:0]	CS_RD		RESERVED			N_RD			0x00	R	
0x408	NP_REG	[7:0]	SUBCLASSV_RD				NP_RD				0x00	R	
0x409	S_REG	[7:0]	JESDV_RD				S_RD				0x00	R	
0x40A	HD_CF_REG	[7:0]	HD_RD	RESERVED			CF_RD			0x00	R		
0x40B	RES1_REG	[7:0]	RES1_RD									0x00	R
0x40C	RES2_REG	[7:0]	RES2_RD									0x00	R
0x40D	CHECKSUM0_REG	[7:0]	LL_FCHK0									0x00	R
0x40E	COMPSUM0_REG	[7:0]	LL_FCMP0									0x00	R

Reg.	Name	Bits	Bit 7	Bit 6	Bit 5	Bit 4	Bit 3	Bit 2	Bit 1	Bit 0	Reset	RW
0x412	LID1_REG	[7:0]	RESERVED			LL_LID1					0x00	R
0x415	CHECKSUM1_REG	[7:0]	RESERVED					LL_FCHK1			0x00	R
0x416	COMPNUM1_REG	[7:0]	RESERVED					LL_FCMP1			0x00	R
0x41A	LID2_REG	[7:0]	RESERVED			LL_LID2					0x00	R
0x41D	CHECKSUM2_REG	[7:0]	RESERVED					LL_FCHK2			0x00	R
0x41E	COMPNUM2_REG	[7:0]	RESERVED					LL_FCMP2			0x00	R
0x422	LID3_REG	[7:0]	RESERVED			LL_LID3					0x00	R
0x425	CHECKSUM3_REG	[7:0]	RESERVED					LL_FCHK3			0x00	R
0x426	COMPNUM3_REG	[7:0]	RESERVED					LL_FCMP3			0x00	R
0x42A	LID4_REG	[7:0]	RESERVED			LL_LID4					0x00	R
0x42D	CHECKSUM4_REG	[7:0]	RESERVED					LL_FCHK4			0x00	R
0x42E	COMPNUM4_REG	[7:0]	RESERVED					LL_FCMP4			0x00	R
0x432	LID5_REG	[7:0]	RESERVED			LL_LID5					0x00	R
0x435	CHECKSUM5_REG	[7:0]	RESERVED					LL_FCHK5			0x00	R
0x436	COMPNUM5_REG	[7:0]	RESERVED					LL_FCMP5			0x00	R
0x43A	LID6_REG	[7:0]	RESERVED			LL_LID6					0x00	R
0x43D	CHECKSUM6_REG	[7:0]	RESERVED					LL_FCHK6			0x00	R
0x43E	COMPNUM6_REG	[7:0]	RESERVED					LL_FCMP6			0x00	R
0x442	LID7_REG	[7:0]	RESERVED			LL_LID7					0x00	R
0x445	CHECKSUM7_REG	[7:0]	RESERVED					LL_FCHK7			0x00	R
0x446	COMPNUM7_REG	[7:0]	RESERVED					LL_FCMP7			0x00	R
0x450	ILS_DID	[7:0]	RESERVED					DID			0x00	R/W
0x451	ILS_BID	[7:0]	RESERVED					BID			0x00	R/W
0x452	ILS_LID0	[7:0]	RESERVED	ADJDIR	PHADJ	LID0				0x00	R/W	
0x453	ILS_SCR_L	[7:0]	SCR	RESERVED			L			0x87	R/W	
0x454	ILS_F	[7:0]	RESERVED					F			0x00	R
0x455	ILS_K	[7:0]	RESERVED					K			0x1F	R/W
0x456	ILS_M	[7:0]	RESERVED					M			0x01	R
0x457	ILS_CS_N	[7:0]	CS		RESERVED		N			0x0F	R	
0x458	ILS_NP	[7:0]	SUBCLASSV					NP			0x0F	R/W
0x459	ILS_S	[7:0]	JESDV					S			0x01	R/W
0x45A	ILS_HD_CF	[7:0]	HD	RESERVED			CF			0x80	R	
0x45B	ILS_RES1	[7:0]	RESERVED					RES1			0x00	R/W
0x45C	ILS_RES2	[7:0]	RESERVED					RES2			0x00	R/W
0x45D	ILS_CHECKSUM	[7:0]	RESERVED					FCHK0			0x00	R/W
0x46C	LANE_DESKEW	[7:0]	ILD7	ILS6	ILD5	ILD4	ILD3	ILD2	ILD1	ILD0	0x00	R
0x46D	BAD_DISPARITY	[7:0]	BDE7	BDE6	BDE5	BDE4	BDE3	BDE2	BDE1	BDE0	0x00	R
0x46E	NOT_IN_TABLE	[7:0]	NIT7	NIT6	NIT5	NIT4	NIT3	NIT2	NIT1	NIT0	0x00	R
0x46F	UNEXPECTED_KCHAR	[7:0]	UEK7	UEK6	UEK5	UEK4	UEK3	UEK2	UEK1	UEK0	0x00	R
0x470	CODE_GRP_SYNC	[7:0]	CGS7	CGS6	CGS5	CGS4	CGS3	CGS2	CGS1	CGS0	0x00	R
0x471	FRAME_SYNC	[7:0]	FS7	FS6	FS5	FS4	FS3	FS2	FS1	FS0	0x00	R
0x472	GOOD_CHECKSUM	[7:0]	CKS7	CKS6	CKS5	CKS4	CKS3	CKS2	CKS1	CKS0	0x00	R
0x473	INIT_LANE_SYNC	[7:0]	ILS7	ILS6	ILS5	ILS4	ILS3	ILS2	ILS1	ILS0	0x00	R
0x475	CTRLREG0	[7:0]	RX_DIS	CHAR_REPL_DIS	RESERVED		SOFTTRST	FORCESYNCREQ	RESERVED	REPL_FRM_ENA	0x01	R/W
0x476	CTRLREG1	[7:0]	RESERVED			QUAL_RDERR	DEL_SCR	CGS_SEL	NO_ILAS	FCHK_N	0x14	R/W
0x477	CTRLREG2	[7:0]	ILS_MODE	RESERVED	REPDATATEST	QUETESTERR	AR_ECINTR	RESERVED			0x00	R/W
0x478	KVAL	[7:0]	RESERVED					KSYNC			0x01	R/W

Reg.	Name	Bits	Bit 7	Bit 6	Bit 5	Bit 4	Bit 3	Bit 2	Bit 1	Bit 0	Reset	RW
0x47C	ERRORTHRES	[7:0]	ETH								0xFF	R/W
0x47D	SYNC_ASSERT_MASK	[7:0]	RESERVED					SYNC_ASSERT_MASK			0x07	R/W
0x480	ECNT_CTRL0	[7:0]	RESERVED		ECNT_ENA0		ECNT_RST0			0x3F	R/W	
0x481	ECNT_CTRL1	[7:0]	RESERVED		ECNT_ENA1		ECNT_RST1			0x3F	R/W	
0x482	ECNT_CTRL2	[7:0]	RESERVED		ECNT_ENA2		ECNT_RST2			0x3F	R/W	
0x483	ECNT_CTRL3	[7:0]	RESERVED		ECNT_ENA3		ECNT_RST3			0x3F	R/W	
0x484	ECNT_CTRL4	[7:0]	RESERVED		ECNT_ENA4		ECNT_RST4			0x3F	R/W	
0x485	ECNT_CTRL5	[7:0]	RESERVED		ECNT_ENA5		ECNT_RST5			0x3F	R/W	
0x486	ECNT_CTRL6	[7:0]	RESERVED		ECNT_ENA6		ECNT_RST6			0x3F	R/W	
0x487	ECNT_CTRL7	[7:0]	RESERVED		ECNT_ENA7		ECNT_RST7			0x3F	R/W	
0x488	ECNT_TCH0	[7:0]	RESERVED					ECNT_TCH0			0x07	R/W
0x489	ECNT_TCH1	[7:0]	RESERVED					ECNT_TCH1			0x07	R/W
0x48A	ECNT_TCH2	[7:0]	RESERVED					ECNT_TCH2			0x07	R/W
0x48B	ECNT_TCH3	[7:0]	RESERVED					ECNT_TCH3			0x07	R/W
0x48C	ECNT_TCH4	[7:0]	RESERVED					ECNT_TCH4			0x07	R/W
0x48D	ECNT_TCH5	[7:0]	RESERVED					ECNT_TCH5			0x07	R/W
0x48E	ECNT_TCH6	[7:0]	RESERVED					ECNT_TCH6			0x07	R/W
0x48F	ECNT_TCH7	[7:0]	RESERVED					ECNT_TCH7			0x07	R/W
0x490	ECNT_STAT0	[7:0]	RESERVED				LANE_ENA0		ECNT_TCR0		0x00	R
0x491	ECNT_STAT1	[7:0]	RESERVED				LANE_ENA1		ECNT_TCR1		0x00	R
0x492	ECNT_STAT2	[7:0]	RESERVED				LANE_ENA2		ECNT_TCR2		0x00	R
0x493	ECNT_STAT3	[7:0]	RESERVED				LANE_ENA3		ECNT_TCR3		0x00	R
0x494	ECNT_STAT4	[7:0]	RESERVED				LANE_ENA4		ECNT_TCR4		0x00	R
0x495	ECNT_STAT5	[7:0]	RESERVED				LANE_ENA5		ECNT_TCR5		0x00	R
0x496	ECNT_STAT6	[7:0]	RESERVED				LANE_ENA6		ECNT_TCR6		0x00	R
0x497	ECNT_STAT7	[7:0]	RESERVED				LANE_ENA7		ECNT_TCR7		0x00	R
0x498	BD_CNT0	[7:0]	BD_CNT0								0x00	R
0x499	BD_CNT1	[7:0]	BD_CNT1								0x00	R
0x49A	BD_CNT2	[7:0]	BD_CNT2								0x00	R
0x49B	BD_CNT3	[7:0]	BD_CNT3								0x00	R
0x49C	BD_CNT4	[7:0]	BD_CNT4								0x00	R
0x49D	BD_CNT5	[7:0]	BD_CNT5								0x00	R
0x49E	BD_CNT6	[7:0]	BD_CNT6								0x00	R
0x49F	BD_CNT7	[7:0]	BD_CNT7								0x00	R
0x4A0	NIT_CNT0	[7:0]	NIT_CNT0								0x00	R
0x4A1	NIT_CNT1	[7:0]	NIT_CNT1								0x00	R
0x4A2	NIT_CNT2	[7:0]	NIT_CNT2								0x00	R
0x4A3	NIT_CNT3	[7:0]	NIT_CNT3								0x00	R
0x4A4	NIT_CNT4	[7:0]	NIT_CNT4								0x00	R
0x4A5	NIT_CNT5	[7:0]	NIT_CNT5								0x00	R
0x4A6	NIT_CNT6	[7:0]	NIT_CNT6								0x00	R
0x4A7	NIT_CNT7	[7:0]	NIT_CNT7								0x00	R
0x4A8	UEK_CNT0	[7:0]	UEK_CNT0								0x00	R
0x4A9	UEK_CNT1	[7:0]	UEK_CNT1								0x00	R
0x4AA	UEK_CNT2	[7:0]	UEK_CNT2								0x00	R
0x4AB	UEK_CNT3	[7:0]	UEK_CNT3								0x00	R
0x4AC	UEK_CNT4	[7:0]	UEK_CNT4								0x00	R
0x4AD	UEK_CNT5	[7:0]	UEK_CNT5								0x00	R

Reg.	Name	Bits	Bit 7	Bit 6	Bit 5	Bit 4	Bit 3	Bit 2	Bit 1	Bit 0	Reset	RW	
0x4AE	UEK_CNT6	[7:0]	UEK_CNT6									0x00	R
0x4AF	UEK_CNT7	[7:0]	UEK_CNT7									0x00	R
0x4B0	LINK_STATUS0	[7:0]	BDE0	NIT0	UEK0	ILD0	ILS0	CKS0	FS0	CGS0	0x00	R	
0x4B1	LINK_STATUS1	[7:0]	BDE1	NIT1	UEK1	ILD1	ILS1	CKS1	FS1	CGS1	0x00	R	
0x4B2	LINK_STATUS2	[7:0]	BDE2	NIT2	UEK2	ILD2	ILS2	CKS2	FS2	CGS2	0x00	R	
0x4B3	LINK_STATUS3	[7:0]	BDE3	NIT3	UEK3	ILD3	ILS3	CKS3	FS3	CGS3	0x00	R	
0x4B4	LINK_STATUS4	[7:0]	BDE4	NIT4	UEK4	ILD4	ILS4	CKS4	FS4	CGS4	0x00	R	
0x4B5	LINK_STATUS5	[7:0]	BDE5	NIT5	UEK5	ILD5	ILS5	CKS5	FS5	CGS5	0x00	R	
0x4B6	LINK_STATUS6	[7:0]	BDE6	NIT6	UEK6	ILD6	ILS6	CKS6	FS6	CGS6	0x00	R	
0x4B7	LINK_STATUS7	[7:0]	BDE7	NIT7	UEK7	ILD7	ILS7	CKS7	FS7	CGS7	0x00	R	
0x4B8	JESD_IRQ_ENABLEA	[7:0]	EN_BDE	EN_NIT	EN_UEK	EN_ILD	EN_ILS	EN_CKS	EN_FS	EN_CGS	0x00	R/W	
0x4B9	JESD_IRQ_ENABLEB	[7:0]	RESERVED							EN_ILAS	0x00	R/W	
0x4BA	JESD_IRQ_STATUSA	[7:0]	IRQ_BDE	IRQ_NIT	IRQ_UEK	IRQ_ILD	IRQ_ILS	IRQ_CKS	IRQ_FS	IRQ_CGS	0x00	R/W	
0x4BB	JESD_IRQ_STATUSB	[7:0]	RESERVED							IRQ_ILAS	0x00	R/W	
0x800	HOPF_CTRL	[7:0]	HOPF_MODE			RESERVED					0x00	R/W	

REGISTER DETAILS

Table 45. Register Details

Hex. Addr.	Name	Bits	Bit Name	Settings	Description	Reset	Access
0x000	SPI_INTFCONFA	7	SOFTRESET_M		Soft reset (mirror). Set this to mirror Bit 0.	0x0	R
		6	LSBFIRST_M		LSB first (mirror). Set this to mirror Bit 1.	0x0	R
		5	ADDRINC_M		Address increment (mirror). Set this to mirror Bit 2.	0x0	R
		4	SDOACTIVE_M		SDO active (mirror). Set this to mirror Bit 3.	0x0	R
		3	SDOACTIVE		SDO active. Enables 4-wire SPI bus mode.	0x0	R/W
		2	ADDRINC		Address increment. When set, causes incrementing streaming addresses; otherwise, descending addresses are generated. 1 Streaming addresses are incremented. 0 Streaming addresses are decremented.	0x0	R/W
		1	LSBFIRST		LSB first. When set, causes input and output data to be oriented as LSB first. If this bit is clear, data is oriented as MSB first. 1 Shift LSB in first. 0 Shift MSB in first.	0x0	R/W
0x001	SPI_INTFCONFB	0	SOFTRESET		Soft reset. This bit automatically clears to 0 after performing a reset operation. Setting this bit initiates a reset. This bit is autoclearing after the soft reset is complete. 1 Pulse the soft reset line. 0 Reset the soft reset line.	0x0	R/W
		7	SINGLEINS		Single instruction. 1 Perform single transfers. 0 Perform multiple transfers.	0x0	R/W
		6	CSSTALL		\overline{CS} stalling. 0 Disable \overline{CS} stalling. 1 Enable \overline{CS} stalling.	0x0	R/W
		[5:3]	RESERVED		Reserved.	0x0	R/W
		2	SOFTRESET1		Soft Reset 1. This bit automatically clears to 0 after performing a reset operation. 1 Pulse the Soft Reset 1 line. 0 Pulse the Soft Reset 1 line.	0x0	R/W
		1	SOFTRESET0		Soft Reset 0. This bit automatically clears to 0 after performing a reset operation. 1 Pulse the Soft Reset 0 line. 0 Pulse the Soft Reset 0 line.	0x0	R/W
0x002	SPI_DEVCONF	[7:4]	DEVSTATUS		Device status.	0x0	R/W
		[3:2]	CUSTOPMODE		Customer operating mode.	0x0	R/W
		[1:0]	SYSOPMODE		System operating mode. 0 Normal operation. 1 Low power operation.	0x0	R/W

Hex. Addr.	Name	Bits	Bit Name	Settings	Description	Reset	Access
					2 Medium power standby. 3 Low power sleep.		
0x003	SPI_CHIPTYPE	[7:0]	CHIP_TYPE		Chip type.	0x0	R
0x004	SPI_PRODIDL	[7:0]	PROD_ID[7:0]		Product ID.	0x0	R
0x005	SPI_PRODIDH	[7:0]	PROD_ID[15:8]		Product ID.	0x0	R
0x006	SPI_CHIPGRADE	[7:4]	PROD_GRADE		Product grade.	0x0	R
		[3:0]	DEV_REVISION		Device revision.	0x0	R
0x020	IRQ_ENABLE	[7:5]	RESERVED		Reserved.	0x0	R
		4	EN_SYSREF_JITTER		Enable SYSREF± jitter interrupt. 0 Disable interrupt. 1 Enable interrupt.	0x0	R/W
		3	EN_DATA_READY		Enable JESD204x receiver ready (JRX_DATA_READY) low interrupt. 0 Disable interrupt. 1 Enable interrupt.	0x0	R/W
		2	EN_LANE_FIFO		Enable lane FIFO overflow/underflow interrupt. 0 Disable interrupt. 1 Enable interrupt.	0x0	R/W
		1	EN_PRBSQ		Enable PRBS imaginary error interrupt. 0 Disable interrupt. 1 Enable interrupt.	0x0	R/W
		0	EN_PRBSI		Enable PRBS real error interrupt. 0 Disable interrupt. 1 Enable interrupt.	0x0	R/W
0x024	IRQ_STATUS	[7:5]	RESERVED		Reserved.	0x0	R
		4	IRQ_SYSREF_JITTER		SYSREF± jitter is too big. Writing 1 clears the status.	0x0	R/W
		3	IRQ_DATA_READY		JRX_DATA_READY is low. Writing 1 clears the status. 0 No warning. 1 Warning detected.	0x0	R/W
		2	IRQ_LANE_FIFO		Lane FIFO overflow/underflow. Writing 1 clears the status. 0 No warning. 1 Warning detected.	0x0	R/W
		1	IRQ_PRBSQ		PRBS imaginary error. Writing 1 clears the status. 0 No warning. 1 Warning detected.	0x0	R/W
		0	IRQ_PRBSI		PRBS real error. Writing 1 clears the status. 0 No warning. 1 Warning detected.	0x0	R/W
0x031	SYNC_LMFC_DELAY_FRAME	[7:5]	RESERVED		Reserved.	0x0	R
		[4:0]	SYNC_LMFC_DELAY_SET_FRM		Desired delay from rising edge of SYSREF± input to rising edge of LMFC in frames.	0x0	R/W
0x032	SYNC_LMFC_DELAY0	[7:0]	SYNC_LMFC_DELAY_SET[7:0]		Desired delay from rising edge of SYSREF± input to rising edge of LMFC in DAC clock units.	0x0	R/W
0x033	SYNC_LMFC_DELAY1	[7:4]	RESERVED		Reserved.	0x0	R
		[3:0]	SYNC_LMFC_DELAY_SET[11:8]		Desired delay from rising edge of SYSREF± input to rising edge of LMFC in DAC clock units.	0x0	R/W

Hex. Addr.	Name	Bits	Bit Name	Settings	Description	Reset	Access
0x034	SYNC_LMFC_STAT0	[7:0]	SYNC_LMFC_DELAY_STAT[7:0]		Measured delay from rising edge of SYSREF± input to rising edge of LMFC in DAC clock units (note: 2 LSBs are always zero). A write to SYNC_LMFC_STATx or SYSREF_PHASEx saves the data for readback.	0x0	R/W
0x035	SYNC_LMFC_STAT1	[7:4]	RESERVED		Reserved.	0x0	R
		[3:0]	SYNC_LMFC_DELAY_STAT[11:8]		Measured delay from rising edge of SYSREF± input to rising edge of LMFC in DAC clock units (note: 2 LSBs are always zero). A write to SYNC_LMFC_STATx or SYSREF_PHASEx saves the data for readback.	0x0	R/W
0x036	SYSREF_COUNT	[7:0]	SYSREF_COUNT		Count of SYSREF± signals received. A write resets the count. A write to SYNC_LMFC_STATx or SYSREF_PHASEx saves the data for readback.	0x0	R/W
0x037	SYSREF_PHASE0	[7:0]	SYSREF_PHASE[7:0]		Phase of measured SYSREF± event. Thermometer encoded. A write to SYNC_LMFC_STATx or SYSREF_PHASEx saves the data for readback.	0x0	R/W
0x038	SYSREF_PHASE1	[7:4]	RESERVED		Reserved.	0x0	R
		[3:0]	SYSREF_PHASE[11:8]		Phase of measured SYSREF± event. Thermometer encoded. A write to SYNC_LMFC_STATx or SYSREF_PHASEx saves the data for readback.	0x0	R/W
0x039	SYSREF_JITTER_WINDOW	[7:6]	RESERVED		Reserved.	0x0	R
		[5:0]	SYSREF_JITTER_WINDOW		Amount of jitter allowed on the SYSREF± input. SYSREF± jitter variations bigger than this triggers an interrupt. Units are in DAC clocks. The bottom two bits are ignored.	0x0	R/W
0x03A	SYNC_CTRL	[7:2]	RESERVED		Reserved.	0x0	R
		[1:0]	SYNC_MODE		Synchronization mode. 00 Do not perform synchronization, monitor SYSREF± to LMFC delay only. 01 Perform continuous synchronization of LMFC on every SYSREF±. 10 Perform a single synchronization on the next SYSREF±, then switch to monitor mode.	0x0	R/W
0x03F	TX_ENABLE	7	SPI_DATAPATH_POST		SPI control of the data at the output of the datapath.	0x1	R/W
						0 Disable or zero the data from the datapath into the DAC. 1 Use the data from the datapath to drive the DAC.	
		6	SPI_DATAPATH_PRE		SPI control of the data at the input of the datapath. 0 Disable or zero the data feeding into the datapath. 1 Use the data from the JESD204B lanes to drive into the datapath.	0x1	R/W

Hex. Addr.	Name	Bits	Bit Name	Settings	Description	Reset	Access																																
		[5:4]	RESERVED		Reserved.	0x0	R																																
		3	TXEN_NCO_RESET		Allows TX_ENABLE to control the DDS NCO reset. 0 Use the SPI (HOPF_MODE SPI bits) to control the DDS NCO reset. 1 Use the TX_ENABLE pin to control the DDS NCO reset.	0x0	R/W																																
		2	TXEN_DATAPATH_POST		Allows TX_ENABLE to control the data at the output of the datapath. 0 Use the SPI (Bit SPI_DATAPATH_POST) for control. 1 Use the TX_ENABLE pin for control.	0x0	R/W																																
		1	TXEN_DATAPATH_PRE		Allows TX_ENABLE to control the data at the input of the datapath. 0 Use the SPI (Bit SPI_DATAPATH_PRE) for control. 1 Use the TX_ENABLE pin for control.	0x0	R/W																																
		0	TXEN_DAC_FSC		Allows TX_ENABLE to control the DAC full-scale current. 0 Use the SPI registers, ANA_FSC0 and ANA_FSC1, for control. 1 Use the TX_ENABLE pin for control.	0x0	R/W																																
0x040	ANA_DAC_BIAS_PD	[7:2]	RESERVED		Reserved.	0x0	R																																
		1	ANA_DAC_BIAS_PD1		Powers down the DAC core bias circuits. A 1 powers down the DAC core bias circuits.	0x1	R/W																																
		0	ANA_DAC_BIAS_PD0		Powers down the DAC core bias circuits. A 1 powers down the DAC core bias circuits.	0x1	R/W																																
0x041	ANA_FSC0	[7:2]	RESERVED		Reserved.	0x0	R																																
		[1:0]	ANA_FULL_SCALE_CURRENT[1:0]		DAC full-scale current. Analog full-scale current adjustment.	0x3	R/W																																
0x042	ANA_FSC1	[7:0]	ANA_FULL_SCALE_CURRENT[9:2]		DAC full-scale current. Analog full-scale current adjustment.	0xFF	R/W																																
0x07F	CLK_PHASE_TUNE	[7:6]	RESERVED		Reserved.	0x0	R																																
		[5:0]	CLK_PHASE_TUNE		Fine tuning of the clock input phase balance. Adds small capacitors to the CLK+/CLK- inputs, ~20 fF per step, signed magnitude.	0x0	R/W																																
					<table border="1"> <thead> <tr> <th rowspan="2">Bits[5:0]</th> <th colspan="2">Capacitance</th> </tr> <tr> <th>At CLK+</th> <th>At CLK-</th> </tr> </thead> <tbody> <tr> <td>000000</td> <td>0</td> <td>0</td> </tr> <tr> <td>000001</td> <td>1</td> <td>0</td> </tr> <tr> <td>000010</td> <td>2</td> <td>0</td> </tr> <tr> <td>...</td> <td>...</td> <td>...</td> </tr> <tr> <td>011111</td> <td>31</td> <td>0</td> </tr> <tr> <td>100000</td> <td>0</td> <td>0</td> </tr> <tr> <td>100001</td> <td>0</td> <td>1</td> </tr> <tr> <td>100010</td> <td>0</td> <td>2</td> </tr> <tr> <td>111111</td> <td>0</td> <td>31</td> </tr> </tbody> </table>	Bits[5:0]	Capacitance		At CLK+	At CLK-	000000	0	0	000001	1	0	000010	2	0	011111	31	0	100000	0	0	100001	0	1	100010	0	2	111111	0	31		
Bits[5:0]	Capacitance																																						
	At CLK+	At CLK-																																					
000000	0	0																																					
000001	1	0																																					
000010	2	0																																					
...																																					
011111	31	0																																					
100000	0	0																																					
100001	0	1																																					
100010	0	2																																					
111111	0	31																																					

Hex. Addr.	Name	Bits	Bit Name	Settings	Description	Reset	Access	
0x080	CLK_PD	[7:1]	RESERVED		Reserved.	0x0	R	
		0	DACCLK_PD	0 1	DAC clock power-down. Powers down the DAC clock circuitry. Power up. Power down.	0x1	R/W	
0x082	CLK_DUTY	7	CLK_DUTY_EN		Enable duty cycle control.	0x1	R/W	
		6	CLK_DUTY_OFFSET_EN		Enable duty cycle offset.	0x0	R/W	
		5	CLK_DUTY_BOOST_EN		Enable duty cycle range boost. Extends range to $\pm 5\%$ at cost of 1 dB to 2 dB worse phase noise.	0x0	R/W	
		[4:0]	CLK_DUTY_PRG		Program the duty cycle offset. 5-bit signed magnitude field, with the MSB as the sign bit and the four LSBs as the magnitude from 0 to 15. A larger magnitude skews duty cycle to a greater amount. Range is $\pm 3\%$.	0x0	R/W	
0x083	CLK_CRS_CTRL	7	CLK_CRS_EN		Enable clock cross control adjustment.	0x1	R/W	
		[6:4]	RESERVED		Reserved.	0x0	R	
		[3:0]	CLK_CRS_ADJ		Program the clock crossing point.	0x0	R/W	
0x084	PLL_REF_CLK_PD	[7:6]	RESERVED		Reserved.	0x0	R	
		[5:4]	PLL_REF_CLK_RATE	00 01 10 11	PLL reference clock rate multiplier. Normal rate (1x) PLL reference clock. Double rate (2x) PLL reference clock. Quadruple rate (4x) PLL reference clock. Disable the PLL reference clock.	0x0	R/W	
		[3:1]	RESERVED		Reserved.	0x0	R	
		0	PLL_REF_CLK_PD	0 1	PLL reference clock power-down. Enable the PLL reference clock. Power down the PLL reference clock.	0x0	R/W	
0x088	SYSREF_CTRL0	[7:4]	RESERVED		Reserved.	0x0	R	
		3	HYS_ON		SYSREF \pm hysteresis enable. This bit enables the programmable hysteresis control for the SYSREF \pm receiver.	0x0	R/W	
		2	SYSREF_RISE		Use SYSREF \pm rising edge.	0x0	R/W	
		[1:0]	HYS_CNTRL[9:8]		Controls the amount of hysteresis in the SYSREF \pm receiver. Each of the 10 bits adds 10 mV of differential hysteresis to the receiver input.	0x0	R/W	
0x089	SYSREF_CTRL1	[7:0]	HYS_CNTRL[7:0]		Controls the amount of hysteresis in the SYSREF \pm receiver. Each of the 10 bits adds 10 mV of differential hysteresis to the receiver input.	0x0	R/W	
0x090	DLL_PD	[7:5]	RESERVED		Reserved.	0x0	R	
		4	DLL_FINE_DC_EN		Fine delay line duty cycle correction enable.	0x1	R/W	
		3	DLL_FINE_XC_EN		Fine delay line cross control enable.	0x1	R/W	
		2	DLL_COARSE_DC_EN		Coarse delay line duty cycle correction enable.	0x1	R/W	
		1	DLL_COARSE_XC_EN		Coarse delay line cross control enable.	0x1	R/W	

Hex. Addr.	Name	Bits	Bit Name	Settings	Description	Reset	Access
		0	DLL_CLK_PD		Power down DLL and digital clock generator. 0 Power up DLL controller. 1 Power down DLL controller.	0x1	R/W
0x091	DLL_CTRL	7	DLL_TRACK_ERR		Track error behavior. 0 Continue on error. 1 Restart on error.	0x1	R/W
		6	DLL_SEARCH_ERR		Search error behavior. 0 Stop on error. 1 Retry on error.	0x1	R/W
		5	DLL_SLOPE		Desired slope. 0 Negative slope. 1 Positive slope.	0x1	R/W
		[4:3]	DLL_SEARCH		Search direction. 00 Search down from initial point only. 01 Search up from initial point only. 10 Search up and down from initial point.	0x2	R/W
		[2:1]	DLL_MODE		Controller mode. 00 Search then track. 01 Track only. 10 Search only.	0x0	R/W
		0	DLL_ENABLE		Controller enable. 0 Disable DLL controller: use static SPI settings. 1 Enable DLL controller: use controller with feedback loop.	0x0	R/W
0x092	DLL_STATUS	[7:3]	RESERVED		Reserved.	0x0	R
		2	DLL_FAIL		The DAC clock DLL failed to lock.	0x0	R
		1	DLL_LOST		The DAC clock DLL has lost lock.	0x0	R/W
		0	DLL_LOCKED		The DAC clock DLL has achieved lock.	0x0	R
0x093	DLL_GB	[7:4]	RESERVED		Reserved.	0x0	R
		[3:0]	DLL_GUARD		Search guard band.	0x0	R/W
0x094	DLL_COARSE	[7:6]	RESERVED		Reserved.	0x0	R
		[5:0]	DLL_COARSE		Coarse delay line setpoint.	0x0	R/W
0x095	DLL_FINE	[7:0]	DLL_FINE		Fine delay line setpoint.	0x80	R/W
0x096	DLL_PHASE	[7:5]	RESERVED		Reserved.	0x0	R
		[4:0]	DLL_PHS		Desired phase. 0 Minimum allowed phase. 16 Maximum allowed phase.	0x8	R/W
0x097	DLL_BW	[7:5]	RESERVED		Reserved.	0x0	R
		[4:2]	DLL_FILT_BW		Phase measurement filter bandwidth.	0x0	R/W
		[1:0]	DLL_WEIGHT		Tracking speed.	0x0	R/W
0x098	DLL_READ	[7:1]	RESERVED		Reserved.	0x0	R
		0	DLL_READ		Read request: 0 to 1 transition updates the coarse, fine, and phase readback values.	0x0	R/W
0x099	DLL_COARSE_RB	[7:6]	RESERVED		Reserved.	0x0	R
		[5:0]	DLL_COARSE_RB		Coarse delay line readback.	0x0	R
0x09A	DLL_FINE_RB	[7:0]	DLL_FINE_RB		Fine delay line readback.	0x0	R
0x09B	DLL_PHASE_RB	[7:5]	RESERVED		Reserved.	0x0	R
		[4:0]	DLL_PHS_RB		Phase readback.	0x0	R

Hex. Addr.	Name	Bits	Bit Name	Settings	Description	Reset	Access
0x09D	DIG_CLK_INVERT	[7:3]	RESERVED		Reserved.	0x0	R
		2	INV_DIG_CLK	0 1	Invert digital clock from DLL. Normal polarity. Inverted polarity.	0x0	R/W
		1	DIG_CLK_DC_EN		Digital clock duty cycle correction enable.	0x1	R/W
		0	DIG_CLK_XC_EN		Digital clock cross control enable.	0x1	R/W
0x0A0	DLL_CLK_DEBUG	7	DLL_TEST_EN		DLL clock output test enable.	0x0	R/W
		[6:2]	RESERVED		Reserved.	0x0	R
		[1:0]	DLL_TEST_DIV		DLL clock output divide.	0x0	R/W
0x110	INTERP_MODE	[7:4]	JESD_LANES		Number of JESD204B lanes. For proper operation of the JESD204B data link, this signal must only be programmed while the QBD is held in soft reset (Register 0x475, Bit 3), and must not be changed during normal operation.	0x8	R/W
		[3:0]	INTERP_MODE	0000 0001 0010 0011 0100 0101 0110 0111 1000	Interpolation mode. For proper operation of the JESD204B data link, this signal must only be programmed while the QBD is held in soft reset (Register 0x475, Bit 3), and must not be changed during normal operation. Reserved. Reserved. Reserved. Reserved. 6x. 8x. 12x. 16x. 24x.	0x1	R/W
0x111	DATAPATH_CFG	7	INVSINC_EN	0 1	Inverse sinc filter enable. Disable inverse sinc filter. Enable inverse sinc filter.	0x0	R/W
		6	NCO_EN	0 1	Modulation enable. Disable NCO. Enable NCO.	0x0	R/W
		5	RESERVED		Reserved.	0x0	R
		4	FILT_BW	0 1	Datapath filter bandwidth. Filter bandwidth is 80%. Filter bandwidth is 90%.	0x0	R/W
		3	RESERVED		Reserved.	0x0	R
		2	MODULUS_EN	0 1	Modulus DDS enable Disable modulus DDS. Enable modulus DDS.	0x0	R/W
		1	SEL_SIDE BAND	0 1	Selects upper or lower sideband from modulation result. Use upper sideband. Use lower sideband = spectral flip.	0x0	R/W
		0	FIR85_FILT_EN		FIR85 filter enable.	0x0	R/W

Hex. Addr.	Name	Bits	Bit Name	Settings	Description	Reset	Access
0x113	FTW_UPDATE	7	RESERVED		Reserved.	0x0	R
		[6:4]	FTW_REQ_MODE		Frequency tuning word automatic update mode. 000 No automatic requests are generated when the FTW registers are written. 001 Automatically generate FTW_LOAD_REQ after FTW0 is written. 010 Automatically generate FTW_LOAD_REQ after FTW1 is written. 011 Automatically generate FTW_LOAD_REQ after FTW2 is written. 100 Automatically generate FTW_LOAD_REQ after FTW3 is written. 101 Automatically generate FTW_LOAD_REQ after FTW4 is written. 110 Automatically generate FTW_LOAD_REQ after FTW5 is written.	0x0	R/W
		3	RESERVED		Reserved.	0x0	R
		2	FTW_LOAD_SYSREF		FTW load and reset from rising edge of SYSREF±.	0x0	R/W
		1	FTW_LOAD_ACK		Frequency tuning word update acknowledge. 0 FTW is not loaded. 1 FTW is loaded.	0x0	R
		0	FTW_LOAD_REQ		Frequency tuning word update request from SPI. 0 Clear FTW_LOAD_ACK. 1 0 to 1 transition loads the FTW.	0x0	R/W
0x114	FTW0	[7:0]	FTW[7:0]		NCO frequency tuning word. This is X in the equation $f_{OUT} = f_{DAC} \times (M/N) = f_{DAC} \times ((X + A/B)/2^{48})$.	0x0	R/W
0x115	FTW1	[7:0]	FTW[15:8]		NCO frequency tuning word. This is X in the equation $f_{OUT} = f_{DAC} \times (M/N) = f_{DAC} \times ((X + A/B)/2^{48})$.	0x0	R/W
0x116	FTW2	[7:0]	FTW[23:16]		NCO frequency tuning word. This is X in the equation $f_{OUT} = f_{DAC} \times (M/N) = f_{DAC} \times ((X + A/B)/2^{48})$.	0x0	R/W
0x117	FTW3	[7:0]	FTW[31:24]		NCO frequency tuning word. This is X in the equation $f_{OUT} = f_{DAC} \times (M/N) = f_{DAC} \times ((X + A/B)/2^{48})$.	0x0	R/W
0x118	FTW4	[7:0]	FTW[39:32]		NCO frequency tuning word. This is X in the equation $f_{OUT} = f_{DAC} \times (M/N) = f_{DAC} \times ((X + A/B)/2^{48})$.	0x0	R/W
0x119	FTW5	[7:0]	FTW[47:40]		NCO frequency tuning word. This is X in the equation $f_{OUT} = f_{DAC} \times (M/N) = f_{DAC} \times ((X + A/B)/2^{48})$.	0x0	R/W
0x11C	PHASE_OFFSET0	[7:0]	NCO_PHASE_OFFSET[7:0]		NCO phase offset.	0x0	R/W
0x11D	PHASE_OFFSET1	[7:0]	NCO_PHASE_OFFSET[15:8]		NCO phase offset.	0x0	R/W
0x124	ACC_MODULUS0	[7:0]	ACC_MODULUS[7:0]		DDS modulus. This is B in the equation $f_{OUT} = f_{DAC} \times (M/N) = f_{DAC} \times ((X + A/B)/2^{48})$. Note this modulus value is used for all NCO FTWs.	0x0	R/W

Hex. Addr.	Name	Bits	Bit Name	Settings	Description	Reset	Access
0x125	ACC_MODULUS1	[7:0]	ACC_MODULUS[15:8]		DDS modulus. This is B in the equation $f_{OUT} = f_{DAC} \times (M/N) = f_{DAC} \times ((X + A/B)/2^{48})$. Note this modulus value is used for all NCO FTWs.	0x0	R/W
0x126	ACC_MODULUS2	[7:0]	ACC_MODULUS[23:16]		DDS modulus. This is B in the equation $f_{OUT} = f_{DAC} \times (M/N) = f_{DAC} \times ((X + A/B)/2^{48})$. Note this modulus value is used for all NCO FTWs.	0x0	R/W
0x127	ACC_MODULUS3	[7:0]	ACC_MODULUS[31:24]		DDS modulus. This is B in the equation $f_{OUT} = f_{DAC} \times (M/N) = f_{DAC} \times ((X + A/B)/2^{48})$. Note this modulus value is used for all NCO FTWs.	0x0	R/W
0x128	ACC_MODULUS4	[7:0]	ACC_MODULUS[39:32]		DDS modulus. This is B in the equation $f_{OUT} = f_{DAC} \times (M/N) = f_{DAC} \times ((X + A/B)/2^{48})$. Note this modulus value is used for all NCO FTWs.	0x0	R/W
0x129	ACC_MODULUS5	[7:0]	ACC_MODULUS[47:40]		DDS modulus. This is B in the equation $f_{OUT} = f_{DAC} \times (M/N) = f_{DAC} \times ((X + A/B)/2^{48})$. Note this modulus value is used for all NCO FTWs.	0x0	R/W
0x12A	ACC_DELTA0	[7:0]	ACC_DELTA[7:0]		DDS delta. This is A in the equation $f_{OUT} = f_{DAC} \times (M/N) = f_{DAC} \times ((X + A/B)/2^{48})$. Note this modulus value is used for all NCO FTWs. Note this delta value is used for all NCO FTWs.	0x0	R/W
0x12B	ACC_DELTA1	[7:0]	ACC_DELTA[15:8]		DDS delta. This is A in the equation $f_{OUT} = f_{DAC} \times (M/N) = f_{DAC} \times ((X + A/B)/2^{48})$. Note this modulus value is used for all NCO FTWs. Note this delta value is used for all NCO FTWs.	0x0	R/W
0x12C	ACC_DELTA2	[7:0]	ACC_DELTA[23:16]		DDS delta. This is A in the equation $f_{OUT} = f_{DAC} \times (M/N) = f_{DAC} \times ((X + A/B)/2^{48})$. Note this modulus value is used for all NCO FTWs. Note this delta value is used for all NCO FTWs.	0x0	R/W
0x12D	ACC_DELTA3	[7:0]	ACC_DELTA[31:24]		DDS delta. This is A in the equation $f_{OUT} = f_{DAC} \times (M/N) = f_{DAC} \times ((X + A/B)/2^{48})$. Note this delta value is used for all NCO FTWs.	0x0	R/W
0x12E	ACC_DELTA4	[7:0]	ACC_DELTA[39:32]		DDS delta. This is A in the equation $f_{OUT} = f_{DAC} \times (M/N) = f_{DAC} \times ((X + A/B)/2^{48})$. Note this modulus value is used for all NCO FTWs. Note this delta value is used for all NCO FTWs.	0x0	R/W
0x12F	ACC_DELTA5	[7:0]	ACC_DELTA[47:40]		DDS delta. This is A in the equation $f_{OUT} = f_{DAC} \times (M/N) = f_{DAC} \times ((X + A/B)/2^{48})$. Note this modulus value is used for all NCO FTWs. Note this delta value is used for all NCO FTWs.	0x0	R/W
0x132	TEMP_SENS_LSB	[7:0]	TEMP_SENS_OUT[7:0]		Output of the temperature sensor ADC.	0x0	R
0x133	TEMP_SENS_MSB	[7:0]	TEMP_SENS_OUT[15:8]		Output of the temperature sensor ADC.	0x0	R
0x134	TEMP_SENS_UPDATE	[7:1]	RESERVED		Reserved.	0x0	R
		0	TEMP_SENS_UPDATE		Set to 1 to update the temperature sensor reading with a new value.	0x0	R/W
0x135	TEMP_SENS_CTRL	7	TEMP_SENS_FAST		A 1 sets the temperature sensor digital filter bandwidth wider for faster settling time.	0x0	R/W
		[6:1]	RESERVED		Reserved.	0x10	R/W
		0	TEMP_SENS_ENABLE		Set to 1 to enable the temperature sensor.	0x0	R/W

Hex. Addr.	Name	Bits	Bit Name	Settings	Description	Reset	Access		
0x14B	PRBS	7	PRBS_GOOD_Q		Good data indicator imaginary channel. 0 Incorrect sequence detected. 1 Correct PRBS sequence detected.	0x0	R		
		6	PRBS_GOOD_I		Good data indicator real channel. 0 Incorrect sequence detected. 1 Correct PRBS sequence detected.	0x0	R		
		5	RESERVED		Reserved.	0x0	R		
		4	PRBS_INV_Q		Data inversion imaginary channel. 0 Expect normal data. 1 Expect inverted data.	0x1	R/W		
		3	PRBS_INV_I		Data inversion real channel. 0 Expect normal data. 1 Expect inverted data.	0x0	R/W		
		2	PRBS_MODE		Polynomial select. 0 7-bit: $x^7 + x^6 + 1$. 1 15-bit: $x^{15} + x^{14} + 1$.	0x0	R/W		
		1	PRBS_RESET		Reset error counters. 0 Normal operation. 1 Reset counters.	0x0	R/W		
		0	PRBS_EN		Enable PRBS checker. 0 Disable. 1 Enable.	0x0	R/W		
		0x14C	PRBS_ERROR_I	[7:0]	PRBS_COUNT_I		Error count value real channel.	0x0	R
		0x14D	PRBS_ERROR_Q	[7:0]	PRBS_COUNT_Q		Error count value imaginary channel.	0x0	R
0x151	DECODE_CTRL	[7:3]	RESERVED		Reserved.	0x0	R/W		
		2	SHUFFLE		Shuffle mode. Enables shuffle mode for better spurious performance. 0 Disable MSB shuffling (use thermometer encoding). 1 Enable MSB shuffling.	0x0	R/W		
		[1:0]	RESERVED		Reserved.	0x0	R/W		
0x152	DECODE_MODE	[7:2]	RESERVED		Reserved.	0x0	R		
		[1:0]	DECODE_MODE		Decode mode. 00 Nonreturn-to-zero mode (first Nyquist). 01 Mix-Mode (second Nyquist). 10 Return to zero. 11 Reserved.	0x0	R/W		
0x1DF	SPI_STRENGTH	[7:4]	RESERVED		Reserved.	0x0	R		
		[3:0]	SPIDRV		Slew and drive strength for CMOS SPI outputs. Slew = Bits[1:0], drive = Bits[3:2].	0xF	R/W		
0x200	MASTER_PD	[7:1]	RESERVED		Reserved.	0x0	R		
		0	SPI_PD_MASTER		Power down the entire JESD204B Rx analog (all eight channels and bias).	0x1	R/W		
0x201	PHY_PD	[7:0]	SPI_PD_PHY		SPI override to power down the individual PHYs. Bit 0 controls the SERDINO± PHY. Bit 1 controls the SERDIN1± PHY. Bit 2 controls the SERDIN2± PHY.	0x0	R/W		

Hex. Addr.	Name	Bits	Bit Name	Settings	Description	Reset	Access
					Bit 3 controls the SERDIN3± PHY. Bit 4 controls the SERDIN4± PHY. Bit 5 controls the SERDIN5± PHY. Bit 6 controls the SERDIN6± PHY. Bit 7 controls the SERDIN7± PHY.		
0x203	GENERIC_PD	[7:2]	RESERVED		Reserved.	0x0	R
		1	SPI_SYNC1_PD		Power down LVDS buffer for the sync request signal, SYNCOUT.	0x0	R/W
		0	RESERVED		Reserved.	0x0	R/W
0x206	CDR_RESET	[7:1]	RESERVED		Reserved.	0x0	R
		0	SPI_CDR_RESET		Resets the digital control logic for all PHYs. 0 CDR logic is reset. 1 CDR logic is operational.	0x1	R/W
0x230	CDR_OPERATING_MODE_REG_0	[7:6]	RESERVED		Reserved.	0x1	R/W
		5	SPI_ENHALFRATE		Enables half rate CDR operation, must be enabled for data rates above 6 Gbps. 0 Disables CDR half rate operation, data rate ≤ 6 Gbps. 1 Enables CDR half rate operation, data rate > 6 Gbps.	0x1	R/W
		[4:3]	RESERVED		Reserved.	0x0	R/W
		[2:1]	SPI_DIVISION_RATE		Enables oversampling of the input data. 00 No division. Data rate > 3 Gbps. 01 Division by 2. 1.5 Gbps < data rate ≤ 3 Gbps. 10 Division by 4. 750 Mbps < data rate ≤ 1.5 Gbps.	0x0	R/W
		0	RESERVED		Reserved.	0x0	R/W
0x250	EQ_CONFIG_PHY_0_1	[7:4]	SPI_EQ_CONFIG1		Manual mode (SPI configured values used). 0001 Boost level = 1. 0010 Boost level = 2. 0011 Boost level = 3. 0100 Boost level = 4. 0101 Boost level = 5. 0110 Boost level = 6. 0111 Boost level = 7. 1000 Boost level = 8. 1001 Boost level = 9. 1010 Boost level = 10. 1011 Boost level = 11. 1100 Boost level = 12. 1101 Boost level = 13. 1110 Boost level = 14. 1111 Boost level = 15.	0x8	R/W
		[3:0]	SPI_EQ_CONFIG0		Manual mode (SPI configured values used). 0001 Boost level = 1. 0010 Boost level = 2. 0011 Boost level = 3.	0x8	R/W

Hex. Addr.	Name	Bits	Bit Name	Settings	Description	Reset	Access
				0100 0101 0110 0111 1000 1001 1010 1011 1100 1101 1110 1111	Boost level = 4. Boost level = 5. Boost level = 6. Boost level = 7. Boost level = 8. Boost level = 9. Boost level = 10. Boost level = 11. Boost level = 12. Boost level = 13. Boost level = 14. Boost level = 15.		
0x251	EQ_CONFIG_PHY_2_3	[7:4]	SPI_EQ_CONFIG3	0000 0001 0010 0011 0100 0101 0110 0111 1000 1001 1010 1011 1100 1101 1110 1111	Manual mode (SPI configured values used). Boost level = 1. Boost level = 2. Boost level = 3. Boost level = 4. Boost level = 5. Boost level = 6. Boost level = 7. Boost level = 8. Boost level = 9. Boost level = 10. Boost level = 11. Boost level = 12. Boost level = 13. Boost level = 14. Boost level = 15.	0x8	R/W
		[3:0]	SPI_EQ_CONFIG2	0000 0001 0010 0011 0100 0101 0110 0111 1000 1001 1010 1011 1100 1101 1110 1111	Manual mode (SPI configured values used). Boost level = 1. Boost level = 2. Boost level = 3. Boost level = 4. Boost level = 5. Boost level = 6. Boost level = 7. Boost level = 8. Boost level = 9. Boost level = 10. Boost level = 11. Boost level = 12. Boost level = 13. Boost level = 14. Boost level = 15.	0x8	R/W
0x252	EQ_CONFIG_PHY_4_5	[7:4]	SPI_EQ_CONFIG5	0000 0001 0010 0011	Manual mode (SPI configured values used). Boost level = 1. Boost level = 2. Boost level = 3.	0x8	R/W

Hex. Addr.	Name	Bits	Bit Name	Settings	Description	Reset	Access
				0100 0101 0110 0111 1000 1001 1010 1011 1100 1101 1110 1111	Boost level = 4. Boost level = 5. Boost level = 6. Boost level = 7. Boost level = 8. Boost level = 9. Boost level = 10. Boost level = 11. Boost level = 12. Boost level = 13. Boost level = 14. Boost level = 15.		
		[3:0]	SPI_EQ_CONFIG4	0000 0001 0010 0011 0100 0101 0110 0111 1000 1001 1010 1011 1100 1101 1110 1111	Manual mode (SPI configured values used). Boost level = 1. Boost level = 2. Boost level = 3. Boost level = 4. Boost level = 5. Boost level = 6. Boost level = 7. Boost level = 8. Boost level = 9. Boost level = 10. Boost level = 11. Boost level = 12. Boost level = 13. Boost level = 14. Boost level = 15.	0x8	R/W
0x253	EQ_CONFIG_PHY_6_7	[7:4]	SPI_EQ_CONFIG7	0000 0001 0010 0011 0100 0101 0110 0111 1000 1001 1010 1011 1100 1101 1110 1111	Manual mode (SPI configured values used). Boost level = 1. Boost level = 2. Boost level = 3. Boost level = 4. Boost level = 5. Boost level = 6. Boost level = 7. Boost level = 8. Boost level = 9. Boost level = 10. Boost level = 11. Boost level = 12. Boost level = 13. Boost level = 14. Boost level = 15.	0x8	R/W
		[3:0]	SPI_EQ_CONFIG6	0000 0001 0010 0011	Manual mode (SPI configured values used). Boost level = 1. Boost level = 2. Boost level = 3.	0x8	R/W

Hex. Addr.	Name	Bits	Bit Name	Settings	Description	Reset	Access
				0100 0101 0110 0111 1000 1001 1010 1011 1100 1101 1110 1111	Boost level = 4. Boost level = 5. Boost level = 6. Boost level = 7. Boost level = 8. Boost level = 9. Boost level = 10. Boost level = 11. Boost level = 12. Boost level = 13. Boost level = 14. Boost level = 15.		
0x268	EQ_BIAS_REG	[7:6]	EQ_POWER_MODE	00 01	Controls the equalizer power mode/insertion loss capability. Normal mode. Low power mode.	0x1	R/W
		[5:0]	RESERVED		Reserved.	0x4	R/W
0x280	SYNTH_ENABLE_CNTRL	[7:3]	RESERVED		Reserved.	0x0	R
		2	SPI_RECAL_SYNTH		Set this bit high to rerun all of the SERDES PLL calibration routines. Set this bit low again to allow additional recalibrations. Rising edge causes the calibration.	0x0	R/W
		1	RESERVED		Reserved.	0x0	R/W
		0	SPI_ENABLE_SYNTH		Enable the SERDES PLL. Setting this bit turns on all currents and proceeds to calibrate the PLL. Make sure reference clock and division ratios are correct before enabling this bit.	0x0	R/W
0x281	PLL_STATUS	[7:6]	RESERVED		Reserved.	0x0	R
		5	SPI_CP_OVER_RANGE_HIGH_RB	0 1	If set, the SERDES PLL CP output is above valid operating range. Charge pump output is within operating range. Charge pump output is above operating range.	0x0	R
		4	SPI_CP_OVER_RANGE_LOW_RB	0 1	If set, the SERDES PLL CP output is below valid operating range. Charge pump output is within operating range. Charge pump output is below operating range.	0x0	R
		3	SPI_CP_CAL_VALID_RB	0 1	This bit tells the user if the charge pump calibration has completed and is valid. Charge pump calibration is not valid. Charge pump calibration is valid.	0x0	R
		[2:1]	RESERVED		Reserved.	0x0	R
		0	SPI_PLL_LOCK_RB	0 1	If set, the SERDES synthesizer locked. PLL is not locked. PLL is locked.	0x0	R

Hex. Addr.	Name	Bits	Bit Name	Settings	Description	Reset	Access
0x289	REF_CLK_DIVIDER_LDO	[7:2]	RESERVED		Reserved.	0x0	R
		[1:0]	SERDES_PLL_DIV_FACTOR		SERDES PLL reference clock division factor. This field controls the division of the SERDES PLL reference clock before it is fed into the SERDES PLL PFD. It must be set so that $f_{REF}/DivFactor$ is between 35 MHz and 80 MHz. 00 Divide by 4 for lane rate between 6 Gbps and 12.5 Gbps. 01 Divide by 2 for lane rate between 3 Gbps and 6 Gbps. 10 Divide by 1 for lane rate between 1.5 Gbps and 3 Gbps.	0x0	R/W
0x2A7	TERM_BLK1_CTRLREG0	[7:1]	RESERVED		Reserved.	0x0	R
		0	SPI_I_TUNE_R_CAL_TERMBLK1		Rising edge of this bit starts a termination calibration routine.	0x0	R/W
0x2A8	TERM_BLK1_CTRLREG1	[7:0]	SPI_I_SERIALIZER_RTRIM_TERMBLK1		SPI override for termination value for PHY 0, PHY 1, PHY 6, and PHY 7. Value options are as follows: XXX0XXXX Automatically calibrate termination value. XXX1000X Force 000 as termination value. XXX1001X Force 001 as termination value. XXX1010X Force 010 as termination value. XXX1011X Force 011 as termination value. XXX1100X Force 100 as termination value. XXX1101X Force 101 as termination value. XXX1110X Force 110 as termination value. XXX1111X Force 111 as termination value. XXX1000X Force 000 as termination value.	0x0	R/W
0x2AC	TERM_BLK1_RD_REG0	[7:4]	RESERVED		Reserved.	0x0	R
		[3:0]	SPI_O_RCAL_CODE_TERMBLK1		Readback of calibration code for PHY 0, PHY 1, PHY 6, and PHY 7.	0x0	R
0x2AE	TERM_BLK2_CTRLREG0	[7:1]	RESERVED		Reserved.	0x0	R
		0	SPI_I_TUNE_R_CAL_TERMBLK2		Rising edge of this bit starts a termination calibration routine.	0x0	R/W
0x2AF	TERM_BLK2_CTRLREG1	[7:0]	SPI_I_SERIALIZER_RTRIM_TERMBLK2		SPI override for termination value for PHY 2, PHY 3, PHY 4, and PHY 5. Value options are as follows: XXX0XXXX Automatically calibrate termination value. XXX1000X Force 000 as termination value. XXX1001X Force 001 as termination value. XXX1010X Force 010 as termination value. XXX1011X Force 011 as termination value. XXX1100X Force 100 as termination value. XXX1101X Force 101 as termination value. XXX1110X Force 110 as termination value. XXX1111X Force 111 as termination value. XXX1000X Force 000 as termination value.	0x0	R/W
0x2B3	TERM_BLK2_RD_REG0	[7:4]	RESERVED		Reserved.	0x0	R
		[3:0]	SPI_O_RCAL_CODE_TERMBLK2		Readback of calibration code for PHY 2, PHY 3, PHY 4, and PHY 5.	0x0	R

Hex. Addr.	Name	Bits	Bit Name	Settings	Description	Reset	Access
0x2BB	TERM_OFFSET_0	[7:4]	RESERVED		Reserved.	0x0	R
		[3:0]	TERM_OFFSET_0		Add or subtract from the termination calibration value of Physical Lane 0. 4-bit signed magnitude value that adds to or subtracts from the termination value. Bit 3 is the sign bit, and Bits[2:0] are the magnitude bits.	0x0	R/W
0x2BC	TERM_OFFSET_1	[7:4]	RESERVED		Reserved.	0x0	R
		[3:0]	TERM_OFFSET_1		Add or subtract from the termination calibration value of Physical Lane 1. 4-bit signed magnitude value that adds to or subtracts from the termination value. Bit 3 is the sign bit, and Bits[2:0] are the magnitude bits.	0x0	R/W
0x2BD	TERM_OFFSET_2	[7:4]	RESERVED		Reserved.	0x0	R
		[3:0]	TERM_OFFSET_2		Add or subtract from the termination calibration value of Physical Lane 2. 4-bit signed magnitude value that adds to or subtracts from the termination value. Bit 3 is the sign bit, and Bits[2:0] are the magnitude bits.	0x0	R/W
0x2BE	TERM_OFFSET_3	[7:4]	RESERVED		Reserved.	0x0	R
		[3:0]	TERM_OFFSET_3		Add or subtract from the termination calibration value of Physical Lane 3. 4-bit signed magnitude value that adds to or subtracts from the termination value. Bit 3 is the sign bit, and Bits[2:0] are the magnitude bits.	0x0	R/W
0x2BF	TERM_OFFSET_4	[7:4]	RESERVED		Reserved.	0x0	R
		[3:0]	TERM_OFFSET_4		Add or subtract from the termination calibration value of Physical Lane 4. 4-bit signed magnitude value that adds to or subtracts from the termination value. Bit 3 is the sign bit, and Bits[2:0] are the magnitude bits.	0x0	R/W
0x2C0	TERM_OFFSET_5	[7:4]	RESERVED		Reserved.	0x0	R
		[3:0]	TERM_OFFSET_5		Add or subtract from the termination calibration value of Physical Lane 5. 4-bit signed magnitude value that adds to or subtracts from the termination value. Bit 3 is the sign bit, and Bits[2:0] are the magnitude bits.	0x0	R/W
0x2C1	TERM_OFFSET_6	[7:4]	RESERVED		Reserved.	0x0	R
		[3:0]	TERM_OFFSET_6		Add or subtract from the termination calibration value of Physical Lane 6. 4-bit signed magnitude value that adds to or subtracts from the termination value. Bit 3 is the sign bit, and Bits[2:0] are the magnitude bits.	0x0	R/W
0x2C2	TERM_OFFSET_7	[7:4]	RESERVED		Reserved.	0x0	R
		[3:0]	TERM_OFFSET_7		Add or subtract from the termination calibration value of Physical Lane 7. 4-bit signed magnitude value that adds to or subtracts from the termination value. Bit 3 is the sign bit, and Bits[2:0] are the magnitude bits.	0x0	R/W

Hex. Addr.	Name	Bits	Bit Name	Settings	Description	Reset	Access
0x300	GENERAL_JRX_CTRL_0	7	RESERVED		Reserved.	0x0	R
		6	CHECKSUM_MODE	0 1	JESD204B link parameter checksum calculation method. 0 Checksum is sum of fields. 1 Checksum is sum of octets.	0x0	R/W
		[5:1]	RESERVED		Reserved.	0x0	R
		0	LINK_EN		This bit brings up the JESD204B receiver when all link parameters are programmed and all clocks are ready.	0x0	R/W
0x302	DYN_LINK_LATENCY_0	[7:5]	RESERVED		Reserved.	0x0	R
		[4:0]	DYN_LINK_LATENCY_0		Measurement of the JESD204B link delay (in PCLK units). Link 0 dynamic link latency. Latency between current deframer LMFC and the global LMFC.	0x0	R
0x304	LMFC_DELAY_0	[7:5]	RESERVED		Reserved.	0x0	R
		[4:0]	LMFC_DELAY_0		Fixed part of the JESD204B link delay (in PCLK units). Delay in frame clock cycles for global LMFC for Link 0.	0x0	R/W
0x306	LMFC_VAR_0	[7:5]	RESERVED		Reserved.	0x0	R
		[4:0]	LMFC_VAR_0		Variable part of the JESD204B link delay (in PCLK units). Location in Rx LMFC where JESD204B words are read out from buffer. This setting must not be more than 10 PCLKs.	0x1F	R/W
0x308	XBAR_LN_0_1	[7:6]	RESERVED		Reserved.	0x0	R
		[5:3]	SRC_LANE1	000 001 010 011 100 101 110 111	Select data from SERDIN0±, SERDIN1±, ..., or SERDIN7± for Logic Lane 1. 000 Data is from SERDIN0±. 001 Data is from SERDIN1±. 010 Data is from SERDIN2±. 011 Data is from SERDIN3±. 100 Data is from SERDIN4±. 101 Data is from SERDIN5±. 110 Data is from SERDIN6±. 111 Data is from SERDIN7±.	0x1	R/W
0x309	XBAR_LN_2_3	[7:6]	RESERVED		Reserved.	0x0	R
		[5:3]	SRC_LANE3	000 001 010 011	Select data from SERDIN0±, SERDIN1±, ..., or SERDIN7± for Logic Lane 3. 000 Data is from SERDIN0±. 001 Data is from SERDIN1±. 010 Data is from SERDIN2±. 011 Data is from SERDIN3±.	0x3	R/W

Hex. Addr.	Name	Bits	Bit Name	Settings	Description	Reset	Access
				100	Data is from SERDIN4±.		
				101	Data is from SERDIN5±.		
				110	Data is from SERDIN6±.		
				111	Data is from SERDIN7±.		
		[2:0]	SRC_LANE2		Select data from SERDIN0±, SERDIN1±, ..., or SERDIN7± for Logic Lane 2.	0x2	R/W
				000	Data is from SERDIN0±.		
				001	Data is from SERDIN1±.		
				010	Data is from SERDIN2±.		
				011	Data is from SERDIN3±.		
				100	Data is from SERDIN4±.		
				101	Data is from SERDIN5±.		
				110	Data is from SERDIN6±.		
				111	Data is from SERDIN7±.		
0x30A	XBAR_LN_4_5	[7:6]	RESERVED		Reserved.	0x0	R
		[5:3]	SRC_LANE5		Select data from SERDIN0±, SERDIN1±, ..., or SERDIN7± for Logic Lane 5.	0x5	R/W
				000	Data is from SERDIN0±.		
				001	Data is from SERDIN1±.		
				010	Data is from SERDIN2±.		
				011	Data is from SERDIN3±.		
				100	Data is from SERDIN4±.		
				101	Data is from SERDIN5±.		
				110	Data is from SERDIN6±.		
				111	Data is from SERDIN7±.		
		[2:0]	SRC_LANE4		Select data from SERDIN0±, SERDIN1±, ..., or SERDIN7± for Logic Lane 4.	0x4	R/W
				000	Data is from SERDIN0±.		
				001	Data is from SERDIN1±.		
				010	Data is from SERDIN2±.		
				011	Data is from SERDIN3±.		
				100	Data is from SERDIN4±.		
				101	Data is from SERDIN5±.		
				110	Data is from SERDIN6±.		
				111	Data is from SERDIN7±.		
0x30B	XBAR_LN_6_7	[7:6]	RESERVED		Reserved.	0x0	R
		[5:3]	SRC_LANE7		Select data from SERDIN0±, SERDIN1±, ..., or SERDIN7± for Logic Lane 7.	0x7	R/W
				000	Data is from SERDIN0±.		
				001	Data is from SERDIN1±.		
				010	Data is from SERDIN2±.		
				011	Data is from SERDIN3±.		
				100	Data is from SERDIN4±.		
				101	Data is from SERDIN5±.		
				110	Data is from SERDIN6±.		
				111	Data is from SERDIN7±.		
		[2:0]	SRC_LANE6		Select data from SERDIN0±, SERDIN1±, ..., or SERDIN7± for Logic Lane 6.	0x6	R/W
				000	Data is from SERDIN0±.		
				001	Data is from SERDIN1±.		

Hex. Addr.	Name	Bits	Bit Name	Settings	Description	Reset	Access
				010 011 100 101 110 111	Data is from SERDIN2±. Data is from SERDIN3±. Data is from SERDIN4±. Data is from SERDIN5±. Data is from SERDIN6±. Data is from SERDIN7±.		
0x30C	FIFO_STATUS_REG_0	[7:0]	LANE_FIFO_FULL		Bit 0 corresponds to FIFO full flag for data from SERDIN0±. Bit 1 corresponds to FIFO full flag for data from SERDIN1±. Bit 2 corresponds to FIFO full flag for data from SERDIN2±. Bit 3 corresponds to FIFO full flag for data from SERDIN3±. Bit 4 corresponds to FIFO full flag for data from SERDIN4±. Bit 5 corresponds to FIFO full flag for data from SERDIN5±. Bit 6 corresponds to FIFO full flag for data from SERDIN6±. Bit 7 corresponds to FIFO full flag for data from SERDIN7±.	0x0	R
0x30D	FIFO_STATUS_REG_1	[7:0]	LANE_FIFO_EMPTY		Bit 0 corresponds to FIFO empty flag for data from SERDIN0±. Bit 1 corresponds to FIFO empty flag for data from SERDIN1±. Bit 2 corresponds to FIFO empty flag for data from SERDIN2±. Bit 3 corresponds to FIFO empty flag for data from SERDIN3±. Bit 4 corresponds to FIFO empty flag for data from SERDIN4±. Bit 5 corresponds to FIFO empty flag for data from SERDIN5±. Bit 6 corresponds to FIFO empty flag for data from SERDIN6±. Bit 7 corresponds to FIFO empty flag for data from SERDIN7±.	0x0	R
0x311	SYNC_GEN_0	[7:3]	RESERVED		Reserved.	0x0	R
		2	EOMF_MASK_0		Mask EOMF from QBD_0. Assert SYNCOUT based on loss of multiframe sync. 0 Do not assert SYNCOUT on loss of multiframe. 1 Assert SYNCOUT on loss of multiframe.	0x0	R/W
		1	RESERVED		Reserved.	0x0	R/W
		0	EOF_MASK_0		Mask EOF from QBD_0. Assert SYNCOUT based on loss of frame sync. 0 Do not assert SYNCOUT on loss of frame. 1 Assert SYNCOUT on loss of frame.	0x0	R/W

Hex. Addr.	Name	Bits	Bit Name	Settings	Description	Reset	Access
0x312	SYNC_GEN_1	[7:4]	SYNC_ERR_DUR		Duration of SYNCOUT signal low for purpose of sync error report. 0 means half PCLK cycle. Add an additional PCLK = 4 octets for each increment of the value.	0x0	R/W
		[3:0]	SYNC_SYNCREQ_DUR		Duration of SYNCOUT signal low for purpose of sync request. 0 means 5 frame + 9 octets. Add an additional PCLK = 4 octets for each increment of the value.	0x0	R/W
0x313	SYNC_GEN_3	[7:0]	LMFC_PERIOD		LMFC period in PCLK cycle. This is to report the global LMFC period based on PCLK.	0x0	R
0x315	PHY_PRBS_TEST_EN	[7:0]	PHY_TEST_EN		Enable PHY BER by ungating the clocks. 1 PHY test enable. 0 PHY test disable.	0x0	R/W
0x316	PHY_PRBS_TEST_CTRL	7	RESERVED		Reserved.	0x0	R
		[6:4]	PHY_SRC_ERR_CNT		Report Lane 0 error count. 001 Report Lane 1 error count. 010 Report Lane 2 error count. 011 Report Lane 3 error count. 100 Report Lane 4 error count. 101 Report Lane 5 error count. 110 Report Lane 6 error count. 111 Report Lane 7 error count.	0x0	R/W
		[3:2]	PHY_PRBS_PAT_SEL		Select PRBS pattern for PHY BER test. 00 PRBS7. 01 PRBS15. 10 PRBS31. 11 Not used.	0x0	R/W
		1	PHY_TEST_START		Start and stop the PHY PRBS test. 0 Test not started. 1 Test started.	0x0	R/W
		0	PHY_TEST_RESET		Reset PHY PRBS test state machine and error counters. 0 Not reset. 1 Reset.	0x0	R/W
0x317	PHY_PRBS_TEST_THRESHOLD_LOBITS	[7:0]	PHY_PRBS_THRESHOLD_LOBITS		Bits[7:0] of the 24-bit threshold value set the error flag for PHY PRBS test.	0x0	R/W
0x318	PHY_PRBS_TEST_THRESHOLD_MIDBITS	[7:0]	PHY_PRBS_THRESHOLD_MIDBITS		Bits[15:8] of the 24-bit threshold value set the error flag for PHY PRBS test.	0x0	R/W
0x319	PHY_PRBS_TEST_THRESHOLD_HIBITS	[7:0]	PHY_PRBS_THRESHOLD_HIBITS		Bits[23:16] of the 24-bit threshold value set the error flag for PHY PRBS test.	0x0	R/W
0x31A	PHY_PRBS_TEST_ERRCNT_LOBITS	[7:0]	PHY_PRBS_ERR_CNT_LOBITS		Bits[7:0] of the 24-bit reported PHY BER test error count from selected lane.	0x0	R
0x31B	PHY_PRBS_TEST_ERRCNT_MIDBITS	[7:0]	PHY_PRBS_ERR_CNT_MIDBITS		Bits[15:8] of the 24-bit reported PHY BER test error count from selected lane.	0x0	R
0x31C	PHY_PRBS_TEST_ERRCNT_HIBITS	[7:0]	PHY_PRBS_ERR_CNT_HIBITS		Bits[23:16] of the 24-bit reported PHY BER test error count from selected lane.	0x0	R

Hex. Addr.	Name	Bits	Bit Name	Settings	Description	Reset	Access
0x31D	PHY_PRBS_TEST_STATUS	[7:0]	PHY_PRBS_PASS		Each bit is for the corresponding lane. Report PHY BER test pass/fail for each lane.	0xFF	R
0x31E	PHY_DATA_SNAPSHOT_CTRL	[7:5]	RESERVED		Reserved.	0x0	R
		[4:2]	PHY_GRAB_LANE_SEL		Select which lane to grab data.	0x0	R/W
				000	Grab data from Lane 0.		
				001	Grab data from Lane 1.		
010	Grab data from Lane 2.						
				011	Grab data from Lane 3.		
				100	Grab data from Lane 4.		
				101	Grab data from Lane 5.		
				110	Grab data from Lane 6.		
				111	Grab data from Lane 7.		
		1	PHY_GRAB_MODE		Use error trigger to grab data.	0x0	R/W
				0	Grab data when PHY_GRAB_DATA is set.		
				1	Grab data upon bit error.		
		0	PHY_GRAB_DATA		Transition from 0 to 1 causes logic to store current receive data from one lane.	0x0	R/W
0x31F	PHY_SNAPSHOT_DATA_BYTE0	[7:0]	PHY_SNAPSHOT_DATA_BYTE0		Current data received represents PHY_SNAPSHOT_DATA[7:0].	0x0	R
0x320	PHY_SNAPSHOT_DATA_BYTE1	[7:0]	PHY_SNAPSHOT_DATA_BYTE1		Current data received represents PHY_SNAPSHOT_DATA[15:8].	0x0	R
0x321	PHY_SNAPSHOT_DATA_BYTE2	[7:0]	PHY_SNAPSHOT_DATA_BYTE2		Current data received represents PHY_SNAPSHOT_DATA[23:16].	0x0	R
0x322	PHY_SNAPSHOT_DATA_BYTE3	[7:0]	PHY_SNAPSHOT_DATA_BYTE3		Current data received represents PHY_SNAPSHOT_DATA[31:24].	0x0	R
0x323	PHY_SNAPSHOT_DATA_BYTE4	[7:0]	PHY_SNAPSHOT_DATA_BYTE4		Current data received represents PHY_SNAPSHOT_DATA[39:32].	0x0	R
0x32C	SHORT_TPL_TEST_0	[7:4]	SHORT_TPL_SP_SEL		Short transport layer sample selection. Select which sample to check from a specific DAC.	0x0	R/W
				0000	Sample 0.		
				0001	Sample 1.		
				0010	Sample 2.		
				0011	Sample 3.		
				0100	Sample 4.		
				0101	Sample 5.		
				0110	Sample 6.		
				0111	Sample 7.		
				1000	Sample 8.		
				1001	Sample 9.		
				1010	Sample 10.		
				1011	Sample 11.		
				1100	Sample 12.		
				1101	Sample 13.		
				1110	Sample 14.		
				1111	Sample 15.		
		[3:2]	SHORT_TPL_M_SEL		Short transport layer test DAC selection. Select which DAC to check.	0x0	R/W
				00	DAC 0.		
				01	DAC 1.		
				10	DAC 2.		
				11	DAC 3.		

Hex. Addr.	Name	Bits	Bit Name	Settings	Description	Reset	Access
		1	SHORT_TPL_TEST_RESET		Short transport layer test reset. Resets the result of short transport layer test. 0 Not reset. 1 Reset.	0x0	R/W
		0	SHORT_TPL_TEST_EN		Short transport layer test enable. Enable short transport layer test. 0 Disable. 1 Enable.	0x0	R/W
0x32D	SHORT_TPL_TEST_1	[7:0]	SHORT_TPL_REF_SP_LSB		Short transport layer reference sample LSB. This is the lower eight bits of expected DAC sample. It is used to compare with the received DAC sample at the output of JESD204B Rx.	0x0	R/W
0x32E	SHORT_TPL_TEST_2	[7:0]	SHORT_TPL_REF_SP_MSB		Short transport layer test reference sample MSB. This is the upper eight bits of expected DAC sample. It is used to compare with the received sample at JESD204B Rx output.	0x0	R/W
0x32F	SHORT_TPL_TEST_3	[7:1]	RESERVED		Reserved.	0x0	R
		0	SHORT_TPL_FAIL		Short transport layer test fail. This bit shows if the selected DAC sample matches the reference sample. If they match, the test passes; otherwise, the test fails. 0 Test pass. 1 Test fail.	0x0	R
0x334	JESD_BIT_INVERSE_CTRL	[7:0]	JESD_BIT_INVERSE		Each bit of this byte inverts the JESD204B deserialized data from one specific JESD204B Rx PHY. The bit order matches the logical lane order. For example, Bit 0 controls Lane 0, Bit 1 controls Lane 1.	0x0	R/W
0x400	DID_REG	[7:0]	DID_RD		Received ILAS configuration on Lane 0. DID is the device ID number. Link information received on Lane 0 as specified in Section 8.3 of JESD204B.	0x0	R
0x401	BID_REG	[7:0]	BID_RD		Received ILAS configuration on Lane 0. BID is the bank ID, extension to DID. Link information received on Lane 0 as specified in Section 8.3 of JESD204B.	0x0	R
0x402	LIDO_REG	7	RESERVED		Reserved.	0x0	R
		6	ADJDIR_RD		Received ILAS configuration on Lane 0. ADJDIR is the direction to adjust the DAC LMFC. Link information received on Lane 0 as specified in Section 8.3 of JESD204B.	0x0	R
		5	PHADJ_RD		Received ILAS configuration on Lane 0. PHADJ is the phase adjustment request to DAC. Link information received on Lane 0 as specified in Section 8.3 of JESD204B.	0x0	R
		[4:0]	LL_LIDO		Received ILAS LID configuration on Lane 0. LIDO is the lane identification for Lane 0. Link information received on Lane 0 as specified in Section 8.3 of JESD204B.	0x0	R

Hex. Addr.	Name	Bits	Bit Name	Settings	Description	Reset	Access			
0x403	SCR_L_REG	7	SCR_RD		Received ILAS configuration on Lane 0. SCR is the Tx scrambling status. Link information received on Lane 0 as specified in Section 8.3 of JESD204B.	0x0	R			
				0	Scrambling is disabled.					
				1	Scrambling is enabled.					
				[6:5]	RESERVED			Reserved.	0x0	R
	[4:0]	L_RD		Received ILAS configuration on Lane 0. L is the number of lanes per converter device. Link information received on Lane 0 as specified in Section 8.3 of JESD204B.	0x0	R				
0000	1 lane per converter device.									
0001	2 lanes per converter device.									
0011	4 lanes per converter device.									
				00111	8 lanes per converter device.					
0x404	F_REG	[7:0]	F_RD		Received ILAS configuration on Lane 0. F is the number of octets per frame. Settings of 1, 2, and 4 are valid (value in register is F – 1). Link information received on Lane 0 as specified in Section 8.3 of JESD204B.	0x0	R			
				0	1 octet per frame.					
				1	2 octets per frame.					
				11	4 octets per frame.					
0x405	K_REG	[7:5]	RESERVED		Reserved.	0x0	R			
			[4:0]	K_RD				Received ILAS configuration on Lane 0. K is the number of frames per multiframe. Settings of 16 or 32 are valid. On this device, all modes use K = 32 (value in register is K – 1). Link information received on Lane 0 as specified in Section 8.3 of JESD204B.		
				01111	16 frames per multiframe.					
				11111	32 frames per multiframe.					
0x406	M_REG	[7:0]	M_RD		Received ILAS configuration on Lane 0. M is the number of converters per device. Link information received on Lane 0 as specified in Section 8.3 of JESD204B. M is 1 for real interface and 2 for complex interface (value in register is M – 1).	0x0	R			
0x407	CS_N_REG	[7:6]	CS_RD		Received ILAS configuration on Lane 0. CS is the number of control bits per sample. Link information received on Lane 0 as specified in Section 8.3 of JESD204B. CS is always 0 on this device.	0x0	R			
				5	RESERVED			Reserved.	0x0	R
				[4:0]	N_RD				Received ILAS configuration on Lane 0. N is the converter resolution. Value in register is N – 1 (for example, 16 bits = 0b01111).	0x0

Hex. Addr.	Name	Bits	Bit Name	Settings	Description	Reset	Access
0x408	NP_REG	[7:5]	SUBCLASSV_RD	000 001	Received ILAS configuration on Lane 0. SUBCLASSV is the device subclass version. Link information received on Lane 0 as specified in Section 8.3 of JESD204B. Subclass 0. Subclass 1.	0x0	R
		[4:0]	NP_RD		Received ILAS configuration on Lane 0. NP is the total number of bits per sample. Link information received on Lane 0 as specified in Section 8.3 of JESD204B. Value in register is NP – 1, for example, 16 bits per sample = 0b01111.	0x0	R
0x409	S_REG	[7:5]	JESDV_RD	000 001	Received ILAS configuration on Lane 0. JESDV is the JESD204x version. Link information received on Lane 0 as specified in Section 8.3 of JESD204B. JESD204A. JESD204B.	0x0	R
		[4:0]	S_RD		Received ILAS configuration on Lane 0. S is the number of samples per converter per frame cycle. Link information received on Lane 0 as specified in Section 8.3 of JESD204B. Value in register is S – 1.	0x0	R
0x40A	HD_CF_REG	7	HD_RD	0 1	Received ILAS configuration on Lane 0. HD is the high density format. Refer to Section 5.1.3 of JESD204B standard. Link information received on Lane 0 as specified in Section 8.3 of JESD204B. Low density mode. High density mode.	0x0	R
		[6:5]	RESERVED		Reserved.	0x0	R
		[4:0]	CF_RD		Received ILAS configuration on Lane 0. CF is the number of control words per frame clock period per link. Link information received on Lane 0 as specified in Section 8.3 of JESD204B. CF is always 0 on this device.	0x0	R
0x40B	RES1_REG	[7:0]	RES1_RD		Received ILAS configuration on Lane 0. Reserved Field 1. Link information received on Lane 0 as specified in Section 8.3 of JESD204B.	0x0	R
0x40C	RES2_REG	[7:0]	RES2_RD		Received ILAS configuration on Lane 0. Reserved Field 2. Link information received on Lane 0 as specified in Section 8.3 of JESD204B.	0x0	R
0x40D	CHECKSUM0_REG	[7:0]	LL_FCHK0		Received checksum during ILAS on Lane 0. Checksum for Lane 0. Link information received on Lane 0 as specified in Section 8.3 of JESD204B.	0x0	R

Hex. Addr.	Name	Bits	Bit Name	Settings	Description	Reset	Access
0x40E	COMPNUM0_REG	[7:0]	LL_FCMP0		Computed checksum on Lane 0. Computed checksum for Lane 0. The JESD204B Rx computes the checksum of the link information received on Lane 0 as specified in Section 8.3 of JESD204B. The computation method is set by the CHECKSUM_MODE bit (Register 0x300, Bit 6) and must match the likewise calculated checksum in Register 0x40D.	0x0	R
0x412	LID1_REG	[7:5]	RESERVED		Reserved.	0x0	R
		[4:0]	LL_LID1		Received ILAS LID configuration on Lane 1. Lane identification for Lane 1. Link information received on Lane 0 as specified in Section 8.3 of JESD204B.	0x0	R
0x415	CHECKSUM1_REG	[7:0]	LL_FCHK1		Received checksum during ILAS on lane 1. Checksum for Lane 1. Link information received on Lane 0 as specified in Section 8.3 of JESD204B.	0x0	R
0x416	COMPNUM1_REG	[7:0]	LL_FCMP1		Computed checksum on Lane 1. Computed checksum for Lane 1 (see description for Register 0x40E).	0x0	R
0x41A	LID2_REG	[7:5]	RESERVED		Reserved.	0x0	R
		[4:0]	LL_LID2		Received ILAS LID configuration on Lane 2. Lane identification for Lane 2.	0x0	R
0x41D	CHECKSUM2_REG	[7:0]	LL_FCHK2		Received checksum during ILAS on Lane 2. Checksum for Lane 2.	0x0	R
0x41E	COMPNUM2_REG	[7:0]	LL_FCMP2		Computed checksum on Lane 2. Computed checksum for Lane 2 (see description for Register 0x40E).	0x0	R
0x422	LID3_REG	[7:5]	RESERVED		Reserved.	0x0	R
		[4:0]	LL_LID3		Received ILAS LID configuration on Lane 3. Lane identification for Lane 3.	0x0	R
0x425	CHECKSUM3_REG	[7:0]	LL_FCHK3		Received checksum during ILAS on Lane 3. Checksum for Lane 3.	0x0	R
0x426	COMPNUM3_REG	[7:0]	LL_FCMP3		Computed checksum on Lane 3. Computed checksum for Lane 3 (see description for Register 0x40E).	0x0	R
0x42A	LID4_REG	[7:5]	RESERVED		Reserved.	0x0	R
		[4:0]	LL_LID4		Received ILAS LID configuration on Lane 4. Lane identification for Lane 4.	0x0	R
0x42D	CHECKSUM4_REG	[7:0]	LL_FCHK4		Received checksum during ILAS on Lane 4. Checksum for Lane 4.	0x0	R
0x42E	COMPNUM4_REG	[7:0]	LL_FCMP4		Computed checksum on Lane 4. Computed checksum for Lane 4 (see description for Register 0x40E).	0x0	R
0x432	LID5_REG	[7:5]	RESERVED		Reserved.	0x0	R
		[4:0]	LL_LID5		Received ILAS LID configuration on Lane 5. Lane identification for Lane 5.	0x0	R
0x435	CHECKSUM5_REG	[7:0]	LL_FCHK5		Received checksum during ILAS on Lane 5. Checksum for Lane 5.	0x0	R
0x436	COMPNUM5_REG	[7:0]	LL_FCMP5		Computed checksum on Lane 5. Computed checksum for Lane 5 (see description for Register 0x40E).	0x0	R

Hex. Addr.	Name	Bits	Bit Name	Settings	Description	Reset	Access
0x43A	LID6_REG	[7:5]	RESERVED		Reserved.	0x0	R
		[4:0]	LL_LID6		Received ILAS LID configuration on Lane 6. Lane identification for Lane 6.	0x0	R
0x43D	CHECKSUM6_REG	[7:0]	LL_FCHK6		Received checksum during ILAS on Lane 6. Checksum for Lane 6.	0x0	R
0x43E	COMP6_REG	[7:0]	LL_FCMP6		Computed checksum on Lane 6. Computed checksum for Lane 6 (see description for Register 0x40E).	0x0	R
0x442	LID7_REG	[7:5]	RESERVED		Reserved.	0x0	R
		[4:0]	LL_LID7		Received ILAS LID configuration on Lane 7. Lane identification for Lane 7.	0x0	R
0x445	CHECKSUM7_REG	[7:0]	LL_FCHK7		Received checksum during ILAS on Lane 7. Checksum for Lane 7.	0x0	R
0x446	COMP7_REG	[7:0]	LL_FCMP7		Computed checksum on Lane 7. Computed checksum for Lane 7 (see description for Register 0x40E).	0x0	R
0x450	ILS_DID	[7:0]	DID		Device (= link) identification number. DID is the device ID number. Link information received on Lane 0 as specified in Section 8.3 of JESD204B. Must be set to the value read in Register 0x400. This signal must only be programmed while the QBD is held in soft reset (Register 0x475, Bit 3), and must not be changed during normal operation.	0x0	R/W
0x451	ILS_BID	[7:0]	BID		Bank ID, extension to DID. This signal must only be programmed while the QBD is held in soft reset (Register 0x475, Bit 3), and must not be changed during normal operation.	0x0	R/W
0x452	ILS_LID0	7	RESERVED		Reserved.	0x0	R
		6	ADJDIR		Direction to adjust DAC LMFC (Subclass 2 only). ADJDIR is the direction to adjust DAC LMFC. Link information received on Lane 0 as specified in Section 8.3 of JESD204B. This signal must only be programmed while the QBD is held in soft reset (Register 0x475, Bit 3), and must not be changed during normal operation.	0x0	R/W
		5	PHADJ		Phase adjustment to DAC (Subclass 2 only). PHADJ is the phase adjustment request to the DAC. Link information received on Lane 0 as specified in Section 8.3 of JESD204B. This signal must only be programmed while the QBD is held in soft reset (Register 0x475, Bit 3), and must not be changed during normal operation.	0x0	R/W
		[4:0]	LID0		Lane identification number (within link). LID0 is the lane identification for Lane 0. Link information received on Lane 0 as specified in Section 8.3 of JESD204B. This signal must only be programmed while the QBD is held in soft reset (Register 0x475, Bit 3), and must not be changed during normal operation.	0x0	R/W

Hex. Addr.	Name	Bits	Bit Name	Settings	Description	Reset	Access
0x453	ILS_SCR_L	7	SCR		Scramble enable. SCR is the Rx descrambling enable. This signal must only be programmed while the QBD is held in soft reset (Register 0x475, Bit 3), and must not be changed during normal operation. 0 Descrambling is disabled. 1 Descrambling is enabled.	0x1	R/W
		[6:5]	RESERVED		Reserved.	0x0	R
		[4:0]	L		Number of lanes per converter (minus 1). L is the number of lanes per converter device. Settings of 1, 2, 3, 4, 6, and 8 are valid. Refer to Table 14 and Table 15.	0x7	R
0x454	ILS_F	[7:0]	F		Number of octets per frame (minus 1). This value of F is not used to soft configure the QBD. Register CTRLREG1 is used to soft-configure the QBD.	0x0	R
0x455	ILS_K	[7:5]	RESERVED		Reserved.	0x0	R
		[4:0]	K		Number of frames per multiframe (minus 1). K is the number of frames per multiframe. On this device, all modes use K = 32 (value in register is K – 1). This signal must only be programmed while the QBD is held in soft reset (Register 0x475, Bit 3), and must not be changed during normal operation. 01111 16 frames per multiframe. 11111 32 frames per multiframe.	0x1F	R/W
0x456	ILS_M	[7:0]	M		Number of converters per device (minus 1). M is the number of converters/device. Settings of 1 and 2 are valid. Refer to Table 14 and Table 15.	0x1	R
0x457	ILS_CS_N	[7:6]	CS		Number of control bits per sample. CS is the number of control bits per sample. Must be set to 0. Control bits are not supported.	0x0	R
		5	RESERVED		Reserved.	0x0	R
		[4:0]	N		Converter resolution (minus 1). N is the converter resolution. Must be set to 16 (0x0F).	0xF	R
0x458	ILS_NP	[7:5]	SUBCLASSV		Device subclass version. SUBCLASSV is the device subclass version. This signal must only be programmed while the QBD is held in soft reset (Register 0x475, Bit 3), and must not be changed during normal operation. 000 Subclass 0. 001 Subclass 1. 010 Subclass 2 (not supported).	0x0	R/W
		[4:0]	NP		Total number of bits per sample (minus 1). NP is the total number of bits per sample. Must be set to 16 (0x0F). Refer to Table 14 and Table 15.	0xF	R

Hex. Addr.	Name	Bits	Bit Name	Settings	Description	Reset	Access
0x459	ILS_S	[7:5]	JESDV		JESD204x version. JESDV is the JESD204x version. This signal must only be programmed while the QBD is held in soft reset (Register 0x475, Bit 3), and must not be changed during normal operation.	0x0	R/W
				000	JESD204A.		
				001	JESD204B.		
		[4:0]	S		Number of samples per converter per frame cycle (minus 1). S is the number of samples per converter per frame cycle. Settings of 1 and 2 are valid. Refer to Table 14 and Table 15.	0x1	R
0x45A	ILS_HD_CF	7	HD		High density format. HD is the high density mode. Refer to Section 5.1.3 of JESD204B standard.	0x1	R
				0	Low density mode.		
				1	High density mode.		
		[6:5]	RESERVED		Reserved.	0x0	R
		[4:0]	CF		Number of control bits per sample. CF is the number of control words per frame clock period per link. Must be set to 0. Control bits are not supported.	0x0	R
0x45B	ILS_RES1	[7:0]	RES1		Reserved. Reserved Field 1. This signal must only be programmed while the QBD is held in soft reset (Register 0x475, Bit 3), and must not be changed during normal operation.	0x0	R/W
0x45C	ILS_RES2	[7:0]	RES2		Reserved. Reserved Field 2. This signal must only be programmed while the QBD is held in soft reset (Register 0x475, Bit 3), and must not be changed during normal operation.	0x0	R/W
0x45D	ILS_CHECKSUM	[7:0]	FCHK0		Link configuration checksum. Checksum for Lane 0. The checksum for the values programmed into Register 0x450 to Register 0x45C must be calculated according to Section 8.3 of the JESD204B specification and written to this register (SUM(Register 0x450 to Register 0x45C) % 256). This signal must only be programmed while the QBD is held in soft reset (Register 0x475, Bit 3), and must not be changed during normal operation.	0x0	R/W
0x46C	LANE_DESKEW	7	ILD7		Interlane deskew status for Lane 7 (ignore this output when NO_ILAS = 1).	0x0	R
				0	Deskew failed.		
				1	Deskew achieved.		
		6	ILS6		Initial lane synchronization status for Lane 6 (ignore this output when NO_ILAS = 1).	0x0	R
				0	Synchronization lost.		
				1	Synchronization achieved.		

Hex. Addr.	Name	Bits	Bit Name	Settings	Description	Reset	Access
		5	ILD5		Interlane deskew status for Lane 5 (ignore this output when NO_ILAS = 1). 0 Deskew failed. 1 Deskew achieved.	0x0	R
		4	ILD4		Interlane deskew status for Lane 4 (ignore this output when NO_ILAS = 1). 0 Deskew failed. 1 Deskew achieved.	0x0	R
		3	ILD3		Interlane deskew status for Lane 3 (ignore this output when NO_ILAS = 1). 0 Deskew failed. 1 Deskew achieved.	0x0	R
		2	ILD2		Interlane deskew status for Lane 2 (ignore this output when NO_ILAS = 1). 0 Deskew failed. 1 Deskew achieved.	0x0	R
		1	ILD1		Interlane deskew status for Lane 1 (ignore this output when NO_ILAS = 1). 0 Deskew failed. 1 Deskew achieved.	0x0	R
		0	ILD0		Interlane deskew status for Lane 0 (ignore this output when NO_ILAS = 1). 0 Deskew failed. 1 Deskew achieved.	0x0	R
0x46D	BAD_DISPARITY	7	BDE7		Bad disparity error status for Lane 7. 0 Error count < ETH[7:0] value. 1 Error count ≥ ETH[7:0] value.	0x0	R
		6	BDE6		Bad disparity error status for Lane 6. 0 Error count < ETH[7:0] value. 1 Error count ≥ ETH[7:0] value.	0x0	R
		5	BDE5		Bad disparity errors status for Lane 5. 0 Error count < ETH[7:0] value. 1 Error count ≥ ETH[7:0] value.	0x0	R
		4	BDE4		Bad disparity error status for Lane 4. 0 Error count < ETH[7:0] value. 1 Error count ≥ ETH[7:0] value.	0x0	R
		3	BDE3		Bad disparity error status for Lane 3. 0 Error count < ETH[7:0] value. 1 Error count ≥ ETH[7:0] value.	0x0	R
		2	BDE2		Bad disparity error status for Lane 2. 0 Error count < ETH[7:0] value. 1 Error count ≥ ETH[7:0] value.	0x0	R
		1	BDE1		Bad disparity error status for Lane 1. 0 Error count < ETH[7:0] value. 1 Error count ≥ ETH[7:0] value.	0x0	R
		0	BDE0		Bad disparity error status for Lane 0. 0 Error count < ETH[7:0] value. 1 Error count ≥ ETH[7:0] value.	0x0	R

Hex. Addr.	Name	Bits	Bit Name	Settings	Description	Reset	Access
0x46E	NOT_IN_TABLE	7	NIT7		Not in table error status for Lane 7. 0 Error count < ETH[7:0] value. 1 Error count ≥ ETH[7:0] value.	0x0	R
		6	NIT6		Not in table error status for Lane 6. 0 Error count < ETH[7:0] value. 1 Error count ≥ ETH[7:0] value.	0x0	R
		5	NIT5		Not in table errors status for Lane 5. 0 Error count < ETH[7:0] value. 1 Error count ≥ ETH[7:0] value.	0x0	R
		4	NIT4		Not in table error status for Lane 4. 0 Error count < ETH[7:0] value. 1 Error count ≥ ETH[7:0] value.	0x0	R
		3	NIT3		Not in table error status for Lane 3. 0 Error count < ETH[7:0] value. 1 Error count ≥ ETH[7:0] value.	0x0	R
		2	NIT2		Not in table error status for Lane 2. 0 Error count < ETH[7:0] value. 1 Error count ≥ ETH[7:0] value.	0x0	R
		1	NIT1		Not in table error status for Lane 1. 0 Error count < ETH[7:0] value. 1 Error count ≥ ETH[7:0] value.	0x0	R
		0	NIT0		Not in table error status for Lane 0. 0 Error count < ETH[7:0] value. 1 Error count ≥ ETH[7:0] value.	0x0	R
0x46F	UNEXPECTED_KCHAR	7	UEK7		Unexpected K character error status for Lane 7. 0 Error count < ETH[7:0] value. 1 Error count ≥ ETH[7:0] value.	0x0	R
		6	UEK6		Unexpected K character error status for Lane 6. 0 Error count < ETH[7:0] value. 1 Error count ≥ ETH[7:0] value.	0x0	R
		5	UEK5		Unexpected K character error status for Lane 5. 0 Error count < ETH[7:0] value. 1 Error count ≥ ETH[7:0] value.	0x0	R
		4	UEK4		Unexpected K character error status for Lane 4. 0 Error count < ETH[7:0] value. 1 Error count ≥ ETH[7:0] value.	0x0	R
		3	UEK3		Unexpected K character error status for Lane 3. 0 Error count < ETH[7:0] value. 1 Error count ≥ ETH[7:0] value.	0x0	R
		2	UEK2		Unexpected K character error status for Lane 2. 0 Error count < ETH[7:0] value. 1 Error count ≥ ETH[7:0] value.	0x0	R
		1	UEK1		Unexpected K character error status for Lane 1. 0 Error count < ETH[7:0] value. 1 Error count ≥ ETH[7:0] value.	0x0	R

Hex. Addr.	Name	Bits	Bit Name	Settings	Description	Reset	Access
		0	UEK0		Unexpected K character error status for Lane 0. 0 Error count < ETH[7:0] value. 1 Error count ≥ ETH[7:0] value.	0x0	R
0x470	CODE_GRP_SYNC	7	CGS7		Code group sync status for Lane 7. 0 Synchronization lost. 1 Synchronization achieved.	0x0	R
		6	CGS6		Code group sync status for Lane 6. 0 Synchronization lost. 1 Synchronization achieved.	0x0	R
		5	CGS5		Code group sync status for Lane 5. 0 Synchronization lost. 1 Synchronization achieved.	0x0	R
		4	CGS4		Code group sync status for Lane 4. 0 Synchronization lost. 1 Synchronization achieved.	0x0	R
		3	CGS3		Code group sync status for Lane 3. 0 Synchronization lost. 1 Synchronization achieved.	0x0	R
		2	CGS2		Code group sync status for Lane 2. 0 Synchronization lost. 1 Synchronization achieved.	0x0	R
		1	CGS1		Code group sync status for Lane 1. 0 Synchronization lost. 1 Synchronization achieved.	0x0	R
		0	CGS0		Code group sync status for Lane 0. 0 Synchronization lost. 1 Synchronization achieved.	0x0	R
0x471	FRAME_SYNC	7	FS7		Frame sync status for Lane 7 (ignore this output when NO_ILAS = 1). 0 Synchronization lost. 1 Synchronization achieved.	0x0	R
		6	FS6		Frame sync status for Lane 6 (ignore this output when NO_ILAS = 1). 0 Synchronization lost. 1 Synchronization achieved.	0x0	R
		5	FS5		Frame sync status for Lane 5 (ignore this output when NO_ILAS = 1). 0 Synchronization lost. 1 Synchronization achieved.	0x0	R
		4	FS4		Frame sync status for Lane 4 (ignore this output when NO_ILAS = 1). 0 Synchronization lost. 1 Synchronization achieved.	0x0	R
		3	FS3		Frame sync status for Lane 3 (ignore this output when NO_ILAS = 1). 0 Synchronization lost. 1 Synchronization achieved.	0x0	R

Hex. Addr.	Name	Bits	Bit Name	Settings	Description	Reset	Access
		2	FS2		Frame sync status for Lane 2 (ignore this output when NO_ILAS = 1). 0 Synchronization lost. 1 Synchronization achieved.	0x0	R
		1	FS1		Frame sync status for Lane 1 (ignore this output when NO_ILAS = 1). 0 Synchronization lost. 1 Synchronization achieved.	0x0	R
		0	FS0		Frame sync status for Lane 0 (ignore this output when NO_ILAS = 1). 0 Synchronization lost. 1 Synchronization achieved.	0x0	R
0x472	GOOD_CHECKSUM	7	CKS7		Computed checksum status for Lane 7 (ignore this output when NO_ILAS = 1). 0 Checksum is incorrect. 1 Checksum is correct.	0x0	R
		6	CKS6		Computed checksum status for Lane 6 (ignore this output when NO_ILAS = 1). 0 Checksum is incorrect. 1 Checksum is correct.	0x0	R
		5	CKS5		Computed checksum status for Lane 5 (ignore this output when NO_ILAS = 1). 0 Checksum is incorrect. 1 Checksum is correct.	0x0	R
		4	CKS4		Computed checksum status for Lane 4 (ignore this output when NO_ILAS = 1). 0 Checksum is incorrect. 1 Checksum is correct.	0x0	R
		3	CKS3		Computed checksum status for Lane 3 (ignore this output when NO_ILAS = 1). 0 Checksum is incorrect. 1 Checksum is correct.	0x0	R
		2	CKS2		Computed checksum status for Lane 2 (ignore this output when NO_ILAS = 1). 0 Checksum is incorrect. 1 Checksum is correct.	0x0	R
		1	CKS1		Computed checksum status for Lane 1 (ignore this output when NO_ILAS = 1). 0 Checksum is incorrect. 1 Checksum is correct.	0x0	R
		0	CKS0		Computed checksum status for Lane 0 (ignore this output when NO_ILAS = 1). 0 Checksum is incorrect. 1 Checksum is correct.	0x0	R

Hex. Addr.	Name	Bits	Bit Name	Settings	Description	Reset	Access
0x473	INIT_LANE_SYNC	7	ILS7		Initial lane synchronization status for Lane 7 (ignore this output when NO_ILAS = 1). 0 Synchronization lost. 1 Synchronization achieved.	0x0	R
		6	ILS6		Initial lane synchronization status for Lane 6 (ignore this output when NO_ILAS = 1). 0 Synchronization lost. 1 Synchronization achieved.	0x0	R
		5	ILS5		Initial lane synchronization status for Lane 5 (ignore this output when NO_ILAS = 1). 0 Synchronization lost. 1 Synchronization achieved.	0x0	R
		4	ILS4		Initial lane synchronization status for Lane 4 (ignore this output when NO_ILAS = 1). 0 Synchronization lost. 1 Synchronization achieved.	0x0	R
		3	ILS3		Initial lane synchronization status for Lane 3 (ignore this output when NO_ILAS = 1). 0 Synchronization lost. 1 Synchronization achieved.	0x0	R
		2	ILS2		Initial lane synchronization status for Lane 2 (ignore this output when NO_ILAS = 1). 0 Synchronization lost. 1 Synchronization achieved.	0x0	R
		1	ILS1		Initial lane synchronization status for Lane 1 (ignore this output when NO_ILAS = 1). 0 Synchronization lost. 1 Synchronization achieved.	0x0	R
		0	ILS0		Initial lane synchronization status for Lane 0 (ignore this output when NO_ILAS = 1). 0 Synchronization lost. 1 Synchronization achieved.	0x0	R
0x475	CTRLREG0	7	RX_DIS		Level input: disable deframer receiver when this input = 1. This signal must only be programmed while the QBD is held in soft reset (Register 0x475, Bit 3), and must not be changed during normal operation. 1 Disable character replacement of /A/ and /F/ control characters at the end of received frames and multiframes. 0 Enables the substitution.	0x0	R/W
		6	CHAR_REPL_DIS		When this input = 1, character replacement at the end of frame/multiframe is disabled. This signal must only be programmed while the QBD is held in soft reset (Register 0x475, Bit 3), and must not be changed during normal operation.	0x0	R/W
		[5:4]	RESERVED		Reserved.	0x0	R

Hex. Addr.	Name	Bits	Bit Name	Settings	Description	Reset	Access
		3	SOFRST		Soft reset. Active high synchronous reset. Resets all hardware to power-on state. 1 Disables the deframer reception. 0 Enable deframer logic.	0x0	R/W
		2	FORCESYNCREQ		Command from application to assert a sync request (SYNCOUT). Active high.	0x0	R/W
		1	RESERVED		Reserved.	0x0	R
		0	REPL_FRM_ENA		When this level input is set, it enables replacement of frames received in error. This signal must only be programmed while the QBD is held in soft reset (Register 0x475, Bit 3), and must not be changed during normal operation.	0x1	R/W
0x476	CTRLREG1	[7:5]	RESERVED		Reserved.	0x0	R
		4	QUAL_RDERR		Error reporting behavior for concurrent NIT and RD errors. This signal must only be programmed while the QBD is held in soft reset (Register 0x475, Bit 3), and must not be changed during normal operation. 0 NIT has no effect on RD error. 1 NIT error masks concurrent RD error.	0x1	R/W
		3	DEL_SCR		Alternative descrambler enable. (see JESD204B Section 5.2.4) This signal must only be programmed while the QBD is held in soft reset (Register 0x475, Bit 3), and must not be changed during normal operation. 1 Descrambling begins at Octet 2 of user data. 0 Descrambling begins at Octet 0 of user data. This is the common usage.	0x0	R/W
		2	CGS_SEL		Determines the QBD behavior after code group sync has been achieved. This signal must only be programmed while the QBD is held in soft reset (Register 0x475, Bit 3), and must not be changed during normal operation. 0 After code group sync is achieved, the QBD asserts SYNCOUT only if there are sufficient disparity errors as per the JESD204B standard. 1 After code group sync is achieved, if a /K/ is followed by any character other than an /R/ or another /K/, QBD asserts SYNCOUT.	0x1	R/W

Hex. Addr.	Name	Bits	Bit Name	Settings	Description	Reset	Access
		1	NO_ILAS		<p>This signal must only be programmed while the QBD is held in soft reset (Register 0x475, Bit 3), and must not be changed during normal operation.</p> <p>1 For single-lane operation, ILAS is omitted. Code group sync is followed by user data.</p> <p>0 Code group sync is followed by ILAS. For multilane operation, NO_ILAS must always be set to 0.</p>	0x0	R/W
		0	FCHK_N		<p>Checksum calculation method. This signal must only be programmed while the QBD is held in soft reset (Register 0x475, Register 3), and must not be changed during normal operation.</p> <p>0 Calculate checksum by summing individual fields (this more closely matches the definition of the checksum field in the JESD204B standard).</p> <p>1 Calculate checksum by summing the registers containing the packed fields (this setting is provided in case the framer of another vendor performs the calculation with this method).</p>	0x0	R/W
0x477	CTRLREG2	7	ILS_MODE		<p>Data link layer test mode. This signal must only be programmed while the QBD is held in soft reset (Register 0x475, Bit 3), and must not be changed during normal operation.</p> <p>0 Normal mode.</p> <p>1 Code group sync pattern is followed by a perpetual ILAS sequence.</p>	0x0	R/W
		6	RESERVED		Reserved.	0x0	R
		5	REPDATA TEST		<p>Repetitive data test enable, using JTSPAT pattern. To enable the test, ILS_MODE must = 0. This signal must only be programmed while the QBD is held in soft reset (Register 0x475, Bit 3), and must not be changed during normal operation.</p>	0x0	R/W
		4	QUETESTERR		<p>Queue test error mode. This signal must only be programmed while the QBD is held in soft reset (Register 0x475, Bit 3), and must not be changed during normal operation.</p> <p>0 Simultaneous errors on multiple lanes are reported as one error.</p> <p>1 Detected errors from all lanes are trapped in a counter and sequentially signaled on SYNCOUT.</p>	0x0	R/W

Hex. Addr.	Name	Bits	Bit Name	Settings	Description	Reset	Access
		3	AR_ECNT		Automatic reset of error counter. The error counter that causes assertion of SYNCOUT is automatically reset to 0 when AR_ECNT = 1. All other counters are unaffected. This signal must only be programmed while the QBD is held in soft reset (Register 0x475, Bit 3), and must not be changed during normal operation.	0x0	R/W
		[2:0]	RESERVED		Reserved.	0x0	R
0x478	KVAL	[7:0]	KSYNC		Number of 4 × K multiframes during ILS. F is the number of octets per frame. Settings of 1, 2, and 4 are valid. Refer to Table 14 and Table 15. This signal must only be programmed while the QBD is held in soft reset (Register 0x475, Bit 3), and must not be changed during normal operation.	0x1	R/W
0x47C	ERRORTHRES	[7:0]	ETH		Error threshold value. Bad disparity, NIT disparity, and unexpected K character errors are counted and compared to the error threshold value. When the count is equal, either an IRQ is generated or SYNCOUT± is asserted per the mask register settings or both. Function is performed in all lanes. This signal must only be programmed while the QBD is held in soft reset (Register 0x475, Bit 3), and must not be changed during normal operation.	0xFF	R/W
0x47D	SYNC_ASSERT_MASK	[7:3]	RESERVED		Reserved.	0x0	R
		[2:0]	SYNC_ASSERT_MASK		SYNCOUT assertion enable mask for BD, NIT, and UEK error conditions. Active high, SYNCOUT assertion enable mask for BD, NIT, and UEK error conditions, respectively. When an error counter, in any lane, has reached the error threshold count, ETH[7:0], and the corresponding SYNC_ASSERT_MASK bit is set, SYNCOUT is asserted. The mask bits are as follows. Note that the bit sequence is reversed with respect to the other error count controls and the error counters. Bit 2 = bad disparity error (BDE). Bit 1 = not in table error (NIT). Bit 0 = unexpected K (UEK) character error.	0x7	R/W
0x480	ECNT_CTRL0	[7:6]	RESERVED		Reserved.	0x0	R
		[5:3]	ECNT_ENA0		Error counter enable for Lane 0. Counters of each lane are addressed as follows: Bit 2 = unexpected K (UEK) character error. Bit 1 = not in table error (NIT). Bit 0 = bad disparity error (BDE).	0x7	R/W

Hex. Addr.	Name	Bits	Bit Name	Settings	Description	Reset	Access
		[2:0]	ECNT_RST0		Reset error counters for Lane 0, active high. Counters of each lane are addressed as follows: Bit 2 = unexpected K (UEK) character error. Bit 1 = not in table error (NIT). Bit 0 = bad disparity error (BDE).	0x7	R/W
0x481	ECNT_CTRL1	[7:6]	RESERVED		Reserved.	0x0	R
		[5:3]	ECNT_ENA1		Error counters enable for Lane 1, active high. Counters of each lane are addressed as follows: Bit 2 = unexpected K (UEK) character error. Bit 1 = not in table error (NIT). Bit 0 = bad disparity error (BDE).	0x7	R/W
		[2:0]	ECNT_RST1		Reset error counters for Lane 1, active high. Counters of each lane are addressed as follows: Bit 2 = unexpected K (UEK) character error. Bit 1 = not in table error (NIT). Bit 0 = bad disparity error (BDE).	0x7	R/W
0x482	ECNT_CTRL2	[7:6]	RESERVED		Reserved.	0x0	R
		[5:3]	ECNT_ENA2		Error counters enable for Lane 2, active high. Counters of each lane are addressed as follows: Bit 2 = unexpected K (UEK) character error. Bit 1 = not in table error (NIT). Bit 0 = bad disparity error (BDE).	0x7	R/W
		[2:0]	ECNT_RST2		Reset error counters for Lane 2, active high. Counters of each lane are addressed as follows: Bit 2 = unexpected K (UEK) character error. Bit 1 = not in table error (NIT). Bit 0 = bad disparity error (BDE).	0x7	R/W
0x483	ECNT_CTRL3	[7:6]	RESERVED		Reserved.	0x0	R
		[5:3]	ECNT_ENA3		Error counters enable for Lane 3, active high. Counters of each lane are addressed as follows: Bit 2 = unexpected K (UEK) character error. Bit 1 = not in table error (NIT). Bit 0 = bad disparity error (BDE).	0x7	R/W
		[2:0]	ECNT_RST3		Reset error counters for Lane 3, active high. Counters of each lane are addressed as follows: Bit 2 = unexpected K (UEK) character error. Bit 1 = not in table error (NIT). Bit 0 = bad disparity error (BDE).	0x7	R/W

Hex. Addr.	Name	Bits	Bit Name	Settings	Description	Reset	Access
0x484	ECNT_CTRL4	[7:6]	RESERVED		Reserved.	0x0	R
		[5:3]	ECNT_ENA4		Error counters enable for Lane 4, active high. Counters of each lane are addressed as follows: Bit 2 = unexpected K (UEK) character error. Bit 1 = not in table error (NIT). Bit 0 = bad disparity error (BDE).	0x7	R/W
		[2:0]	ECNT_RST4		Reset error counters for Lane 4, active high. Counters of each lane are addressed as follows: Bit 2 = unexpected K (UEK) character error. Bit 1 = not in table error (NIT). Bit 0 = bad disparity error (BDE).	0x7	R/W
0x485	ECNT_CTRL5	[7:6]	RESERVED		Reserved.	0x0	R
		[5:3]	ECNT_ENA5		Error counters enable for Lane 5, active high. Counters of each lane are addressed as follows: Bit 2 = unexpected K (UEK) character error. Bit 1 = not in table error (NIT). Bit 0 = bad disparity error (BDE).	0x7	R/W
		[2:0]	ECNT_RST5		Reset error counters for Lane 5, active high. Counters of each lane are addressed as follows: Bit 2 = unexpected K (UEK) character error. Bit 1 = not in table error (NIT). Bit 0 = bad disparity error (BDE).	0x7	R/W
0x486	ECNT_CTRL6	[7:6]	RESERVED		Reserved.	0x0	R
		[5:3]	ECNT_ENA6		Error counters enable for Lane 6, active high. Counters of each lane are addressed as follows: Bit 2 = unexpected K (UEK) character error. Bit 1 = not in table error (NIT). Bit 0 = bad disparity error (BDE).	0x7	R/W
		[2:0]	ECNT_RST6		Reset error counters for Lane 6, active high. Counters of each lane are addressed as follows: Bit 2 = unexpected K (UEK) character error. Bit 1 = not in table error (NIT). Bit 0 = bad disparity error (BDE).	0x7	R/W
0x487	ECNT_CTRL7	[7:6]	RESERVED		Reserved.	0x0	R
		[5:3]	ECNT_ENA7		Error counters enable for Lane 7, active high. Counters of each lane are addressed as follows: Bit 2 = unexpected K (UEK) character error. Bit 1 = not in table error (NIT). Bit 0 = bad disparity error (BDE).	0x7	R/W

Hex. Addr.	Name	Bits	Bit Name	Settings	Description	Reset	Access
		[2:0]	ECNT_RST7		Reset error counters for Lane 7, active high. Counters of each lane are addressed as follows: Bit 2 = unexpected K (UEK) character error. Bit 1 = not in table error (NIT). Bit 0 = bad disparity error (BDE).	0x7	R/W
0x488	ECNT_TCH0	[7:3]	RESERVED		Reserved.	0x0	R
		[2:0]	ECNT_TCH0		Terminal count hold enable of error counters for Lane 0. When set, the designated counter is to hold the terminal count value of 0xFF when it is reached until the counter is reset by the user. Otherwise, the designated counter rolls over. Counters of each lane are addressed as follows: Bit 2 = unexpected K (UEK) character error. Bit 1 = not in table error (NIT). Bit 0 = bad disparity error (BDE). This signal must only be programmed while the QBD is held in soft reset (Register 0x475, Bit 3), and must not be changed during normal operation.	0x7	R/W
0x489	ECNT_TCH1	[7:3]	RESERVED		Reserved.	0x0	R
		[2:0]	ECNT_TCH1		Terminal count hold enable of error counters for Lane 1. When set, the designated counter is to hold the terminal count value of 0xFF when it is reached until the counter is reset by the user. Otherwise, the designated counter rolls over. Counters of each lane are addressed as follows: Bit 2 = unexpected K (UEK) character error. Bit 1 = not in table error (NIT). Bit 0 = bad disparity error (BDE). This signal must only be programmed while the QBD is held in soft reset (Register 0x475, Bit 3), and must not be changed during normal operation.	0x7	R/W
0x48A	ECNT_TCH2	[7:3]	RESERVED		Reserved.	0x0	R
		[2:0]	ECNT_TCH2		Terminal count hold enable of error counters for Lane 2. When set, the designated counter is to hold the terminal count value of 0xFF when it is reached until the counter is reset by the user. Otherwise, the designated counter rolls over. Counters of each lane are addressed as follows: Bit 2 = unexpected K (UEK) character error.	0x7	R/W

Hex. Addr.	Name	Bits	Bit Name	Settings	Description	Reset	Access
					<p>Bit 1 = not in table error (NIT). Bit 0 = bad disparity error (BDE).</p> <p>This signal must only be programmed while the QBD is held in soft reset (Register 0x475, Bit 3), and must not be changed during normal operation.</p>		
0x48B	ECNT_TCH3	[7:3]	RESERVED		Reserved.	0x0	R
		[2:0]	ECNT_TCH3		<p>Terminal count hold enable of error counters for Lane 3. When set, the designated counter is to hold the terminal count value of 0xFF when it is reached until the counter is reset by the user. Otherwise, the designated counter rolls over. Counters of each lane are addressed as follows:</p> <p>Bit 2 = unexpected K (UEK) character error. Bit 1 = not in table error (NIT). Bit 0 = bad disparity error (BDE).</p> <p>This signal must only be programmed while the QBD is held in soft reset (Register 0x475, Bit 3), and must not be changed during normal operation.</p>	0x7	R/W
0x48C	ECNT_TCH4	[7:3]	RESERVED		Reserved.	0x0	R
		[2:0]	ECNT_TCH4		<p>Terminal count hold enable of error counters for Lane 4. When set, the designated counter is to hold the terminal count value of 0xFF when it is reached until the counter is reset by the user. Otherwise, the designated counter rolls over. Counters of each lane are addressed as follows:</p> <p>Bit 2 = unexpected K (UEK) character error. Bit 1 = not in table error (NIT). Bit 0 = bad disparity error (BDE).</p> <p>This signal must only be programmed while the QBD is held in soft reset (Register 0x475, Bit 3), and must not be changed during normal operation.</p>	0x7	R/W
0x48D	ECNT_TCH5	[7:3]	RESERVED		Reserved.	0x0	R
		[2:0]	ECNT_TCH5		<p>Terminal count hold enable of error counters for Lane 5. When set, the designated counter is to hold the terminal count value of 0xFF when it is reached until the counter is reset by the user. Otherwise, the designated counter rolls over. Counters of each lane are addressed as follows:</p> <p>Bit 2 = unexpected K (UEK) character error. Bit 1 = not in table error (NIT). Bit 0 = bad disparity error (BDE).</p> <p>This signal must only be programmed while the QBD is held in soft reset (Register 0x475, Bit 3), and must not be changed during normal operation.</p>	0x7	R/W

Hex. Addr.	Name	Bits	Bit Name	Settings	Description	Reset	Access
0x48E	ECNT_TCH6	[7:3]	RESERVED		Reserved.	0x0	R
		[2:0]	ECNT_TCH6		Terminal count hold enable of error counters for Lane 6. When set, the designated counter is to hold the terminal count value of 0xFF when it is reached until the counter is reset by the user. Otherwise, the designated counter rolls over. Counters of each lane are addressed as follows: Bit 2 = unexpected K (UEK) character error. Bit 1 = not in table error (NIT). Bit 0 = bad disparity error (BDE). This signal must only be programmed while the QBD is held in soft reset (Register 0x475, Bit 3), and must not be changed during normal operation.	0x7	R/W
0x48F	ECNT_TCH7	[7:3]	RESERVED		Reserved.	0x0	R
		[2:0]	ECNT_TCH7		Terminal count hold enable of error counters for Lane 7. When set, the designated counter is to hold the terminal count value of 0xFF when it is reached until the counter is reset by the user. Otherwise, the designated counter rolls over. Counters of each lane are addressed as follows: Bit 2 = unexpected K (UEK) character error. Bit 1 = not in table error (NIT). Bit 0 = bad disparity error (BDE). This signal must only be programmed while the QBD is held in soft reset (Register 0x475, Bit 3), and must not be changed during normal operation.	0x7	R/W
0x490	ECNT_STAT0	[7:4]	RESERVED		Reserved.	0x0	R
		3	LANE_ENA0		This output indicates if Lane 0 is enabled. 0 Lane 0 is held in soft reset. 1 Lane 0 is enabled.	0x0	R
		[2:0]	ECNT_TCR0		Terminal count reached indicator of error counters for Lane 0. Set to 1 when the corresponding counter terminal count value of 0xFF has been reached. Counters of each lane are addressed as follows. Bit 2 = unexpected K (UEK) character error. Bit 1 = not in table error (NIT). Bit 0 = bad disparity error (BDE).	0x0	R
0x491	ECNT_STAT1	[7:4]	RESERVED		Reserved.	0x0	R
		3	LANE_ENA1		This output indicates if Lane 1 is enabled. 0 Lane 1 is held in soft reset. 1 Lane 1 is enabled.	0x0	R

Hex. Addr.	Name	Bits	Bit Name	Settings	Description	Reset	Access
		[2:0]	ECNT_TCR1		Terminal count reached indicator of error counters for Lane 1. Set to 1 when the corresponding counter terminal count value of 0xFF has been reached. Counters of each lane are addressed as follows. Bit 2 = unexpected K (UEK) character error. Bit 1 = not in table error (NIT). Bit 0 = bad disparity error (BDE).	0x0	R
0x492	ECNT_STAT2	[7:4]	RESERVED		Reserved.	0x0	R
		3	LANE_ENA2		This output indicates if Lane 2 is enabled. 0 Lane 2 is held in soft reset. 1 Lane 2 is enabled.	0x0	R
		[2:0]	ECNT_TCR2		Terminal count reached indicator of error counters for Lane 2. Set to 1 when the corresponding counter terminal count value of 0xFF has been reached. Counters of each lane are addressed as follows. Bit 2 = unexpected K (UEK) character error. Bit 1 = not in table error (NIT). Bit 0 = bad disparity error (BDE).	0x0	R
0x493	ECNT_STAT3	[7:4]	RESERVED		Reserved.	0x0	R
		3	LANE_ENA3		This output indicates if Lane 3 is enabled. 0 Lane 3 is held in soft reset. 1 Lane 3 is enabled.	0x0	R
		[2:0]	ECNT_TCR3		Terminal count reached indicator of error counters for Lane 3. Set to 1 when the corresponding counter terminal count value of 0xFF has been reached. Counters of each lane are addressed as follows: Bit 2 = unexpected K (UEK) character error. Bit 1 = not in table error (NIT). Bit 0 = bad disparity error (BDE).	0x0	R
0x494	ECNT_STAT4	[7:4]	RESERVED		Reserved.	0x0	R
		3	LANE_ENA4		This output indicates if Lane 4 is enabled. 0 Lane 4 is held in soft reset. 1 Lane 4 is enabled.	0x0	R
		[2:0]	ECNT_TCR4		Terminal count reached indicator of error counters for Lane 4. Set to 1 when the corresponding counter terminal count value of 0xFF has been reached. Counters of each lane are addressed as follows: Bit 2 = unexpected K (UEK) character error. Bit 1 = not in table error (NIT). Bit 0 = bad disparity error (BDE).	0x0	R

Hex. Addr.	Name	Bits	Bit Name	Settings	Description	Reset	Access
0x495	ECNT_STAT5	[7:4]	RESERVED		Reserved.	0x0	R
		3	LANE_ENA5		This output indicates if Lane 5 is enabled. 0 Lane 5 is held in soft reset. 1 Lane 5 is enabled.	0x0	R
		[2:0]	ECNT_TCR5		Terminal count reached indicator of error counters for Lane 5. Set to 1 when the corresponding counter terminal count value of 0xFF has been reached. Counters of each lane are addressed as follows: Bit 2 = unexpected K (UEK) character error. Bit 1 = not in table error (NIT). Bit 0 = bad disparity error (BDE).	0x0	R
0x496	ECNT_STAT6	[7:4]	RESERVED		Reserved.	0x0	R
		3	LANE_ENA6		This output indicates if Lane 6 is enabled. 0 Lane 6 is held in soft reset. 1 Lane 6 is enabled.	0x0	R
		[2:0]	ECNT_TCR6		Terminal count reached indicator of error counters for Lane 6. Set to 1 when the corresponding counter terminal count value of 0xFF has been reached. Counters of each lane are addressed as follows: Bit 2 = unexpected K (UEK) character error. Bit 1 = not in table error (NIT). Bit 0 = bad disparity error (BDE).	0x0	R
0x497	ECNT_STAT7	[7:4]	RESERVED		Reserved.	0x0	R
		3	LANE_ENA7		This output indicates if Lane 7 is enabled. 0 Lane 7 is held in soft reset. 1 Lane 7 is enabled.	0x0	R
		[2:0]	ECNT_TCR7		Terminal count reached indicator of error counters for Lane 7. Set to 1 when the corresponding counter terminal count value of 0xFF has been reached. Counters of each lane are addressed as follows: Bit 2 = unexpected K (UEK) character error. Bit 1 = not in table error (NIT). Bit 0 = bad disparity error (BDE).	0x0	R
0x498	BD_CNT0	[7:0]	BD_CNT0		Bad disparity 8-bit error counters for Lane 0.	0x0	R
0x499	BD_CNT1	[7:0]	BD_CNT1		Bad disparity 8-bit error counters for Lane 1.	0x0	R
0x49A	BD_CNT2	[7:0]	BD_CNT2		Bad disparity 8-bit error counters for Lane 2.	0x0	R
0x49B	BD_CNT3	[7:0]	BD_CNT3		Bad disparity 8-bit error counters for Lane 3.	0x0	R
0x49C	BD_CNT4	[7:0]	BD_CNT4		Bad disparity 8-bit error counters for Lane 4.	0x0	R

Hex. Addr.	Name	Bits	Bit Name	Settings	Description	Reset	Access
0x49D	BD_CNT5	[7:0]	BD_CNT5		Bad disparity 8-bit error counters for Lane 5.	0x0	R
0x49E	BD_CNT6	[7:0]	BD_CNT6		Bad disparity 8-bit error counters for Lane 6.	0x0	R
0x49F	BD_CNT7	[7:0]	BD_CNT7		Bad disparity 8-bit error counters for Lane 7.	0x0	R
0x4A0	NIT_CNT0	[7:0]	NIT_CNT0		Not in table 8-bit error counters for Lane 0.	0x0	R
0x4A1	NIT_CNT1	[7:0]	NIT_CNT1		Not in table 8-bit error counters for Lane 1.	0x0	R
0x4A2	NIT_CNT2	[7:0]	NIT_CNT2		Not in table 8-bit error counters for Lane 2.	0x0	R
0x4A3	NIT_CNT3	[7:0]	NIT_CNT3		Not in table 8-bit error counters for Lane 3.	0x0	R
0x4A4	NIT_CNT4	[7:0]	NIT_CNT4		Not in table 8-bit error counters for Lane 4.	0x0	R
0x4A5	NIT_CNT5	[7:0]	NIT_CNT5		Not in table 8-bit error counters for Lane 5.	0x0	R
0x4A6	NIT_CNT6	[7:0]	NIT_CNT6		Not in table 8-bit error counters for Lane 6.	0x0	R
0x4A7	NIT_CNT7	[7:0]	NIT_CNT7		Not in table 8-bit error counters for Lane 7.	0x0	R
0x4A8	UEK_CNT0	[7:0]	UEK_CNT0		Unexpected K character 8-bit error counters for Lane 0.	0x0	R
0x4A9	UEK_CNT1	[7:0]	UEK_CNT1		Unexpected K character 8-bit error counters for Lane 1.	0x0	R
0x4AA	UEK_CNT2	[7:0]	UEK_CNT2		Unexpected K character 8-bit error counters for Lane 2.	0x0	R
0x4AB	UEK_CNT3	[7:0]	UEK_CNT3		Unexpected K character 8-bit error counters for Lane 3.	0x0	R
0x4AC	UEK_CNT4	[7:0]	UEK_CNT4		Unexpected K character 8-bit error counters for Lane 4.	0x0	R
0x4AD	UEK_CNT5	[7:0]	UEK_CNT5		Unexpected K character 8-bit error counters for Lane 5.	0x0	R
0x4AE	UEK_CNT6	[7:0]	UEK_CNT6		Unexpected K character 8-bit error counters for Lane 6.	0x0	R
0x4AF	UEK_CNT7	[7:0]	UEK_CNT7		Unexpected K character 8-bit error counters for Lane 7.	0x0	R
0x4B0	LINK_STATUS0	7	BDE0		Bad disparity errors status for Lane 0. 0 Error count < ETH[7:0] value. 1 Error count ≥ ETH[7:0] value.	0x0	R
		6	NIT0		Not in table errors status for Lane 0. 0 Error count < ETH[7:0] value. 1 Error count ≥ ETH[7:0] value.	0x0	R
		5	UEK0		Unexpected K character errors status for Lane 0. 0 Error count < ETH[7:0] value. 1 Error count ≥ ETH[7:0] value.	0x0	R
		4	ILD0		Interlane deskew status for Lane 0 (ignore this output when NO_ILAS = 1). 0 Deskew failed. 1 Deskew achieved.	0x0	R

Hex. Addr.	Name	Bits	Bit Name	Settings	Description	Reset	Access
		3	ILS0		Initial lane synchronization status for Lane 0 (ignore this output when NO_ILAS = 1). 0 Synchronization lost. 1 Synchronization achieved.	0x0	R
		2	CKS0		Computed checksum status for Lane 0 (ignore this output when NO_ILAS = 1). 0 Checksum is incorrect. 1 Checksum is correct.	0x0	R
		1	FS0		Frame sync status for Lane 0 (ignore this output when NO_ILAS = 1). 0 Synchronization lost. 1 Synchronization achieved.	0x0	R
		0	CGS0		Code group sync status for Lane 0. 0 Synchronization lost. 1 Synchronization achieved.	0x0	R
0x4B1	LINK_STATUS1	7	BDE1		Bad disparity errors status for Lane 1. 0 Error count < ETH[7:0] value. 1 Error count ≥ ETH[7:0] value.	0x0	R
		6	NIT1		Not in table errors status for Lane 1. 0 Error count < ETH[7:0] value. 1 Error count ≥ ETH[7:0] value.	0x0	R
		5	UEK1		Unexpected K character errors status for Lane 1. 0 Error count < ETH[7:0] value. 1 Error count ≥ ETH[7:0] value.	0x0	R
		4	ILD1		Interlane deskew status for Lane 1 (ignore this output when NO_ILAS = 1). 0 Deskew failed. 1 Deskew achieved.	0x0	R
		3	ILS1		Initial lane synchronization status for Lane 1 (ignore this output when NO_ILAS = 1). 0 Synchronization lost. 1 Synchronization achieved.	0x0	R
		2	CKS1		Computed checksum status for Lane 1 (ignore this output when NO_ILAS = 1). 0 Checksum is incorrect. 1 Checksum is correct.	0x0	R
		1	FS1		Frame sync status for Lane 1 (ignore this output when NO_ILAS = 1). 0 Synchronization lost. 1 Synchronization achieved.	0x0	R
		0	CGS1		Code group sync status for Lane 1. 0 Synchronization lost. 1 Synchronization achieved.	0x0	R
0x4B2	LINK_STATUS2	7	BDE2		Bad disparity errors status for Lane 2. 0 Error count < ETH[7:0] value. 1 Error count ≥ ETH[7:0] value.	0x0	R

Hex. Addr.	Name	Bits	Bit Name	Settings	Description	Reset	Access
		6	NIT2		Not in table errors status for Lane 2. 0 Error count < ETH[7:0] value. 1 Error count ≥ ETH[7:0] value.	0x0	R
		5	UEK2		Unexpected K character errors status for Lane 2. 0 Error count < ETH[7:0] value. 1 Error count ≥ ETH[7:0] value.	0x0	R
		4	ILD2		Interlane deskew status for Lane 2 (ignore this output when NO_ILAS = 1). 0 Deskew failed. 1 Deskew achieved.	0x0	R
		3	ILS2		Initial lane synchronization status for Lane 2 (ignore this output when NO_ILAS = 1). 0 Synchronization lost. 1 Synchronization achieved.	0x0	R
		2	CKS2		Computed checksum status for Lane 2 (ignore this output when NO_ILAS = 1). 0 Checksum is incorrect. 1 Checksum is correct.	0x0	R
		1	FS2		Frame sync status for Lane 2 (ignore this output when NO_ILAS = 1). 0 Synchronization lost. 1 Synchronization achieved.	0x0	R
		0	CGS2		Code group sync status for Lane 2. 0 Synchronization lost. 1 Synchronization achieved.	0x0	R
0x4B3	LINK_STATUS3	7	BDE3		Bad disparity errors status for Lane 3. 0 Error count < ETH[7:0] value. 1 Error count ≥ ETH[7:0] value.	0x0	R
		6	NIT3		Not in table errors status for Lane 3. 0 Error count < ETH[7:0] value. 1 Error count ≥ ETH[7:0] value.	0x0	R
		5	UEK3		Unexpected K character errors status for Lane 3. 0 Error count < ETH[7:0] value. 1 Error count ≥ ETH[7:0] value.	0x0	R
		4	ILD3		Interlane deskew status for Lane 3 (ignore this output when NO_ILAS = 1). 0 Deskew failed. 1 Deskew achieved.	0x0	R
		3	ILS3		Initial lane synchronization status for Lane 3 (ignore this output when NO_ILAS = 1). 0 Synchronization lost. 1 Synchronization achieved.	0x0	R
		2	CKS3		Computed checksum status for Lane 3 (ignore this output when NO_ILAS = 1). 0 Checksum is incorrect. 1 Checksum is correct.	0x0	R

Hex. Addr.	Name	Bits	Bit Name	Settings	Description	Reset	Access
		1	FS3		Frame sync status for Lane 3 (ignore this output when NO_ILAS = 1). 0 Synchronization lost. 1 Synchronization achieved.	0x0	R
		0	CGS3		Code group sync status for Lane 3. 0 Synchronization lost. 1 Synchronization achieved.	0x0	R
0x4B4	LINK_STATUS4	7	BDE4		Bad disparity errors status for Lane 4. 0 Error count < ETH[7:0] value. 1 Error count ≥ ETH[7:0] value.	0x0	R
		6	NIT4		Not in table errors status for Lane 4. 0 Error count < ETH[7:0] value. 1 Error count ≥ ETH[7:0] value.	0x0	R
		5	UEK4		Unexpected K character errors status for Lane 4. 0 Error count < ETH[7:0] value. 1 Error count ≥ ETH[7:0] value.	0x0	R
		4	ILD4		Interlane deskew status for Lane 4 (ignore this output when NO_ILAS = 1). 0 Deskew failed. 1 Deskew achieved.	0x0	R
		3	ILS4		Initial lane synchronization status for Lane 4 (ignore this output when NO_ILAS = 1). 0 Synchronization lost. 1 Synchronization achieved.	0x0	R
		2	CKS4		Computed checksum status for Lane 4 (ignore this output when NO_ILAS = 1). 0 Checksum is incorrect. 1 Checksum is correct.	0x0	R
		1	FS4		Frame sync status for Lane 4 (ignore this output when NO_ILAS = 1). 0 Synchronization lost. 1 Synchronization achieved.	0x0	R
		0	CGS4		Code group sync status for Lane 4. 0 Synchronization lost. 1 Synchronization achieved.	0x0	R
0x4B5	LINK_STATUS5	7	BDE5		Bad disparity errors status for Lane 5. 0 Error count < ETH[7:0] value. 1 Error count ≥ ETH[7:0] value.	0x0	R
		6	NIT5		Not in table errors status for Lane 5. 0 Error count < ETH[7:0] value. 1 Error count ≥ ETH[7:0] value.	0x0	R
		5	UEK5		Unexpected K character errors status for Lane 5. 0 Error count < ETH[7:0] value. 1 Error count ≥ ETH[7:0] value.	0x0	R

Hex. Addr.	Name	Bits	Bit Name	Settings	Description	Reset	Access
		4	ILD5		Interlane deskew status for Lane 5 (ignore this output when NO_ILAS = 1). 0 Deskew failed. 1 Deskew achieved.	0x0	R
		3	ILS5		Initial lane synchronization status for Lane 5 (ignore this output when NO_ILAS = 1). 0 Synchronization lost. 1 Synchronization achieved.	0x0	R
		2	CKS5		Computed checksum status for Lane 5 (ignore this output when NO_ILAS = 1). 0 Checksum is incorrect. 1 Checksum is correct.	0x0	R
		1	FS5		Frame sync status for Lane 5 (ignore this output when NO_ILAS = 1). 0 Synchronization lost. 1 Synchronization achieved.	0x0	R
		0	CGS5		Code group sync status for Lane 5. 0 Synchronization lost. 1 Synchronization achieved.	0x0	R
0x4B6	LINK_STATUS6	7	BDE6		Bad disparity errors status for Lane 6. 0 Error count < ETH[7:0] value. 1 Error count ≥ ETH[7:0] value.	0x0	R
		6	NIT6		Not in table errors status for Lane 6. 0 Error count < ETH[7:0] value. 1 Error count ≥ ETH[7:0] value.	0x0	R
		5	UEK6		Unexpected K character errors status for Lane 6. 0 Error count < ETH[7:0] value. 1 Error count ≥ ETH[7:0] value.	0x0	R
		4	ILD6		Interlane deskew status for Lane 6 (ignore this output when NO_ILAS = 1). 0 Deskew failed. 1 Deskew achieved.	0x0	R
		3	ILS6		Initial lane synchronization status for Lane 6 (ignore this output when NO_ILAS = 1). 0 Synchronization lost. 1 Synchronization achieved.	0x0	R
		2	CKS6		Computed checksum status for Lane 6 (ignore this output when NO_ILAS = 1). 0 Checksum is incorrect. 1 Checksum is correct.	0x0	R
		1	FS6		Frame sync status for Lane 6 (ignore this output when NO_ILAS = 1). 0 Synchronization lost. 1 Synchronization achieved.	0x0	R
		0	CGS6		Code group sync status for Lane 6. 0 Synchronization lost. 1 Synchronization achieved.	0x0	R

Hex. Addr.	Name	Bits	Bit Name	Settings	Description	Reset	Access
0x4B7	LINK_STATUS7	7	BDE7		Bad disparity errors status for Lane 7. 0 Error count < ETH[7:0] value. 1 Error count ≥ ETH[7:0] value.	0x0	R
		6	NIT7		Not in table errors status for Lane 7. 0 Error count < ETH[7:0] value. 1 Error count ≥ ETH[7:0] value.	0x0	R
		5	UEK7		Unexpected K character errors status for Lane 7. 0 Error count < ETH[7:0] value. 1 Error count ≥ ETH[7:0] value.	0x0	R
		4	ILD7		Interlane deskew status for Lane 7 (ignore this output when NO_ILAS = 1). 0 Deskew failed. 1 Deskew achieved.	0x0	R
		3	ILS7		Initial lane synchronization status for Lane 7 (ignore this output when NO_ILAS = 1). 0 Synchronization lost. 1 Synchronization achieved.	0x0	R
		2	CKS7		Computed checksum status for Lane 7 (ignore this output when NO_ILAS = 1). 0 Checksum is incorrect. 1 Checksum is correct.	0x0	R
		1	FS7		Frame sync status for Lane 7 (ignore this output when NO_ILAS = 1). 0 Synchronization lost. 1 Synchronization achieved.	0x0	R
		0	CGS7		Code group sync status for Lane 7. 0 Synchronization lost. 1 Synchronization achieved.	0x0	R
0x4B8	JESD_IRQ_ENABLEA	7	EN_BDE		Bad disparity error counter.	0x0	R/W
		6	EN_NIT		Not in table error counter.	0x0	R/W
		5	EN_UEK		Unexpected K error counter.	0x0	R/W
		4	EN_ILD		Interlane deskew.	0x0	R/W
		3	EN_ILS		Initial lane sync.	0x0	R/W
		2	EN_CKS		Good checksum. This is an interrupt that compares two checksums: the checksum that the transmitter sent over the link during the ILAS, and the checksum that the receiver calculated from the ILAS data that the transmitter sent over the link. Note that the checksum IRQ never at any time looks at the checksum that is programmed over the SPI into Register 0x45D. The checksum IRQ only looks at the data sent by the transmitter, and never looks at any data programmed via the SPI.	0x0	R/W
		1	EN_FS		Frame sync.	0x0	R/W
		0	EN_CGS		Code group sync.	0x0	R/W

Hex. Addr.	Name	Bits	Bit Name	Settings	Description	Reset	Access
0x4B9	JESD_IRQ_ENABLEB	[7:1]	RESERVED		Reserved.	0x0	R
		0	EN_ILAS		Configuration mismatch (checked for Lane 0 only). The ILAS IRQ compares the two sets of ILAS data that the receiver has: the ILAS data sent over the JESD204B link by the transmitter, and the ILAS data programmed into the receiver via the SPI (Register 0x450 to Register 0x45D). If the data differs, the IRQ is triggered. Note that all of the ILAS data (including the checksum) is compared.	0x0	R/W
0x4BA	JESD_IRQ_STATUSA	7	IRQ_BDE		Bad disparity error counter.	0x0	R/W
		6	IRQ_NIT		Not in table error counter.	0x0	R/W
		5	IRQ_UEK		Unexpected K error counter.	0x0	R/W
		4	IRQ_ILD		Interlane deskew.	0x0	R/W
		3	IRQ_ILS		Initial lane sync.	0x0	R/W
		2	IRQ_CKS		Good checksum.	0x0	R/W
		1	IRQ_FS		Frame sync.	0x0	R/W
		0	IRQ_CGS		Code group sync.	0x0	R/W
0x4BB	JESD_IRQ_STATUSB	[7:1]	RESERVED		Reserved.	0x0	R
		0	IRQ_ILAS		Configuration mismatch (checked for Lane 0 only).	0x0	R/W
0x800	HOPF_CTRL	[7:6]	HOPF_MODE		Frequency switch mode.	0x0	R/W
				00	Phase continuous switch. Changes frequency tuning word, and the phase accumulator continues to accumulate to the new FTW.		
				01	Phase discontinuous switch. Changes the frequency tuning word and resets the phase accumulator.		
		10	Reserved.				
		[5:0]	RESERVED		Reserved.	0x0	R

