

FEATURES

- Four On-Chip Track/Hold Amplifiers
- Simultaneous Sampling of 4 Channels
- Fast 12-Bit ADC with 8 μ s Conversion Time/Channel
- 29 kHz Sample Rate for All Four Channels
- On-Chip Reference
- ± 10 V Input Range
- ± 5 V Supplies

APPLICATIONS

- Sonar
- Motor Controllers
- Adaptive Filters
- Digital Signal Processing

GENERAL DESCRIPTION

The AD7874 is a four-channel simultaneous sampling, 12-bit data acquisition system. The part contains a high speed 12-bit ADC, on-chip reference, on-chip clock and four track/hold amplifiers. This latter feature allows the four input channels to be sampled simultaneously, thus preserving the relative phase information of the four input channels, which is not possible if all four channels share a single track/hold amplifier. This makes the AD7874 ideal for applications such as phased-array sonar and ac motor controllers where the relative phase information is important.

The aperture delay of the four track/hold amplifiers is small and specified with minimum and maximum limits. This allows several AD7874s to sample multiple input channels simultaneously without incurring phase errors between signals connected to several devices. A reference output/reference input facility also allows several AD7874s to be driven from the same reference source.

In addition to the traditional dc accuracy specifications such as linearity, full-scale and offset errors, the AD7874 is also fully specified for dynamic performance parameters including distortion and signal-to-noise ratio.

The AD7874 is fabricated in Analog Devices' Linear Compatible CMOS (LC²MOS) process, a mixed technology process that combines precision bipolar circuits with low-power CMOS logic. The part is available in a 28-pin, 0.6" wide, plastic or hermetic dual-in-line package (DIP), in a 28-terminal leadless ceramic chip carrier (LCCC) and in a 28-pin SOIC.

REV. C

Information furnished by Analog Devices is believed to be accurate and reliable. However, no responsibility is assumed by Analog Devices for its use, nor for any infringements of patents or other rights of third parties which may result from its use. No license is granted by implication or otherwise under any patent or patent rights of Analog Devices.

FUNCTIONAL BLOCK DIAGRAM

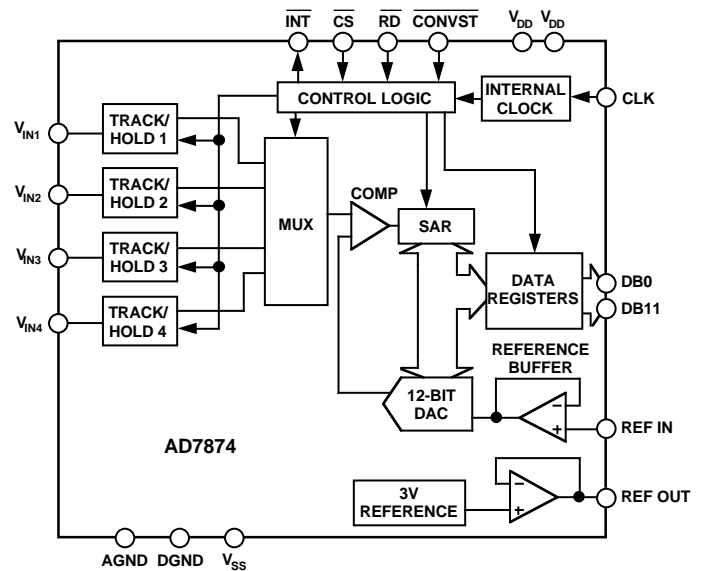

PRODUCT HIGHLIGHTS

1. **Simultaneous Sampling of Four Input Channels.**
Four input channels, each with its own track/hold amplifier, allow simultaneous sampling of input signals. Track/hold acquisition time is 2 μ s, and the conversion time per channel is 8 μ s, allowing 29 kHz sample rate for all four channels.
2. **Tight Aperture Delay Matching.**
The aperture delay for each channel is small and the aperture delay matching between the four channels is less than 4 ns. Additionally, the aperture delay specification has upper and lower limits allowing multiple AD7874s to sample more than four channels.
3. **Fast Microprocessor Interface.**
The high speed digital interface of the AD7874 allows direct connection to all modern 16-bit microprocessors and digital signal processors.

AD7874–SPECIFICATIONS

($V_{DD} = +5\text{ V}$, $V_{SS} = -5\text{ V}$, $AGND = DGND = 0\text{ V}$, $REF\ IN = +3\text{ V}$, $f_{CLK} = 2.5\text{ MHz}$ external. All specifications T_{MIN} to T_{MAX} unless otherwise noted.)

Parameter	A Version	B Version	S Version	Units	Test Conditions/Comments
SAMPLE-AND-HOLD					
Acquisition Time ² to 0.01%	2	2	2	μs max	$V_{IN} = 500\text{ mV p-p}$
Droop Rate ^{2, 3}	1	1	2	mV/ms max	
-3 dB Small Signal Bandwidth ³	500	500	500	kHz typ	
Aperture Delay ²	0	0	0	ns min	
Aperture Jitter ^{2, 3}	40	40	40	ns max	
Aperture Delay Matching ²	200	200	200	ps typ	
	4	4	4	ns max	
SAMPLE-AND-HOLD AND ADC DYNAMIC PERFORMANCE					
Signal-to-Noise Ratio	70	71	70	dB min	$f_{IN} = 10\text{ kHz Sine Wave}$, $f_{SAMPLE} = 29\text{ kHz}$
Total Harmonic Distortion	-78	-80	-78	dB max	$f_{IN} = 10\text{ kHz Sine Wave}$, $f_{SAMPLE} = 29\text{ kHz}$
Peak Harmonic or Spurious Noise	-78	-80	-78	dB max	$f_{IN} = 10\text{ kHz Sine Wave}$, $f_{SAMPLE} = 29\text{ kHz}$
Intermodulation Distortion					$f_a = 9\text{ kHz}$, $f_b = 9.5\text{ kHz}$, $f_{SAMPLE} = 29\text{ kHz}$
2nd Order Terms	-80	-80	-80	dB max	
3rd Order Terms	-80	-80	-80	dB max	
Channel-to-Channel Isolation ²	-80	-80	-80	dB max	
DC ACCURACY					
Resolution	12	12	12	Bits	
Relative Accuracy	±1	±1/2	±1	LSB max	No Missing Codes Guaranteed Any Channel Any Channel Between Channels Any Channel Between Channels
Differential Nonlinearity	±1	±1	±1	LSB max	
Positive Full-Scale Error ⁴	±5	±5	±5	LSB max	
Negative Full-Scale Error ⁴	±5	±5	±5	LSB max	
Full-Scale Error Match	5	5	5	LSB max	
Bipolar Zero Error	±5	±5	±5	LSB max	
Bipolar Zero Error Match	4	4	4	LSB max	
ANALOG INPUTS					
Input Voltage Range	±10	±10	±10	Volts	
Input Current	±600	±600	±600	μA max	
REFERENCE OUTPUTS					
REF OUT	3	3	3	V nom	Reference Load Current Change (0–500 μA) Reference Load Should Not Be Changed During Conversion
REF OUT Error @ +25°C	±0.33	±0.33	±0.33	% max	
T_{MIN} to T_{MAX}	±1	±1	±1	% max	
REF OUT Temperature Coefficient	±35	±35	±35	ppm/°C typ	
Reference Load Change	±1	±1	±2	mV max	
REFERENCE INPUT					
Input Voltage Range	2.85/3.15	2.85/3.15	2.85/3.15	V min/V max	3 V ± 5%
Input Current	±1	±1	±1	μA max	
Input Capacitance ³	10	10	10	pF max	
LOGIC INPUTS					
Input High Voltage, V_{INH}	2.4	2.4	2.4	V min	$V_{DD} = 5\text{ V} \pm 5\%$
Input Low Voltage, V_{INL}	0.8	0.8	0.8	V max	$V_{DD} = 5\text{ V} \pm 5\%$
Input Current, I_{IN}	±10	±10	±10	μA max	$V_{IN} = 0\text{ V to }V_{DD}$
Input Capacitance, C_{IN} ³	10	10	10	pF max	
LOGIC OUTPUTS					
Output High Voltage, V_{OH}	4.0	4.0	4.0	V min	$V_{DD} = 5\text{ V} \pm 5\%$; $I_{SOURCE} = 40\text{ μA}$
Output Low Voltage, V_{OL}	0.4	0.4	0.4	V max	$V_{DD} = 5\text{ V} \pm 5\%$; $I_{SINK} = 1\text{--}6\text{ mA}$
DB0–DB11					
Floating-State Leakage Current	±10	±10	±10	μA max	$V_{IN} = 0\text{ V to }V_{DD}$
Floating-State Output Capacitance	10	10	10	pF max	
Output Coding	2s COMPLEMENT				
POWER REQUIREMENTS					
V_{DD}	+5	+5	+5	V nom	±5% for Specified Performance
V_{SS}	-5	-5	-5	V nom	±5% for Specified Performance
I_{DD}	18	18	18	mA max	$\overline{CS} = \overline{RD} = \overline{CONVST} = +5\text{ V}$; Typically 12 mA
I_{SS}	12	12	12	mA max	$\overline{CS} = \overline{RD} = \overline{CONVST} = +5\text{ V}$; Typically 8 mA
Power Dissipation	150	150	150	mW max	$\overline{CS} = \overline{RD} = \overline{CONVST} = +5\text{ V}$; Typically 100 mW

NOTES

¹Temperature ranges are as follows: A, B Versions: -40°C to +85°C; S Version: -55°C to +125°C.

²See Terminology.

³Sample tested @ +25°C to ensure compliance.

⁴Measured with respect to the REF IN voltage and includes bipolar offset error.

⁵For capacitive loads greater than 50 pF a series resistor is required.

Specifications subject to change without notice.

TIMING CHARACTERISTICS¹ ($V_{DD} = +5\text{ V} \pm 5\%$, $V_{SS} = -5\text{ V} \pm 5\%$, $AGND = DGND = 0\text{ V}$, $t_{CLK} = 2.5\text{ MHz}$ external unless otherwise noted.)

Parameter	A, B Versions	S Version	Units	Conditions/Comments
t_1	50	50	ns min	\overline{CONVST} Pulse Width
t_2	0	0	ns min	\overline{CS} to \overline{RD} Setup Time
t_3	60	70	ns min	\overline{RD} Pulse Width
t_4	0	0	ns min	\overline{CS} to \overline{RD} Hold Time
t_5	60	60	ns max	\overline{RD} to \overline{INT} Delay
t_6^2	57	70	ns max	Data Access Time after \overline{RD}
t_7^3	5	5	ns min	Bus Relinquish Time after \overline{RD}
	45	50	ns max	
t_8	130	150	ns min	Delay Time between Reads
t_{CONV}	31	31	μs min	\overline{CONVST} to \overline{INT} , External Clock
	32.5	32.5	μs max	\overline{CONVST} to \overline{INT} , External Clock
	31	31	μs min	\overline{CONVST} to \overline{INT} , Internal Clock
	35	35	μs max	\overline{CONVST} to \overline{INT} , Internal Clock
t_{CLK}	10	10	μs max	Minimum Input Clock Period

NOTES

¹Timing Specifications in **bold print** are 100% production tested. All other times are sample tested at +25°C to ensure compliance. All input signals are specified with $t_r = t_f = 5\text{ ns}$ (10% to 90% of +5 V) and timed from a voltage level of 1.6 V.

² t_6 is measured with the load circuit of Figure 1 and defined as the time required for an output to cross 0.8 V or 2.4 V.

³ t_7 is derived from the measured time taken by the data outputs to change 0.5 V when loaded with the circuit of Figure 2. The measured number is then extrapolated back to remove the effects of charging or discharging the 50 pF capacitor. This means that the time, t_7 , quoted in the timing characteristics is the true bus relinquish time of the part and as such is independent of external bus loading capacitances.

Specifications subject to change without notice.

ABSOLUTE MAXIMUM RATINGS*

($T_A = +25^\circ\text{C}$ unless otherwise noted)

V_{DD} to AGND -0.3 V to +7 V

V_{DD} to DGND -0.3 V to +7 V

V_{SS} to AGND +0.3 V to -7 V

AGND to DGND -0.3 V to $V_{DD} + 0.3\text{ V}$

V_{IN} to AGND -15 V to +15 V

REF OUT to AGND 0 V to V_{DD}

Digital Inputs to DGND -0.3 V to $V_{DD} + 0.3\text{ V}$

Digital Outputs to DGND -0.3 V to $V_{DD} + 0.3\text{ V}$

Operating Temperature Range

Commercial (A, B Versions) -40°C to +85°C

Extended (S Version) -55°C to +125°C

Storage Temperature Range -65°C to +150°C

Lead Temperature (Soldering, 10 secs) +300°C

Power Dissipation (Any Package) to +75°C 1,000 mW

Derates above +75°C by 10 mW/°C

*Stresses above those listed under "Absolute Maximum Ratings" may cause permanent damage to the device. This is a stress rating only and functional operation of the device at these or any other conditions above those listed in the operational sections of this specifications is not implied. Exposure to absolute maximum rating conditions for extended periods may affect device reliability.

CAUTION

ESD (electrostatic discharge) sensitive device. Electrostatic charges as high as 4000 V readily accumulate on the human body and test equipment and can discharge without detection. Although the AD7874 features proprietary ESD protection circuitry, permanent damage may occur on devices subjected to high energy electrostatic discharges. Therefore, proper ESD precautions are recommended to avoid performance degradation or loss of functionality.

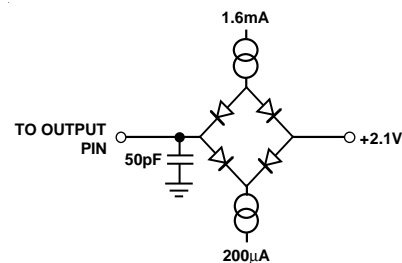

Figure 1. Load Circuit for Access Time

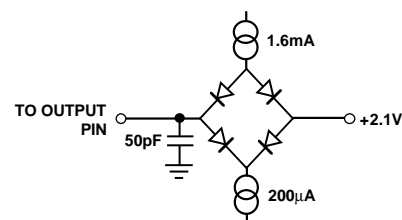

Figure 2. Load Circuit for Bus Relinquish Time



AD7874

TERMINOLOGY

ACQUISITION TIME

Acquisition Time is the time required for the output of the track/hold amplifiers to reach their final values, within $\pm 1/2$ LSB, after the falling edge of $\overline{\text{INT}}$ (the point at which the track/hold returns to track mode). This includes switch delay time, slewing time and settling time for a full-scale voltage change.

APERTURE DELAY

Aperture Delay is defined as the time required by the internal switches to disconnect the hold capacitors from the inputs. This produces an effective delay in sample timing. It is measured by applying a step input and adjusting the CONVST input position until the output code follows the step input change.

APERTURE DELAY MATCHING

Aperture Delay Matching is the maximum deviation in aperture delays across the four on-chip track/hold amplifiers.

APERTURE JITTER

Aperture Jitter is the uncertainty in aperture delay caused by internal noise and variation of switching thresholds with signal level.

DROOP RATE

Droop Rate is the change in the held analog voltage resulting from leakage currents.

CHANNEL-TO-CHANNEL ISOLATION

Channel-to-Channel Isolation is a measure of the level of crosstalk between channels. It is measured by applying a full-scale 1 kHz signal to the other three inputs. The figure given is the worst case across all four channels.

SNR, THD, IMD

See DYNAMIC SPECIFICATIONS section.

PIN CONFIGURATIONS

DIP and SOIC

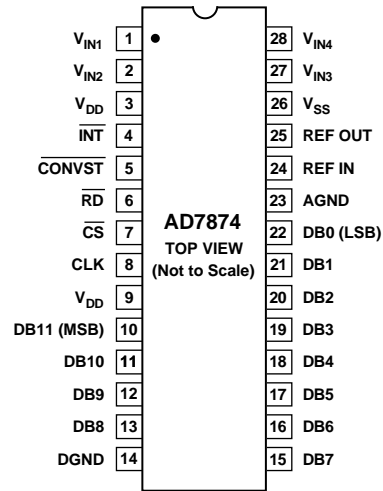

LCCC

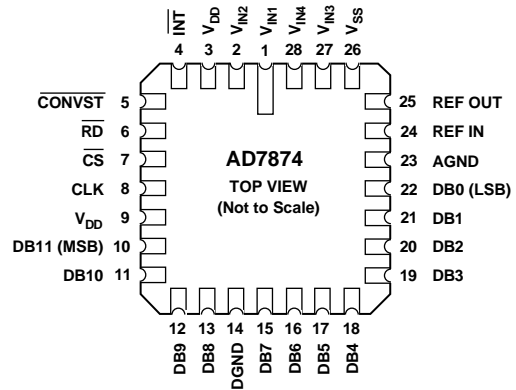

PIN FUNCTION DESCRIPTION

Pin	Mnemonic	Description
1	V _{IN1}	Analog Input Channel 1. This is the first of the four input channels to be converted in a conversion cycle. Analog input voltage range is ± 10 V.
2	V _{IN2}	Analog Input Channel 2. Analog input voltage range is ± 10 V.
3	V _{DD}	Positive supply voltage, $+5$ V \pm 5%. This pin should be decoupled to AGND.
4	$\overline{\text{INT}}$	Interrupt. Active low logic output indicating converter status. See Figure 7.
5	$\overline{\text{CONVST}}$	Convert Start. Logic Input. A low to high transition on this input puts the track/hold into its hold mode and starts conversion. The four channels are converted sequentially, Channel 1 to Channel 4. The CONVST input is asynchronous to CLK and independent of CS and $\overline{\text{RD}}$.
6	$\overline{\text{RD}}$	Read. Active low logic input. This input is used in conjunction with $\overline{\text{CS}}$ low to enable the data outputs. Four successive reads after a conversion will read the data from the four channels in the sequence, Channel 1, 2, 3, 4.
7	$\overline{\text{CS}}$	Chip Select. Active low logic input. The device is selected when this input is active.
8	CLK	Clock Input. An external TTL-compatible clock may be applied to this input pin. Alternatively, tying this pin to V _{SS} enables the internal laser trimmed clock oscillator.
9	V _{DD}	Positive Supply Voltage, $+5$ V \pm 5%. Same as Pin 3; both pins must be tied together at the package. This pin should be decoupled to DGND.
10	DB11	Data Bit 11 (MSB). Three-state TTL output. Output coding is 2s complement.
11–13	DB10–DB8	Data Bit 10 to Data Bit 8. Three-state TTL outputs.
14	DGND	Digital Ground. Ground reference for digital circuitry.
15–21	DB7–DB1	Data Bit 7 to Data Bit 1. Three-state TTL outputs.
22	DB0	Data Bit 0 (LSB). Three-state TTL output.
23	AGND	Analog Ground. Ground reference for track/hold, reference and DAC.
24	REF IN	Voltage Reference Input. The reference voltage for the part is applied to this pin. It is internally buffered, requiring an input current of only ± 1 μ A. The nominal reference voltage for correct operation of the AD7874 is 3 V.
25	REF OUT	Voltage Reference Output. The internal 3 V analog reference is provided at this pin. To operate the AD7874 with internal reference, REF OUT is connected to REF IN. The external load capability of the reference is 500 μ A.
26	V _{SS}	Negative Supply Voltage, -5 V \pm 5%.
27	V _{IN3}	Analog Input Channel 3. Analog input voltage range is ± 10 V.
28	V _{IN4}	Analog Input Channel 4. Analog input voltage range is ± 10 V.

ORDERING GUIDE

Model ¹	Relative Temperature Range	SNR (dBs)	Accuracy (LSB)	Package Option ²
AD7874AN	-40°C to +85°C	70 min	± 1 max	N-28
AD7874BN	-40°C to +85°C	72 min	$\pm 1/2$ max	N-28
AD7874AR	-40°C to +85°C	70 min	± 1 max	R-28
AD7874BR	-40°C to +85°C	72 min	$\pm 1/2$ max	R-28
AD7874AQ	-40°C to +85°C	70 min	± 1 max	Q-28
AD7874BQ	-40°C to +85°C	72 min	$\pm 1/2$ max	Q-28
AD7874SQ ³	-55°C to +125°C	70 min	± 1 max	Q-28
AD7874SE ³	-55°C to +125°C	70 min	± 1 max	E-28A

NOTES

¹To order MIL-STD-883, Class B processed parts, add /883B to part number. Contact our local sales office for military data sheet and availability.

²E = Leaded Ceramic Chip Carrier; N = Plastic DIP; Q = Cerdip; R = SOIC.

³Available to /883B processing only.

AD7874

CONVERTER DETAILS

The AD7874 is a complete 12-bit, 4-channel data acquisition system. It is comprised of a 12-bit successive approximation ADC, four high speed track/hold circuits, a four-channel analog multiplexer and a 3 V Zener reference. The ADC uses a successive approximation technique and is based on a fast-settling, voltage switching DAC, a high speed comparator, a fast CMOS SAR and high speed logic.

Conversion is initiated on the rising edge of $\overline{\text{CONVST}}$. All four input track/holds go from track to hold on this edge. Conversion is first performed on the Channel 1 input voltage, then Channel 2 is converted and so on. The four results are stored in on-chip registers. When all four conversions have been completed, $\overline{\text{INT}}$ goes low indicating that data can be read from these locations. The conversion sequence takes either 78 or 79 rising clock edges depending on the synchronization of $\overline{\text{CONVST}}$ with CLK. Internal delays and reset times bring the total conversion time from $\overline{\text{CONVST}}$ going high to $\overline{\text{INT}}$ going low to 32.5 μs maximum for a 2.5 MHz external clock. The AD7874 uses an implicit addressing scheme whereby four successive reads to the same memory location access the four data words sequentially. The first read accesses Channel 1 data, the second read accesses Channel 2 data and so on. Individual data registers cannot be accessed independently.

INTERNAL REFERENCE

The AD7874 has an on-chip temperature compensated buried Zener reference which is factory trimmed to $3\text{ V} \pm 10\text{ mV}$ (see Figure 3). The reference voltage is provided at the REF OUT pin. This reference can be used to provide both the reference voltage for the ADC and the bipolar bias circuitry. This is achieved by connecting REF OUT to REF IN.

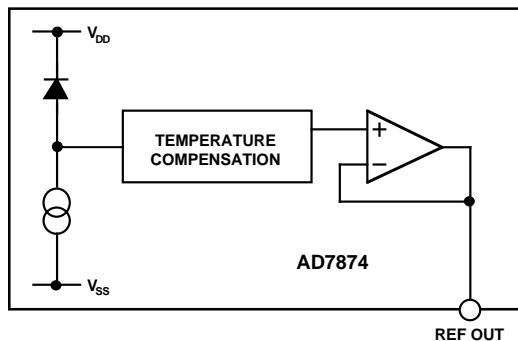

Figure 3. AD7874 Internal Reference

The reference can also be used as a reference for other components and is capable of providing up to 500 μA to an external load. In systems using several AD7874s, using the REF OUT of one device to provide the REF IN for the other devices ensures good full-scale tracking between all the AD7874s. Because the AD7874 REF IN is buffered, each AD7874 presents a high impedance to the reference so one AD7874 REF OUT can drive several AD7874 REF INs.

The maximum recommended capacitance on REF OUT for normal operation is 50 pF. If the reference is required for other system uses, it should be decoupled to AGND with a 200 Ω resistor in series with a parallel combination of a 10 μF tantalum capacitor and a 0.1 μF ceramic capacitor.

EXTERNAL REFERENCE

In some applications, the user may require a system reference or some other external reference to drive the AD7874 reference input. Figure 4 shows how the AD586 5 V reference can be used to provide the 3 V reference required by the AD7874 REF IN.

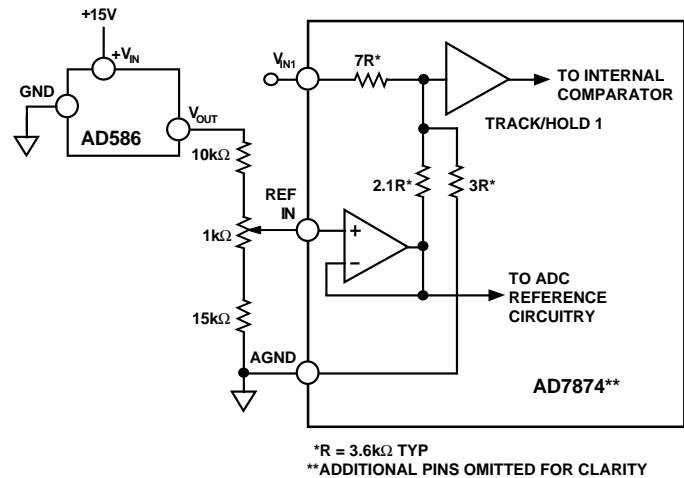

Figure 4. AD586 Driving AD7874 REF IN

TRACK-AND-HOLD AMPLIFIER

The track-and-hold amplifier on each analog input of the AD7874 allows the ADC to accurately convert an input sine wave of 20 V p-p amplitude to 12-bit accuracy. The input bandwidth of the track/hold amplifier is greater than the Nyquist rate of the ADC even when the ADC is operated at its maximum throughput rate. The small signal 3 dB cutoff frequency occurs typically at 500 kHz.

The four track/hold amplifiers sample their respective input channels simultaneously. The aperture delay of the track/hold circuits is small and, more importantly, is well matched across the four track/holds on one device and also well matched from device to device. This allows the relative phase information between different input channels to be accurately preserved. It also allows multiple AD7874s to sample more than four channels simultaneously.

The operation of the track/hold amplifiers is essentially transparent to the user. Once conversion is initiated, the four channels are automatically converted and there is no need to select which channel is to be digitized.

ANALOG INPUT

The analog input of Channel 1 of the AD7874 is as shown in Figure 4. The analog input range is $\pm 10\text{ V}$ into an input resistance of typically 30 k Ω . The designed code transitions occur midway between successive integer LSB values (i.e., 1/2 LSB, 3/2 LSBs, 5/2 LSBs, . . . FS - 3/2 LSBs). The output code is 2s complement binary with 1 LSB = $\text{FS}/4096 = 20\text{ V}/4096 = 4.88\text{ mV}$. The ideal input/output transfer function is shown in Figure 5.

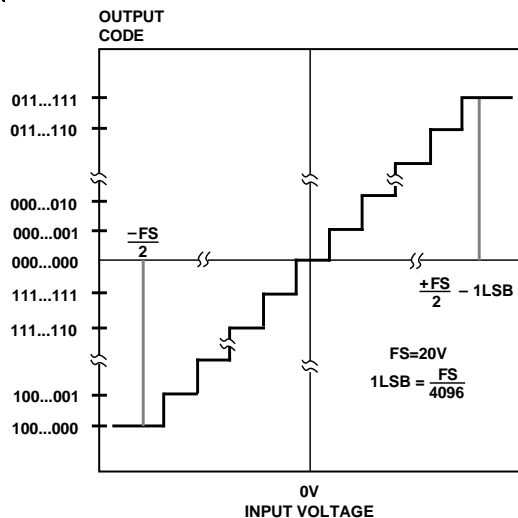

Figure 5. Input/Output Transfer Function

OFFSET AND FULL-SCALE ADJUSTMENT

In most Digital Signal Processing (DSP) applications, offset and full-scale errors have little or no effect on system performance. Offset error can always be eliminated in the analog domain by ac coupling. Full-scale error effect is linear and does not cause problems as long as the input signal is within the full dynamic range of the ADC. Invariably, some applications will require that the input signal span the full analog input dynamic range. In such applications, offset and full-scale error will have to be adjusted to zero.

Figure 6 shows a circuit which can be used to adjust the offset and full-scale errors on the AD7874 (Channel 1 is shown for example purposes only). Where adjustment is required, offset error must be adjusted before full-scale error. This is achieved by trimming the offset of the op amp driving the analog input of the AD7874 while the input voltage is a 1/2 LSB below analog ground. The trim procedure is as follows: apply a voltage of -2.44 mV ($-1/2\text{ LSB}$) at V_1 in Figure 6 and adjust the op amp offset voltage until the ADC output code flickers between 1111 1111 1111 and 0000 0000 0000.

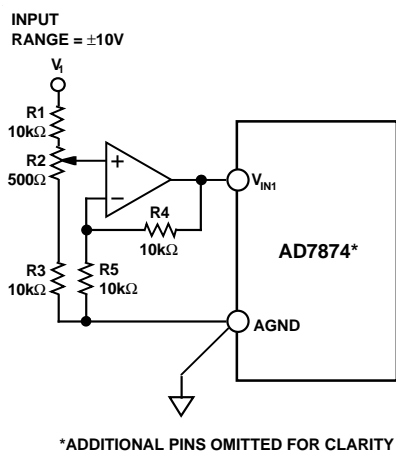

Figure 6. AD7874 Full-Scale Adjust Circuit

Gain error can be adjusted at either the first code transition (ADC negative full scale) or the last code transition (ADC positive full scale). The trim procedures for both cases are as follows:

Positive Full-Scale Adjust

Apply a voltage of $+9.9927\text{ V}$ ($FS/2 - 3/2\text{ LSBs}$) at V_1 . Adjust R_2 until the ADC output code flickers between 0111 1111 1110 and 0111 1111 1111.

Negative Full-Scale Adjust

Apply a voltage of -9.9976 V ($-FS + 1/2\text{ LSB}$) at V_1 and adjust R_2 until the ADC output code flickers between 1000 0000 0000 and 1000 0000 0001.

An alternative scheme for adjusting full-scale error in systems which use an external reference is to adjust the voltage at the REF IN pin until the full-scale error for any of the channels is adjusted out. The good full-scale matching of the channels will ensure small full-scale errors on the other channels.

TIMING AND CONTROL

Conversion is initiated on the AD7874 by asserting the $\overline{\text{CONVST}}$ input. This $\overline{\text{CONVST}}$ input is an asynchronous input which is independent of the ADC clock. This is essential for applications where precise sampling in time is important. In these applications, the signal sampling must occur at exactly equal intervals to minimize errors due to sampling uncertainty or jitter. In these cases, the $\overline{\text{CONVST}}$ input is driven from a timer or precise clock source. Once conversion is started, $\overline{\text{CONVST}}$ should not be asserted again until conversion is complete on all four channels.

In applications where precise time interval sampling is not critical, the $\overline{\text{CONVST}}$ pulse can be generated from a microprocessor WRITE or READ line gated with a decoded address (different to the AD7874 $\overline{\text{CS}}$ address). $\overline{\text{CONVST}}$ should not be derived from a decoded address alone because very short $\overline{\text{CONVST}}$ pulses (which may occur in some microprocessor systems as the address bus is changing at the start of an instruction cycle) could initiate a conversion.

All four track/hold amplifiers go from track to hold on the rising edge of the $\overline{\text{CONVST}}$ pulse. The four track/hold amplifiers remain in their hold mode while all four channels are converted. The rising edge of $\overline{\text{CONVST}}$ also initiates a conversion on the Channel 1 input voltage (V_{IN1}). When conversion is complete on Channel 1, its result is stored in Data Register 1, one of four on-chip registers used to store the conversion results. When the result from the first conversion is stored, conversion is initiated on the voltage held by track/hold 2. When conversion has been completed on the voltage held by track/hold 4 and its result is stored in Data Register 4, $\overline{\text{INT}}$ goes low to indicate that the conversion process is complete.

The sequence in which the channel conversions takes place is automatically taken care of by the AD7874. This means that the user does not have to provide address lines to the AD7874 or worry about selecting which channel is to be digitized.

Reading data from the device consists of four read operations to the same microprocessor address. Addressing of the four on-chip data registers is again automatically taken care of by the AD7874.

AD7874

The first read operation to the AD7874 after conversion always accesses data from Data Register 1 (i.e., the conversion result from the V_{IN1} input). \overline{INT} is reset high on the falling edge of \overline{RD} during this first read operation. The second read always accesses data from Data Register 2 and so on. The address pointer is reset to point to Data Register 1 on the rising edge of \overline{CONVST} . A read operation to the AD7874 should not be attempted during conversion. The timing diagram for the AD7874 conversion sequence is shown in Figure 7.

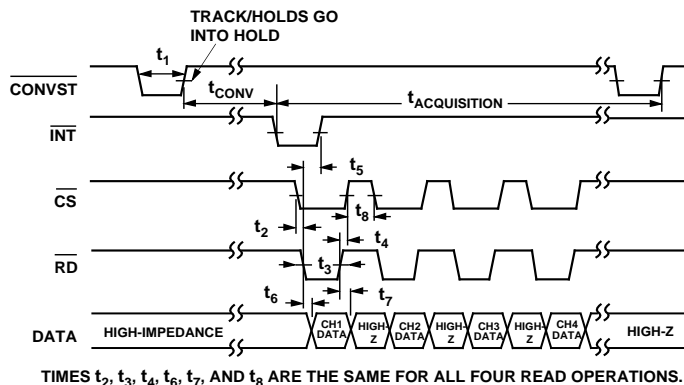

Figure 7. AD7874 Timing Diagram

AD7874 DYNAMIC SPECIFICATIONS

The AD7874 is specified and 100% tested for dynamic performance specifications as well as traditional dc specifications such as Integral and Differential Nonlinearity. These ac specifications are required for the signal processing applications such as phased array sonar, adaptive filters and spectrum analysis. These applications require information on the ADC's effect on the spectral content of the input signal. Hence, the parameters for which the AD7874 is specified include SNR, harmonic distortion, intermodulation distortion and peak harmonics. These terms are discussed in more detail in the following sections.

Signal-to-Noise Ratio (SNR)

SNR is the measured signal to noise ratio at the output of the ADC. The signal is the rms magnitude of the fundamental. Noise is the rms sum of all the nonfundamental signals up to half the sampling frequency ($f_s/2$) excluding dc. SNR is dependent upon the number of quantization levels used in the digitization process; the more levels, the smaller the quantization noise. The theoretical signal to noise ratio for a sine wave input is given by

$$SNR = (6.02N + 1.76) \text{ dB} \quad (1)$$

where N is the number of bits.

Thus for an ideal 12-bit converter, $SNR = 74 \text{ dB}$.

The output spectrum from the ADC is evaluated by applying a sine wave signal of very low distortion to the V_{IN} input which is sampled at a 29 kHz sampling rate. A Fast Fourier Transform (FFT) plot is generated from which the SNR data can be obtained. Figure 8 shows a typical 2048 point FFT plot of the AD7874BN with an input signal of 10 kHz and a sampling frequency of 29 kHz. The SNR obtained from this graph is 73.2 dB. It should be noted that the harmonics are taken into account when calculating the SNR.

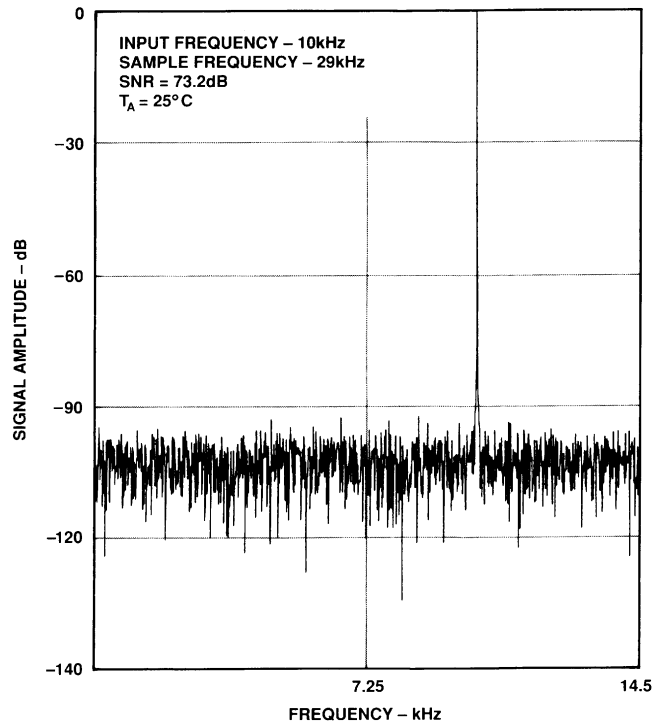

Figure 8. AD7874 FFT Plot

Effective Number of Bits

The formula given in Equation 1 relates the SNR to the number of bits. Rewriting the formula, as in Equation 2, it is possible to get a measure of performance expressed in effective number of bits (N).

$$N = \frac{SNR - 1.76}{6.02} \quad (2)$$

The effective number of bits for a device can be calculated directly from its measured SNR.

Figure 9 shows a typical plot of effective number of bits versus frequency for an AD7874BN with a sampling frequency of 29 kHz. The effective number of bits typically falls between 11.75 and 11.87 corresponding to SNR figures of 72.5 dB and 73.2 dB.

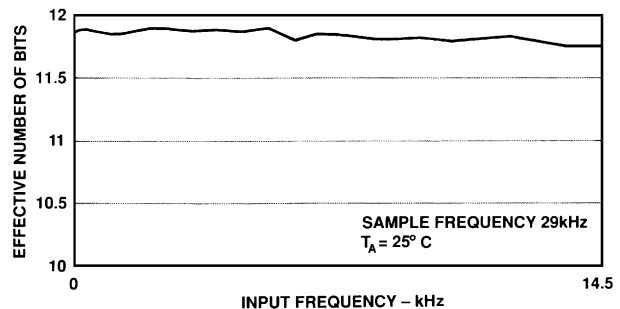

Figure 9. Effective Numbers of Bits vs. Frequency

Total Harmonic Distortion (THD)

Total Harmonic Distortion (THD) is the ratio of the rms sum of harmonics to the rms value of the fundamental. For the AD7874, THD is defined as

$$THD = 20 \log \frac{\sqrt{V_2^2 + V_3^2 + V_4^2 + V_5^2 + V_6^2}}{V_1}$$

where V_1 is the rms amplitude of the fundamental and V_2 , V_3 , V_4 , V_5 and V_6 are the rms amplitudes of the second through the sixth harmonic. The THD is also derived from the FFT plot of the ADC output spectrum.

Intermodulation Distortion

With inputs consisting of sine waves at two frequencies, f_a and f_b , any active device with nonlinearities will create distortion products at sum and difference frequencies of $m f_a \pm n f_b$ where $m, n = 0, 1, 2, 3, \dots$, etc. Intermodulation terms are those for which neither m or n are equal to zero. For example, the second order terms include $(f_a + f_b)$ and $(f_a - f_b)$ while the third order terms include $(2f_a + f_b)$, $(2f_a - f_b)$, $(f_a + 2f_b)$ and $(f_a - 2f_b)$.

Using the CCIF standard where two input frequencies near the top end of the input bandwidth are used, the second and third order terms are of different significance. The second order terms are usually distanced in frequency from the original sine waves while the third order terms are usually at a frequency close to the input frequencies. As a result, the second and third order terms are specified separately. The calculation of the intermodulation distortion is as per the THD specification where it is the ratio of the rms sum of the individual distortion products to the rms amplitude of the fundamental expressed in dBs. In this case, the input consists of two, equal amplitude, low distortion sine waves. Figure 10 shows a typical IMD plot for the AD7874.

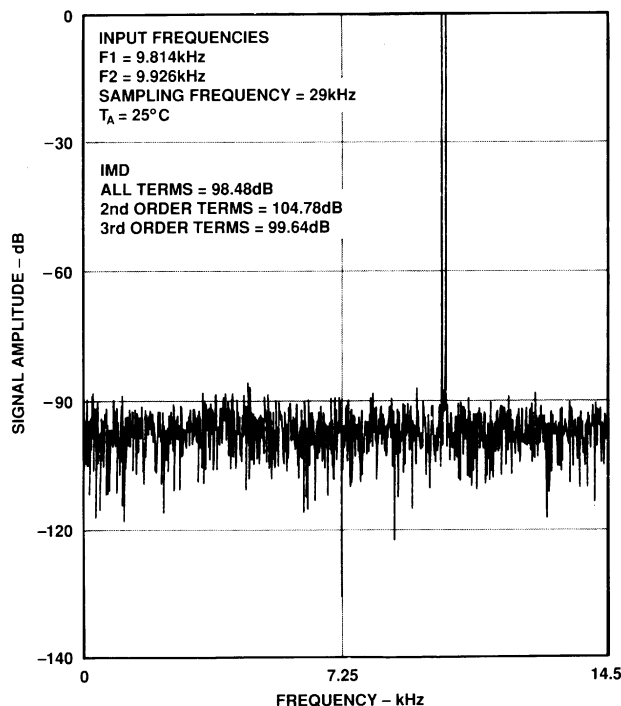

Figure 10. AD7874 IMD Plot

Peak Harmonic or Spurious Noise

Harmonic or Spurious Noise is defined as the ratio of the rms value of the next largest component in the ADC output spectrum (up to $f_s/2$ and excluding dc) to the rms value of the fundamental. Normally, the value of this specification will be determined by the largest harmonic in the spectrum, but for parts where the harmonics are buried in the noise floor the peak will be a noise peak.

AC Linearity Plot

When a sine wave of specified frequency is applied to the V_{IN} input of the AD7874 and several million samples are taken, a histogram showing the frequency of occurrence of each of the 4096 ADC codes can be generated. From this histogram data it is possible to generate an ac integral linearity plot as shown in Figure 11. This shows very good integral linearity performance from the AD7874 at an input frequency of 10 kHz. The absence of large spikes in the plot shows good differential linearity. Simplified versions of the formulae used are outlined below.

$$INL(i) = \left[\frac{(V(i) - V(o)) \cdot 4096}{V(f_s) - V(o)} \right] - i$$

where $INL(i)$ is the integral linearity at code i . $V(f_s)$ and $V(o)$ are the estimated full-scale and offset transitions, and $V(i)$ is the estimated transition for the i^{th} code.

$V(i)$, the estimated code transition point is derived as follows:

$$V(i) = -A \cdot \text{Cos} \left[\frac{\pi \cdot \text{cum}(i)}{N} \right]$$

where A is the peak signal amplitude, N is the number of histogram samples

$$\text{and } \text{cum}(i) = \sum_{n=0}^i V(n) \text{ occurrences}$$

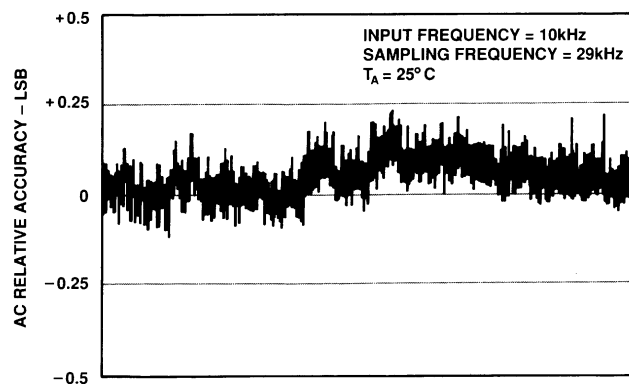

Figure 11. AD7874 AC INL Plot

AD7874

MICROPROCESSOR INTERFACING

The AD7874 high speed bus timing allows direct interfacing to DSP processors as well as modern 16-bit microprocessors. Suitable microprocessor interfaces are shown in Figures 12 through 16.

AD7874-ADSP-2100 Interface

Figure 12 shows an interface between the AD7874 and the ADSP-2100. Conversion is initiated using a timer which allows very accurate control of the sampling instant on all four channels. The AD7874 $\overline{\text{INT}}$ line provides an interrupt to the ADSP-2100 when conversion is completed on all four channels. The four conversion results can then be read from the AD7874 using four successive reads to the same memory address. The following instruction reads one of the four results (this instruction is repeated four times to read all four results in sequence):

MR0 = DM(ADC)

where MR0 is the ADSP-2100 MR0 register and ADC is the AD7874 address.

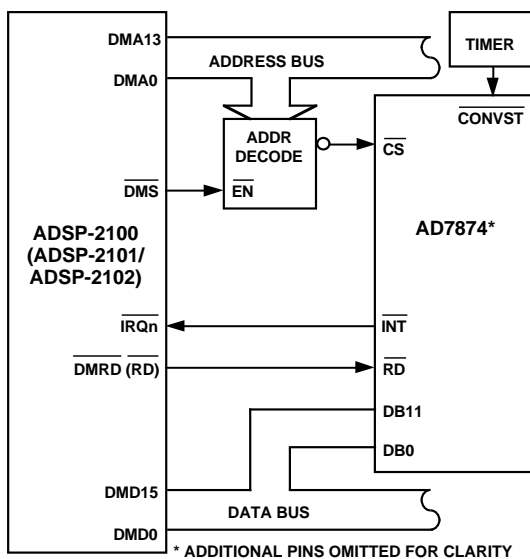

Figure 12. AD7874-ADSP-2100 Interface

AD7874-ADSP-2101/ADSP-2102 Interface

The interface outlined in Figure 12 also forms the basis for an interface between the AD7874 and the ADSP-2101/ADSP-2102. The READ line of the ADSP-2101/ADSP-2102 is labeled $\overline{\text{RD}}$. In this interface, the $\overline{\text{RD}}$ pulse width of the processor can be programmed using the Data Memory Wait State Control Register. The instruction used to read one of the four results is as outlined for the ADSP-2100.

AD7874-TMS32010 Interface

An interface between the AD7874 and the TMS32010 is shown in Figure 13. Once again the conversion is initiated using an external timer and the TMS32010 is interrupted when all four conversions have been completed. The following instruction is used to read the conversion results from the AD7874:

IN D,ADC

where D is Data Memory address and ADC is the AD7874 address.

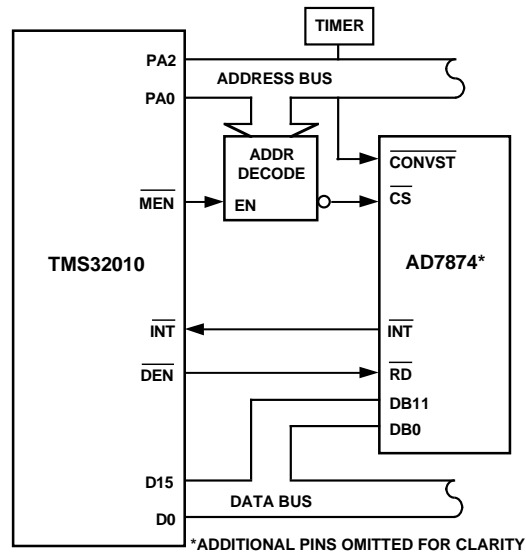

Figure 13. AD7874-TMS32010 Interface

AD7874-TMS320C25 Interface

Figure 14 shows an interface between the AD7874 and the TMS320C25. As with the two previous interfaces, conversion is initiated with a timer and the processor is interrupted when the conversion sequence is completed. The TMS320C25 does not have a separate $\overline{\text{RD}}$ output to drive the AD7874 $\overline{\text{RD}}$ input directly. This has to be generated from the processor STRB and R/W outputs with the addition of some logic gates. The $\overline{\text{RD}}$ signal is OR-gated with the MSC signal to provide the one WAIT state required in the read cycle for correct interface timing. Conversion results are read from the AD7874 using the following instruction:

IN D,ADC

where D is Data Memory address and ADC is the AD7874 address.

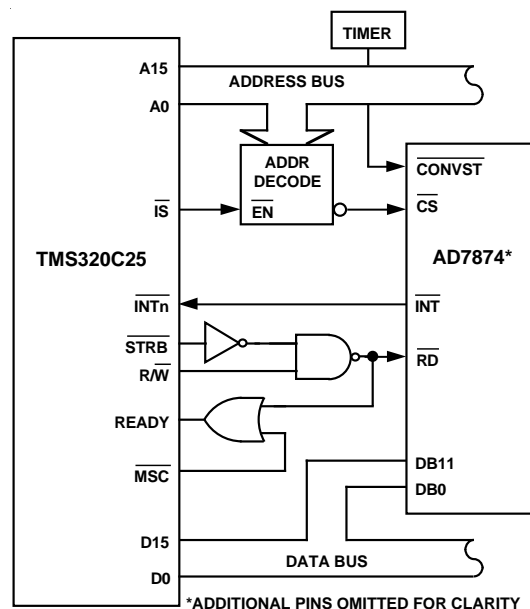

Figure 14. AD7874-TMS320C25 Interface

Some applications may require that the conversion is initiated by the microprocessor rather than an external timer. One option is to decode the AD7874 $\overline{\text{CONVST}}$ from the address bus so that a write operation starts a conversion. Data is read at the end of the conversion sequence as before. Figure 16 shows an example of initiating conversion using this method. Note that for all interfaces, a read operation should not be attempted during conversion.

AD7874-MC68000 Interface

An interface between the AD7874 and the MC68000 is shown in Figure 15. As before, conversion is initiated using an external timer. The AD7874 $\overline{\text{INT}}$ line can be used to interrupt the processor or, alternatively, software delays can ensure that conversion has been completed before a read to the AD7874 is attempted. Because of the nature of its interrupts, the 68000 requires additional logic (not shown in Figure 15) to allow it to be interrupted correctly. For further information on 68000 interrupts, consult the 68000 users manual.

The MC68000 $\overline{\text{AS}}$ and $\text{R}/\overline{\text{W}}$ outputs are used to generate a separate $\overline{\text{RD}}$ input signal for the AD7874. $\overline{\text{CS}}$ is used to drive the 68000 $\overline{\text{DTACK}}$ input to allow the processor to execute a normal read operation to the AD7874. The conversion results are read using the following 68000 instruction:

```
MOVE.W ADC,D0
```

where D0 is the 68000 D0 register and ADC is the AD7874 address.

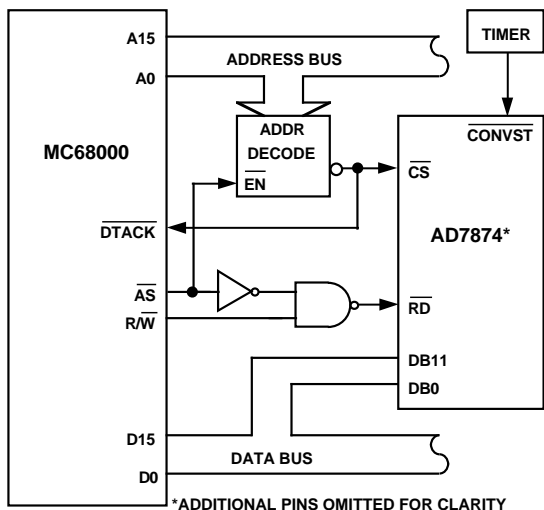

Figure 15. AD7874-MC68000 Interface

AD7874-8086 Interface

Figure 16 shows an interface between the AD7874 and the 8086 microprocessor. Unlike the previous interface examples, the microprocessor initiates conversion. This is achieved by gating the 8086 $\overline{\text{WR}}$ signal with a decoded address output (different to the AD7874 $\overline{\text{CS}}$ address). The AD7874 $\overline{\text{INT}}$ line is used to interrupt the microprocessor when the conversion sequence is completed. Data is read from the AD7874 using the following instruction:

```
MOV AX,ADC
```

where AX is the 8086 accumulator and ADC is the AD7874 address.

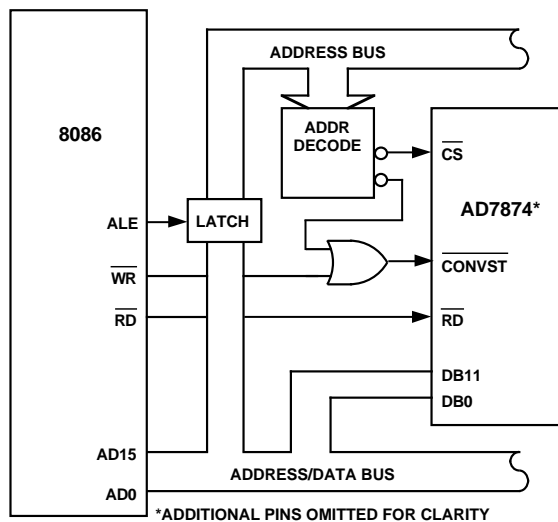

Figure 16. AD7874-8086 Interface

AD7874

APPLICATIONS

Vector Motor Control

The current drawn by a motor can be split into two components: one produces torque and the other produces magnetic flux. For optimal performance of the motor, these two components should be controlled independently. In conventional methods of controlling a three-phase motor, the current (or voltage) supplied to the motor and the frequency of the drive are the basic control variables. However, both the torque and flux are functions of current (or voltage) and frequency. This coupling effect can reduce the performance of the motor because, for example, if the torque is increased by increasing the frequency, the flux tends to decrease.

Vector control of an ac motor involves controlling phase in addition to drive and current frequency. Controlling the phase of the motor requires feedback information on the position of the rotor relative to the rotating magnetic field in the motor. Using this information, a vector controller mathematically transforms the three phase drive currents into separate torque and flux components. The AD7874, with its four-channel simultaneous sampling capability, is ideally suited for use in vector motor control applications.

A block diagram of a vector motor control application using the AD7874 is shown in Figure 17. The position of the field is derived by determining the current in each phase of the motor. Only two phase currents need to be measured because the third can be calculated if two phases are known. Channel 1 and Channel 2 of the AD7874 are used to digitize this information.

Simultaneous sampling is critical to maintain the relative phase information between the two channels. A current sensing isolation amplifier, transformer or Hall effect sensor is used between the motor and the AD7874. Rotor information is obtained by measuring the voltage from two of the inputs to the motor. Channel 3 and Channel 4 of the AD7874 are used to obtain this information. Once again the relative phase of the two channels is important. A DSP microprocessor is used to perform the mathematical transformations and control loop calculations on the information fed back by the AD7874.

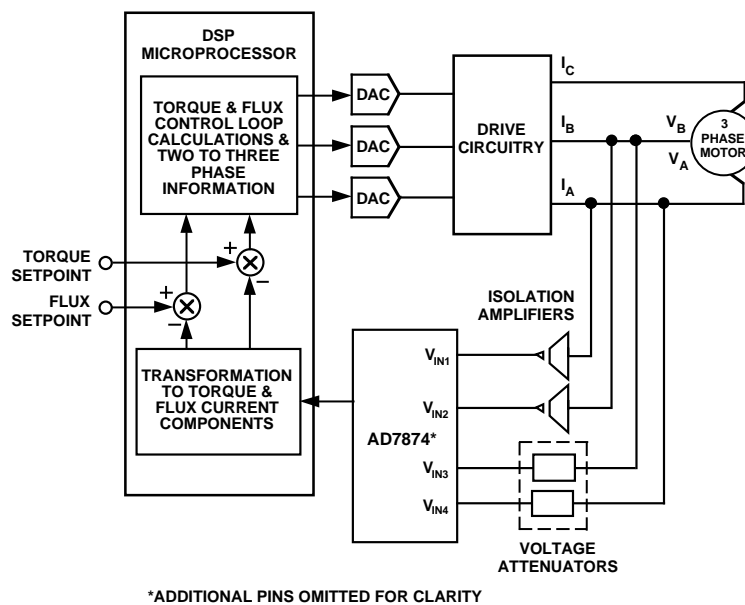

Figure 17. Vector Motor Control Using the AD7874

MULTIPLE AD7874s

Figure 18 shows a system where a number of AD7874s can be configured to handle multiple input channels. This type of configuration is common in applications such as sonar, radar, etc. The AD7874 is specified with maximum and minimum limits on aperture delay. This means that the user knows the maximum difference in the sampling instant between all channels. This allows the user to maintain relative phase information between the different channels.

A common read signal from the microprocessor drives the \overline{RD} input of all AD7874s. Each AD7874 is designated a unique address selected by the address decoder. The reference output of AD7874 number 1 is used to drive the reference input of all other AD7874s in the circuit shown in Figure 18. One REF OUT pin can drive several AD7874 REF IN pins. Alternatively, an external or system reference can be used to drive all REF IN inputs. A common reference ensures good full-scale tracking between all channels.

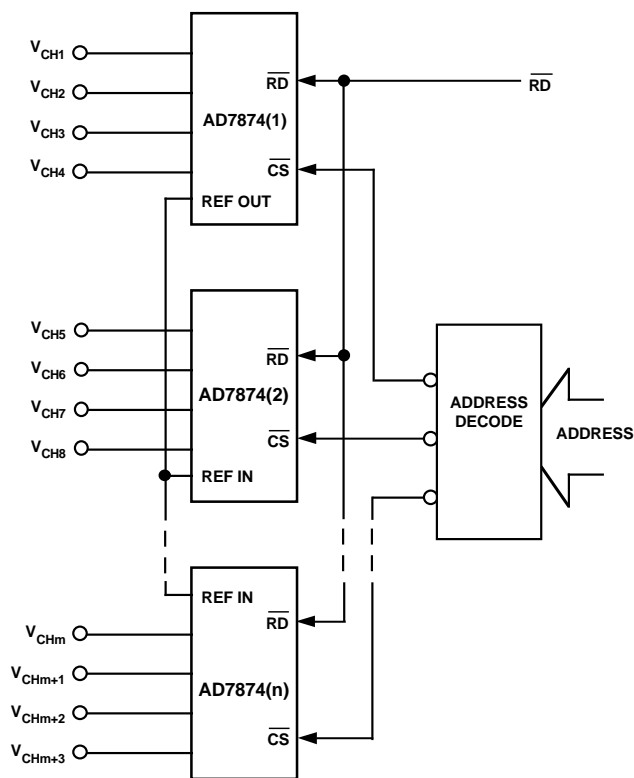

Figure 18. Multiple AD7874s in Multichannel System

DATA ACQUISITION BOARD

Figure 20 shows the AD7874 in a data acquisition circuit. The corresponding printed circuit board (PCB) layout and silkscreen are shown in Figures 21 to 23. A 26-contact IDC connector provides for a microprocessor connection to the board.

A component grid is provided near the analog inputs on the PCB which may be used to provide antialiasing filters for the analog input channels or to provide signal conditioning circuitry. To facilitate this option, four shorting plugs (labeled LK1 to LK4 on the PCB) are provided on the analog inputs, one plug per input. If the shorting plug for a particular channel is used,

the input signal connects to the buffer amplifier driving the analog input of the ADC. If the shorting plug is omitted, a wire link can be used to connect the input signal to the PCB component grid.

Microprocessor connections to the board are made via a 26-contact IDC connector, SKT8, the pinout for which is shown in Figure 19. This connector contains all data, control and status signals of the AD7874 (with the exception of the CLK input and the \overline{CONVST} input which are provided via SKT5 and SKT7, respectively). It also contains decoded $\overline{R/W}$ and \overline{STRB} inputs which are necessary for TMS32020 interfacing (and also for 68000 interfacing although pin labels on the 68000 are different). Note that the AD7874 \overline{CS} input must be decoded prior to the AD7874 evaluation board.

SKT1, SKT2, SKT3 and SKT4 provide the inputs for V_{IN1} , V_{IN2} , V_{IN3} , V_{IN4} respectively. Assuming LK1 to LK4 are in place, these input signals are fed to four buffer amplifiers, IC1, before being applied to the AD7874. The use of an external clock source is optional; there is a shorting plug (LK5) on the AD7874 CLK input which must be connected to either -5 V (for the ADCs own internal clock) or to SKT5. SKT6 and SKT7 provide the reference and \overline{CONVST} inputs respectively. Shorting plug LK6 provides the option of using the external reference or the ADCs own internal reference.

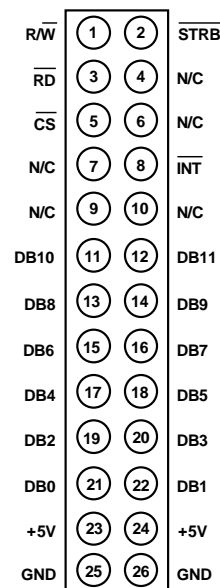

Figure 19. SKT8, IDC Connector Pinout

POWER SUPPLY CONNECTIONS

The PCB requires two analog power supplies and one 5 V digital supply. The analog supplies are labeled $V+$ and $V-$ and the range for both supplies is 12 V to 15 V (see silkscreen in Figure 23). Connection to the 5 V digital supply is made via SKT8.

The +5 V supply and the -5 V supply required by the AD7874 are generated from voltage regulators (IC3 and IC4) on the $V+$ and $V-$ supplies.

AD7874

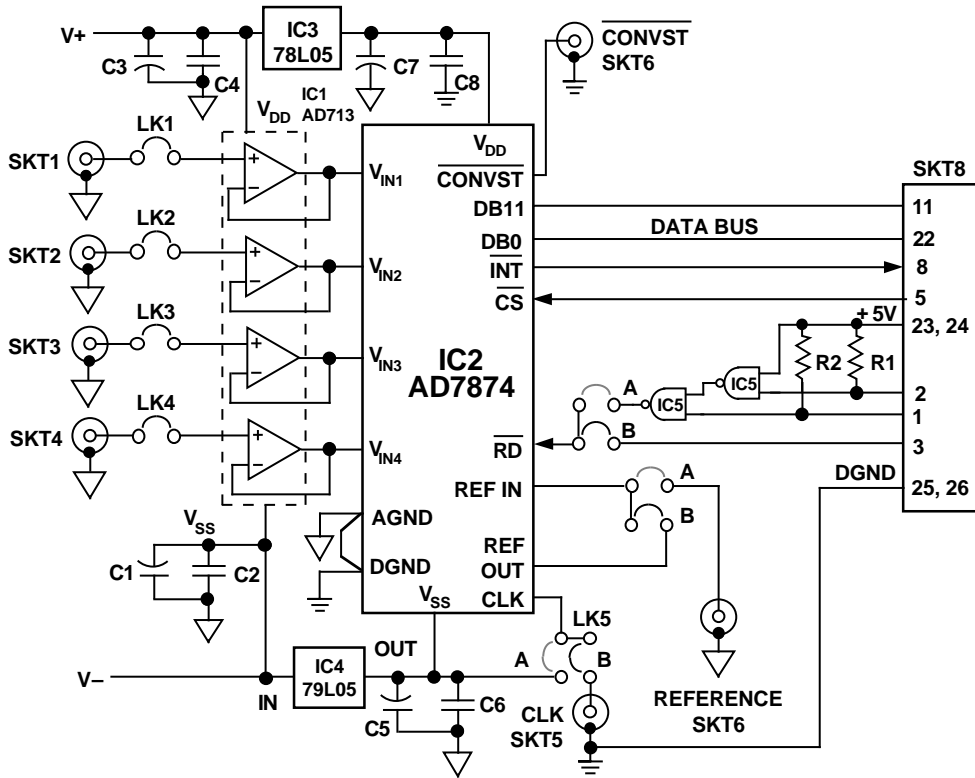

Figure 20. Data Acquisition Circuit Using the AD7874

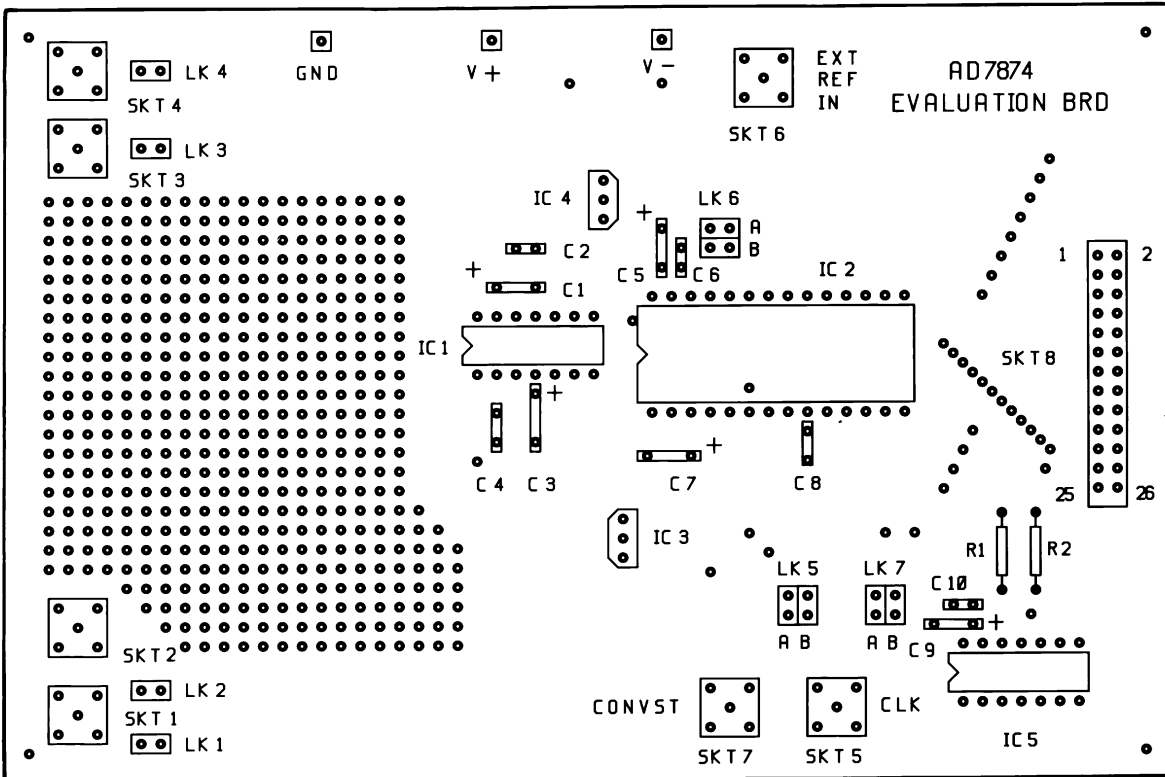

Figure 21. PCB Silkscreen for Figure 20

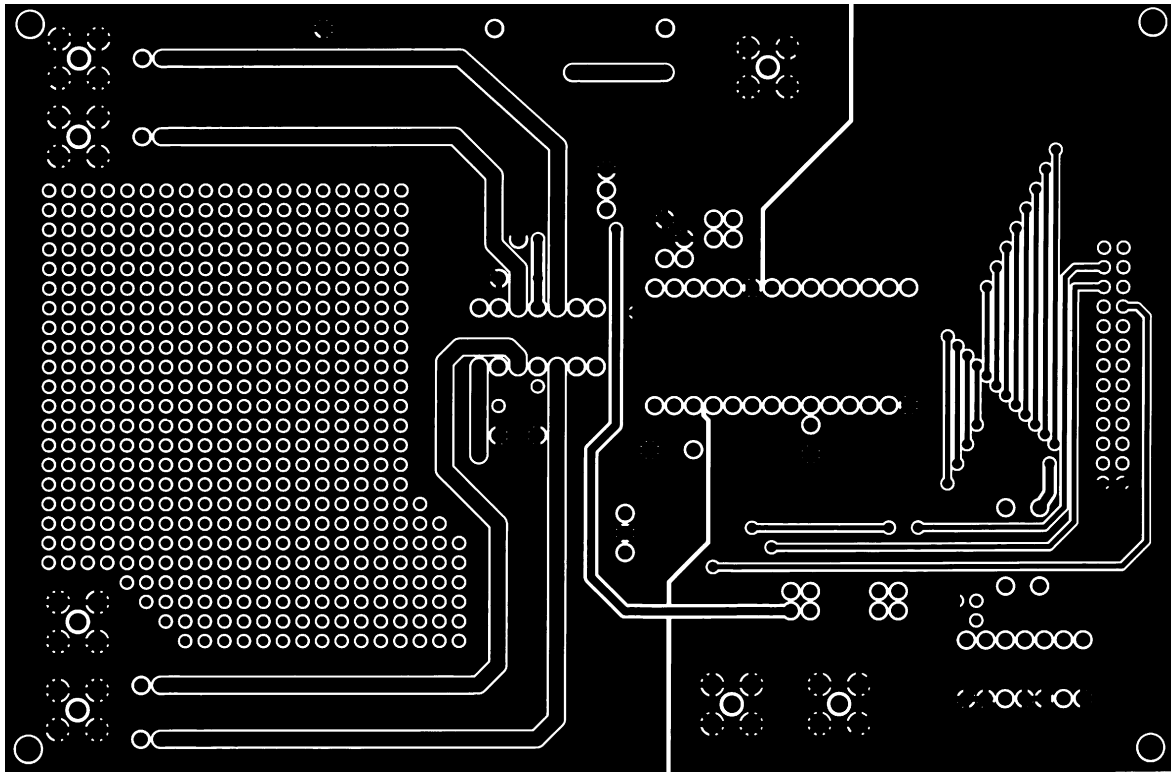

Figure 22. PCB Component Side Layout for the Circuit of Figure 20

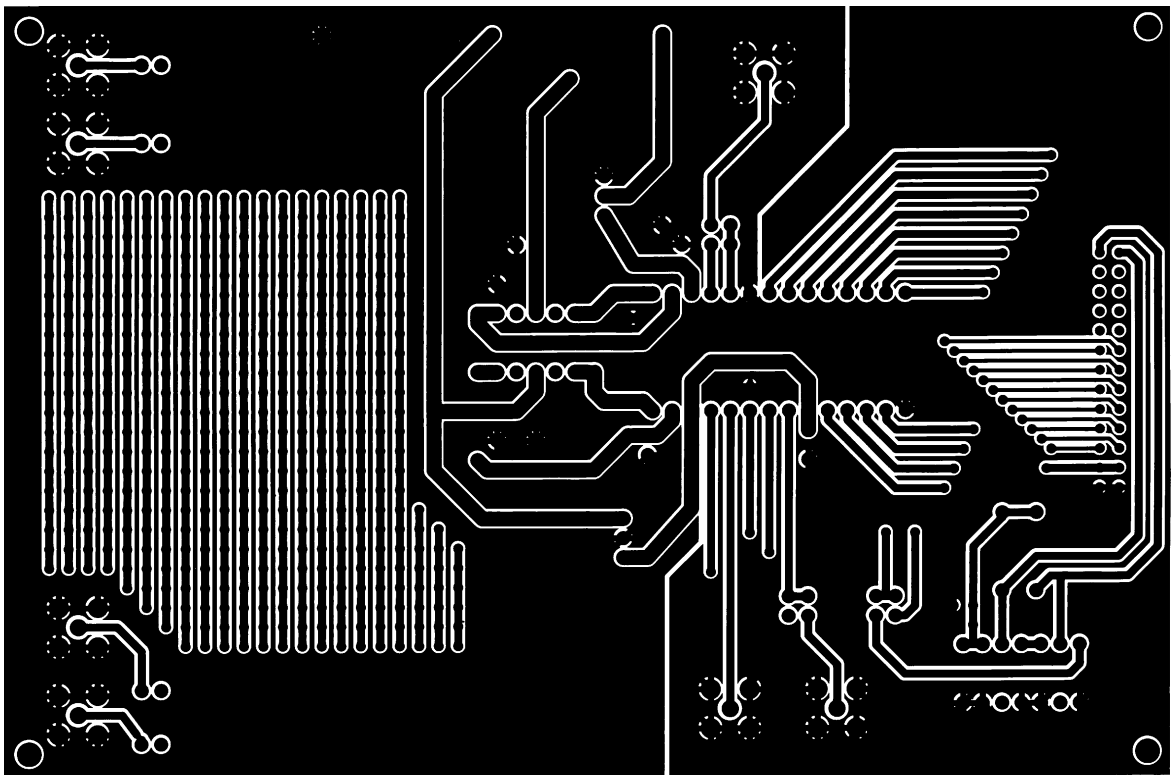

Figure 23. PCB Solder Side Layout for the Circuit of Figure 20

AD7874

SHORTING PLUG OPTIONS

There are seven shorting plug options which must be set before using the board. These are outlined below:

- LK1-LK4 Connects the analog inputs to the buffer amplifiers. The analog inputs may also be connected to a component grid for signal conditioning.
- LK5 Selects either the AD7874 internal clock or an external clock source.
- LK6 Selects either the AD7874 internal reference or an external reference source.
- LK7 Connects the AD7874 \overline{RD} input directly to the \overline{RD} input of SKT8 or to a decoded \overline{STRB} and R/\overline{W} input. This shorting plug setting depends on the microprocessor, e.g., the TMS32020 and 68000 require a decoded \overline{RD} signal.

COMPONENT LIST

- IC1 AD713 Quad Op Amp
- IC2 AD7874 Analog-to-Digital Converter
- IC3 MC78L05 +5 V Regulator
- IC4 MC79L05 -5 V Regulator
- IC5 74HC00 Quad NAND Gate
- C1, C3, C5, C7, C9 10 μ F Capacitors
- C2, C4, C6, C8, C10 0.1 μ F Capacitors
- R1, R2 10 k Ω Pull-Up Resistors
- LK1, LK2, LK3 Shorting Plugs
- LK4, LK5, LK6
- LK7
- SKT1, SKT2, SKT3, SKT4, SKT5, SKT6, SKT7 BNC Sockets
- SKT8 26-Contact (2-Row) IDC Connector

C1388a-5-5/91

OUTLINE DIMENSIONS

Dimensions shown in inches and (mm).

Plastic (N-28)

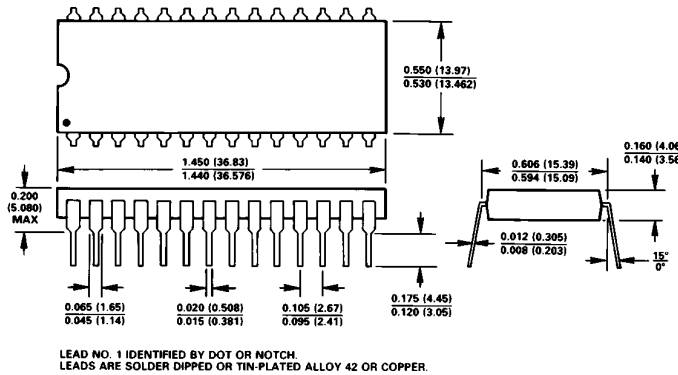

SOIC (R-28)

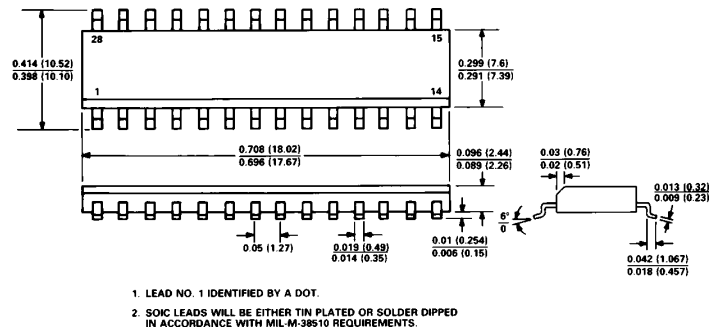

Cerdip (Q-28)

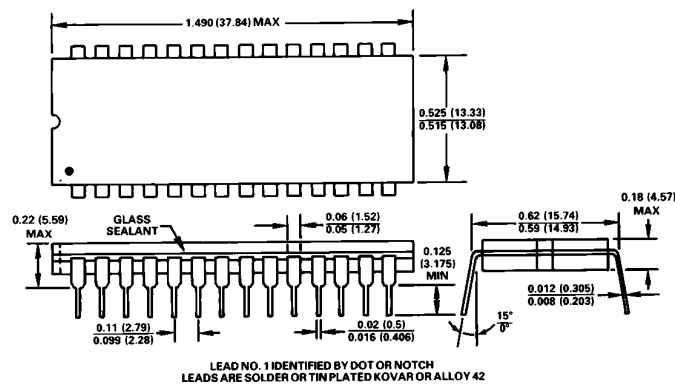

LCCC (E-28A)

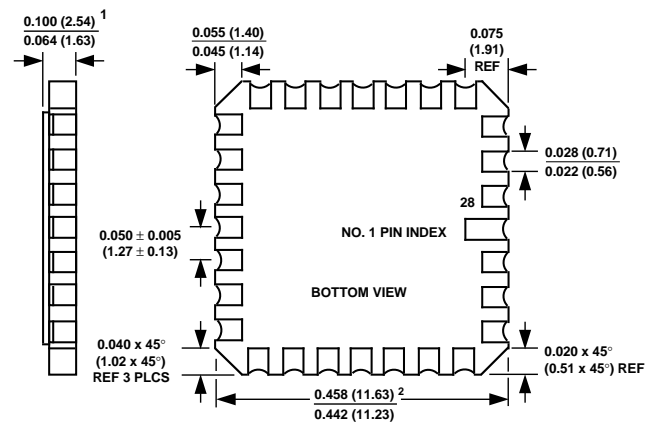

PRINTED IN U.S.A.