



- 2.0mm Pitch, Rated Current: 2A max
- Fully Waterproof Solution available in 2, 3, 4, or 6 Positions (2 and 3 Positions Only for Wire to Board)
- Available in Wire-to-Wire and Wire-to-Board Options
- Seals preassembled into housing; no external sealing required
- True Crimp and Poke Solution
- Waterproofing cap available to cover holes of wire seal
- Available with wire already installed
- Waterproof Grade IP67 Certified



Specifications:

No. of Positions	2, 3, 4, or 6P
Pitch	2.0mm
Rated Voltage	250V
Rated Current	2A max
Withstanding Voltage	1000V AC (rms)
Contact Resistance	10 mΩ max
Insulation Resistance	1000 MΩ min./DC500V
Temperature Range	-40°C to +105°C
PCB Thickness	1.6mm

Materials:

Crimp & Poke	Housing	PBT, UL 94V-0
	Contact	Phosphor Bronze
PCB Header	Housing	PBT with Glass, UL 94V-0
	Contact	Brass
Contact Plating	Tin Plating	
Wire & Housing Seals	Silicone Rubber	
Waterproofing Cap	PBT, UL 94V-0	

Waterproofing Cap:

Part No
566-200-100



Crimp Contact:

Male Contact (Pin)			
Part No	AWG#	Ins. Dia.	Pcs/Reel
566-290-711	22-28	Ø1.0~Ø1.5	12,000

**Crimp Contacts are also available in strips of 60pcs. Contact EDAC for more information.

Female Contact (Socket)			
Part No	AWG#	Ins. Dia.	Pcs/Reel
566-290-721	22-28	Ø1.0~Ø1.5	12,000

**Wire seals and housing seals are already pre-assembled in the connector.

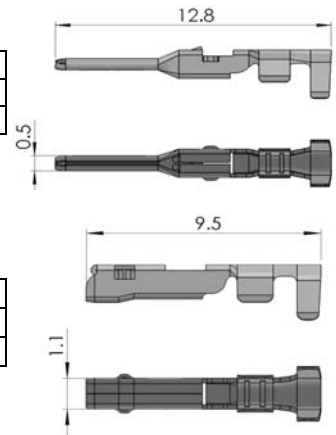

Rear Gasket (Wire Seal):

Applicable Contact	Wire O.D.	Color
566-290-711	Ø1.00 to Ø1.25	Light Blue
566-290-721	Ø1.25 to Ø1.50	Orange

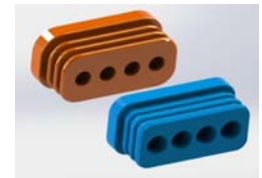

Ordering Code: **566-002-000-710**

SERIES: _____
566, WIRE TO WIRE
WIRE TO BOARD

NO. OF CONTACTS: _____
002 - 2 CONTACTS
003 - 3 CONTACTS
004 - 4 CONTACTS
006 - 6 CONTACTS

CONTACT CODE: _____
000 - NO CONTACTS (ONLY FOR CRIMP CONTACTS)
421 - BOARD MOUNT CONTACTS (PCB) ONLY FOR
2 & 3 PIN SIZE

STYLE: _____
701 - BLACK MALE HOUSING (ONLY FOR BOARD MOUNT CONTACTS)
710 - BLACK MALE HOUSING FOR WIRE INSULATION Ø1.00 TO Ø1.25
711 - BLACK MALE HOUSING FOR WIRE INSULATION Ø1.25 TO Ø1.50
810 - BLACK FEMALE HOUSING FOR WIRE INSULATION Ø1.00 TO Ø1.25
811 - BLACK FEMALE HOUSING FOR WIRE INSULATION Ø1.25 TO Ø1.50

Assembly Layout

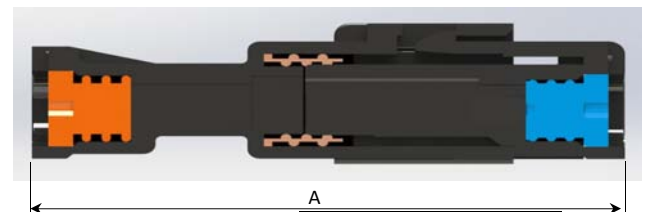

PIN SIZE	A (mm) LENGTH
2P, 3P, 4P	28.85
6P	29.05

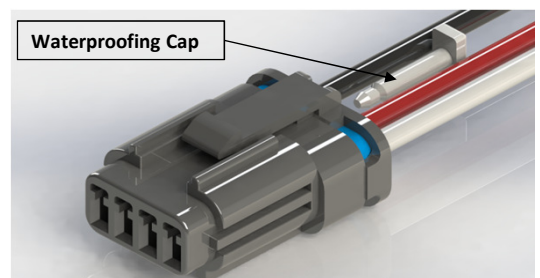

Male Housing:

566-002-000-XXX



566-003-000-XXX



566-004-000-XXX

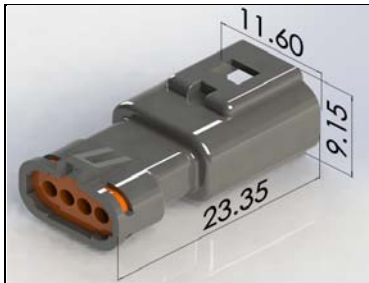

566-006-000-XXX



Female Housing:

566-002-000-XXX

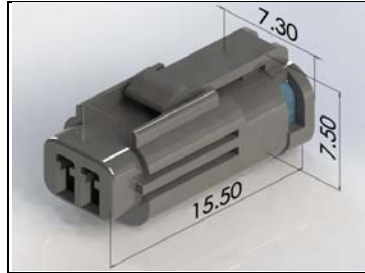

566-003-000-XXX

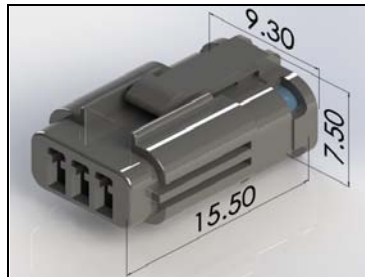

566-004-000-XXX

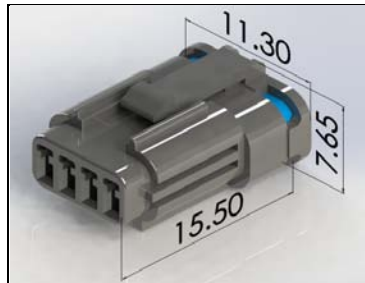

566-006-000-XXX



PCB Header

566-002-421-701

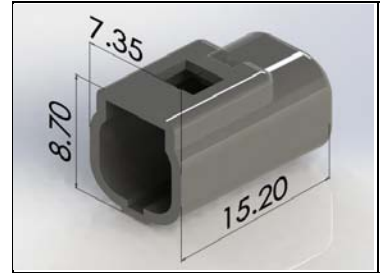

566-003-421-701

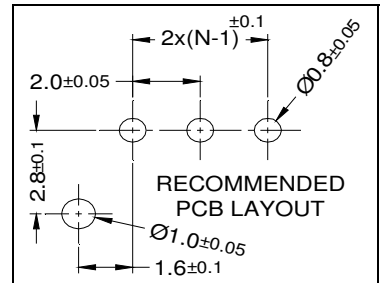
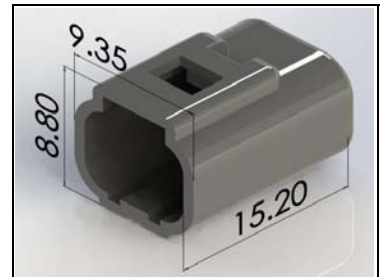

Male Housing:

Ø Wire Insulation	Housing Color	XXX
Ø1.00 to Ø1.25	Black	710
Ø1.25 to Ø1.50	Black	711

Female Housing:

Ø Wire Insulation	Housing Color	XXX
Ø1.00 to Ø1.25	Black	810
Ø1.25 to Ø1.50	Black	811