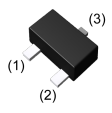
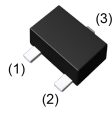

Parameter	Value
$V_{CEO}$	-30V
$I_C$	-0.5A

●Outline

<p>EMT3F</p>  <p>2SAR502EB SOT-416FL</p>	<p>UMT3F</p>  <p>2SAR502UB SOT-323FL</p>
--	---

●Features

- 1)General purpose.
- 2)Complementary NPN types :  
2SCR502EB(EMT3F)/2SCR502UB(UMT3F)
- 3)Collector current is large.
- 4)Low  $V_{CE(sat)}$ .

●Inner circuit

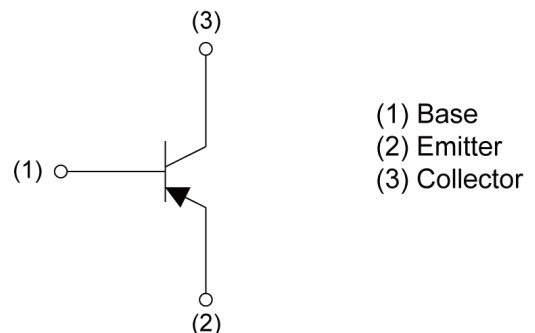

●Application

LOW FREQUENCY AMPLIFIER

●Packaging specifications

Part No.	Package	Package size	Taping code	Reel size (mm)	Tape width (mm)	Basic ordering unit.(pcs)	Marking
2SAR502EB	EMT3F	1616	TL	180	8	3000	LT
2SAR502UB	UMT3F	2021	TL	180	8	3000	LT

● **Absolute maximum ratings** ( $T_a = 25^\circ\text{C}$ )

Parameter		Symbol	Values	Unit
Collector-base voltage		$V_{\text{CBO}}$	-30	V
Collector-emitter voltage		$V_{\text{CEO}}$	-30	V
Emitter-base voltage		$V_{\text{EBO}}$	-6	V
Collector current		$I_{\text{C}}^{*1}$	-0.5	A
		$I_{\text{CP}}^{*2}$	-1	A
Base current		$I_{\text{B}}$	-0.15	A
Power dissipation	2SAR502EB	$P_{\text{D}}^{*3}$	150	mW
	2SAR502UB		200	
Junction temperature		$T_{\text{j}}$	150	$^\circ\text{C}$
Range of storage temperature		$T_{\text{stg}}$	-55 to +150	$^\circ\text{C}$

● **Electrical characteristics** ( $T_a = 25^\circ\text{C}$ )

Parameter	Symbol	Conditions	Values			Unit
			Min.	Typ.	Max.	
Collector-base breakdown voltage	$BV_{\text{CBO}}$	$I_{\text{C}} = -100\mu\text{A}$	-30	-	-	V
Collector-emitter breakdown voltage	$BV_{\text{CEO}}$	$I_{\text{C}} = -1\text{mA}$	-30	-	-	V
Emitter-base breakdown voltage	$BV_{\text{EBO}}$	$I_{\text{E}} = -100\mu\text{A}$	-6	-	-	V
Collector cut-off current	$I_{\text{CBO}}$	$V_{\text{CB}} = -25\text{V}$	-	-	-200	nA
Emitter cut-off current	$I_{\text{EBO}}$	$V_{\text{EB}} = -4\text{V}$	-	-	-200	nA
Collector-emitter saturation voltage	$V_{\text{CE(sat)}}$	$I_{\text{C}} = -200\text{mA}$ , $I_{\text{B}} = -10\text{mA}$	-	-150	-400	mV
DC current gain	$h_{\text{FE}}$	$V_{\text{CE}} = -2\text{V}$ , $I_{\text{C}} = -100\text{mA}$	200	-	500	-
Transition frequency	$f_{\text{T}}^{*4}$	$V_{\text{CE}} = -10\text{V}$ , $I_{\text{E}} = 100\text{mA}$ , $f = 100\text{MHz}$	-	520	-	MHz
Output capacitance	$C_{\text{ob}}$	$V_{\text{CB}} = 10\text{V}$ , $I_{\text{E}} = 0\text{A}$ , $f = 1\text{MHz}$	-	4	-	pF

\*1 Limited by power dissipation.

\*2  $P_w=10\text{ms}$ , Single pulse.

\*3 Each terminal mounted on a reference land.

\*4 Pulsed

● Electrical characteristic curves ( $T_a = 25^\circ\text{C}$ )

Fig.1 Grounded Emitter Propagation Characteristics

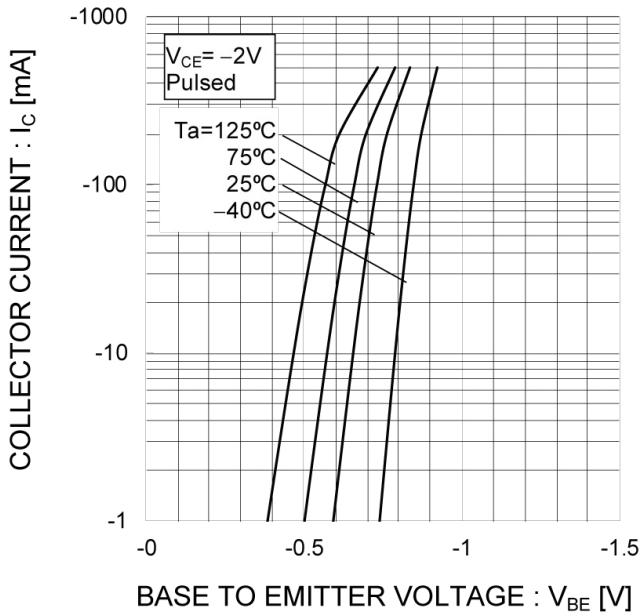

Fig.2 Typical Output Characteristics

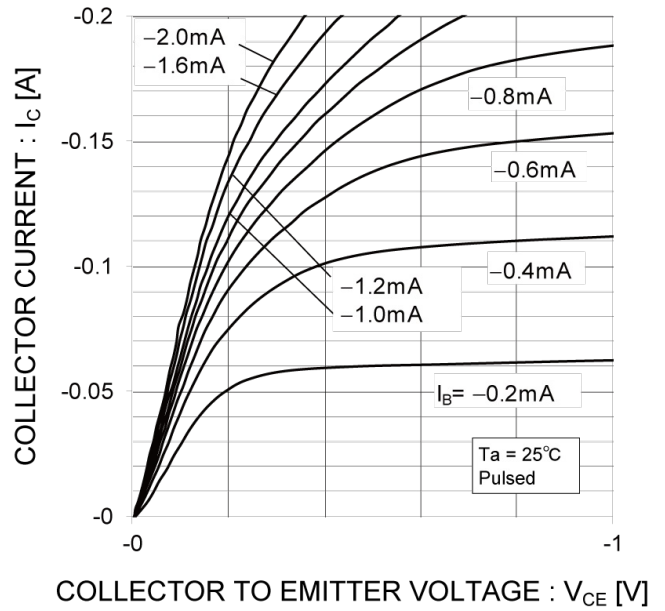

Fig.3 DC Current Gain vs. Collector Current(I)

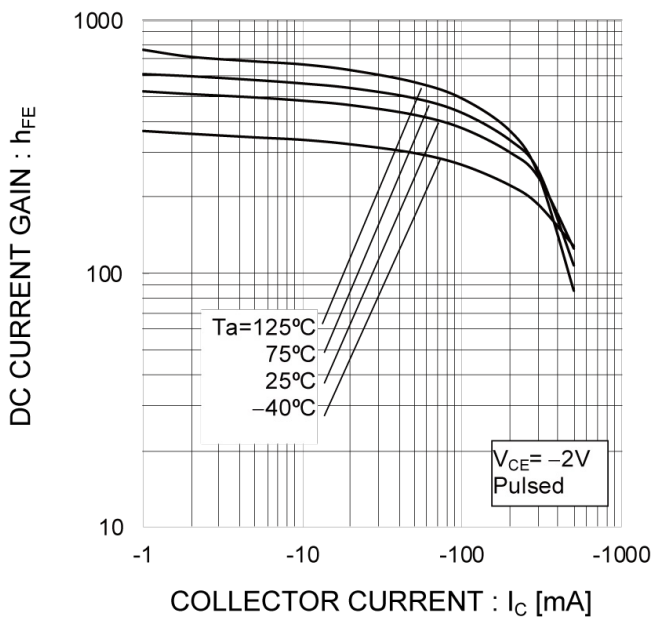
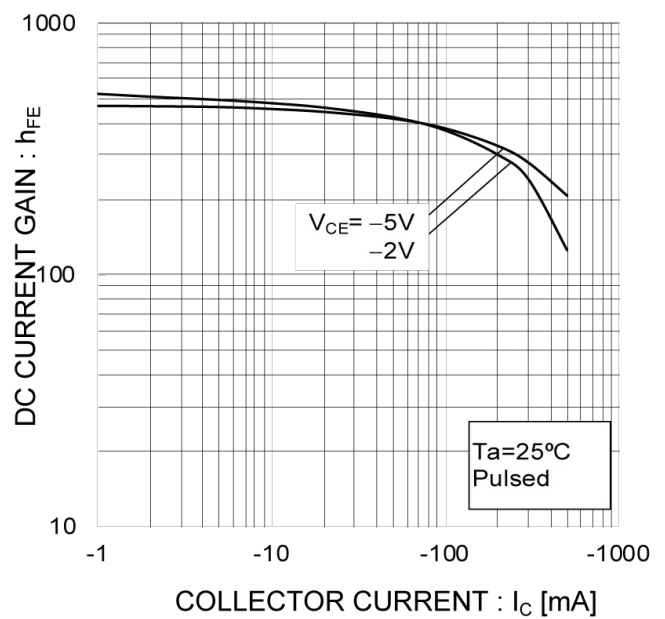

Fig.4 DC Current Gain vs. Collector Current(II)



● Electrical characteristic curves ( $T_a = 25^\circ\text{C}$ )

Fig.5 Collector-Emitter Saturation Voltage vs. Collector Current(I)

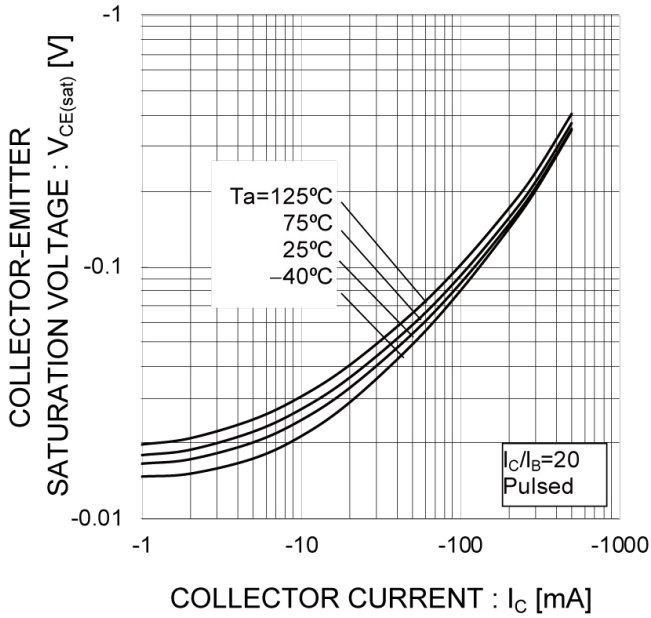

Fig.6 Collector-Emitter Saturation Voltage vs. Collector Current(II)

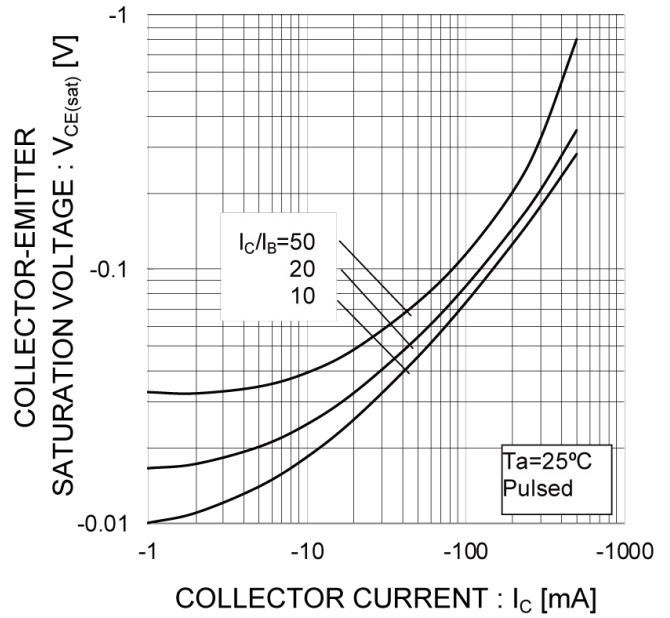

Fig.7 Base-Emitter Saturation Voltage vs. Collector Current

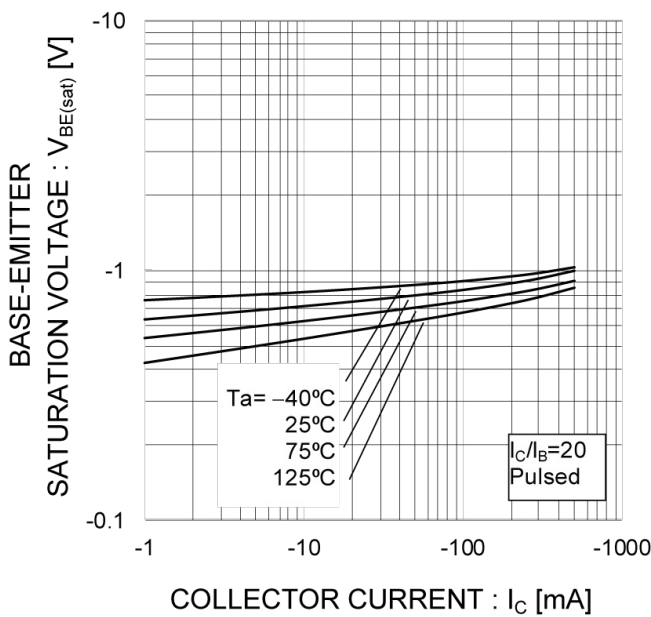
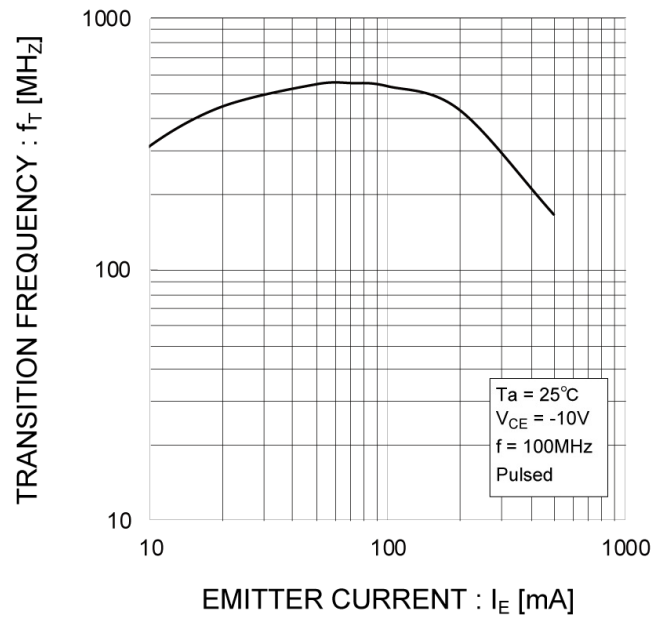

Fig.8 Gain Bandwidth Product vs. Emitter Current



● Electrical characteristic curves ( $T_a = 25^\circ\text{C}$ )

Fig.9 Emitter input capacitance vs. Emitter-Base Voltage Collector output capacitance vs. Collector-Base Voltage

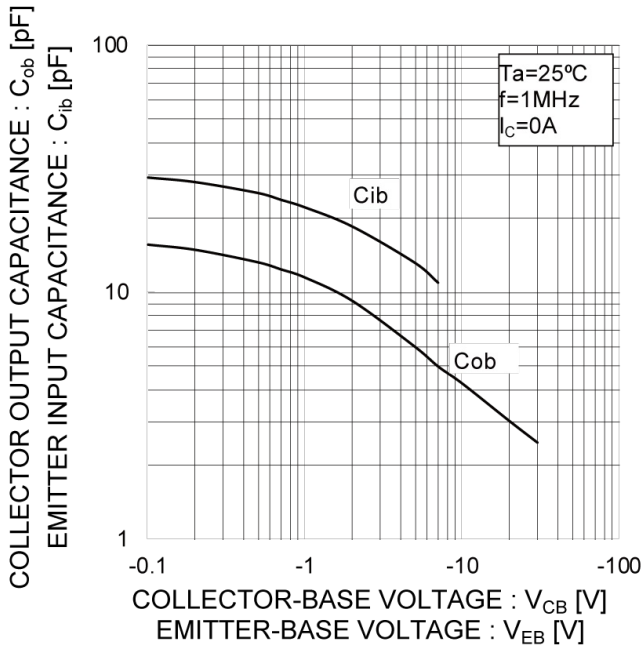

Fig.10 Safe Operating Area

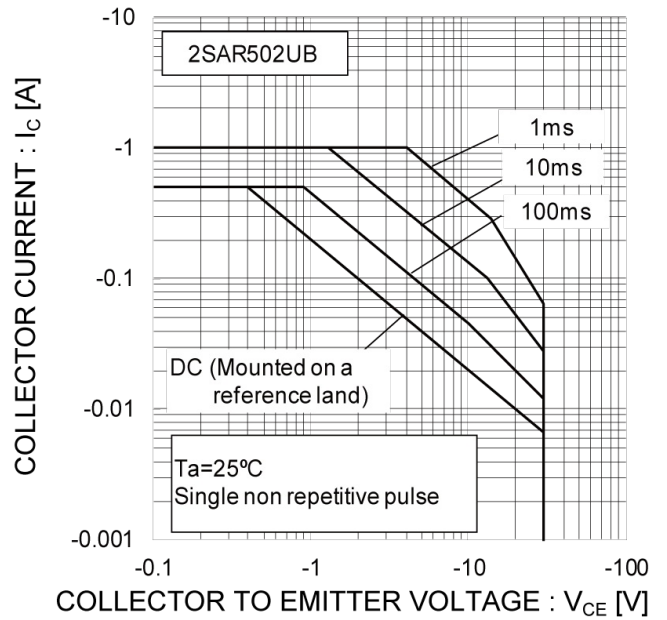
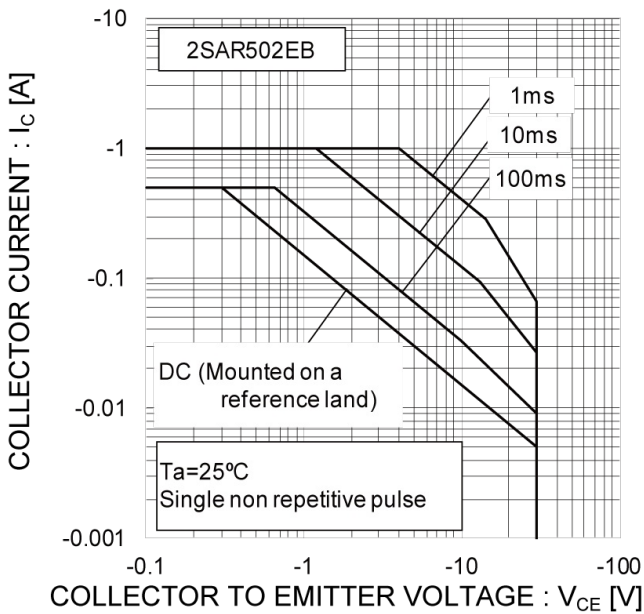

Fig.11 Safe Operating Area



●Dimensions

EMT3F



Pattern of terminal position areas  
[Not a recommended pattern of soldering pads]

DIM	MILIMETERS		INCHES	
	MIN	MAX	MIN	MAX
A	0.65	0.85	0.026	0.033
A1	0.00	0.10	0.000	0.004
A2	0.60	0.80	0.024	0.031
b	0.21	0.36	0.008	0.014
c	0.08	0.18	0.003	0.007
D	1.50	1.70	0.059	0.067
E	0.76	0.96	0.030	0.038
e	0.50		0.020	
HE	1.50	1.70	0.059	0.067
L	0.37		0.015	
Lp	0.35	0.55	0.014	0.022
x	-	0.10	-	0.004

DIM	MILIMETERS		INCHES	
	MIN	MAX	MIN	MAX
b2	-	0.46	-	0.018
e1	-	1.05	-	0.041
l1	-	0.65	-	0.026

Dimension in mm/inches

●Dimensions

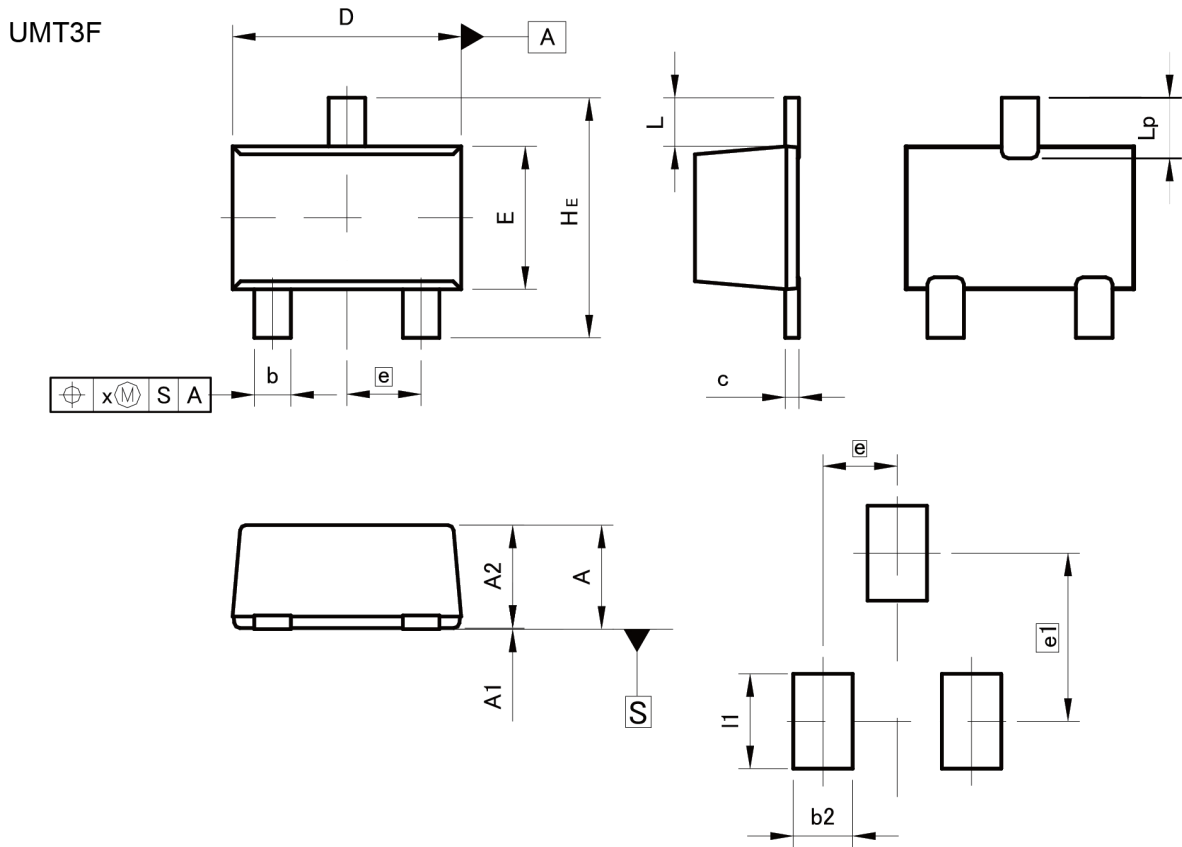

Pattern of terminal position areas  
[Not a recommended pattern of soldering pads]

DIM	MILIMETERS		INCHES	
	MIN	MAX	MIN	MAX
A	0.85	1.05	0.033	0.041
A1	0.00	0.10	0.000	0.004
A2	0.80	1.00	0.031	0.039
b	0.27	0.42	0.011	0.017
c	0.08	0.18	0.003	0.007
D	1.90	2.10	0.075	0.083
E	1.15	1.35	0.045	0.053
e	0.65		0.026	
HE	2.00	2.20	0.079	0.087
L	0.43		0.017	
Lp	0.43	0.63	0.017	0.025
x	-	0.10	-	0.004

DIM	MILIMETERS		INCHES	
	MIN	MAX	MIN	MAX
b2	-	0.52	-	0.020
e1	1.47		0.058	
l1	-	0.83	-	0.033

Dimension in mm/inches

## Notes

- 1) The information contained herein is subject to change without notice.
- 2) Before you use our Products, please contact our sales representative and verify the latest specifications :
- 3) Although ROHM is continuously working to improve product reliability and quality, semiconductors can break down and malfunction due to various factors. Therefore, in order to prevent personal injury or fire arising from failure, please take safety measures such as complying with the derating characteristics, implementing redundant and fire prevention designs, and utilizing backups and fail-safe procedures. ROHM shall have no responsibility for any damages arising out of the use of our Products beyond the rating specified by ROHM.
- 4) Examples of application circuits, circuit constants and any other information contained herein are provided only to illustrate the standard usage and operations of the Products. The peripheral conditions must be taken into account when designing circuits for mass production.
- 5) The technical information specified herein is intended only to show the typical functions of and examples of application circuits for the Products. ROHM does not grant you, explicitly or implicitly, any license to use or exercise intellectual property or other rights held by ROHM or any other parties. ROHM shall have no responsibility whatsoever for any dispute arising out of the use of such technical information.
- 6) The Products are intended for use in general electronic equipment (i.e. AV/OA devices, communication, consumer systems, gaming/entertainment sets) as well as the applications indicated in this document.
- 7) The Products specified in this document are not designed to be radiation tolerant.
- 8) For use of our Products in applications requiring a high degree of reliability (as exemplified below), please contact and consult with a ROHM representative : transportation equipment (i.e. cars, ships, trains), primary communication equipment, traffic lights, fire/crime prevention, safety equipment, medical systems, servers, solar cells, and power transmission systems.
- 9) Do not use our Products in applications requiring extremely high reliability, such as aerospace equipment, nuclear power control systems, and submarine repeaters.
- 10) ROHM shall have no responsibility for any damages or injury arising from non-compliance with the recommended usage conditions and specifications contained herein.
- 11) ROHM has used reasonable care to ensure the accuracy of the information contained in this document. However, ROHM does not warrants that such information is error-free, and ROHM shall have no responsibility for any damages arising from any inaccuracy or misprint of such information.
- 12) Please use the Products in accordance with any applicable environmental laws and regulations, such as the RoHS Directive. For more details, including RoHS compatibility, please contact a ROHM sales office. ROHM shall have no responsibility for any damages or losses resulting non-compliance with any applicable laws or regulations.
- 13) When providing our Products and technologies contained in this document to other countries, you must abide by the procedures and provisions stipulated in all applicable export laws and regulations, including without limitation the US Export Administration Regulations and the Foreign Exchange and Foreign Trade Act.
- 14) This document, in part or in whole, may not be reprinted or reproduced without prior consent of ROHM.



Thank you for your accessing to ROHM product informations.  
More detail product informations and catalogs are available, please contact us.

**ROHM Customer Support System**

<http://www.rohm.com/contact/>