

## 2N6344A, 2N6348A, 2N6349A

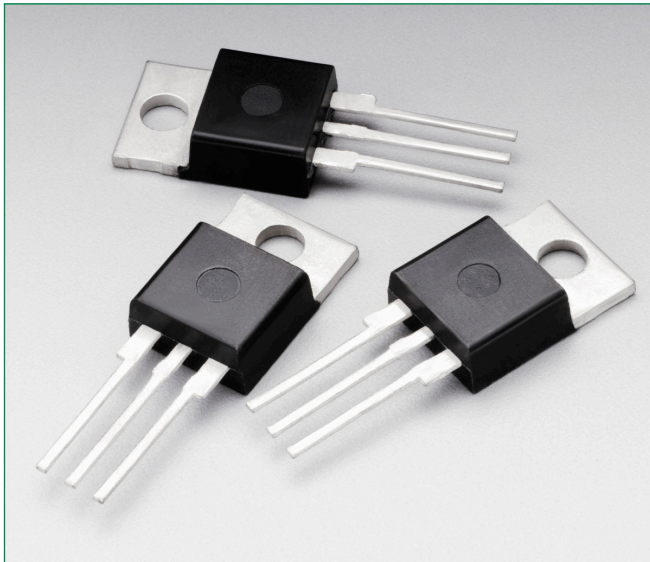

### Description

Designed primarily for full-wave AC control applications, such as light dimmers, motor controls, heating controls and power supplies; or wherever full-wave silicon gate controlled solid-state devices are needed. Triac type thyristors switch from a blocking to a conducting state for either polarity of applied anode voltage with positive or negative gate triggering.

### Features

- Blocking Voltage to 800 V
- All Diffused and Glass Passivated Junctions for Greater Parameter Uniformity and Stability
- Small, Rugged, Thermowatt Construction for Low Thermal Resistance, High Heat Dissipation and Durability
- Gate Triggering Guaranteed in all Four Quadrants
- For 400 Hz Operation, Consult Factory
- 8.0 A Devices Available as 2N6344 thru 2N6349
- Pb-Free Package is Available

### Pin Out

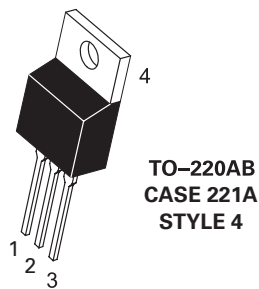

### Functional Diagram

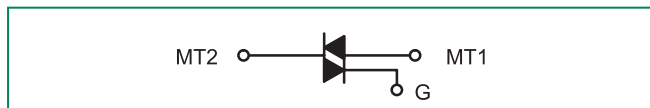

### Additional Information



**Datasheet**



**Resources**



**Samples**

### Maximum Ratings and Thermal Characteristics ( $T_J = 25^\circ\text{C}$ unless otherwise noted)

Rating		Symbol	Value	Unit
*Peak Repetitive Off-State Voltage (Note 1) ( $T_J = -40$ to $110^\circ\text{C}$ , Sine Wave, 50 to 60 Hz, Gate Open)	2N6344A, 2N6348A	$V_{\text{DRM}}$ $V_{\text{RRM}}$	600	V
	2N6349A		800	
*On-State RMS Current (Full Cycle Sine Wave 50 to 60 Hz)	( $T_C = +80^\circ\text{C}$ )	$I_{\text{T (RMS)}}$	12	A
	( $T_C = +90^\circ\text{C}$ )		6.0	
*Peak Non-Repetitive Surge Current (One Full Cycle, Sine Wave 60 Hz, $T_C = +80^\circ\text{C}$ ) Preceded and followed by rated current		$I_{\text{TSM}}$	100	A
Circuit Fusing Considerations ( $t = 8.3$ ms)		$I^2t$	59	$\text{A}^2\text{s}$
*Peak Gate Power ( $T_C = +80^\circ\text{C}$ , Pulse Width = 2 $\mu\text{s}$ )		$P_{\text{GM}}$	20	W
*Average Gate Power ( $T_C = +80^\circ\text{C}$ , $t = 8.3$ ms)		$P_{\text{G(AV)}}$	0.5	W
*Peak Gate Current ( $T_C = +80^\circ\text{C}$ , Pulse Width = 2.0 $\mu\text{s}$ )		$I_{\text{GM}}$	2.0	A
*Peak Gate Voltage ( $T_C = +80^\circ\text{C}$ , Pulse Width = 2.0 $\mu\text{s}$ )		$V_{\text{GM}}$	$\pm 10$	V
*Operating Junction Temperature Range		$T_J$	-40 to +150	$^\circ\text{C}$
*Storage Temperature Range		$T_{\text{stg}}$	-40 to +150	$^\circ\text{C}$

Stresses exceeding Maximum Ratings may damage the device. Maximum Ratings are stress ratings only. Functional operation above the Recommended Operating Conditions is not implied. Extended exposure to stresses above the Recommended Operating Conditions may affect device reliability.

\* Indicates JEDEC Registered Data.

1.  $V_{\text{DRM}}$  and  $V_{\text{RRM}}$  for all types can be applied on a continuous basis. Blocking voltages shall not be tested with a constant current source such that the voltage ratings of the devices are exceeded.

### Thermal Characteristics

Rating	Symbol	Value	Unit
* Thermal Resistance, Junction to Case	$R_{\theta\text{JC}}$	2.0	$^\circ\text{C}/\text{W}$
Maximum Lead Temperature for Soldering Purposes, 1/8" from case for 10 seconds	$T_L$	260	$^\circ\text{C}$

### Electrical Characteristics - OFF ( $T_c = 25^\circ\text{C}$ unless otherwise noted; Electricals apply in both directions)

Characteristic		Symbol	Min	Typ	Max	Unit
*Peak Repetitive Blocking Current ( $V_D = V_{DRM} = V_{RRM}$ ; Gate Open)	$T_J = 25^\circ\text{C}$	$I_{DRM}^*$	-	-	10	$\mu\text{A}$
	$T_J = 110^\circ\text{C}$	$I_{RRM}$	-	-	2.0	mA

### Electrical Characteristics - ON ( $T_c = 25^\circ\text{C}$ unless otherwise noted; Electricals apply in both directions)

Characteristic	Symbol	Min	Typ	Max	Unit
†Peak On-State Voltage ( $I_{TM} = \pm 17\text{ A Peak}$ ; Pulse Width = 1 to 2 ms, Duty Cycle $\leq 2\%$ )	$V_{TM}$	-	1.3	175	V

#### Gate Trigger Current (Continuous dc) ( $V_D = 12\text{ Vdc}$ , $R_L = 100\ \Omega$ )

Characteristic		Symbol	Min	Typ	Max	Unit
Quadrant I: MT2(+), G(+)	All	$I_{GT}$	-	6.0	50	mA
Quadrant II: MT2(+), G(-)	2N6348A & 2N6349A		-	6.0	75	
Quadrant III: MT2(-), G(-)	All		-	10	50	
Quadrant IV: MT2(-), G(+)	2N6348A & 2N6349A		-	25	75	
†MT2(+), G(+); MT2(-), G(-)	$T_c = -40^\circ\text{C}$		-	-	100	
†MT2(+), G(-); MT2(-), G(+)	$T_c = -40^\circ\text{C}$		-	-	125	

#### Gate Trigger Voltage (Continuous dc) ( $V_D = 12\text{ Vdc}$ , $R_L = 100\ \Omega$ )

Characteristic		Symbol	Min	Typ	Max	Unit
Quadrant I: MT2(+), G(+)	Both	$V_{GT}$	-	0.9	2.0	V
Quadrant II: MT2(+), G(-)	2N6349 only		-	0.9	2.5	
Quadrant III: MT2(-), G(-)	Both		-	1.1	2.0	
Quadrant IV: MT2(-), G(+)	2N6349 only		-	1.4	2.5	
†MT2(+), G(+); MT2(-), G(-) $T_c = -40^\circ\text{C}$	$T_c = -40^\circ\text{C}$		-	-	2.5	
†MT2(+), G(-); MT2(-), G(+), $T_c = -40^\circ\text{C}$	$T_c = -40^\circ\text{C}$		-	-	3.0	
Gate Non-Trigger Voltage (Continuous dc)		$V_{GD}$	.02	-	-	
†MT2(+), G(+); MT2(-), G(-); MT2(+), G(-); MT2(-), G(-)	$T_c = 25^\circ\text{C}$	$I_H$	-	6.0	40	mA
	$T_c = -40^\circ\text{C}$		-	-	75	
†Turn-On Time ( $V_D = \text{Rated } V_{DRM}$ , $I_{TM} = 11\text{ A}$ , $I_{GT} = 120\text{ mA}$ )		$t_{gt}$	-	1.5	2.0	$\mu\text{s}$

† Indicates JEDEC Registered Data.

### Dynamic Characteristics

Characteristic	Symbol	Min	Typ	Max	Unit
Critical Rate of Rise of Commutation Voltag ( $V_D = \text{Rated } V_{DRM}, I_{TM} = 17 \text{ A}$ , Commutating $di/dt = 6.1 \text{ A/ms}$ , Gate Unenergized, $T_C = 80^\circ\text{C}$ )	$dv/dt(c)$	–	5.0	–	$V/\mu\text{s}$

### Voltage Current Characteristic of Triacs (Bidirectional Device)

Symbol	Parameter
$V_{DRM}$	Peak Repetitive Forward Off State Voltage
$I_{DRM}$	Peak Forward Blocking Current
$V_{RRM}$	Peak Repetitive Reverse Off State Voltage
$I_{RRM}$	Peak Reverse Blocking Current
$V_{TM}$	Maximum On State Voltage
$I_H$	Holding Current

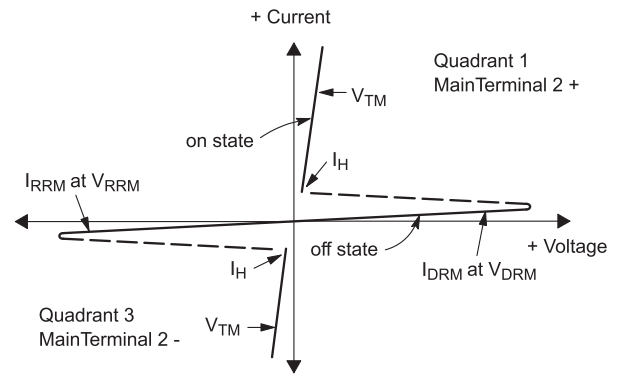

### Quadrant Definitions for a Triac

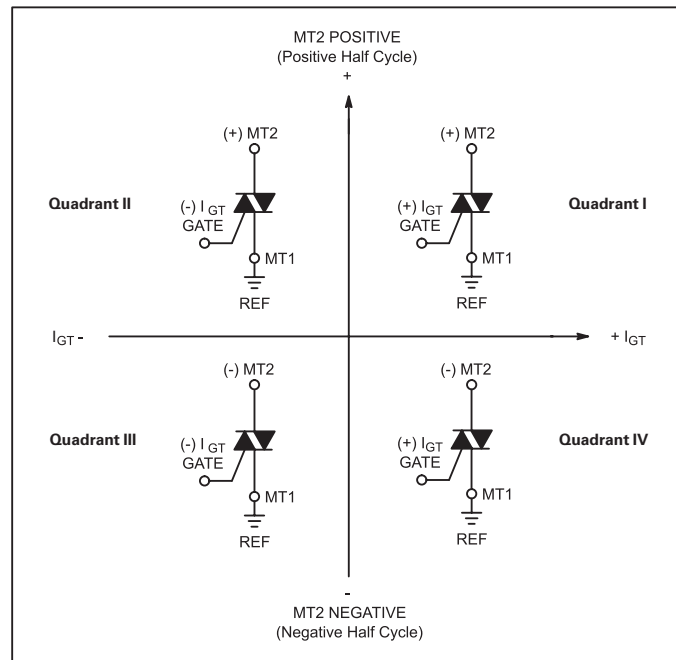

All polarities are referenced to MT1.

With in-phase signals (using standard AC lines) quadrants I and III are used.

### Ratings and Characteristic Curves

**Figure 1. RMS Current Derating**

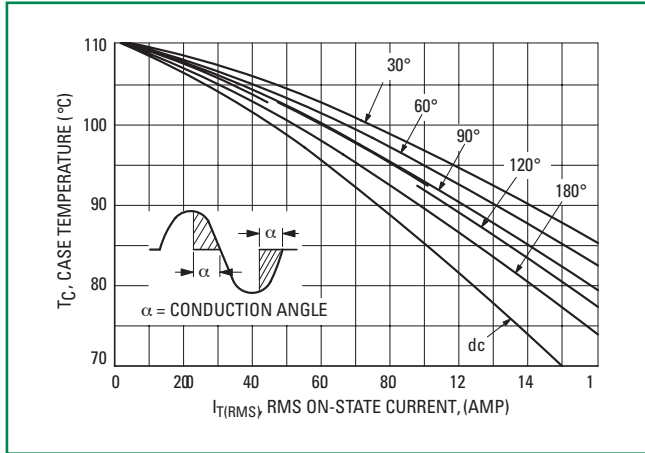

**Figure 2. On-State Power Dissipation**

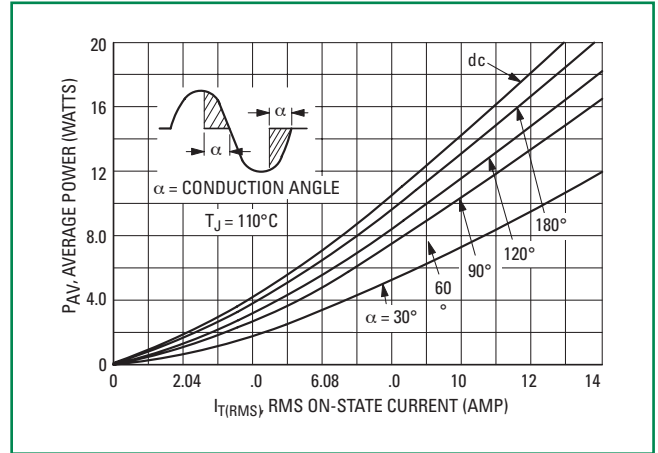

**Figure 3. Typical Gate Trigger Voltage**

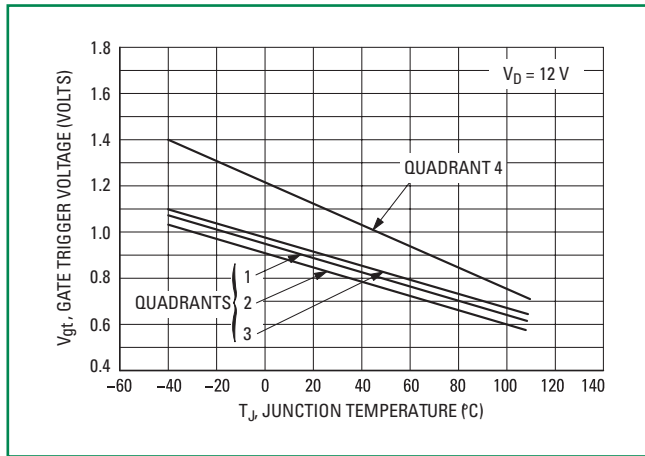

**Figure 4. Typical Gate Trigger Current**

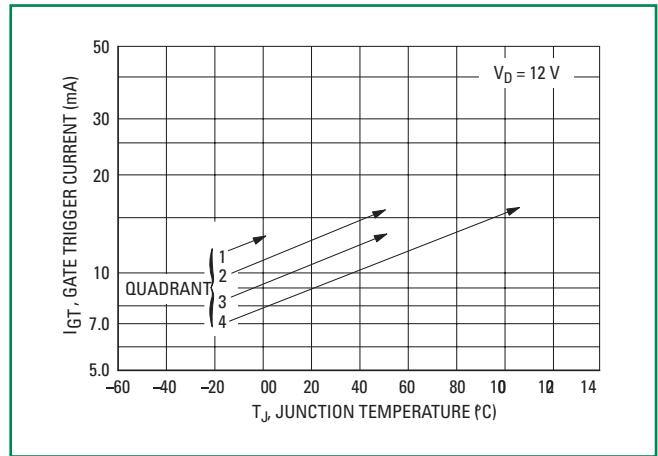

**Figure 7. Maximum On-State Characteristics**

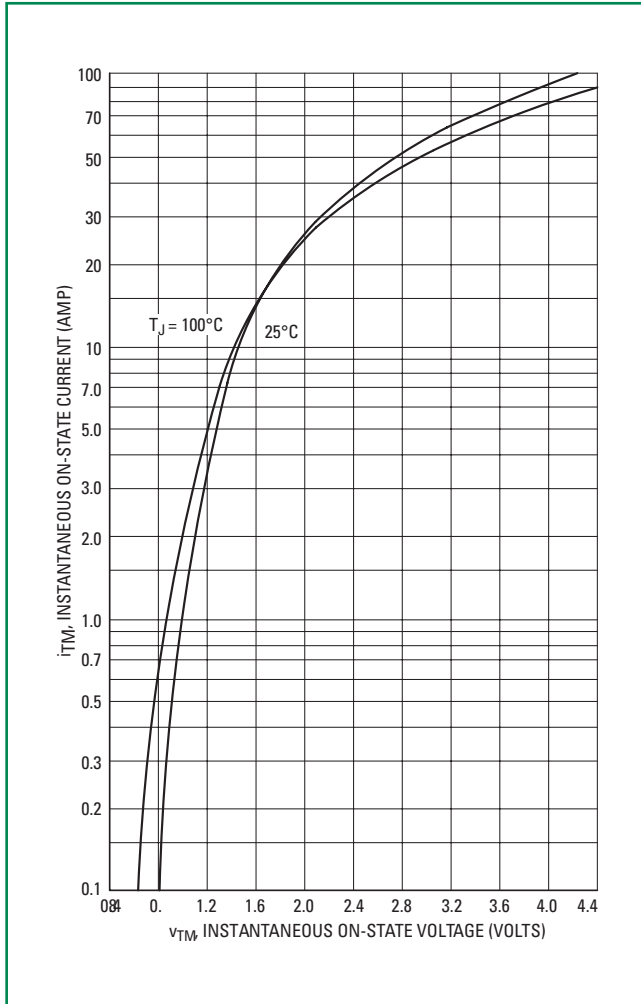

**Figure 8. Typical Holding Current**

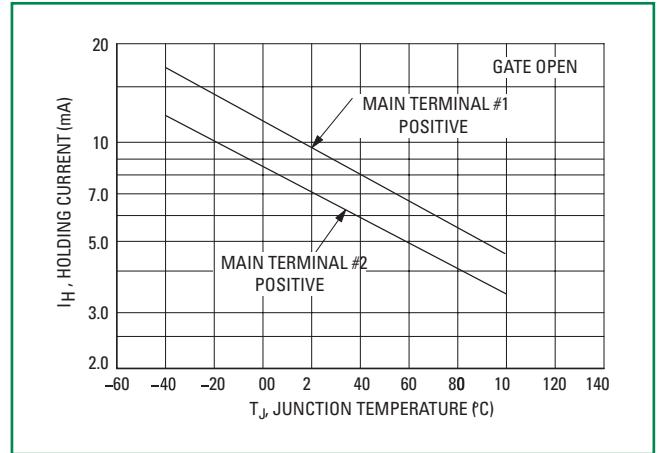

**Figure 9. Maximum Allowable Surge Current**

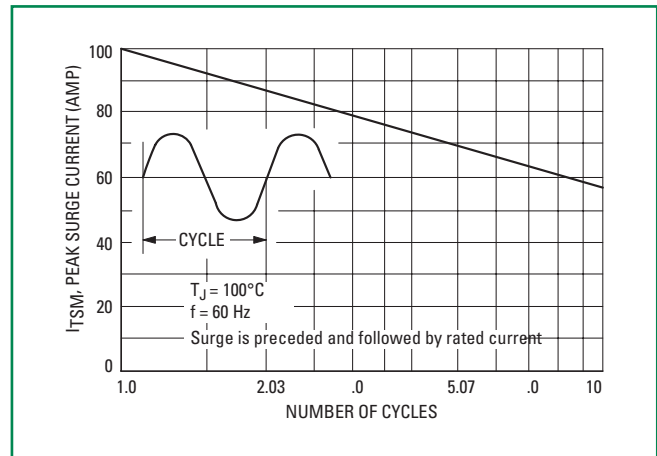

**Figure 10. Typical Thermal Response**

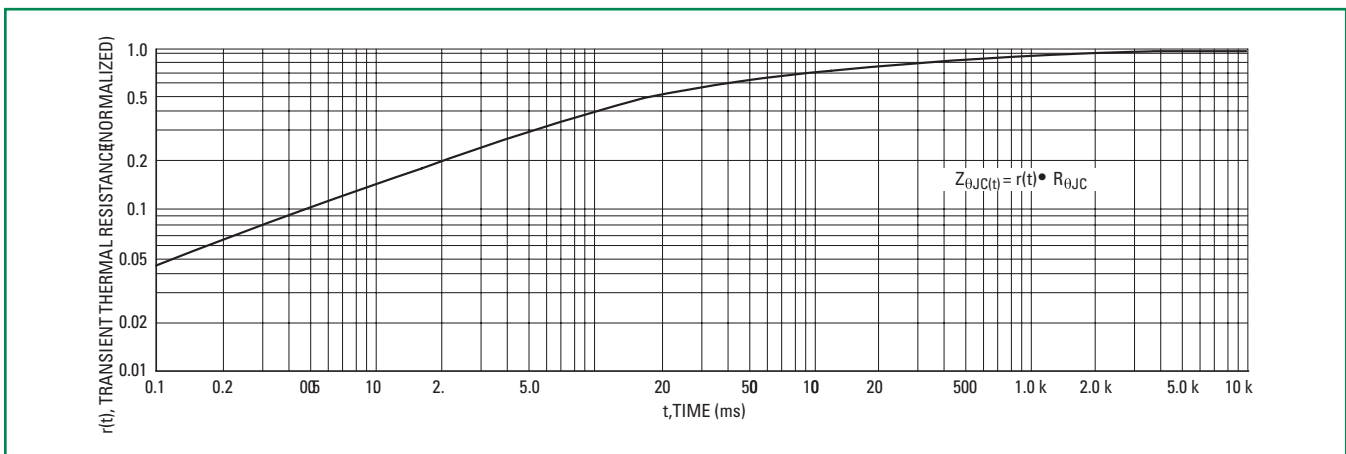

### Dimensions

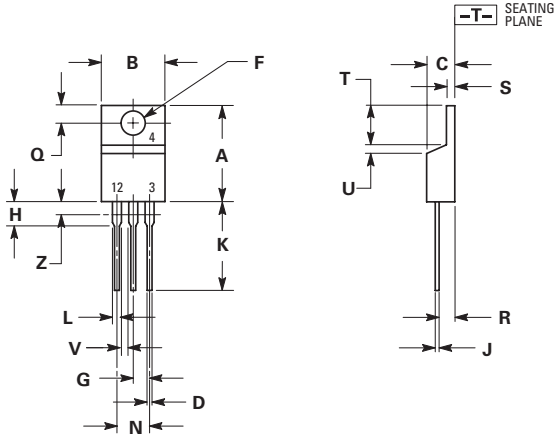

### Part Marking System

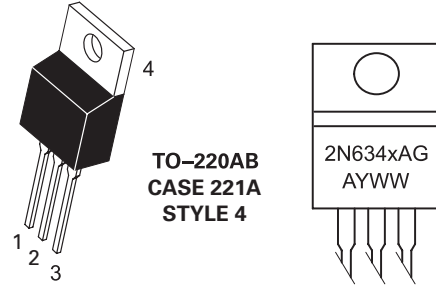

TO-220AB  
CASE 221A  
STYLE 4

2N634xA = Device Code  
x = 4, 8, or 9  
A = Assembly Location  
Y = Year  
WW = Work Week  
G = Pb-Free Package

Dim	Inches		Millimeters	
	Min	Max	Min	Max
A	0.570	0.620	14.48	15.75
B	0.380	0.405	9.66	10.28
C	0.160	0.190	4.07	4.82
D	0.025	0.035	0.64	0.88
F	0.142	0.147	3.61	3.73
G	0.095	0.105	2.42	2.66
H	0.110	0.155	2.80	3.93
J	0.014	0.022	0.36	0.55
K	0.500	0.562	12.70	14.27
L	0.045	0.060	1.15	1.52
N	0.190	0.210	4.83	5.33
Q	0.100	0.120	2.54	3.04
R	0.080	0.110	2.04	2.79
S	0.045	0.055	1.15	1.39
T	0.235	0.255	5.97	6.47
U	0.000	0.050	0.00	1.27
V	0.045	---	1.15	---
Z	---	0.080	---	2.04

1. DIMENSIONING AND TOLERANCING PER ANSI Y14.5M, 1982.
2. CONTROLLING DIMENSION: INCH.
3. DIMENSION Z DEFINES A ZONE WHERE ALL BODY AND LEAD IRREGULARITIES ARE ALLOWED.

### Pin Assignment

1	Main Terminal 1
2	Main Terminal 2
3	Gate
4	Main Terminal 2

### Ordering Information

Device	Package	Shipping†
2N6344A	TO-220AB	500 Units / Box
2N6344AG	TO-220AB (Pb-Free)	
2N6348A	TO-220AB	
2N6348AG	TO-220AB (Pb-Free)	
2N6349A	TO-220AB	
2N6349AG	TO-220AB (Pb-Free)	