



135HC3600K4VM6

Conduction Cooled (High Density Resonant)

Parts are RoHS compliant

Parts are RoHS compliant

ELECTRICAL SPECIFICATIONS

Capacitance: 1.32 μ F

AC Current: 650 A

ESR: 0.3 milliOhms at 100 kHz and 20°C

Self Inductance: 3 Nanohenries maximum

Tolerance: -10 %, +10 %

Temperature Range: -40°C to +85°C

Maximum Core Temperature: 85°C

Resonant Frequency: 100-170 kHz

Maximum power (KVAR): 300

VAC: 600 Volts AC

PHYSICAL DIMENSIONS

Length (L): 75 mm, 0.5 mm

Height (H): 50 mm, +/-0.5 mm

Thickness (B): 30.2 mm, +/-0.1 mm

LEAD STYLE: 4VM6

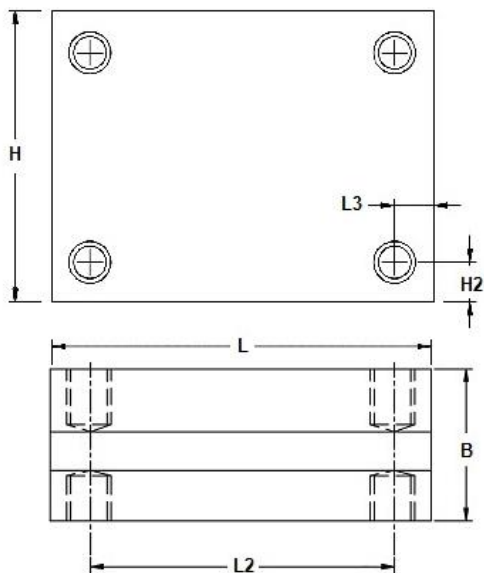

L	H	B	L2	L3	H3
75 \pm 0.5	50 \pm 0.5	30.2 \pm 0.1	65	5	5
Tightening torque: 15Nm MAX					



3757 W. Touhy Ave. Lincolnwood, IL 60712 (847) 675-1760 FAX (847) 673-2850
Illinois Capacitor (HK) Ltd., Tel: 85227930931, Fax: 85227930731, www.ilcap.com.hk
© Copyright 2017 Illinois Capacitor. A division of Cornell Dubilier, All Rights Reserved