

tolerance unless otherwise specified	
linear	.X ± .38
	.XX ± .25
	.XXX ± .13
angles	0° ± 2°

dr	Rick Bian	2010/07/03	projection 	mm ←→	size	A4	scale	0.500	
eng	Jeny Ren	2018/05/02			ecn no	ELX-DG-29895-1			
chr	-	-			rel level	Released			
appr	Nickor Zuo	2018/05/07	product family		rev	10087607		C	
Amphenol FCI			title		DDR III, 240P PRESS-FIT		dwg no		10087607
www.fci.com			cat. no.		* Product - Customer Drw		sheet		1 of 4

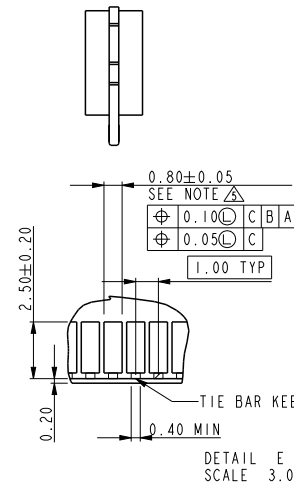

tolerance unless otherwise specified	
linear	.X ± .38
	.XX ± .25
	.XXX ± .13
angles	0° ± 2°

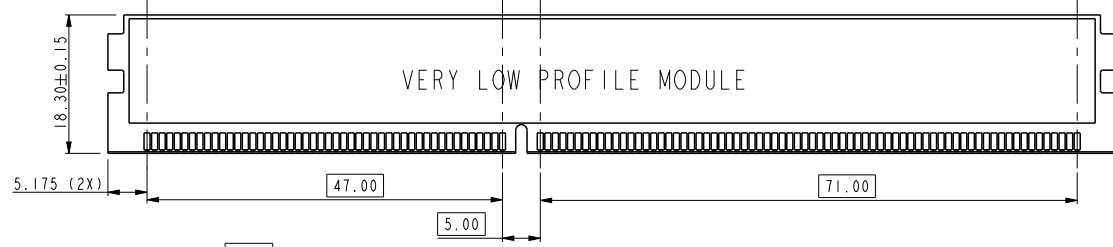
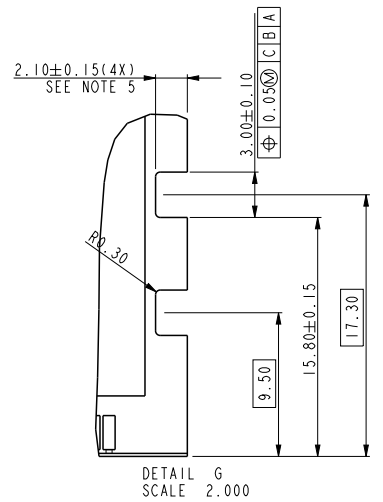
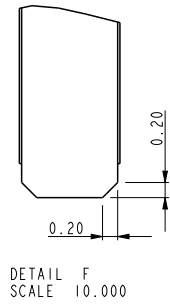
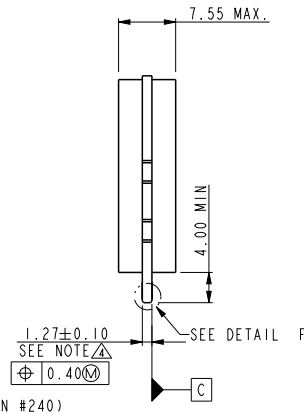
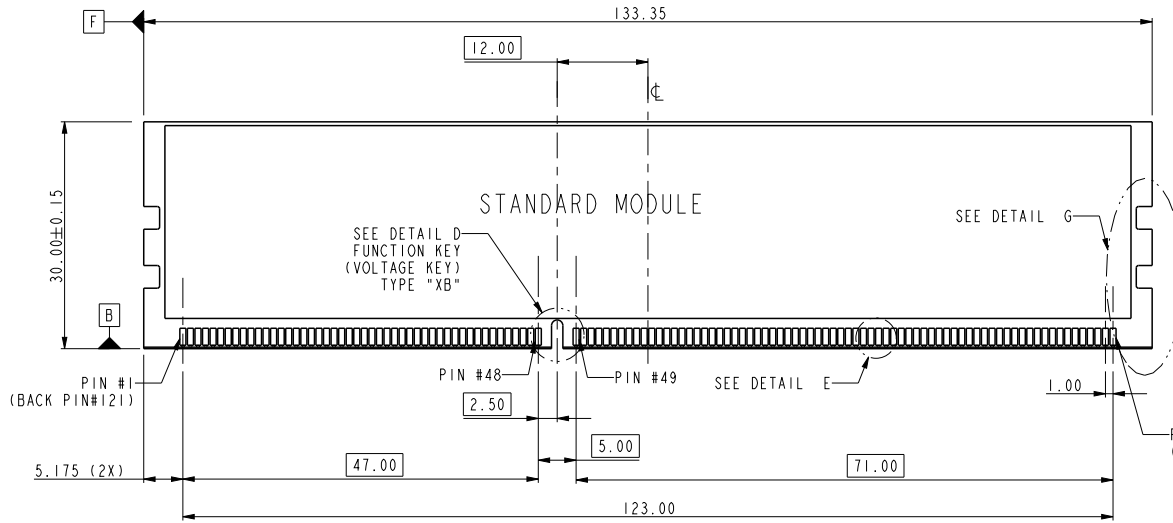
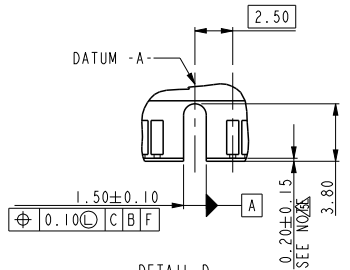

DETAIL D
FUNCTION KEY
KEY POSITION CENTER
TYPE "XB"
SCALE 2.000

NOTE:
1. MATERIAL : FR-4.
2. FINISH: SOLDER MASK.
3. BURR: 0.08 MAX.

TYPE "XB"	1.5 VOLTAGE
SUB KEY POS #1	DESCRIPTION

dr	Rick Bian	2010/07/03	projection	mm	size	A4	scale	0.500
eng	Jeny Ren	2018/05/02			ecn no ELX-DG-29895-1			
chr	-	-			rel level Released			
appr	Nickor Zuo	2018/05/07	product family		rev C			
			title		dwg no		rev	
www.fci.com			DDR III, 240P PRESS-FIT V/T HOUSING		10087607		C	
cat. no.			Product - Customer Drw		sheet 2 of 4			

A

B

C

D

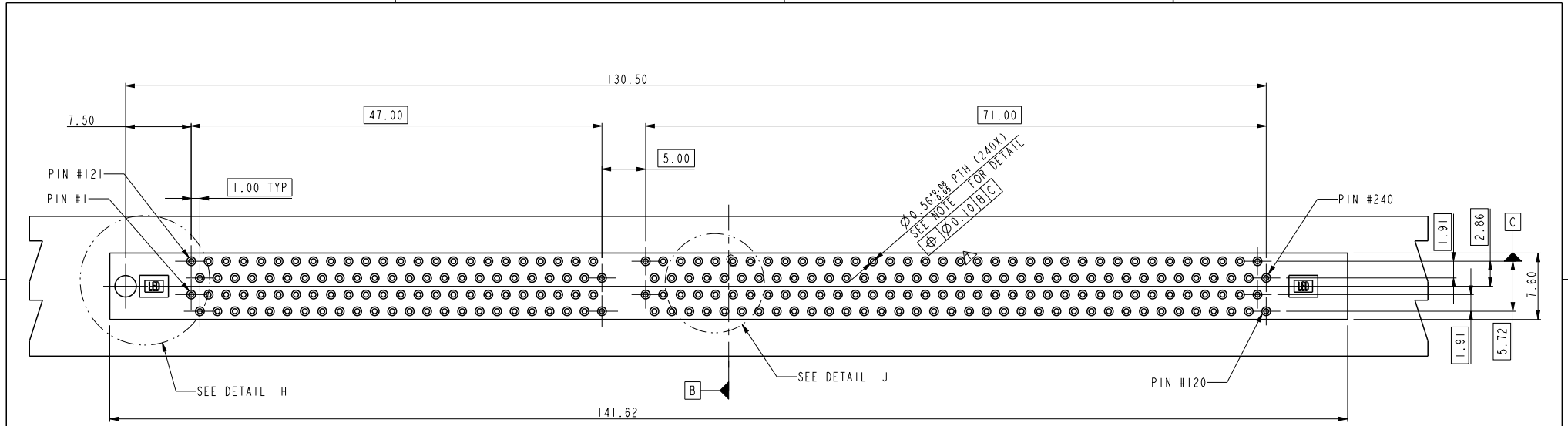

RECOMMENDED CIRCUIT BOARD HOLE PATTERN

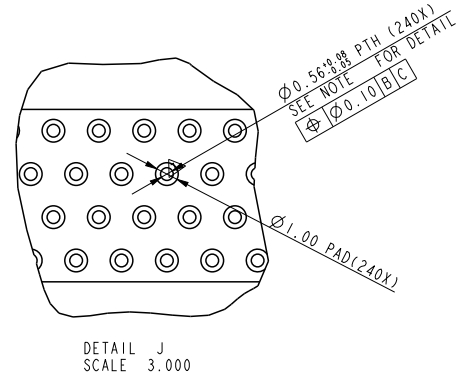
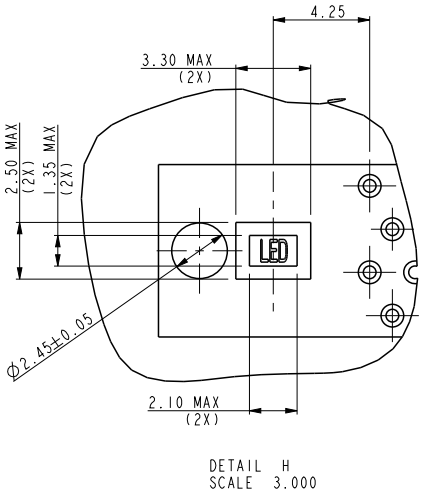

tolerance unless otherwise specified	
linear	.XX ± .38
	.XX ± .25
	.XXX ± .13
angles	0° ± 2°

dr	Rick Bian	2010/07/03	projection 	mm ←→	size	A4	scale	0.500
eng	Jeny Ren	2018/05/02			ecn no	ELX-DG-29895-1		
chr	-	-			rel level	Released		
appr	Nickor Zuo	2018/05/07	product family		rev	10087607	C	
Amphenol FCI		title			DDR III, 240P PRESS-FIT		cat. no.	
www.fci.com		V/T HOUSING			Product - Customer Drw		sheet 3 of 4	

10087607-□ □ □ □ □

STYLE: MECHANICAL KEYING

1 : 1.5 VOLT. W/CENTER KEY #1

REVISE

0

TAIL LENGTH

CODE	DIM. "D"
0	3.30
1	3.70
2	4.20

PLATING

CODE	CONTACT	TAIL AREA	UNDERPLATE	CODE	CONTACT	TAIL AREA	UNDERPLATE
2B	15u" (0.38um) MIN. GOLD	35u"~100u" Tin/Lead PLATING	50u" (1.27um) MIN. NICKEL OVERALL	2LF	15u" (0.38um) MIN. GOLD	35u"~100u" Tin PLATING	50u" (1.27um) MIN. NICKEL OVERALL
3B	30u" (0.76um) MIN. GOLD			3LF	30u" (0.76um) MIN. GOLD		
4B	3u" (0.076um) MIN. GOLD			4LF	3u" (0.076um) MIN. GOLD		
6B	15u" (0.38um) MIN. GOLD (LUBRICATED)	35u"~100u" Tin/Lead PLATING	50u" (1.27um) MIN. NICKEL OVERALL	6LF	15u" (0.38um) MIN. GOLD (lubricated)	35u"~100i" Tin PLATING	50u" (1.27um) MIN. NICKEL OVERALL
7B	30u" (0.76um) MIN. GOLD (LUBRICATED)			7LF	30u" (0.76um) MIN. GOLD (LUBRICATED)		
8B	3u" (0.076um) MIN. GOLD (LUBRICATED)			8LF	3u" (0.076um) MIN. GOLD (LUBRICATED)		

NOTE:

- MATERIAL:
HOUSING: HIGH PERFORMANCE RESINS, GLASS FILLED UL94V-0 RATED, COLOR: BLACK.
EJECTOR: HIGH PERFORMANCE RESINS, GLASS FILLED UL94V-0 RATED, COLOR: NATURAL.
TERMINAL: COPPER ALLOY.
 - FCI LOGO TO BE APPROXIMATELY LOCATED AS SHOWN ON PRINT.
 - PRODUCT SPECIFICATION: GS-12-XXX(SPECIFICATION NOT YET AVAILABLE)
 - CARD THICKNESS APPLIES ACROSS TABS AND INCLUDES PLATING AND / OR METALIZATION.
 - LEADING EDGE OF CONTACT PADS SPECIFIED BY THE KEEP OUT ZONE SHALL BE FREE OF BURRS AND EXTERNAL TIE BARS.
FOR OPTIMUM PERFORMANCE, THE TIE BAR IS TO BE ON AN INTERNAL LAYER SO THAT THE REMNANT CANNOT CAUSE CONTACT DAMAGE.
 - PACKAGING SPECIFICATION: GS-14-528.
 - ALL PTH SHOULD BE 0.66mm DIA DRILLED AND 0.025mm MIN. ELECTRO-DEPOSITED COPPER THK ON THROUGH HOLE WALL.
 - THIS PRODUCT MEETS EUROPEAN UNION DIRECTIVES AND OTHER COUNTRY REGULATIONS AS DESCRIBED IN GS-22-008.
 - THE HOUSING WILL WITHSTAND EXPOSURE TO 260°C PEAK TEMPERATURE FOR 10 SECONDS IN A WAVE SOLDER APPLICATION.
 - THE AMBER EJECTOR CAN WITHSTAND MAX 174°C EXPOSURE TEMPERATURE
- DATE CODE: X X X X X X

COLOR OF HOUSING AN EJECTOR

- 0 : BLACK HOUSING + IVORY EJECTOR
- 1 : BLACK HOUSING + AMBER COLOR EJECTOR
- 2 : BLACK HOUSING + BLACK EJECTOR
- 3 : IVORY HOUSING + IVORY EJECTOR
- 4 : BLUE HOUSING + IVORY EJECTOR

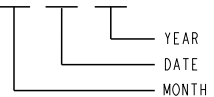

dr	Rick Bian	2010/07/03	projection 	mm 	size	A4	scale	0.500	
eng	Jeny Ren	2018/05/02			ecn no	ELX-DG-29895-1			
chr	-	-			rel level	Released			
appr	Nickor Zuo	2018/05/07	product family	dwg no		10087607		rev	C
Amphenol FCI		title			DDR III, 240P PRESS-FIT			V/T HOUSING	
www.fci.com		cat. no.	*	Product - Customer Drw			sheet 4 of 4		