







313/315 Series Lead-Free 3AG, Slo-Blo® Fuse



Agency Approvals

Agency	Agency File Number	Ampere Range
	E 10480	0.010A - 10A**
	29862	0.010A - 10A**/15A**
	E 10480	10A - 30A
	313 Series (Cartridge): NBK040205-E10480B NBK040205-E10480D	1-5A 6.25- 10A**
	315 Series (Leaded): NBK040205-E10480F NBK040205-EO1480H NBK280906-JP1021	1-5A 6.25-10A** 15**
	SU05001-6004 SU05001-5007 SU05001-5008 SU05001-5009	2.25-2.5A 2.8A - 3.2A 4A - 6.3A 7A-8A
	N/A	0.010A - 10A**/15A**

** See note under Electrical Characteristics by item

Additional Information



**Datasheet
313 Series**



**Resources
313 Series**



**Samples
313 Series**



**Datasheet
315 Series**



**Resources
315 Series**



**Samples
315 Series**



**Accessories
313 & 315 Series**

For recommended fuse accessories for this product series, see '[Recommended Accessories](#)' section.

Description

The 3AG Slo-Blo® fuse solves a broad range of application requirements while offering reliable performance and cost-effective circuit protection.

The fuse catalog number with the suffix "ID" instantly identifies itself upon opening by showing a discoloration of its glass body. Guesswork and time consuming circuit testing are eliminated. This unique design offers the same quality performance characteristics as the standard 3AG Slo-Blo® Fuse design.

Features

- In accordance with UL Standard 248-14
- Available in cartridge and axial lead format and with various forming dimensions
- RoHS compliant and Lead-free

Applications

Used as supplementary protection in appliance or utilization equipment to provide individual protection for components or internal circuits.

Electrical Characteristics by Series

% of Ampere Rating	Ampere Rating	Opening Time
100%	10mA – 30A	4 hours, Minimum
135%	10mA – 30A	1 hour, Maximum
200%	10mA – 15A	5 sec., Min., 30 sec., Max
	20A – 30A	5 sec., Min., 60 sec Max

Electrical Characteristic Specifications by Item

Amp Code	Ampere Rating (A)	Voltage Rating (V)	Interrupting Rating	Nominal Cold Resistance (Ohms)	Nominal Melting I ² t (A ² sec)	Agency Approvals					
						UL	SF	CCC	RU	PS E	CE
.010	0.01	250	35A@250Vac 10KA@125Vac	4300.0000	0.000121	x	x				x
.031	0.031	250		430.0000	0.00303	x	x				x
.040	0.04	250		300.0000	0.00630	x	x				x
.062	0.062	250		120.0000	0.0210	x	x				x
.100	0.1	250		43.0000	0.0850	x	x				x
.125	0.125	250		30.0000	0.152	x	x				x
.150	0.15	250		20.0000	0.270	x	x				x
.175	0.175	250		8.6700	0.177	x	x				x
.187	0.187	250		8.0100	0.230	x	x				x
.200	0.2	250		6.5900	0.270	x	x				x
.250	0.25	250		4.2700	0.385	x	x				x
.300	0.3	250		3.1350	0.730	x	x				x
.375	0.375	250		2.0950	1.23	x	x				x
.400	0.4	250		1.8750	1.35	x	x				x
.500*	0.5	250		1.2600	2.55	x	x				x
.600	0.6	250		0.9120	4.00	x	x				x
.700	0.7	250		0.7000	5.90	x	x				x
.750	0.75	250		0.6215	7.16	x	x				x
.800	0.8	250		0.5540	8.00	x	x				x
001.*	1	250		0.3750	14.0	x	x			x	x
01.2	1.2	250	0.2780	21.5	x	x			x	x	
1.25	1.25	250	0.2600	24.0	x	x			x	x	
01.5*	1.5	250	0.1910	38.0	x	x			x	x	
01.6	1.6	250	0.1710	49.6	x	x			x	x	
01.8	1.8	250	0.1410	92.0	x	x			x	x	
002.*	2	250	0.1169	77.0	x	x			x	x	
2.25	2.25	250	0.0968	121	x	x	x		x	x	
02.5	2.5	250	0.0811	199	x	x	x		x	x	
02.8	2.8	250	0.0675	269	x	x	x		x	x	
003.*	3	250	0.0593	200	x	x	x		x	x	
03.2	3.2	250	0.0529	209	x	x	x		x	x	
004.*	4	250	0.0311	76.1	x	x	x		x	x	
005.*	5	250	0.0214	276	x	x	x		x	x	
6.25*	6.25	250	0.0154	388	x	x	x		x	x	
06.3	6.3	250	0.0154	388	x	x	x		x	x	
007.*	7	250	0.0128	547	x	x	x		x	x	
008.*	8	250	0.0111	701	x	x	x		x	x	
010.**	10	250	0.0083	1285	x	x			x	x	
010.*	10	32	0.0083	1285				x			
012.	12	32	0.0065	1200				x			
015.**	15	125	0.0050	2650		x		x	x	x	
015.	15	32	0.0050	2650				x			
020.	20	32	0.0022	9560				x			
025.	25	32	0.0017	16500				x			
030.	30	32	0.0012	26900				x			
			300A@32Vac								

* For 313series, these ratings available with an indicating option. Add the "ID" designation to the series number. i.e. 313.500ID.

** These 2 ratings are designed for special voltage requirement. For 10A, it is available as 250Vac rated and the part number is 0313010.MX250P; For 15A, it is available as 125Vac rated and the part number is 0315015.MX125P.

Temperature Re-rating Curve

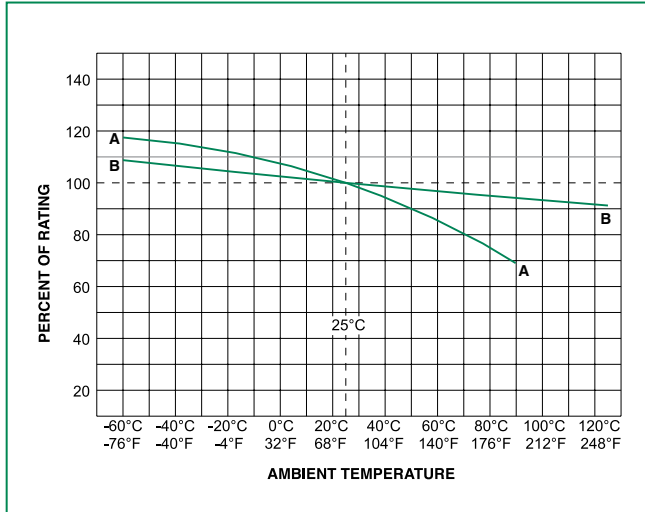

A - For 313/315 Series, from 10mA to 150mA

B - For all other ampere ratings of 313/315 series

Note:

Derating depicted in this curve is in addition to the standard derating of 25% for continuous operation.

Average Time Current Curves

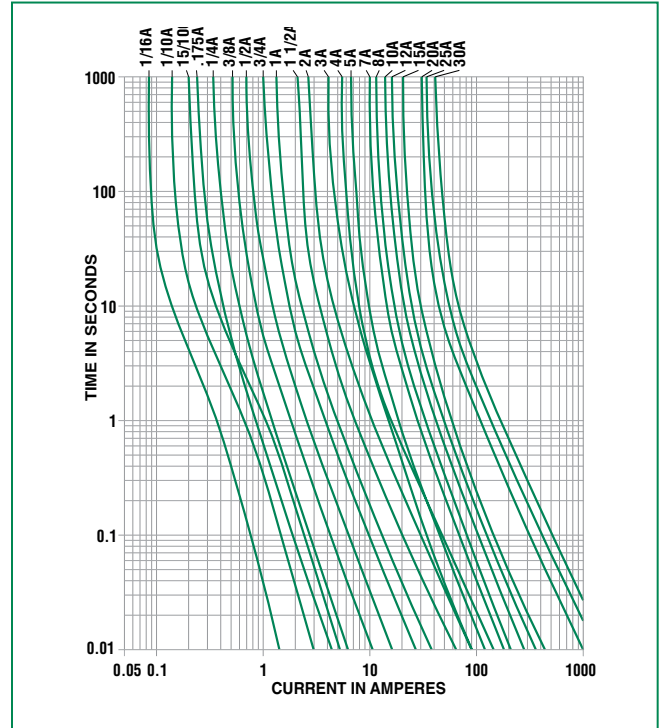

Soldering Parameters - Wave Soldering

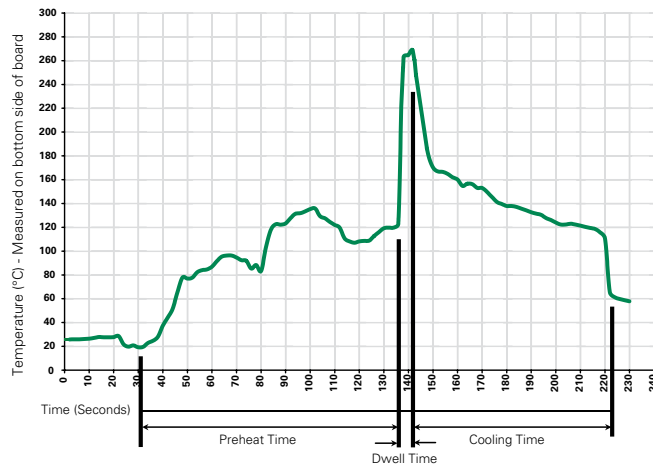

Recommended Process Parameters:

Wave Parameter	Lead-Free Recommendation
Preheat: (Depends on Flux Activation Temperature) (Typical Industry Recommendation)	
Temperature Minimum:	100°C
Temperature Maximum:	150°C
Preheat Time:	60-180 seconds
Solder Pot Temperature:	260°C Maximum
Solder Dwell Time:	2-5 seconds

Recommended Hand-Solder Parameters:

Solder Iron Temperature: 350°C +/- 5°C
 Heating Time: 5 seconds max.

Note: These devices are not recommended for IR or Convection Reflow process.

Packaging

Packaging Option	Packaging Specification	Quantity	Quantity & Packaging Code	Taping Width
313 Series				
Bulk	N/A	1000	MX	N/A
Bulk	N/A	100	HX	N/A
315 Series				
Bulk	N/A	1000	MX	N/A
Bulk	N/A	100	HX	N/A
Bulk	N/A	1000	MXB	N/A

Product Characteristics

Materials	Body: Glass Cap: Nickel-plated brass Leads: Tin-plated Copper
Terminal Strength	MIL-STD-202, Method 211, Test Condition A
Solderability	MIL-STD-202 method 208
Product Marking	Cap1: Brand logo, current and voltage ratings Cap2: Series and agency approval marks

Operating Temperature	-55°C to +125°C
Thermal Shock	MIL-STD-202, Method 107, Test Condition B: (5 cycles -65°C to +125°C)
Vibration	MIL-STD-202, Method 201
Humidity	MIL-STD-202, Method 103, Test Condition A: High RH (95%) and Elevated temperature (40°C) for 240 hours
Salt Spray	MIL-STD-202, Method 101, Test Condition B

Dimensions

Measurements displayed in millimeters (inches)

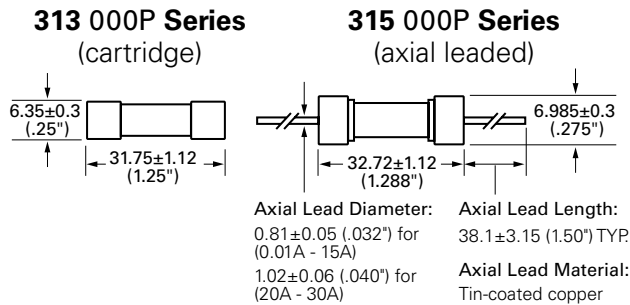

Part Numbering System

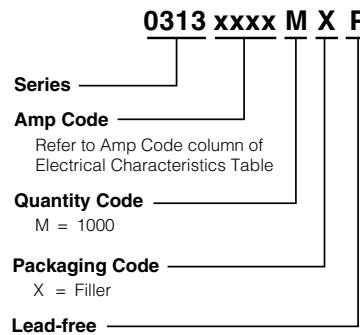

Recommended Accessories

Accessory Type	Series	Description	Max Application Voltage	Max Application Amperage
Holder	155100	Twist-Lock In-Line Fuseholder	32	20
	342	Traditional Panel Mount Fuseholder	250	20
	346	Panel Mount Flip-Top Shock-Safe Fuseholder	250	15
	345	Shock-Safe Fuseholder with PC Mount, Solder Mount and Panel Mount options	250	16
Block	354	Low Profile OMNI-BLOK® Fuse Block	600	30
	359	High Current Screw Terminal Fuse Block		30
Clip	122	High Current Traditional PC Board Fuse Clip	1000	30
	101	Rivet/Eyelet Type Fuse Clip	1000	15

Notes:
 1. Do not use in applications above rating.
 2. Please refer to fuseholder data sheet for specific re-rating information.
 3. Please contact factory for applications greater than the max voltage and amperage shown.

Disclaimer Notice - Information furnished is believed to be accurate and reliable. However, users should independently evaluate the suitability of and test each product selected for their own applications. Littelfuse products are not designed for, and may not be used in, all applications. Read complete Disclaimer Notice at www.littelfuse.com/disclaimer-electronics.