

216SP Series, 5x20 mm, Fast-Acting Fuse



Description

5x20mm fast-acting ceramic body cartridge fuse Designed to IEC specification









Features

- Designed to International (IEC) Standards for use globally
- High breaking capacity
- Meets the IEC 60127-2, Sheet 1 specification for Fast-Acting fuses
- RoHS compliant and lead-free

Applications

Used as supplementary protection in appliance or utilization equipment to provide individual protection for components or internal circuits.



Agency Approvals

Agency		Ampere Range
	NBK080205-E10480B NBK250702-E10480F	1A – 5A 6.3A – 10A
	CQC10012049970	1A – 10A
	SU05001-11001A SU05001-11002A	1A – 2.5A 3.15A – 6.3A
	E10480	1A – 10A
	29862	1A – 10A
	40013834	1 – 6.3A
	J50248090	8A/10A
	N/A	1A – 10A

Electrical Characteristics for Series

% of Ampere Rating	Ampere Rating	Opening Time
210%	1A – 4A	30 minutes, Maximum
	5A – 6.3A	30 minutes, Maximum
	8A – 10A	30 minutes, Maximum
275%	1A – 4A	0.01 sec., Min.; 2 sec. Max.
	5A – 6.3A	0.01 sec., Min.; 3 sec. Max.
	8A – 10A	0.04 sec., Min.; 20 sec. Max.
400%	1A – 4A	.003 sec., Min.; 0.3 sec. Max.
	5A – 6.3A	.003 sec., Min.; 0.3 sec. Max.
	8A – 10A	.01 sec., Min.; 1.0 sec. Max.
1000%	1A – 4A	.02 seconds, Maximum
	5A – 6.3A	.02 seconds, Maximum
	8A – 10A	.03 sec.onds, Maximum

Electrical Characteristic Specifications by Item

Amp Code	Amp Rating	Voltage Rating	Interrupting Rating	Nominal Resistance Cold Ohms (Ohms)	Nominal Melting I ² t (A ² sec)	Maximum Voltage Drop at Rated Current (mV)	Maximum Power Dissipation at 1.5I _n (W)	Agency Approvals									
																	
001.	1	250	1500 A @ 250 VAC	0.2370	0.18000	1000	2.5	x	x	x	x	x	x	x	x	x	
01.6	1.6	250		0.1112	1.00500	600	4	x	x	x	x	x	x	x	x	x	x
002.	2	250		0.0764	1.87000	500	4	x	x	x	x	x	x	x	x	x	x
02.5	2.5	250		0.0584	3.67200	400	4	x	x	x	x	x	x	x	x	x	x
3.15	3.15	250		0.0368	6.70000	350	4	x	x	x	x	x	x	x	x	x	x
004.	4	250		0.0247	14.99500	300	4	x	x	x	x	x	x	x	x	x	x
005.	5	250		0.0183	27.46000	250	4	x	x	x	x	x	x	x	x	x	x
06.3	6.3	250		0.0137	56.43000	200	4	x	x	x	x	x	x	x	x	x	x
008.	8	250		0.0123	64.31500	200	4	x	x	x	x	x	x	x	x	x	x
010.	10	250		0.0079	154.34000	200	4	x	x	x	x	x	x	x	x	x	x

I²t test at 10x rated current

Temperature Re-rating Curve

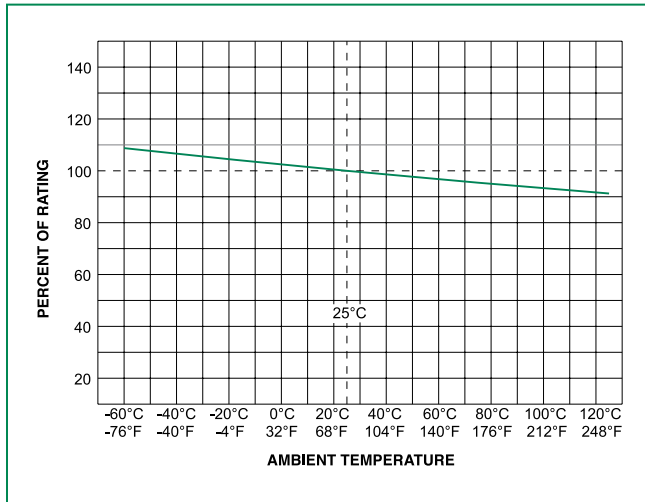

Average Time Current Curves

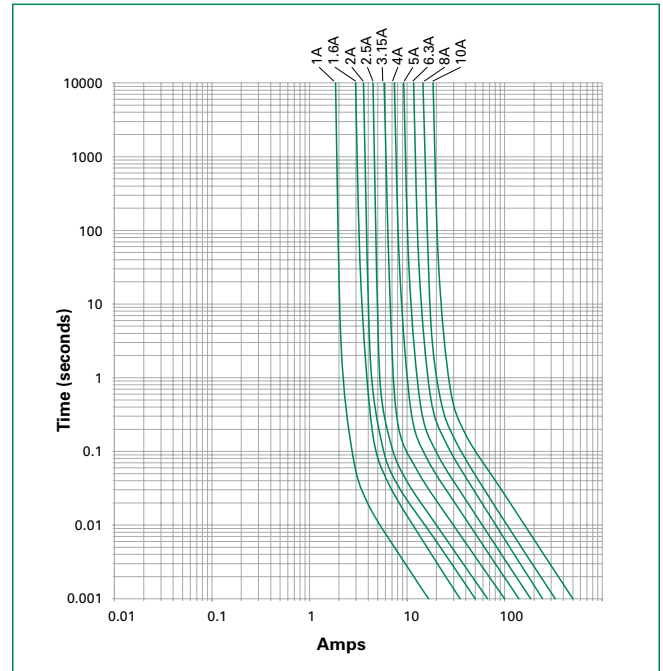

Soldering Parameters - Wave Soldering

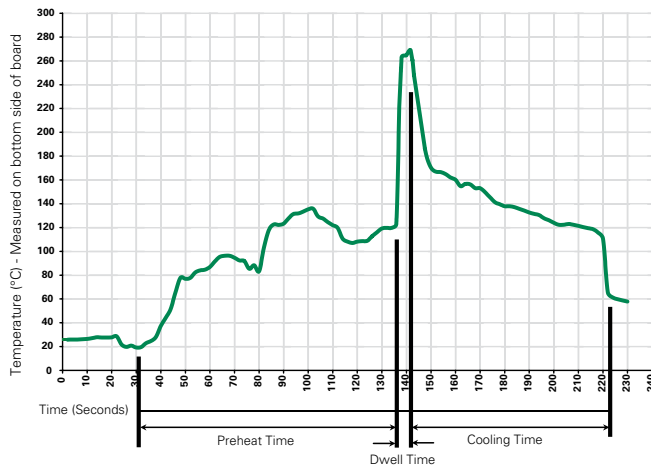

Recommended Process Parameters:

Wave Parameter	Lead-Free Recommendation
Preheat: (Depends on Flux Activation Temperature) (Typical Industry Recommendation)	
Temperature Minimum:	100°C
Temperature Maximum:	150°C
Preheat Time:	60-180 seconds
Solder Pot Temperature:	260°C Maximum
Solder Dwell Time:	2-5 seconds

Recommended Hand-Solder Parameters:

Solder Iron Temperature: 350°C +/- 5°C
Heating Time: 5 seconds max.

Note: These devices are not recommended for IR or Convection Reflow process.

Different values of A and B available, please contact the Littelfuse sales representative in your region:

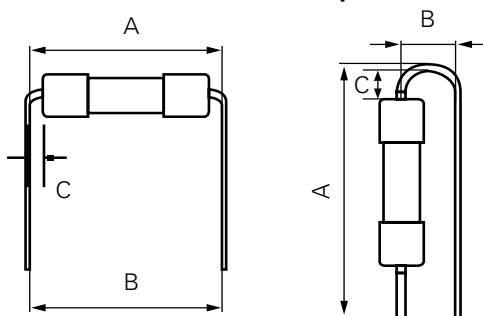

For the pigtailed fuse, please follow the recommendations below for axial lead forming and mounting into PCB:

Lead forming:

The distance C between cap flat surface and axial lead shall be greater than 1.0 mm.

PCB mounting:

According to the standard of IPC-A-610, the distance between PCB and fuse cap is recommended to be a minimum of 1.5 mm.

Product Characteristics

Materials	Body: Ceramic Cap: Nickel-plated Brass Leads: Tin-plated Copper
Terminal Strength	MIL-STD-202, Method 211, Test Condition A
Solderability	MIL-STD-202 Method 208
Product Marking	Cap 1: Brand logo, current and voltage ratings Cap 2: Agency approval marks

Operating Temperature	-55°C to +125°C
Thermal Shock	MIL-STD-202, Method 107, Test Condition B (5 cycles, -65°C to +125°C)
Vibration	MIL-STD-202, Method 201
Humidity	MIL-STD-202, Method 103, Test Condition A (High RH (95%) and elevated temp (40°C) for 240 hours)
Salt Spray	MIL-STD-202, Method 101, Test Condition B

Dimensions

All dimensions in mm

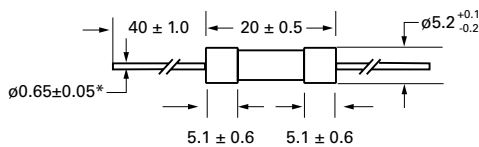

Notes:

* Ratings 8A and 10A have 0.8 ± 0.05 diameter lead.

Part Numbering System

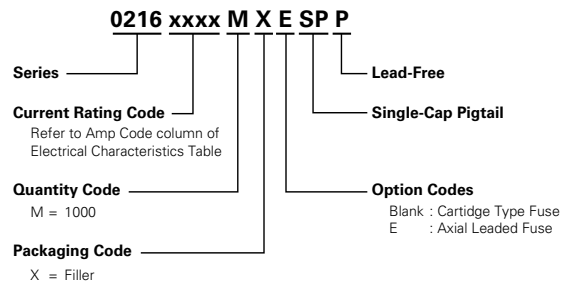

Packaging

Packaging Option	Packaging Specification	Quantity	Packaging Code	Reel Size
216SP Series				
Bulk	N/A	1000	MXE	N/A

Additional Information



Datasheet



Resources



Samples

Disclaimer Notice - Information furnished is believed to be accurate and reliable. However, users should independently evaluate the suitability of and test each product selected for their own applications. Littelfuse products are not designed for, and may not be used in, all applications. Read complete Disclaimer Notice at www.littelfuse.com/disclaimer-electronics.