

Cree® XLamp® XP-E High-Efficiency White LEDs



PRODUCT DESCRIPTION

XLamp® XP-E High-Efficiency White (HEW) LEDs upgrade the XLamp XP-E LED to leading performance levels for diffuse lighting applications. The XP-E HEW is designed to enable faster adoption of LED light in cost-sensitive, consumer lighting products. Compared to the standard XLamp XP-E LED, the XP-E HEW can reduce LED count by 50% and still deliver the same system performance.

Cree XLamp LEDs bring high performance and quality of light to a wide range of lighting applications, including color-changing, portable and personal, outdoor, indoor-directional, transportation, stage and studio, commercial and emergency-vehicle lighting.

FEATURES

- Light output and efficacy similar to XLamp XP-G LED
- Maximum drive current: 1000 mA
- Low thermal resistance: 6 °C/W
- Maximum junction temperature: 150 °C
- Wide viewing angle: 120°
- Reflow solderable - JEDEC J-STD-020C compatible
- Electrically neutral thermal path
- RoHS and REACH compliant
- UL® recognized component (E349212)

TABLE OF CONTENTS

Characteristics	2
Flux Characteristics	3
Relative Spectral Power Distribution ...	5
Relative Flux vs. Junction Temperature	6
Electrical Characteristics	6
Relative Flux vs. Current	7
Relative Chromaticity vs. Current	7
Relative Chromaticity vs. Temperature	8
Typical Spatial Distribution	8
Thermal Design	9
Performance Groups - Luminous Flux	9
Performance Groups - Chromaticity ..	10
Performance Groups - Forward Voltage	12
Cree's Standard Chromaticity Regions Plotted on the 1931 CIE Curve	13
Cree's Standard Cool White Kits Plotted on ANSI Standard Chromaticity Regions	14
Cree's Standard Warm and Neutral White Kits Plotted on ANSI Standard Chromaticity Regions	15
Cree's Standard Chromaticity Kits	16
Bin and Order Code Formats	16
Reflow Soldering Characteristics	17
Notes	18
Mechanical Dimensions	20
Tape and Reel	21
Packaging	22



CHARACTERISTICS

Characteristics	Unit	Minimum	Typical	Maximum
Thermal resistance, junction to solder point - white	°C/W		6	
Viewing angle (FWHM) - white	degrees		120	
Temperature coefficient of voltage - white	mV/°C		-3	
ESD classification (HBM per Mil-Std-883D)			Class 2	
DC forward current - white	mA			1000
Reverse voltage	V			5
Forward voltage (@ 350 mA) - white	V		3.0	3.5
Forward voltage (@ 700 mA) - white	V		3.15	
Forward voltage (@ 1000 mA) - white	V		3.25	
LED junction temperature	°C			150

FLUX CHARACTERISTICS ($T_j = 25\text{ }^\circ\text{C}$)

The following tables provide order codes for XLamp XP-E HEW LEDs. For a complete description of the order code nomenclature, please see the Bin and Order Code Formats section (page 16). For definitions of the chromaticity kits, please see the Cree's Standard Chromaticity Kits section (page 16).

Chromaticity		Minimum Luminous Flux (lm) @ 350 mA		Order Codes
Kit	CCT	Code	Flux (lm)	68 CRI Typical
51	6200 K	R5	139	XPEHEW-L1-0000-00H51
		R4	130	XPEHEW-L1-0000-00G51
		R3	122	XPEHEW-L1-0000-00F51
53	6000 K	R5	139	XPEHEW-L1-0000-00H53
		R4	130	XPEHEW-L1-0000-00G53
		R3	122	XPEHEW-L1-0000-00F53
50	6200 K	R3	122	XPEHEW-L1-0000-00F50

Chromaticity		Minimum Luminous Flux (lm) @ 350 mA		Order Codes		
Kit	CCT	Code	Flux (lm)	70 CRI Typical	75 CRI Typical	80 CRI Minimum
E3	5000 K	R4	130	XPEHEW-01-0000-00GE3		
		R3	122	XPEHEW-01-0000-00FE3	XPEHEW-L1-0000-00FE3	
		R2	114	XPEHEW-01-0000-00EE3	XPEHEW-L1-0000-00EE3	
		Q5	107		XPEHEW-L1-0000-00DE3	
F4	4750 K	R4	130	XPEHEW-01-0000-00GF4		
		R3	122	XPEHEW-01-0000-00FF4	XPEHEW-L1-0000-00FF4	
		R2	114	XPEHEW-01-0000-00EF4	XPEHEW-L1-0000-00EF4	
		Q5	107		XPEHEW-L1-0000-00DF4	
E4	4500 K	R4	130	XPEHEW-01-0000-00GE4		
		R3	122	XPEHEW-01-0000-00FE4	XPEHEW-L1-0000-00FE4	
		R2	114	XPEHEW-01-0000-00EE4	XPEHEW-L1-0000-00EE4	
		Q5	107		XPEHEW-L1-0000-00DE4	
F5	4250 K	R4	130	XPEHEW-01-0000-00GF5		
		R3	122	XPEHEW-01-0000-00FF5	XPEHEW-L1-0000-00FF5	
		R2	114	XPEHEW-01-0000-00EF5	XPEHEW-L1-0000-00EF5	
		Q5	107		XPEHEW-L1-0000-00DF5	
E5	4000 K	R4	130	XPEHEW-01-0000-00GE5		
		R3	122	XPEHEW-01-0000-00FE5	XPEHEW-L1-0000-00FE5	
		R2	114	XPEHEW-01-0000-00EE5	XPEHEW-L1-0000-00EE5	XPEHEW-H1-0000-00EE5
		Q5	107		XPEHEW-L1-0000-00DE5	XPEHEW-H1-0000-00DE5

Notes:

- Cree maintains a tolerance of $\pm 7\%$ on flux and power measurements, ± 0.005 on chromaticity (CCx, CCy) measurements and a tolerance of ± 2 on CRI measurements. See the Measurements section (page 18).
- Cree XLamp XP-E HEW LED order codes specify only a minimum flux bin and not a maximum. Cree may ship reels in flux bins higher than the minimum specified by the order code without advance notice. Shipments will always adhere to the chromaticity bin restrictions specified by the order code.

FLUX CHARACTERISTICS (T_j = 25 °C) - CONTINUED

Chromaticity		Minimum Luminous Flux (lm) @ 350 mA		Order Codes				
Kit	CCT	Code	Flux (lm)	70 CRI Typical	80 CRI Typical	80 CRI Minimum	85 CRI Minimum	90 CRI Minimum
F6	3750 K	R2	114	XPEHEW-01-0000-00EF6	XPEHEW-L1-0000-00EF6	XPEHEW-H1-0000-00EF6		
		Q5	107	XPEHEW-01-0000-00DF6	XPEHEW-L1-0000-00DF6	XPEHEW-H1-0000-00DF6		
		Q4	100		XPEHEW-L1-0000-00CF6	XPEHEW-H1-0000-00CF6		
E6	3500 K	R2	114	XPEHEW-01-0000-00EE6	XPEHEW-L1-0000-00EE6			
		Q5	107	XPEHEW-01-0000-00DE6	XPEHEW-L1-0000-00DE6	XPEHEW-H1-0000-00DE6		
		Q4	100		XPEHEW-L1-0000-00CE6	XPEHEW-H1-0000-00CE6		
F7	3250 K	R2	114	XPEHEW-01-0000-00EF7				
		Q5	107	XPEHEW-01-0000-00DF7	XPEHEW-L1-0000-00DF7	XPEHEW-H1-0000-00DF7		
		Q4	100	XPEHEW-01-0000-00CF7	XPEHEW-L1-0000-00CF7	XPEHEW-H1-0000-00CF7		
		Q3	93.9		XPEHEW-L1-0000-00BF7	XPEHEW-H1-0000-00BF7		
		P3	73.9					
E7	3000 K	R2	114	XPEHEW-01-0000-00EE7				
		Q5	107	XPEHEW-01-0000-00DE7	XPEHEW-L1-0000-00DE7			
		Q4	100	XPEHEW-01-0000-00CE7	XPEHEW-L1-0000-00CE7	XPEHEW-H1-0000-00CE7		
		Q3	93.9		XPEHEW-L1-0000-00BE7	XPEHEW-H1-0000-00BE7	XPEHEW-P1-0000-00BE7	
		Q2	87.4				XPEHEW-P1-0000-00AE7	XPEHEW-U1-0000-00AE7
		P4	80.6				XPEHEW-P1-0000-009E7	XPEHEW-U1-0000-009E7
F8	2850 K	Q5	107	XPEHEW-01-0000-00DF8				
		Q4	100	XPEHEW-01-0000-00CF8	XPEHEW-L1-0000-00CF8	XPEHEW-H1-0000-00CF8		
		Q3	93.9		XPEHEW-L1-0000-00BF8	XPEHEW-H1-0000-00BF8		
		Q2	87.4		XPEHEW-L1-0000-00AF8	XPEHEW-H1-0000-00AF8	XPEHEW-P1-0000-00AF8	XPEHEW-U1-0000-00AF8
		P4	80.6				XPEHEW-P1-0000-009F8	XPEHEW-U1-0000-009F8
		P3	73.9				XPEHEW-P1-0000-008F8	XPEHEW-U1-0000-008F8
E8	2700 K	Q5	107	XPEHEW-01-0000-00DE8				
		Q4	100	XPEHEW-01-0000-00CE8	XPEHEW-L1-0000-00CE8			
		Q3	93.9		XPEHEW-L1-0000-00BE8	XPEHEW-H1-0000-00BE8		
		Q2	87.4		XPEHEW-L1-0000-00AE8	XPEHEW-H1-0000-00AE8	XPEHEW-P1-0000-00AE8	
		P4	80.6				XPEHEW-P1-0000-009E8	XPEHEW-U1-0000-009E8
		P3	73.9				XPEHEW-P1-0000-008E8	XPEHEW-U1-0000-008E8

Notes:

- Cree maintains a tolerance of ±7% on flux and power measurements, ±0.005 on chromaticity (CCx, CCy) measurements and a tolerance of ±2 on CRI measurements. See the Measurements section (page 18).
- Cree XLamp XP-E HEW LED order codes specify only a minimum flux bin and not a maximum. Cree may ship reels in flux bins higher than the minimum specified by the order code without advance notice. Shipments will always adhere to the chromaticity bin restrictions specified by the order code.

RELATIVE SPECTRAL POWER DISTRIBUTION

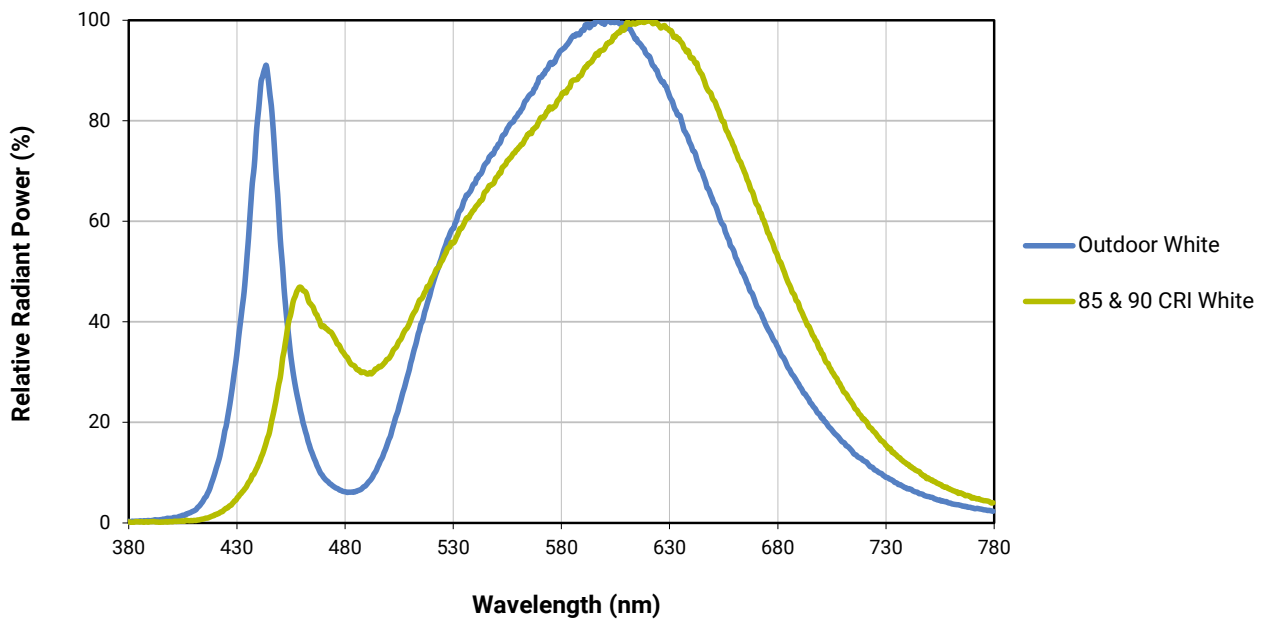
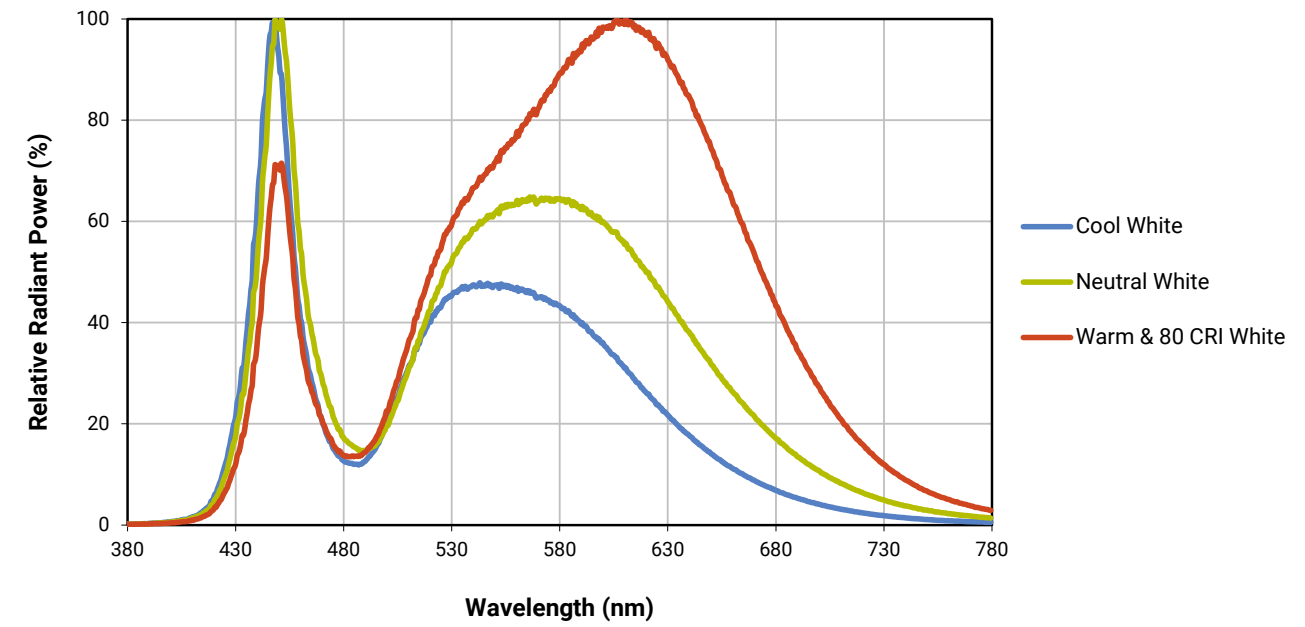

RELATIVE FLUX VS. JUNCTION TEMPERATURE ($I_F = 350 \text{ mA}$)

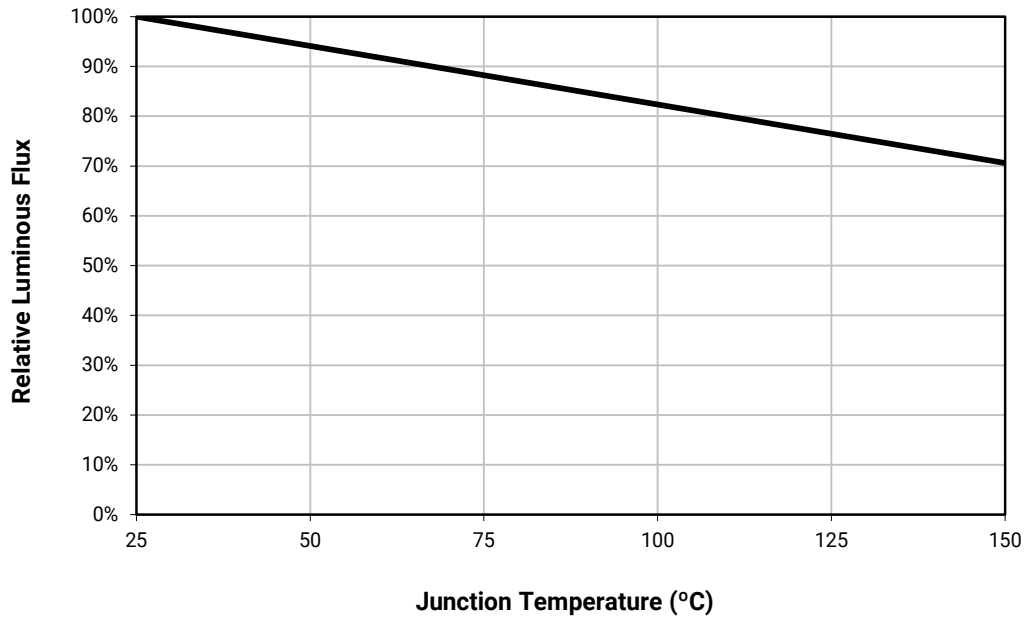

ELECTRICAL CHARACTERISTICS ($T_J = 25 \text{ °C}$)

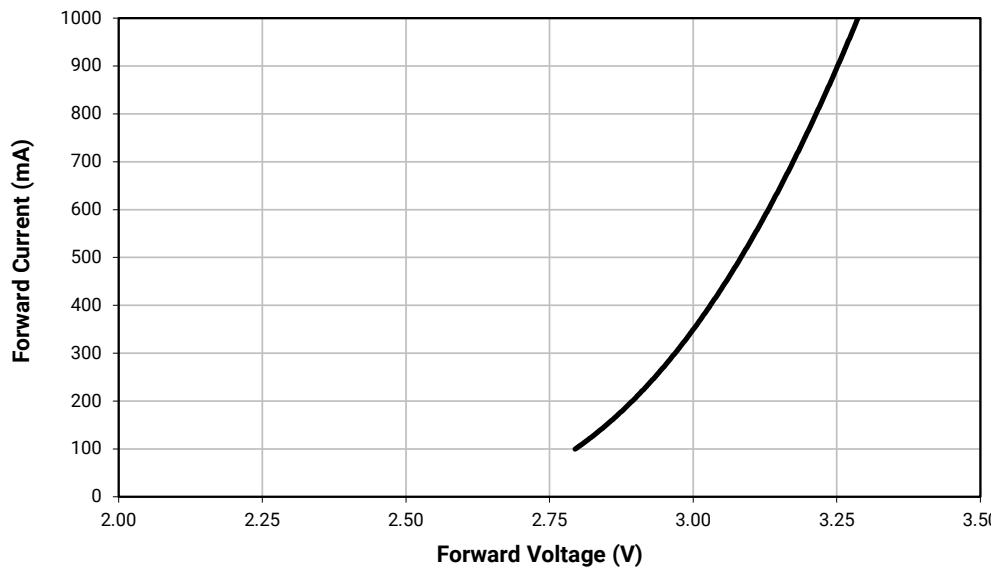

RELATIVE FLUX VS. CURRENT ($T_j = 25\text{ }^\circ\text{C}$)

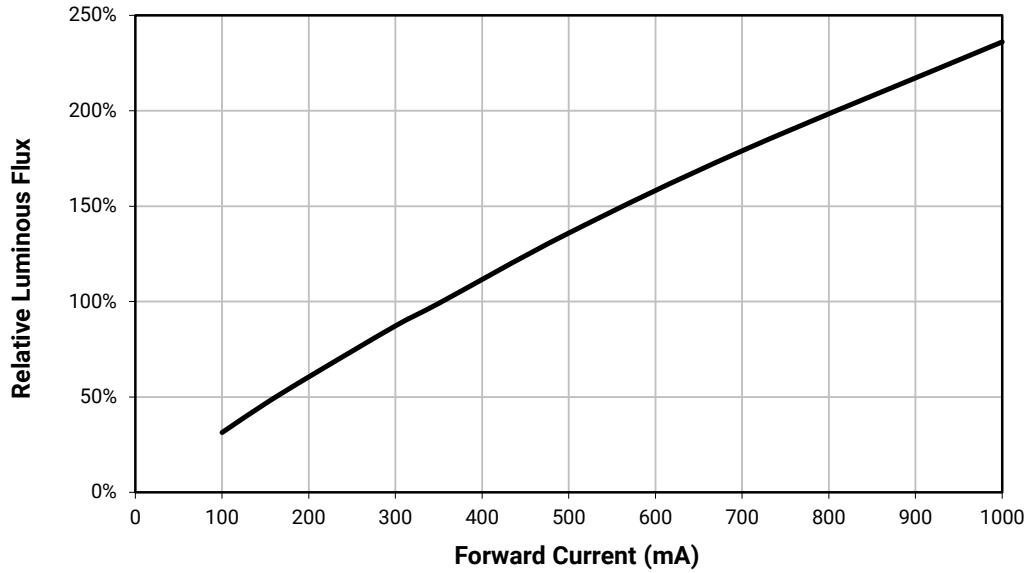

RELATIVE CHROMATICITY VS. CURRENT - WARM WHITE

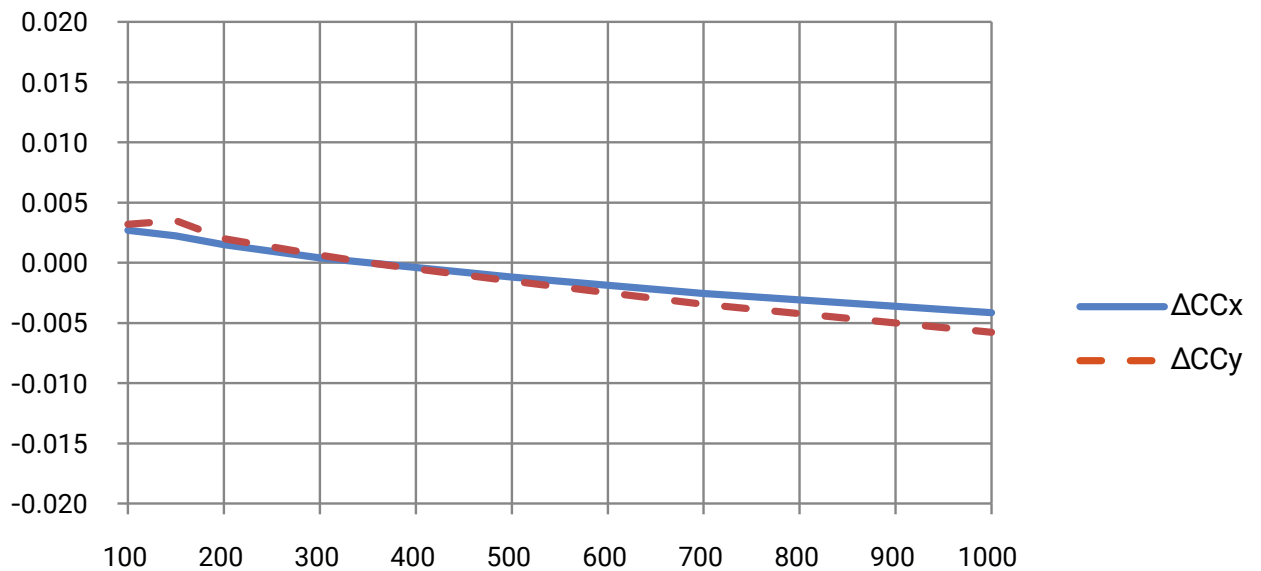

RELATIVE CHROMATICITY VS. TEMPERATURE - WARM WHITE

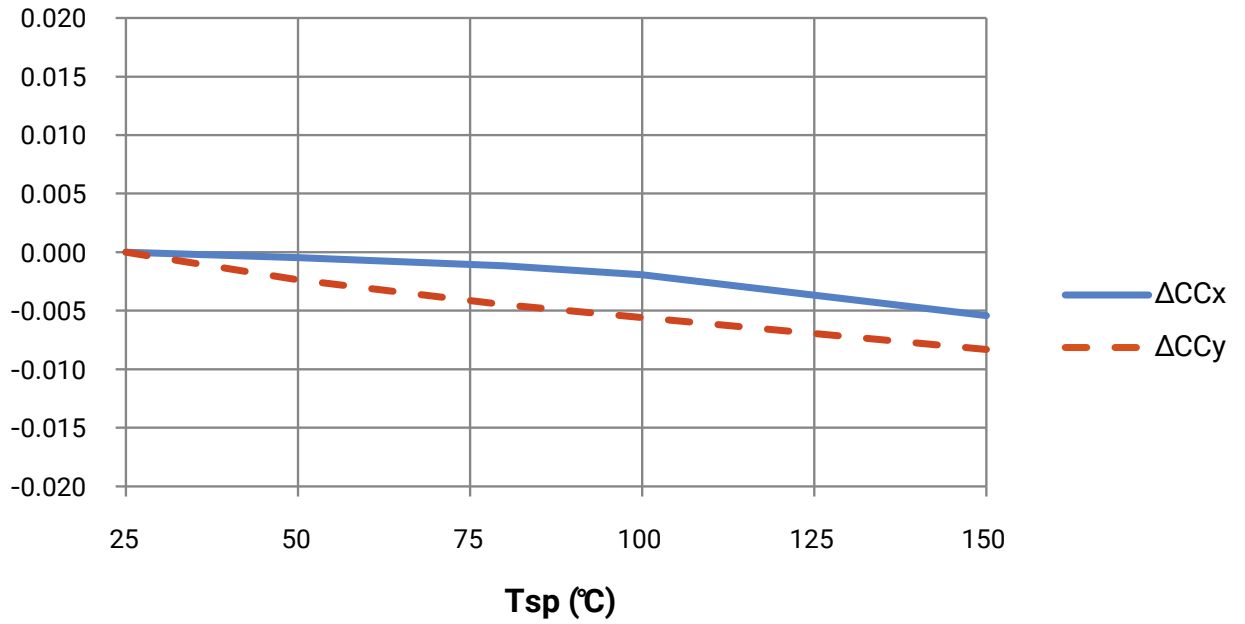

TYPICAL SPATIAL DISTRIBUTION

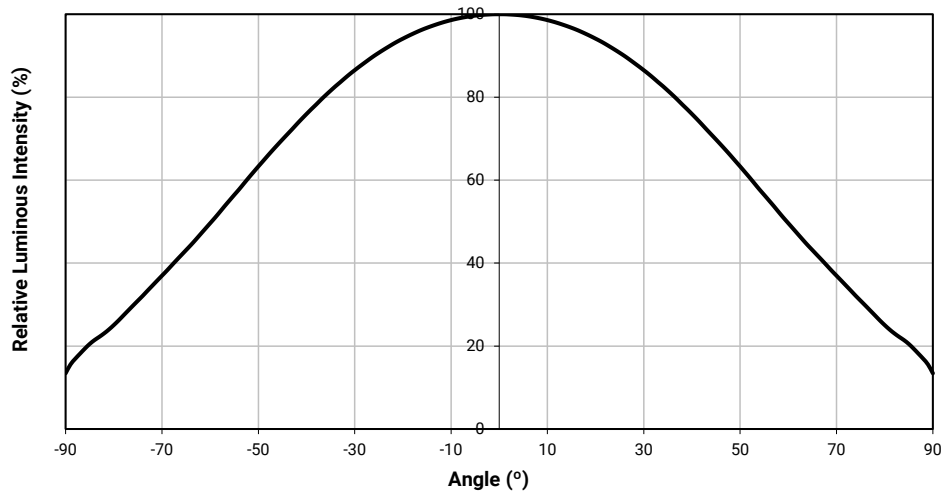

THERMAL DESIGN

The maximum forward current is determined by the thermal resistance between the LED junction and ambient. It is crucial for the end product to be designed in a manner that minimizes the thermal resistance from the solder point to ambient in order to optimize lamp life and optical characteristics.

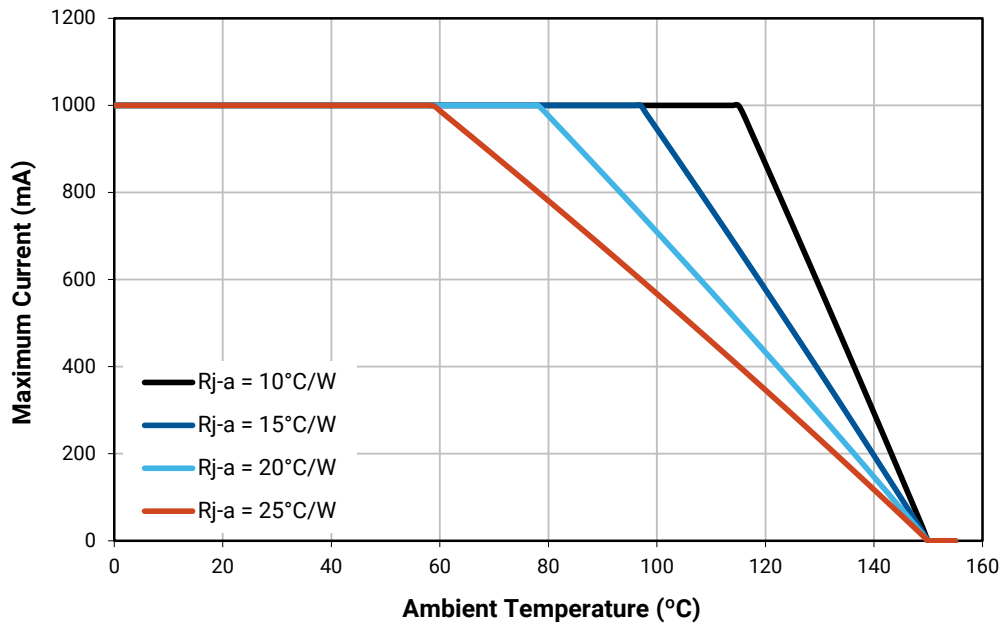

PERFORMANCE GROUPS - LUMINOUS FLUX

XLamp XP-E HEW LEDs are tested for luminous flux and placed into one of the following luminous-flux groups:

Group Code	Minimum Luminous Flux (lm) @ 350 mA	Maximum Luminous Flux (lm) @ 350 mA
P3	73.9	80.6
P4	80.6	87.4
Q2	87.4	93.9
Q3	93.9	100
Q4	100	107
Q5	107	114
R2	114	122
R3	122	130
R4	130	139
R5	139	148
S2	148	156
S3	156	164
S4	164	172

PERFORMANCE GROUPS - CHROMATICITY

White XLamp LEDs are tested for chromaticity and placed into one of the regions defined by the bounding coordinates on the following pages.

Region	x	y	Region	x	y	Region	x	y	Region	x	y
0A	0.2950	0.2970	0B	0.2920	0.3060	0C	0.2984	0.3133	0D	0.2984	0.3133
	0.2920	0.3060		0.2895	0.3135		0.2962	0.3220		0.3048	0.3207
	0.2984	0.3133		0.2962	0.3220		0.3028	0.3304		0.3068	0.3113
	0.3009	0.3042		0.2984	0.3133		0.3048	0.3207		0.3009	0.3042
0R	0.2980	0.2880	0S	0.2895	0.3135	0T	0.2962	0.3220	0U	0.3037	0.2937
	0.2950	0.2970		0.2870	0.3210		0.2937	0.3312		0.3009	0.3042
	0.3009	0.3042		0.2937	0.3312		0.3005	0.3415		0.3068	0.3113
	0.3037	0.2937		0.2962	0.3220		0.3028	0.3304		0.3093	0.2993
1A	0.3048	0.3207	1B	0.3028	0.3304	1C	0.3115	0.3391	1D	0.3130	0.3290
	0.3130	0.3290		0.3115	0.3391		0.3205	0.3481		0.3213	0.3373
	0.3144	0.3186		0.3130	0.3290		0.3213	0.3373		0.3221	0.3261
	0.3068	0.3113		0.3048	0.3207		0.3130	0.3290		0.3144	0.3186
1R	0.3068	0.3113	1S	0.3005	0.3415	1T	0.3099	0.3509	1U	0.3144	0.3186
	0.3144	0.3186		0.3099	0.3509		0.3196	0.3602		0.3221	0.3261
	0.3161	0.3059		0.3115	0.3391		0.3205	0.3481		0.3231	0.3120
	0.3093	0.2993		0.3028	0.3304		0.3115	0.3391		0.3161	0.3059
2A	0.3215	0.3350	2B	0.3207	0.3462	2C	0.3290	0.3538	2D	0.3290	0.3417
	0.3290	0.3417		0.3290	0.3538		0.3376	0.3616		0.3371	0.3490
	0.3290	0.3300		0.3290	0.3417		0.3371	0.3490		0.3366	0.3369
	0.3222	0.3243		0.3215	0.3350		0.3290	0.3417		0.3290	0.3300
2R	0.3222	0.3243	2S	0.3196	0.3602	2T	0.3290	0.3690	2U	0.3290	0.3300
	0.3290	0.3300		0.3290	0.3690		0.3381	0.3762		0.3366	0.3369
	0.3290	0.3180		0.3290	0.3538		0.3376	0.3616		0.3361	0.3245
	0.3231	0.3120		0.3207	0.3462		0.3290	0.3538		0.3290	0.3180
3A	0.3371	0.3490	3B	0.3376	0.3616	3C	0.3463	0.3687	3D	0.3451	0.3554
	0.3451	0.3554		0.3463	0.3687		0.3551	0.3760		0.3533	0.3620
	0.3440	0.3427		0.3451	0.3554		0.3533	0.3620		0.3515	0.3487
	0.3366	0.3369		0.3371	0.3490		0.3451	0.3554		0.3440	0.3427
3R	0.3366	0.3369	3S	0.3381	0.3762						
	0.3440	0.3428		0.3480	0.3840						
	0.3429	0.3307		0.3463	0.3687						
	0.3361	0.3245		0.3376	0.3616						
4A	0.3530	0.3597	4B	0.3548	0.3736	4C	0.3641	0.3804	4D	0.3615	0.3659
	0.3615	0.3659		0.3641	0.3804		0.3736	0.3874		0.3702	0.3722
	0.3590	0.3521		0.3615	0.3659		0.3702	0.3722		0.3670	0.3578
	0.3512	0.3465		0.3530	0.3597		0.3615	0.3659		0.3590	0.3521

PERFORMANCE GROUPS - CHROMATICITY (CONTINUED)

Region	x	y	Region	x	y	Region	x	y	Region	x	y
5A1	0.3670	0.3578	5A2	0.3686	0.3649	5A3	0.3744	0.3685	5A4	0.3726	0.3612
	0.3686	0.3649		0.3702	0.3722		0.3763	0.3760		0.3744	0.3685
	0.3744	0.3685		0.3763	0.3760		0.3825	0.3798		0.3804	0.3721
	0.3726	0.3612		0.3744	0.3685		0.3804	0.3721		0.3783	0.3646
5B1	0.3702	0.3722	5B2	0.3719	0.3797	5B3	0.3782	0.3837	5B4	0.3763	0.3760
	0.3719	0.3797		0.3736	0.3874		0.3802	0.3916		0.3782	0.3837
	0.3782	0.3837		0.3802	0.3916		0.3869	0.3958		0.3847	0.3877
	0.3763	0.3760		0.3782	0.3837		0.3847	0.3877		0.3825	0.3798
5C1	0.3825	0.3798	5C2	0.3847	0.3877	5C3	0.3912	0.3917	5C4	0.3887	0.3836
	0.3847	0.3877		0.3869	0.3958		0.3937	0.4001		0.3912	0.3917
	0.3912	0.3917		0.3937	0.4001		0.4006	0.4044		0.3978	0.3958
	0.3887	0.3836		0.3912	0.3917		0.3978	0.3958		0.3950	0.3875
5D1	0.3783	0.3646	5D2	0.3804	0.3721	5D3	0.3863	0.3758	5D4	0.3840	0.3681
	0.3804	0.3721		0.3825	0.3798		0.3887	0.3836		0.3863	0.3758
	0.3863	0.3758		0.3887	0.3836		0.3950	0.3875		0.3924	0.3794
	0.3840	0.3681		0.3863	0.3758		0.3924	0.3794		0.3898	0.3716
6A1	0.3889	0.3690	6A2	0.3915	0.3768	6A3	0.3981	0.3800	6A4	0.3953	0.3720
	0.3915	0.3768		0.3941	0.3848		0.4010	0.3882		0.3981	0.3800
	0.3981	0.3800		0.4010	0.3882		0.4080	0.3916		0.4048	0.3832
	0.3953	0.3720		0.3981	0.3800		0.4048	0.3832		0.4017	0.3751
6B1	0.3941	0.3848	6B2	0.3968	0.3930	6B3	0.4040	0.3966	6B4	0.4010	0.3882
	0.3968	0.3930		0.3996	0.4015		0.4071	0.4052		0.4040	0.3966
	0.4040	0.3966		0.4071	0.4052		0.4146	0.4089		0.4113	0.4001
	0.4010	0.3882		0.4040	0.3966		0.4113	0.4001		0.4080	0.3916
6C1	0.4080	0.3916	6C2	0.4113	0.4001	6C3	0.4186	0.4037	6C4	0.4150	0.3950
	0.4113	0.4001		0.4146	0.4089		0.4222	0.4127		0.4186	0.4037
	0.4186	0.4037		0.4222	0.4127		0.4299	0.4165		0.4259	0.4073
	0.4150	0.3950		0.4186	0.4037		0.4259	0.4073		0.4221	0.3984
6D1	0.4017	0.3751	6D2	0.4048	0.3832	6D3	0.4116	0.3865	6D4	0.4082	0.3782
	0.4048	0.3832		0.4080	0.3916		0.4150	0.3950		0.4116	0.3865
	0.4116	0.3865		0.4150	0.3950		0.4221	0.3984		0.4183	0.3898
	0.4082	0.3782		0.4116	0.3865		0.4183	0.3898		0.4147	0.3814
7A1	0.4147	0.3814	7A2	0.4183	0.3898	7A3	0.4242	0.3919	7A4	0.4203	0.3833
	0.4183	0.3898		0.4221	0.3984		0.4281	0.4006		0.4242	0.3919
	0.4242	0.3919		0.4281	0.4006		0.4342	0.4028		0.4300	0.3939
	0.4203	0.3833		0.4242	0.3919		0.4300	0.3939		0.4259	0.3853
7B1	0.4221	0.3984	7B2	0.4259	0.4073	7B3	0.4322	0.4096	7B4	0.4281	0.4006
	0.4259	0.4073		0.4299	0.4165		0.4364	0.4188		0.4322	0.4096
	0.4322	0.4096		0.4364	0.4188		0.4430	0.4212		0.4385	0.4119
	0.4281	0.4006		0.4322	0.4096		0.4385	0.4119		0.4342	0.4028

PERFORMANCE GROUPS - CHROMATICITY (CONTINUED)

Region	x	y	Region	x	y	Region	x	y	Region	x	y
7C1	0.4342	0.4028	7C2	0.4385	0.4119	7C3	0.4449	0.4141	7C4	0.4403	0.4049
	0.4385	0.4119		0.4430	0.4212		0.4496	0.4236		0.4449	0.4141
	0.4449	0.4141		0.4496	0.4236		0.4562	0.4260		0.4513	0.4164
	0.4403	0.4049		0.4449	0.4141		0.4513	0.4164		0.4465	0.4071
7D1	0.4259	0.3853	7D2	0.4300	0.3939	7D3	0.4359	0.3960	7D4	0.4316	0.3873
	0.4300	0.3939		0.4342	0.4028		0.4403	0.4049		0.4359	0.3960
	0.4359	0.3960		0.4403	0.4049		0.4465	0.4071		0.4418	0.3981
	0.4316	0.3873		0.4359	0.3960		0.4418	0.3981		0.4373	0.3893
8A1	0.4373	0.3893	8A2	0.4418	0.3981	8A3	0.4475	0.3994	8A4	0.4428	0.3906
	0.4418	0.3981		0.4465	0.4071		0.4523	0.4085		0.4475	0.3994
	0.4475	0.3994		0.4523	0.4085		0.4582	0.4099		0.4532	0.4008
	0.4428	0.3906		0.4475	0.3994		0.4532	0.4008		0.4483	0.3919
8B1	0.4465	0.4071	8B2	0.4513	0.4164	8B3	0.4573	0.4178	8B4	0.4523	0.4085
	0.4513	0.4164		0.4562	0.4260		0.4624	0.4274		0.4573	0.4178
	0.4573	0.4178		0.4624	0.4274		0.4687	0.4289		0.4634	0.4193
	0.4523	0.4085		0.4573	0.4178		0.4634	0.4193		0.4582	0.4099
8C1	0.4582	0.4099	8C2	0.4634	0.4193	8C3	0.4695	0.4207	8C4	0.4641	0.4112
	0.4634	0.4193		0.4687	0.4289		0.4750	0.4304		0.4695	0.4207
	0.4695	0.4207		0.4750	0.4304		0.4813	0.4319		0.4756	0.4221
	0.4641	0.4112		0.4695	0.4207		0.4756	0.4221		0.4700	0.4126
8D1	0.4483	0.3919	8D2	0.4532	0.4008	8D3	0.4589	0.4021	8D4	0.4538	0.3931
	0.4532	0.4008		0.4582	0.4099		0.4641	0.4112		0.4589	0.4021
	0.4589	0.4021		0.4641	0.4112		0.4700	0.4126		0.4646	0.4034
	0.4538	0.3931		0.4589	0.4021		0.4646	0.4034		0.4593	0.3944

PERFORMANCE GROUPS - FORWARD VOLTAGE

XLamp XP-E HEW LEDs are tested for forward voltage and sorted into one of the forward voltage bins defined below.

Forward Voltage Group	Minimum Forward Voltage (V) @ 350 mA	Maximum Forward Voltage (V) @ 350 mA
B	1.75	2.0
C	2.0	2.25
D	2.25	2.5
E	2.5	2.75
F	2.75	3.0
G	3.0	3.25
H	3.25	3.5
J	3.5	3.75

CREE'S STANDARD CHROMATICITY REGIONS PLOTTED ON THE 1931 CIE CURVE

ANSI Cool White

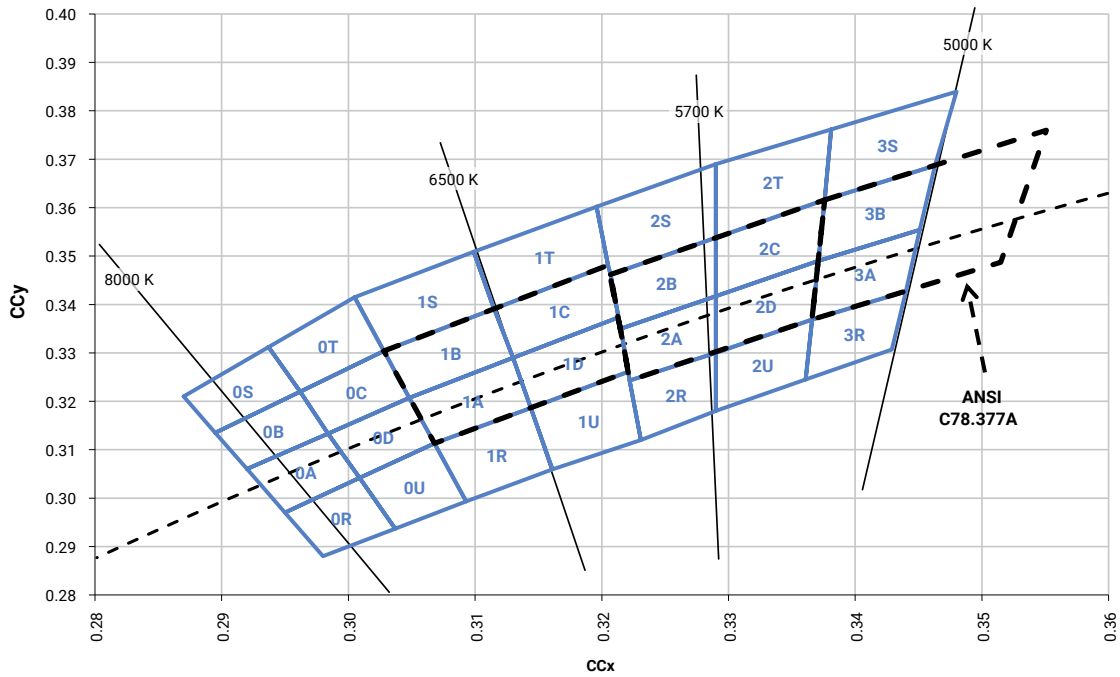

ANSI Neutral White and ANSI Warm White

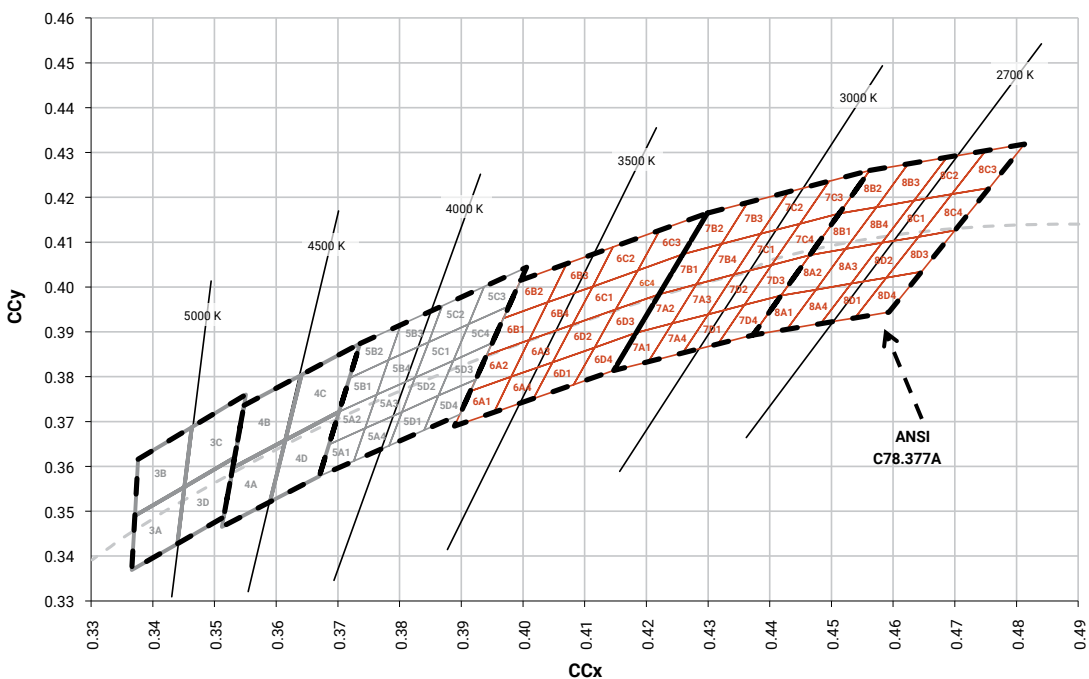

CREE'S STANDARD COOL WHITE KITS PLOTTED ON ANSI STANDARD CHROMATICITY REGIONS

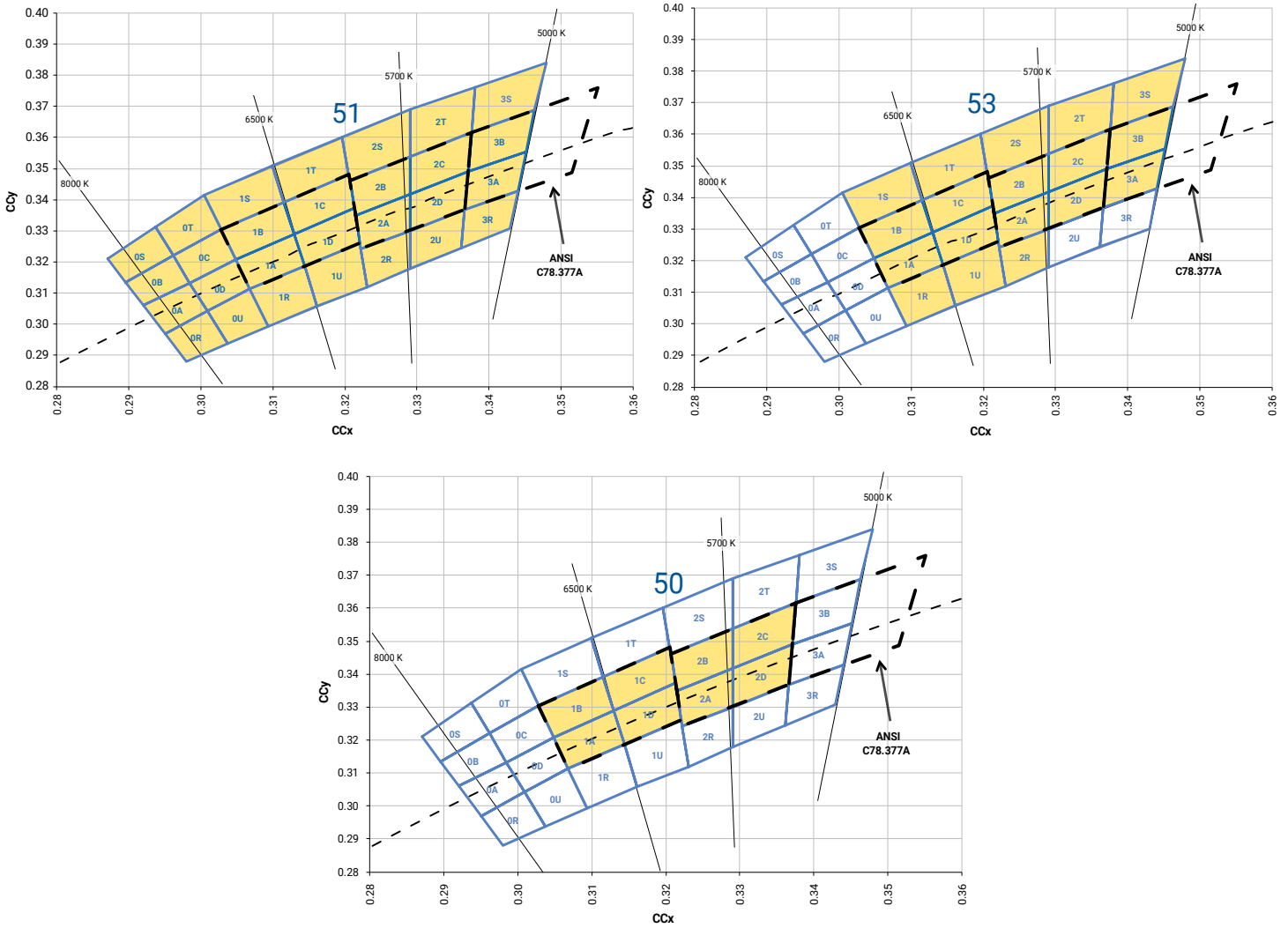

CREE'S STANDARD WARM AND NEUTRAL WHITE KITS PLOTTED ON ANSI STANDARD CHROMATICITY REGIONS

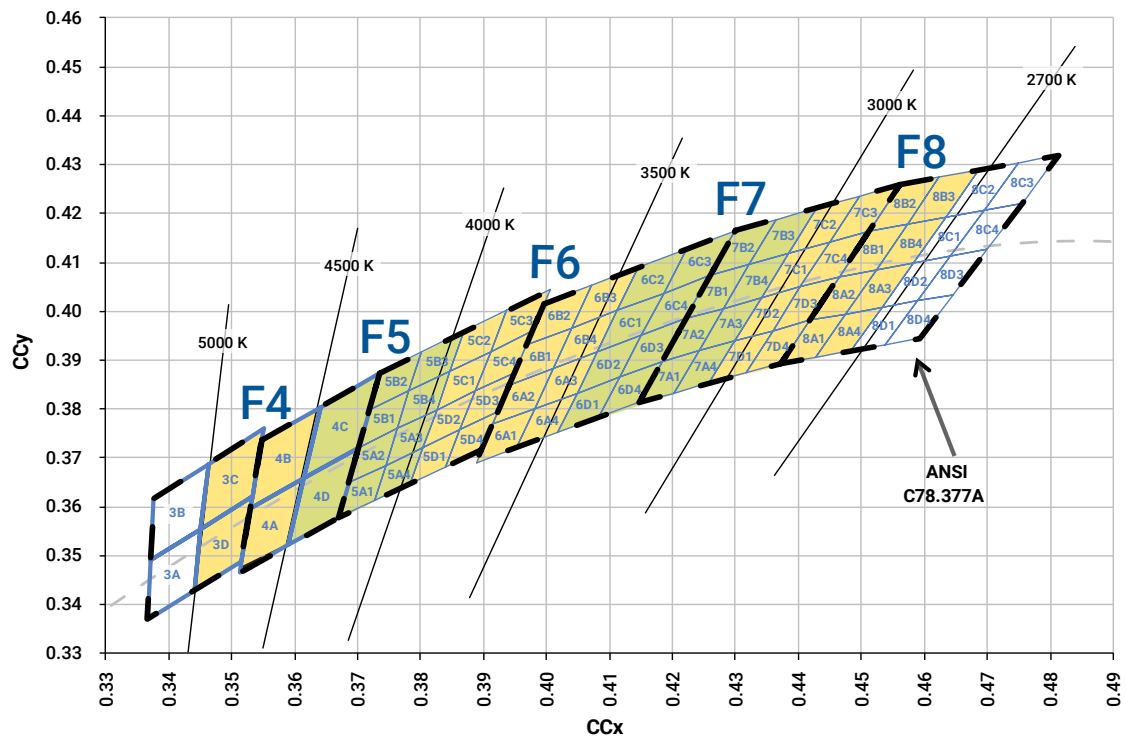
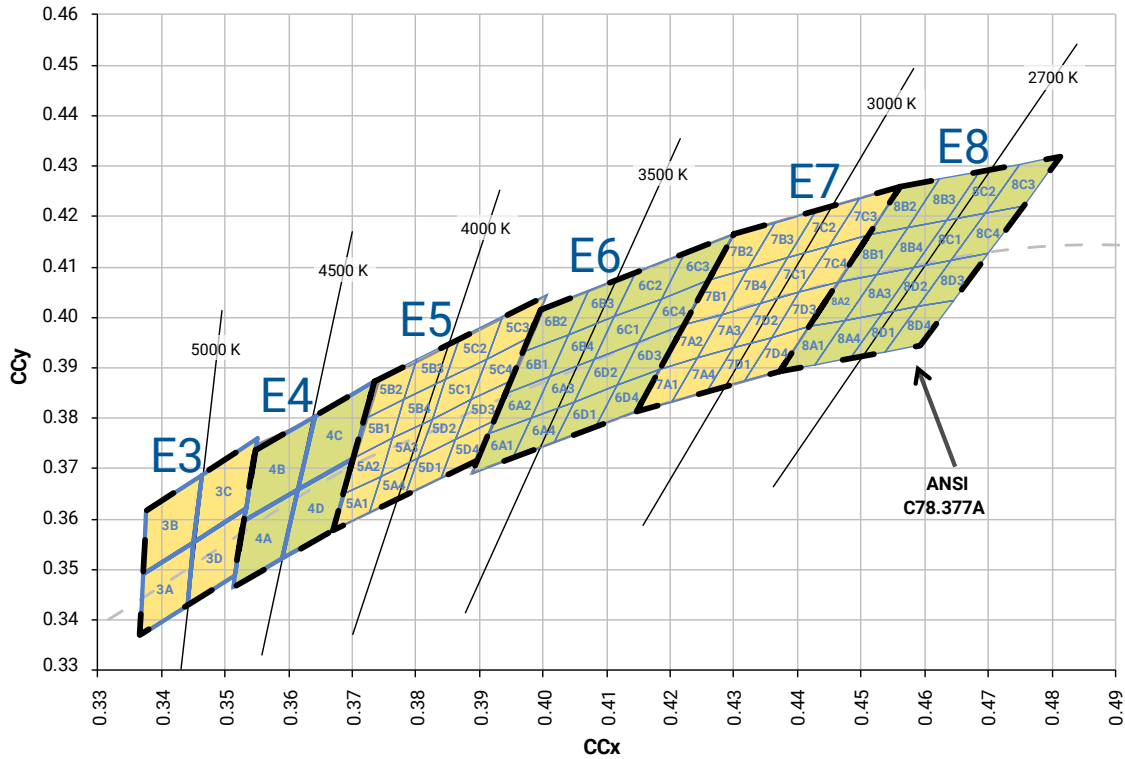

CREE'S STANDARD CHROMATICITY KITS

The following table provides the chromaticity bins associated with chromaticity kits.

Color	CCT	Kit	Chromaticity Bins
Cool White	6200 K	51	0A, 0B, 0C, 0D, 0R, 0S, 0T, 0U, 1A, 1B, 1C, 1D, 1R, 1S, 1T, 1U, 2A, 2B, 2C, 2D, 2R, 2S, 2T, 2U, 3A, 3B, 3R, 3S
	6000 K	53	1A, 1B, 1C, 1D, 1R, 1S, 1T, 1U, 2A, 2B, 2C, 2D, 2R, 2S, 2T, 3A, 3B, 3S
	6200 K	50	1A, 1B, 1C, 1D, 2A, 2B, 2C, 2D
Neutral White	5000 K	E3	3A, 3B, 3C, 3D
	4750 K	F4	3C, 3D, 4A, 4B
	4500 K	E4	4A, 4B, 4C, 4D
	4250 K	F5	4C, 4D, 5A1, 5A2, 5A3, 5A4, 5B1, 5B2, 5B3, 5B4
	4000 K	E5	5A1, 5A2, 5A3, 5A4, 5B1, 5B2, 5B3, 5B4, 5C1, 5C2, 5C3, 5C4, 5D1, 5D2, 5D3, 5D4
Warm White	3750 K	F6	5C1, 5C2, 5C3, 5C4, 5D1, 5D2, 5D3, 5D4, 6A1, 6A2, 6A3, 6A4, 6B1, 6B2, 6B3, 6B4
	3500 K	E6	6A1, 6A2, 6A3, 6A4, 6B1, 6B2, 6B3, 6B4, 6C1, 6C2, 6C3, 6C4, 6D1, 6D2, 6D3, 6D4
	3250 K	F7	6C1, 6C2, 6C3, 6C4, 6D1, 6D2, 6D3, 6D4, 7A1, 7A2, 7A3, 7A4, 7B1, 7B2, 7B3, 7B4
	3000 K	E7	7A1, 7A2, 7A3, 7A4, 7B1, 7B2, 7B3, 7B4, 7C1, 7C2, 7C3, 7C4, 7D1, 7D2, 7D3, 7D4
	2850 K	F8	7C1, 7C2, 7C3, 7C4, 7D1, 7D2, 7D3, 7D4, 8A1, 8A2, 8A3, 8A4, 8B1, 8B2, 8B3, 8B4
	2700 K	E8	8A1, 8A2, 8A3, 8A4, 8B1, 8B2, 8B3, 8B4, 8C1, 8C2, 8C3, 8C4, 8D1, 8D2, 8D3, 8D4

BIN AND ORDER CODE FORMATS

XP-E HEW bin codes and order codes are configured in the following manner:

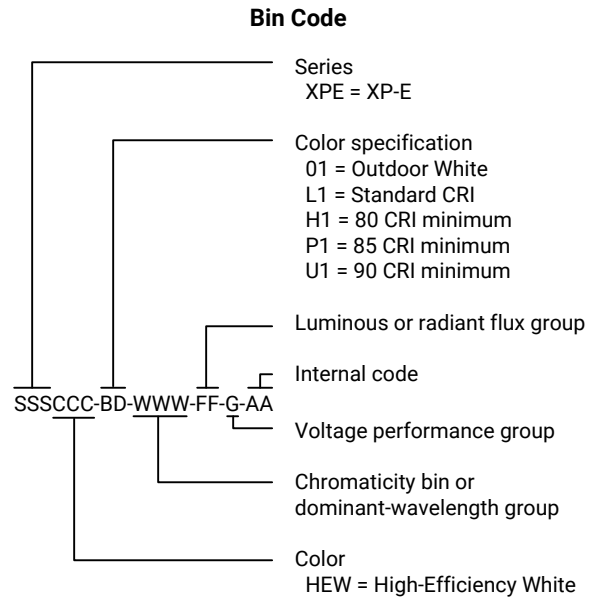
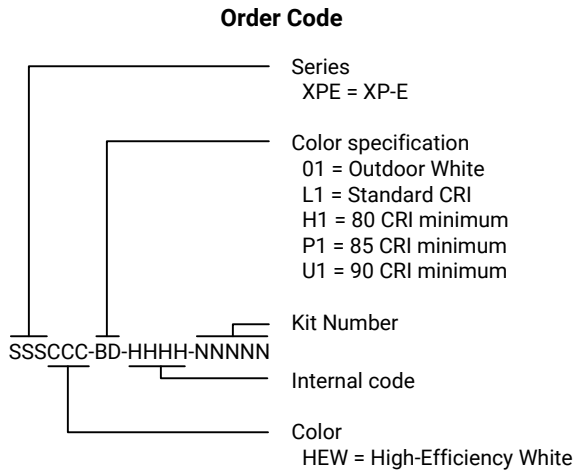

REFLOW SOLDERING CHARACTERISTICS

In testing, Cree has found XLamp XP-E HEW LEDs to be compatible with JEDEC J-STD-020C, using the parameters listed below. As a general guideline, Cree recommends that users follow the recommended soldering profile provided by the manufacturer of the solder paste used, and therefore it is the lamp or luminaire manufacturer’s responsibility to determine applicable soldering requirements.

Note that this general guideline may not apply to all PCB designs and configurations of reflow soldering equipment.

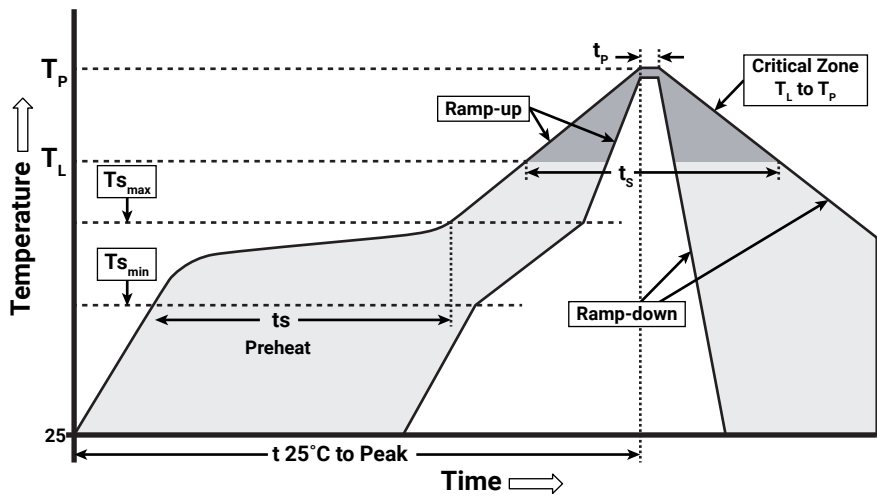

IPC/JEDEC J-STD-020C

Profile Feature	Lead-Free Solder
Average Ramp-Up Rate ($T_{S_{max}}$ to T_P)	1.2 °C/second
Preheat: Temperature Min ($T_{S_{min}}$)	120 °C
Preheat: Temperature Max ($T_{S_{max}}$)	170 °C
Preheat: Time ($t_{S_{min}}$ to $t_{S_{max}}$)	65-150 seconds
Time Maintained Above: Temperature (T_L)	217 °C
Time Maintained Above: Time (t_t)	45-90 seconds
Peak/Classification Temperature (T_P)	235 - 245 °C
Time Within 5 °C of Actual Peak Temperature (t_p)	20-40 seconds
Ramp-Down Rate	1 - 6 °C/second
Time 25 °C to Peak Temperature	4 minutes max.

Note: All temperatures refer to topside of the package, measured on the package body surface.

NOTES

Measurements

The luminous flux, radiant power, chromaticity, forward voltage and CRI measurements in this document are binning specifications only and solely represent product measurements as of the date of shipment. These measurements will change over time based on a number of factors that are not within Cree's control and are not intended or provided as operational specifications for the products. Calculated values are provided for informational purposes only and are not intended or provided as specifications.

Pre-Release Qualification Testing

Please read the [LED Reliability Overview](#) for details of the qualification process Cree applies to ensure long-term reliability for XLamp LEDs and details of Cree's pre-release qualification testing for XLamp LEDs.

Lumen Maintenance

Cree now uses standardized IES LM-80-08 and TM-21-11 methods for collecting long-term data and extrapolating LED lumen maintenance. For information on the specific LM-80 data sets available for this LED, refer to the public [LM-80 results document](#).

Cree currently recommends a maximum drive current of 700 mA for XLamp XP-E High-Efficiency White LEDs in designs seeking the ENERGY STAR® 35,000-hour lifetime rating* ($\geq 94.1\%$ luminous flux @ 6000 hours) or 1000-mA driver current in designs seeking the ENERGY STAR® 25,000-hour lifetime rating ($\geq 91.8\%$ luminous flux @ 6000 hours).

Please read the [Long-Term Lumen Maintenance application note](#) for more details on Cree's lumen maintenance testing and forecasting. Please read the [Thermal Management application note](#) for details on how thermal design, ambient temperature, and drive current affect the LED junction temperature.

* These lifetime ratings are based on the current ENERGY STAR Product Specification for Luminaires (Light Fixtures) V1.0 (February 16, 2011) and ENERGY STAR Program Requirements for Integral LED Lamps V1.4 (May 13, 2011) lumen maintenance criteria.

Moisture Sensitivity

Cree recommends keeping XLamp LEDs in the provided, resealable moisture-barrier packaging (MBP) until immediately prior to soldering. Unopened MBPs that contain XLamp LEDs do not need special storage for moisture sensitivity.

Once the MBP is opened, XLamp XP-E HEW LEDs may be stored as MSL 1 per JEDEC J-STD-033, meaning they have unlimited floor life in conditions of ≤ 30 °C/85% relative humidity (RH). Regardless of the storage condition, Cree recommends sealing any unsoldered LEDs in the original MBP.

RoHS Compliance

The levels of RoHS restricted materials in this product are below the maximum concentration values (also referred to as the threshold limits) permitted for such substances, or are used in an exempted application, in accordance with EU Directive 2011/65/EC (RoHS2), as implemented January 2, 2013. RoHS Declarations for this product can be obtained from your Cree representative or from the [Product Ecology](#) section of the Cree website.

NOTES - CONTINUED

REACH Compliance

REACH substances of very high concern (SVHCs) information is available for this product. Since the European Chemical Agency (ECHA) has published notice of their intent to frequently revise the SVHC listing for the foreseeable future, please contact a Cree representative to insure you get the most up-to-date REACH SVHC Declaration. REACH banned substance information (REACH Article 67) is also available upon request.

UL® Recognized Component

This product meets the requirements to be considered a UL Recognized Component with Level 4 enclosure consideration. The LED package or a portion thereof has been investigated as a fire and electrical enclosure per ANSI/UL 8750.

Vision Advisory

WARNING: Do not look at an exposed lamp in operation. Eye injury can result. For more information about LEDs and eye safety, please refer to the [LED Eye Safety application note](#).

MECHANICAL DIMENSIONS (T_A = 25 °C)

Thermal vias, if present, are not shown on these drawings.

All measurements are ±.13 mm unless otherwise indicated.

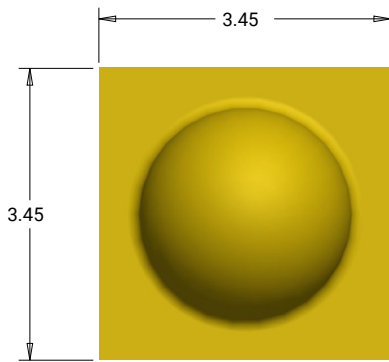

Top View

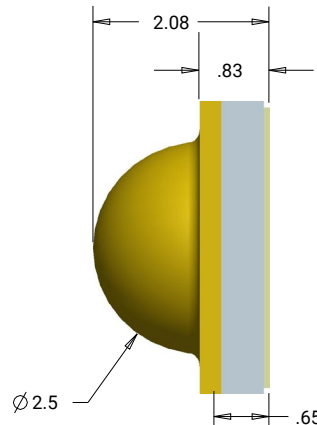

Side View

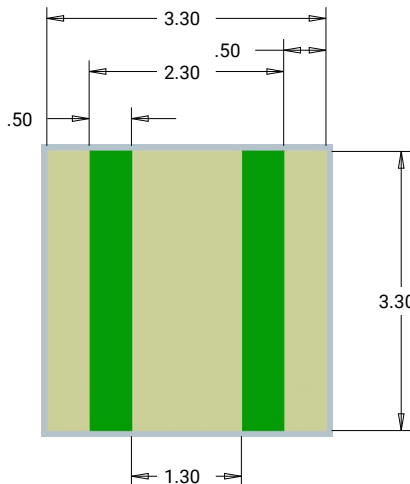

Bottom View

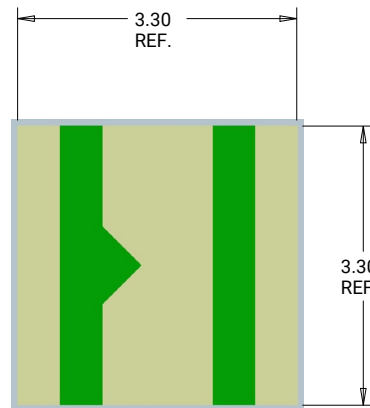

Alternate Bottom View

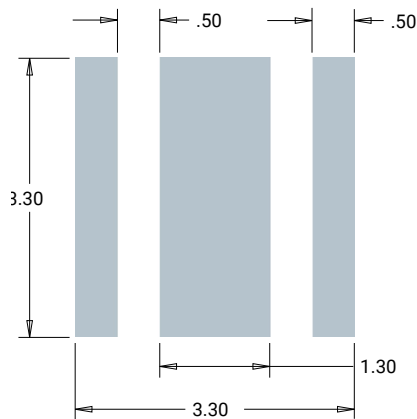

Recommended PCB Solder Pad

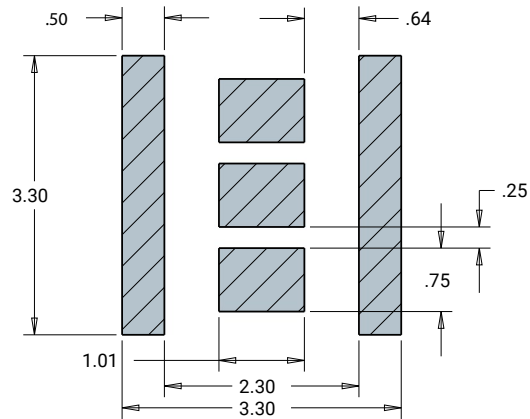

**Recommended Stencil Pattern
(Hatched Area is Open)**

TAPE AND REEL

All Cree carrier tapes conform to EIA-481D, Automated Component Handling Systems Standard.

Except as noted, all dimensions in mm.

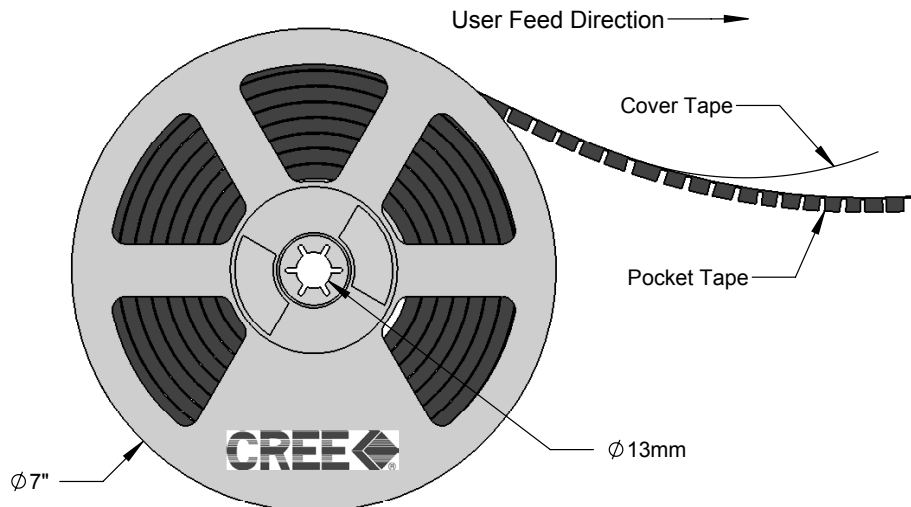
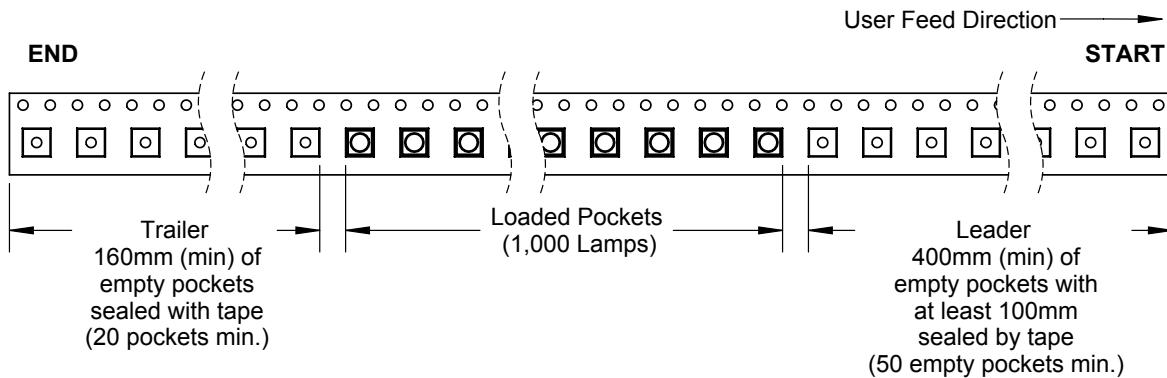
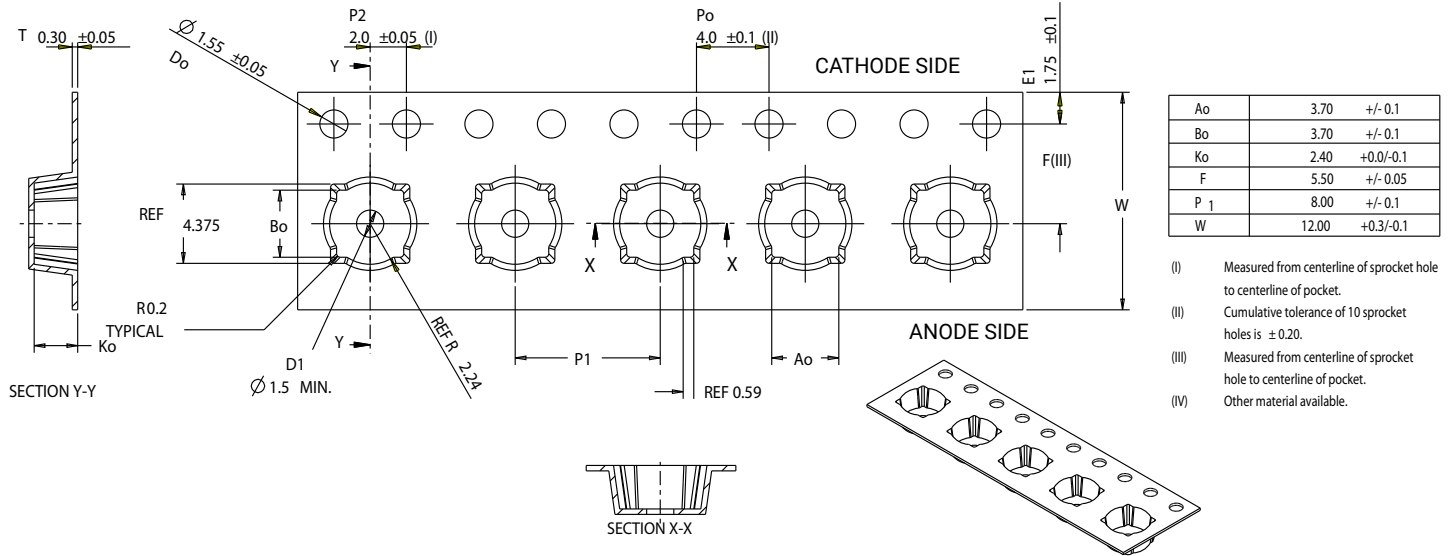

PACKAGING

Unpackaged Reel

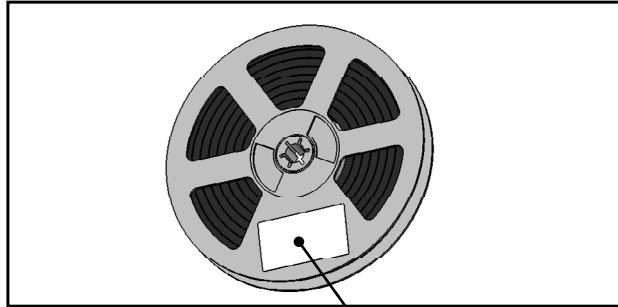

Label with Cree Bin Code,
Quantity, Reel ID

Packaged Reel

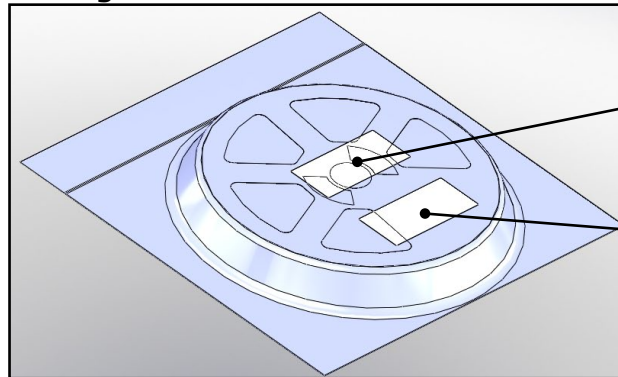

Label with Cree Order Code,
Quantity, Reel ID, PO #

Label with Cree Bin Code,
Quantity, Reel ID

Boxed Reel

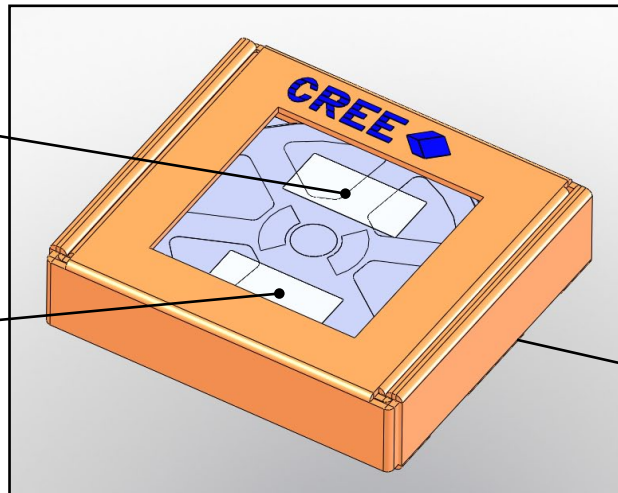

Label with Cree Order Code,
Quantity, Reel ID, PO #

Label with Cree Bin Code,
Quantity, Reel ID

Patent Label
(on bottom of box)