



WP130WCP/2GYW T-1 (3mm) Bi-Level Circuit Board Indicator

DESCRIPTIONS

- The Green source color devices are made with Gallium Phosphide Green Light Emitting Diode
- The Yellow source color devices are made with Gallium Arsenide Phosphide on Gallium Phosphide Yellow Light Emitting Diode

FEATURES

- Bi-level right angle housing LED
- Pre-trimmed leads for pc mounting
- Black case enhances contrast ratio
- Wide viewing angle
- High reliability life measured in years
- Housing UL rating: 94V-0
- Housing material: Type 66 nylon
- RoHS compliant

APPLICATIONS

- Status indicator
- Illuminator
- Signage applications
- Decorative and entertainment lighting
- Commercial and residential architectural lighting

PACKAGE DIMENSIONS

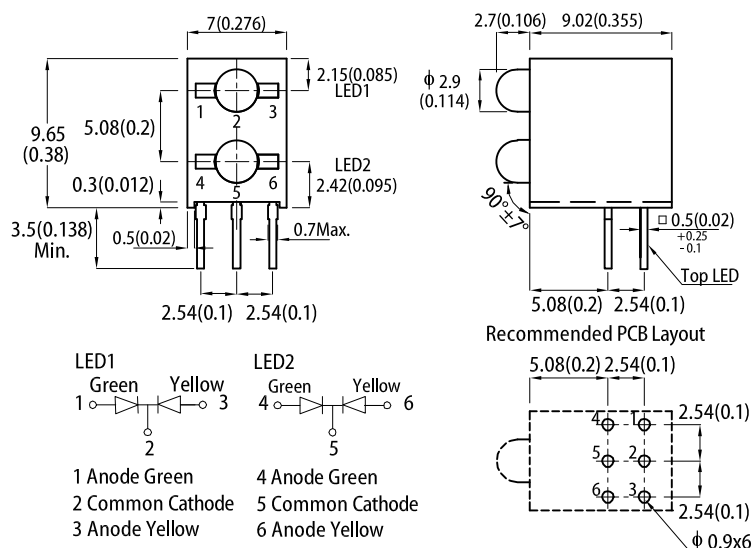

- Notes:
1. All dimensions are in millimeters (inches).
 2. Tolerance is $\pm 0.25(0.01")$ unless otherwise noted.
 3. Lead spacing is measured where leads emerge from the package.
 4. The specifications, characteristics and technical data described in the datasheet are subject to change without prior notice.

SELECTION GUIDE

Part Number	Emitting Color (Material)	Lens Type	Iv (mcd) @ 20mA ^[2]		Viewing Angle ^[1]
			Min.	Typ.	2θ1/2
WP130WCP/2GYW	Green (GaP)	White Diffused	18	40	60°
	Yellow (GaAsP/GaP)		10	20	

- Notes:
1. θ1/2 is the angle from optical centerline where the luminous intensity is 1/2 of the optical peak value.
 2. Luminous intensity / Luminous Flux: +/-15%.
 3. Luminous intensity value is traceable to CIE127-2007 standards.

ELECTRICAL / OPTICAL CHARACTERISTICS at Ta=25°C

Parameter	Symbol	Emitting Color	Value		Unit
			Typ.	Max.	
Wavelength at Peak Emission I _F = 20mA	λ_{peak}	Green Yellow	565 590	-	nm
Dominant Wavelength I _F = 20mA	$\lambda_{dom}^{[1]}$	Green Yellow	568 588	-	nm
Spectral Bandwidth at 50% Φ REL MAX I _F = 20mA	$\Delta\lambda$	Green Yellow	30 35	-	nm
Capacitance	C	Green Yellow	15 20	-	pF
Forward Voltage I _F = 20mA	V _F ^[2]	Green Yellow	2.2 2.1	2.5 2.5	V
Reverse Current (V _R = 5V)	I _R	Green Yellow	-	10 10	uA
Temperature Coefficient of λ_{peak} I _F = 20mA, -10°C ≤ T ≤ 85°C	TC _{λ_{peak}}	Green Yellow	0.1 0.12	-	nm/°C
Temperature Coefficient of λ_{dom} I _F = 20mA, -10°C ≤ T ≤ 85°C	TC _{λ_{dom}}	Green Yellow	0.06 0.07	-	nm/°C
Temperature Coefficient of V _F I _F = 20mA, -10°C ≤ T ≤ 85°C	TC _V	Green Yellow	-2 -2	-	mV/°C

Notes:

1. The dominant wavelength (λ_d) above is the setup value of the sorting machine. (Tolerance λ_d : ±1nm.)
2. Forward voltage: ±0.1V.
3. Wavelength value is traceable to CIE127-2007 standards.
4. Excess driving current and / or operating temperature higher than recommended conditions may result in severe light degradation or premature failure.

ABSOLUTE MAXIMUM RATINGS at T_A=25°C

Parameter	Symbol	Value		Unit
		Green	Yellow	
Power Dissipation	P _D	62.5	75	mW
Reverse Voltage	V _R	5	5	V
Junction Temperature	T _j	110	110	°C
Operating Temperature	T _{op}	-40 to +85		°C
Storage Temperature	T _{stg}	-40 to +85		°C
DC Forward Current	I _F	25	30	mA
Peak Forward Current	I _{FM} ^[1]	140	140	mA
Electrostatic Discharge Threshold (HBM)	-	8000	8000	V
Thermal Resistance (Junction / Ambient)	R _{th JA} ^[2]	500	500	°C/W
Thermal Resistance (Junction / Solder point)	R _{th JS} ^[2]	330	300	°C/W
Lead Solder Temperature ^[3]		260°C For 3 Seconds		
Lead Solder Temperature ^[4]		260°C For 5 Seconds		

Notes:

1. 1/10 Duty Cycle, 0.1ms Pulse Width.
2. R_{th JA} - R_{th JS} Results from mounting on PC board FR4 (pad size ≥ 16 mm² per pad).
3. 2mm below package base.
4. 5mm below package base.
5. Relative humidity levels maintained between 40% and 60% in production area are recommended to avoid the build-up of static electricity – Ref JEDEC/JESD625-A and JEDEC/J-STD-033.

TECHNICAL DATA

RELATIVE INTENSITY vs. WAVELENGTH

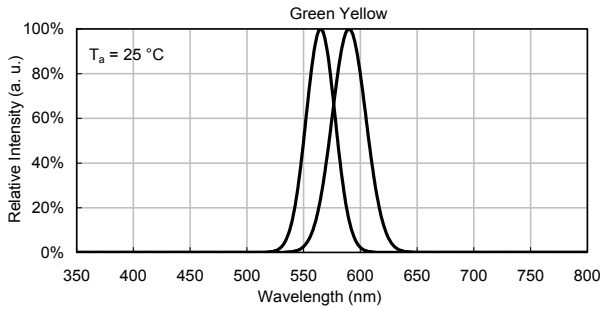

SPATIAL DISTRIBUTION

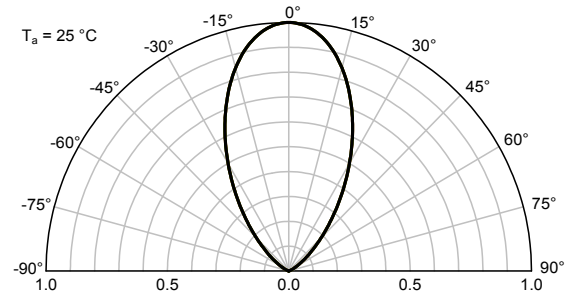

GREEN

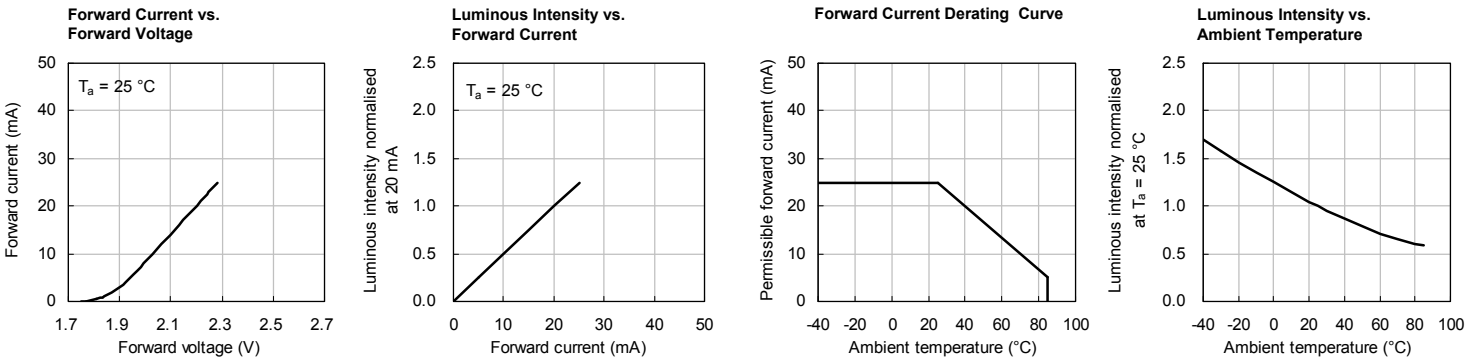

YELLOW

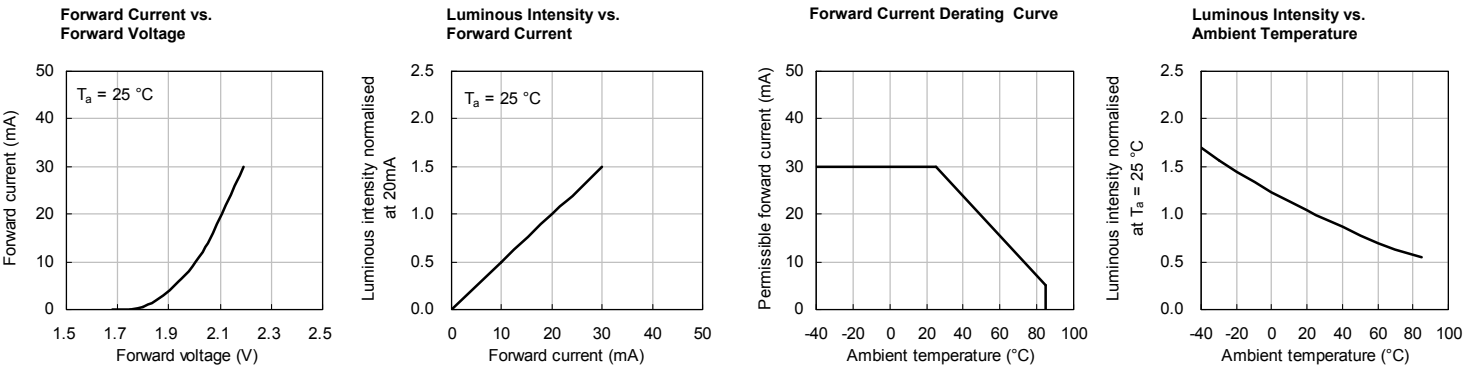

RECOMMENDED WAVE SOLDERING PROFILE

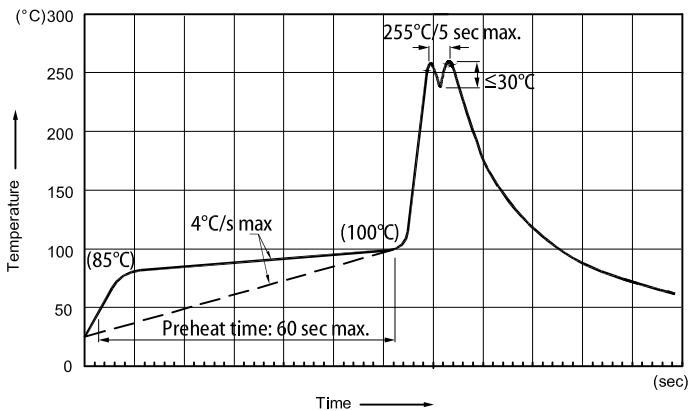

Notes:

1. Recommend pre-heat temperature of 105°C or less (as measured with a thermocouple attached to the LED pins) prior to immersion in the solder wave with a maximum solder bath temperature of 260°C
2. Peak wave soldering temperature between 245°C ~ 255°C for 3 sec (5 sec max).
3. Do not apply stress to the epoxy resin while the temperature is above 85°C.
4. Fixtures should not incur stress on the component when mounting and during soldering process.
5. SAC 305 solder alloy is recommended.
6. No more than one wave soldering pass.

PACKING & LABEL SPECIFICATIONS

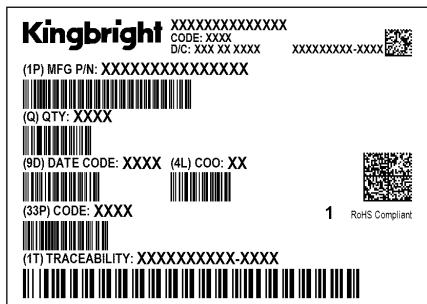
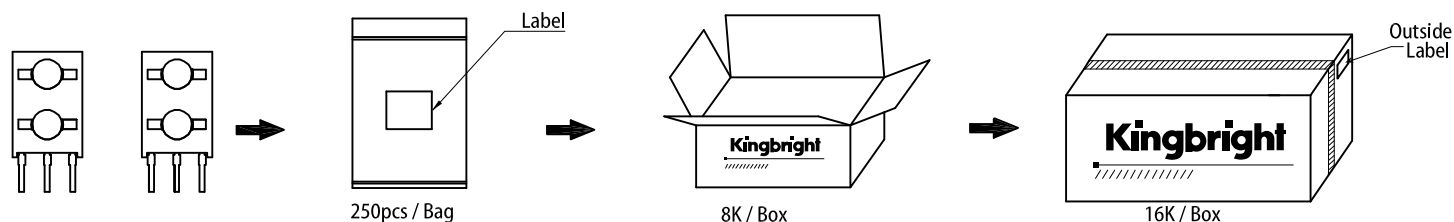

PRECAUTIONS

Storage Conditions

1. Avoid continued exposure to the condensing moisture environment and keep the product away from rapid transitions in ambient temperature.
2. LEDs should be stored with temperature $\leq 30^{\circ}\text{C}$ and relative humidity $< 60\%$.
3. Product in the original sealed package is recommended to be assembled within 72 hours of opening.
Product in opened package for more than a week should be baked for 30 (+10/-0) hours at 85 ~ 100°C.

LED Mounting Method

1. The lead pitch of the LED must match the pitch of the mounting holes on the PCB during component placement.
Lead-forming may be required to insure the lead pitch matches the hole pitch.
Refer to the figure below for proper lead forming procedures.

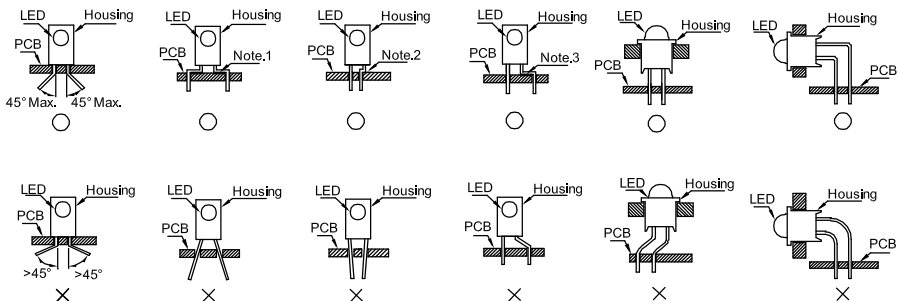

Note 1-3: Do not route PCB trace in the contact area between the leadframe and the PCB to prevent short-circuits.

" o " Correct mounting method " x " Incorrect mounting method

Lead Forming Procedures

1. During soldering, component covers and holders should leave clearance to avoid placing damaging stress on the LED during soldering.
2. The tip of the soldering iron should never touch the lens epoxy.
3. Through-hole LEDs are incompatible with reflow soldering.
4. If the LED will undergo multiple soldering passes or face other processes where the part may be subjected to intense heat, please check with Kingbright for compatibility.

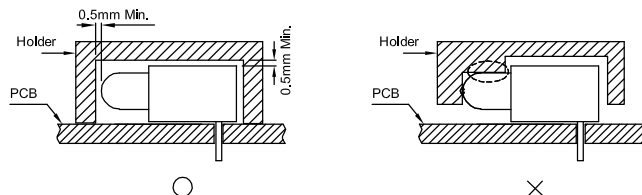

PRECAUTIONARY NOTES

1. The information included in this document reflects representative usage scenarios and is intended for technical reference only.
2. The part number, type, and specifications mentioned in this document are subject to future change and improvement without notice. Before production usage customer should refer to the latest datasheet for the updated specifications.
3. When using the products referenced in this document, please make sure the product is being operated within the environmental and electrical limits specified in the datasheet. If customer usage exceeds the specified limits, Kingbright will not be responsible for any subsequent issues.
4. The information in this document applies to typical usage in consumer electronics applications. If customer's application has special reliability requirements or have life-threatening liabilities, such as automotive or medical usage, please consult with Kingbright representative for further assistance.
5. The contents and information of this document may not be reproduced or re-transmitted without permission by Kingbright.
6. All design applications should refer to Kingbright application notes available at <http://www.KingbrightUSA.com/ApplicationNotes>