



VN771K-E

QUAD SMART POWER SOLID STATE RELAY FOR COMPLETE H BRIDGE CONFIGURATIONS

Table 1. General Features

Type	R _{DS(on)}	I _{OUT}	V _{CC}
VN771K-E	95mΩ (*)	9A (**)	36V

Note: (*) Total resistance of one side in bridge configuration.

Note: (**) Typical current limitation value.

- SUITED AS LOW VOLTAGE BRIDGE
- LINEAR CURRENT LIMITATION
- VERY LOW STAND-BY POWER DISSIPATION
- SHORT CIRCUIT PROTECTED
- STATUS FLAG DIAGNOSTIC (OPEN DRAIN)
- INTEGRATED CLAMPING CIRCUITS
- UNDERVOLTAGE PROTECTION
- ESD PROTECTION
- IN COMPLIANCE WITH THE 2002/95/EC EUROPEAN DIRECTIVE

DESCRIPTION

The VN771K-E is a device formed by three monolithic chips housed in a standard SO-28 package: a double high side and two low side switches. Both the double high side and low side switches are made using STMicroelectronics VIPower™ M0-3 Technology. This device is suitable to drive a DC motor in a bridge configuration as well as to be used as a quad switch for any low voltage application.

Figure 1. Package

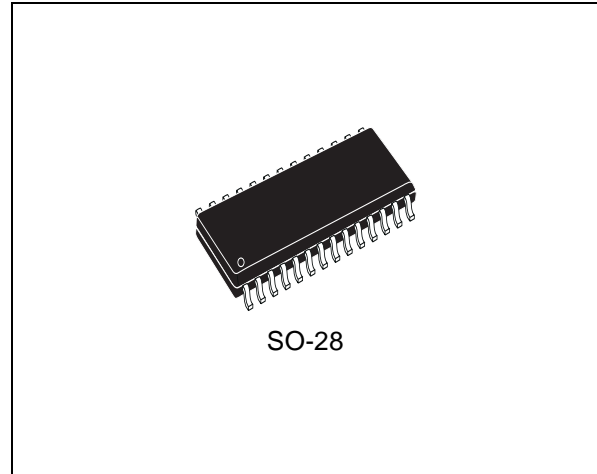

The dual high side switches have built-in thermal shutdown to protect the chips from overtemperature and current limiter blocks to protect the device from short circuit. Status output is provided to indicate open load in off and on state and overtemperature. The low side switches are two OMNIFET II types (fully autoprotected Power MOSFET in VIPower™ technology). They have built-in thermal shutdown, linear current limitation and overvoltage clamping. Fault feedback for thermal intervention can be detected by monitoring the voltage at the input pin.

Table 2. Order Codes

Package	Tube	Tape and Reel
SO-28	VN771K-E	VN771KTR-E

Figure 2. Block Diagram

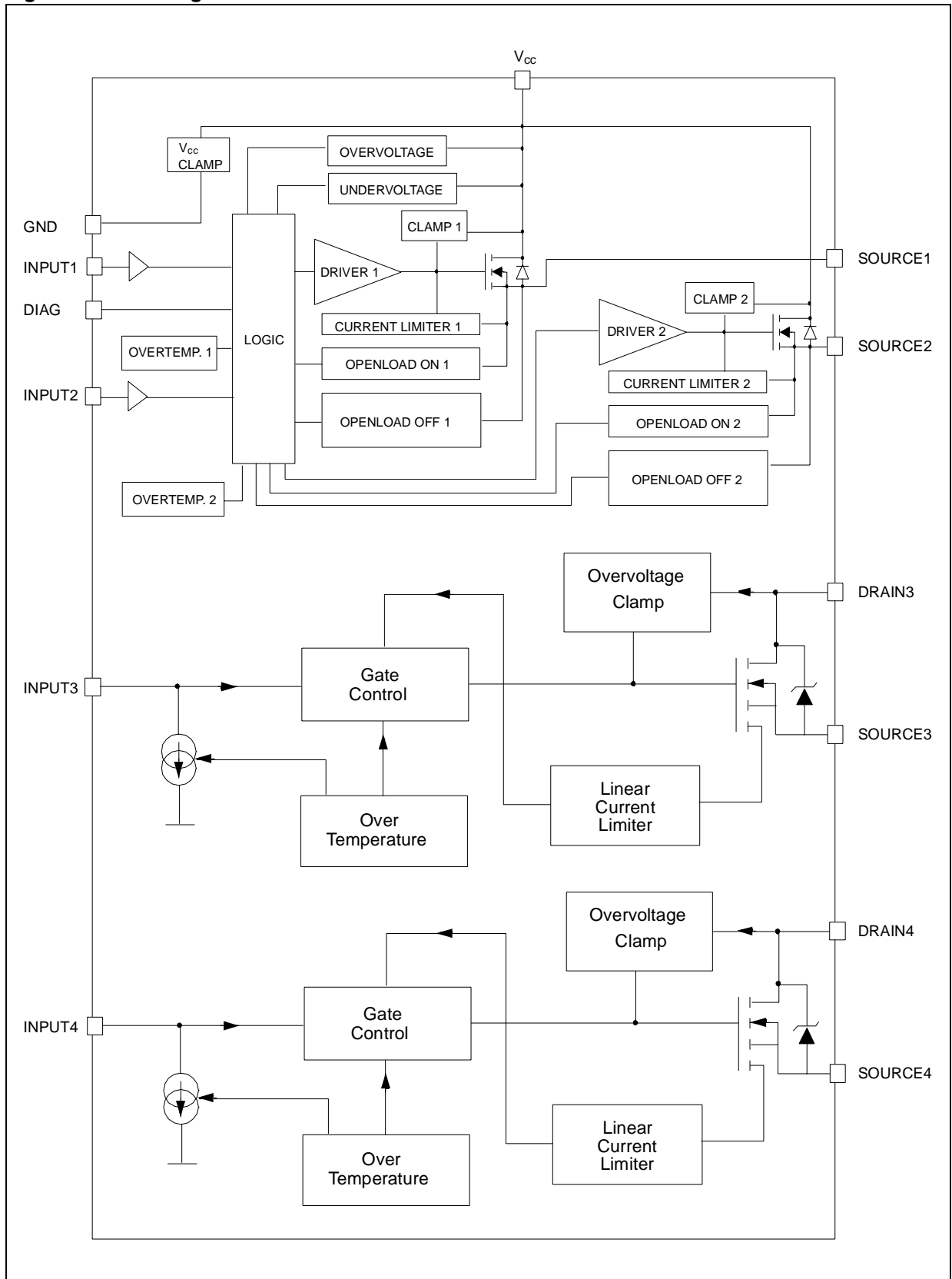

Table 3. Pin Function

No	NAME	FUNCTION
1, 3, 25, 28	DRAIN 3	Drain of Switch 3 (low-side switch)
2	INPUT 3	Input of Switch 3 (low-side switch)
4, 11	N.C.	Not Connected
5, 10, 19, 24	V _{CC}	Drain of Switches 1 and 2 (high-side switches) and Power Supply Voltage
6	GND	Ground of Switches 1 and 2 (high-side switches)
7	INPUT 1	Input of Switch 1 (high-side switches)
8	DIAGNOSTIC	Diagnostic of Switches 1 and 2 (high-side switches)
9	INPUT 2	Input of Switch 2 (high-side switch)
12, 14, 15, 18	DRAIN 4	Drain of switch 4 (low-side switch)
13	INPUT 4	Input of Switch 4 (low-side switch)
16, 17	SOURCE 4	Source of Switch 4 (low-side switch)
20, 21	SOURCE 2	Source of Switch 2 (high-side switch)
22, 23	SOURCE 1	Source of Switch 1 (high-side switch)
26, 27	SOURCE 3	Source of Switch 3 (low-side switch)

Figure 3. Configuration Diagram (Top View)

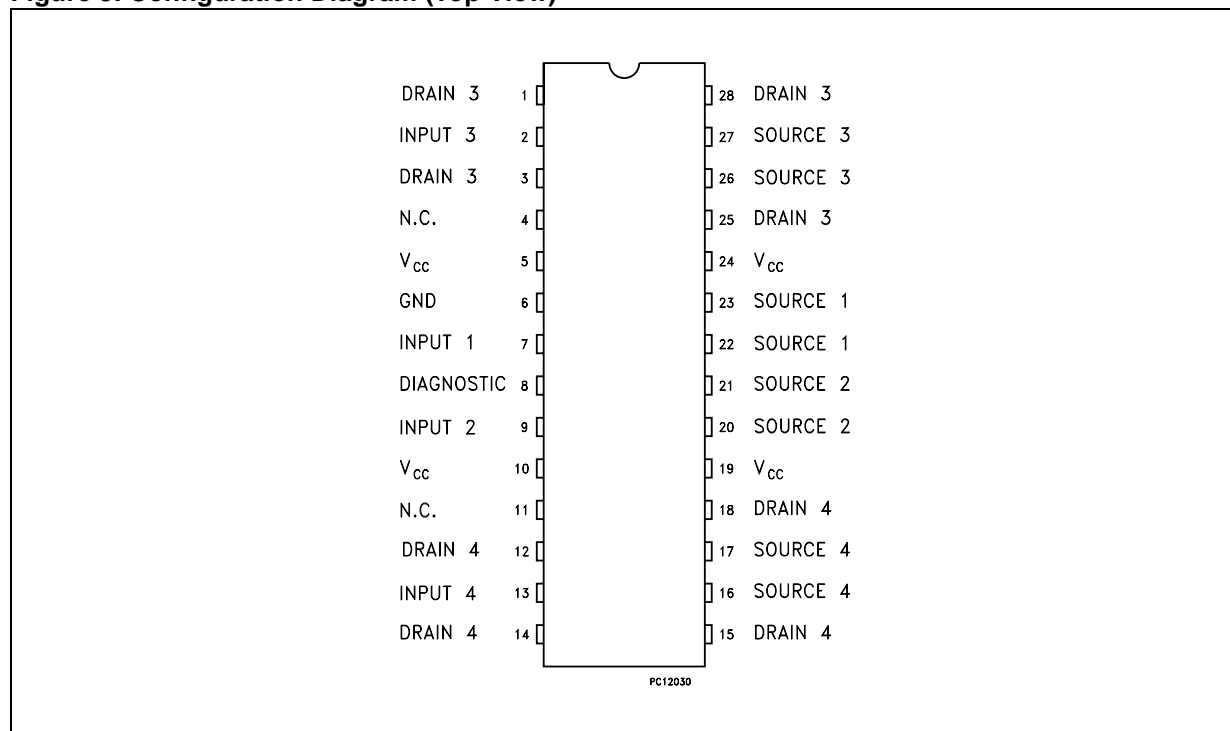

Table 4. Thermal Data

Symbol	Parameter	Value	Unit
R _{thj-case}	Thermal Resistance Junction-case (High-side switch) MAX	20	°C/W
R _{thj-case}	Thermal Resistance Junction-case (Low-side switch) MAX	20	°C/W
R _{thj-amb}	Thermal Resistance Junction-ambient MAX	60	°C/W

ABSOLUTE MAXIMUM RATINGS

Table 5. Dual High Side Switch

Symbol	Parameter	Value	Unit
V _{CC}	DC Supply Voltage	41	V
- V _{CC}	Reverse DC Supply Voltage	- 0.3	V
- I _{GND}	DC Reverse Ground Pin Current	- 200	mA
I _{OUT}	DC Output Current	Internally Limited	A
- I _{OUT}	Reverse DC Output Current	- 6	A
I _{IN}	DC Input Current	+/- 10	mA
I _{STAT}	DC Status Current	+/- 10	mA
V _{ESD}	Electrostatic Discharge (Human Body Model: R=1.5KΩ; C=100pF)		
	- INPUT	4000	V
	- STATUS	4000	V
	- OUTPUT	5000	V
	- V _{CC}	5000	V
P _{tot}	Power Dissipation T _c =25°C	6	W
T _j	Junction Operating Temperature	Internally Limited	°C
T _c	Case Operating Temperature	- 40 to 150	°C
T _{stg}	Storage Temperature	- 55 to 150	°C

Table 6. Low Side Switch

Symbol	Parameter	Value	Unit
V _{DS}	Drain-source Voltage (V _{IN} =0V)	Internally Clamped	V
V _{IN}	Input Voltage	Internally Clamped	V
I _{IN}	Input Current	+/-20	mA
R _{IN MIN}	Minimum Input Series Impedance	10	Ω
I _D	Drain Current	Internally Limited	A
I _R	Reverse DC Output Current	-15	A
V _{ESD1}	Electrostatic Discharge (R=1.5KΩ, C=100pF)	4000	V
V _{ESD2}	Electrostatic Discharge on output pin only (R=330Ω, C=150pF)	16500	V
P _{tot}	Total Dissipation at T _c =25°C	6	W
T _j	Operating Junction Temperature	Internally limited	°C
T _c	Case Operating Temperature	Internally limited	°C
T _{stg}	Storage Temperature	-55 to 150	°C

ELECTRICAL CHARACTERISTICS FOR DUAL HIGH SIDE SWITCH(8V < V_{CC} < 36V; -40°C < T_j < 150°C, unless otherwise specified) (Per each channel)**Table 7. Power Outputs**

Symbol	Parameter	Test Conditions	Min	Typ	Max	Unit
V _{CC} ⁽¹⁾	Operating Supply Voltage		5.5	13	36	V
V _{USD} ⁽¹⁾	Undervoltage Shut-down		3	4	5.5	V
V _{Ov} ⁽¹⁾	Overvoltage Shut-down		36			V
R _{ON}	On State Resistance	I _{OUT} = 2A; T _j = 25°C I _{OUT} = 2A; V _{CC} > 8V			60 120	mΩ mΩ
I _S ⁽¹⁾	Supply Current	Off State; V _{CC} = 13V; V _{IN} = V _{OUT} = 0V Off State; V _{CC} = 13V; T _j = 25°C; V _{IN} = V _{OUT} = 0V On State; V _{CC} = 13V		12 12 5	40 25 7	μA μA mA
I _{L(off1)}	Off State Output Current	V _{IN} = V _{OUT} = 0V; V _{CC} = 36V; T _j = 125°C	0		50	μA
I _{L(off2)}	Off State Output Current	V _{IN} = 0V; V _{OUT} = 3.5V	-75		0	μA
I _{L(off3)}	Off State Output Current	V _{IN} = V _{OUT} = 0V; V _{CC} = 13V; T _j = 125°C			5	μA
I _{L(off4)}	Off State Output Current	V _{IN} = V _{OUT} = 0V; V _{CC} = 13V; T _j = 25°C			3	μA

Note: ⁽¹⁾ Per device.**Table 8. Switching (V_{CC} = 13V)**

Symbol	Parameter	Test Conditions	Min	Typ	Max	Unit
t _{d(on)}	Turn-on Delay Time	R _L = 6.5Ω from V _{IN} rising edge to V _{OUT} = 1.3V		30		μs
t _{d(off)}	Turn-off Delay Time	R _L = 6.5Ω from V _{IN} falling edge to V _{OUT} = 11.7V		30		μs
dV _{OUT} / dt _(on)	Turn-on Voltage Slope	R _L = 6.5Ω from V _{OUT} = 1.3V to V _{OUT} = 10.4V		See relative diagram		V/μs
dV _{OUT} / dt _(off)	Turn-off Voltage Slope	R _L = 6.5Ω from V _{OUT} = 11.7V to V _{OUT} = 1.3V		See relative diagram		V/μs

Table 9. Logic Input

Symbol	Parameter	Test Conditions	Min	Typ	Max	Unit
V _{IL}	Input Low Level				1.25	V
I _{IL}	Low Level Input Current	V _{IN} = 1.25V	1			μA
V _{IH}	Input High Level		3.25			V
I _{IH}	High Level Input Current	V _{IN} = 3.25V			10	μA
V _{I(hyst)}	Input Hysteresis Voltage		0.5			V
V _{ICL}	Input Clamp Voltage	I _{IN} = 1mA I _{IN} = -1mA	6	6.8 -0.7	8	V V

Table 10. Status Pin

Symbol	Parameter	Test Conditions	Min	Typ	Max	Unit
V _{STAT}	Status Low Output Voltage	I _{STAT} = 1.6 mA			0.5	V
I _{LSTAT}	Status Leakage Current	Normal Operation; V _{STAT} = 5V			10	μA
C _{STAT}	Status Pin Input Capacitance	Normal Operation; V _{STAT} = 5V			100	pF
V _{SCL}	Status Clamp Voltage	I _{STAT} = 1mA I _{STAT} = -1mA	6	6.8 -0.7	8	V V

ELECTRICAL CHARACTERISTICS FOR DUAL HIGH SIDE SWITCH (continued)

Table 11. Protections

Symbol	Parameter	Test Conditions	Min	Typ	Max	Unit
T _{TSD}	Shut-down Temperature		150	175	200	°C
T _R	Reset Temperature		135			°C
T _{hyst}	Thermal Hysteresis		7	15		°C
t _{SDL}	Status Delay in Overload Conditions	T _j >T _{TSD}			20	μs
I _{lim}	Current limitation	T _j =125°C 5.5V<V _{CC} <36V	6 8.5	9	15 15 15	A A A
V _{demag}	Turn-off Output Clamp Voltage	I _{OUT} =2A; L= 6mH	V _{CC} -41	V _{CC} -48	V _{CC} -55	V

Table 12. Openload Detection

Symbol	Parameter	Test Conditions	Min	Typ	Max	Unit
I _{OL}	Openload ON State Detection Threshold	V _{IN} =5V	50	100	200	mA
t _{DOL(on)}	Openload ON State Detection Delay	I _{OUT} =0A			200	μs
V _{OL}	Openload OFF State Voltage Detection Threshold	V _{IN} =0V	1.5	2.5	3.5	V
T _{DOL(off)}	Openload Detection Delay at Turn Off				1000	μs

ELECTRICAL CHARACTERISTICS FOR LOW SIDE SWITCHES

(-40°C < T_j < 150°C, unless otherwise specified)

Table 13. Off

Symbol	Parameter	Test Conditions	Min	Typ	Max	Unit
V _{CLAMP}	Drain-source Clamp Voltage	V _{IN} =0V; I _D =7A	40	45	55	V
V _{CLTH}	Drain-source Clamp Threshold Voltage	V _{IN} =0V; I _D =2mA	36			V
V _{INTH}	Input Threshold Voltage	V _{DS} =V _{IN} ; I _D =1mA	0.5		2.5	V
I _{ISS}	Supply Current from Input Pin	V _{DS} =0V; V _{IN} =5V		100	150	μA
V _{INCL}	Input-Source Clamp Voltage	I _{IN} =1mA I _{IN} =-1mA	6 -1.0	6.8	8 -0.3	V
I _{DSS}	Zero Input Voltage Drain Current (V _{IN} =0V)	V _{DS} =13V; V _{IN} =0V; T _j =25°C V _{DS} =25V; V _{IN} =0V			30 75	μA

Table 14. On

Symbol	Parameter	Test Conditions	Min	Typ	Max	Unit
R _{DS(on)}	Static Drain-source On Resistance	V _{IN} =5V; I _D =7A; T _j =25°C V _{IN} =5V; I _D =7A			35 70	mΩ

ELECTRICAL CHARACTERISTICS FOR LOW SIDE SWITCHES (continued)(T_j=25°C, unless otherwise specified)**Table 15. Dynamic**

Symbol	Parameter	Test Conditions	Min	Typ	Max	Unit
g _{fs} (*)	Forward Transconductance	V _{DD} =13V; I _D =7A		18		S
C _{oss}	Output Capacitance	V _{DS} =13V; f=1MHz; V _{IN} =0V		400		pF

Table 16. Switching

Symbol	Parameter	Test Conditions	Min	Typ	Max	Unit
t _{d(on)}	Turn-on Delay Time	V _{DD} =15V; I _D =7A V _{gen} =5V; R _{gen} =R _{IN} MIN=10Ω		80	250	ns
t _r	Rise Time			350	1000	ns
t _{d(off)}	Turn-off Delay Time			450	1350	ns
t _f	Fall Time			150	500	ns
t _{d(on)}	Turn-on Delay Time	V _{DD} =15V; I _D =7A V _{gen} =5V; R _{gen} =2.2KΩ		1.5	4.5	μs
t _r	Rise Time			9.7	30.0	μs
t _{d(off)}	Turn-off Delay Time			9	25.0	μs
t _f	Fall Time			10.2	30.0	μs
(di/dt) _{on}	Turn-on Current Slope	V _{DD} =15V; I _D =7A V _{gen} =5V; R _{gen} =R _{IN} MIN=10Ω		16		A/μs
Q _i	Total Input Charge	V _{DD} =12V; I _D =7A; V _{IN} =5V; I _{gen} =2.13mA		36.8		nC

Table 17. Source Drain Diode

Symbol	Parameter	Test Conditions	Min	Typ	Max	Unit
V _{SD} (*)	Forward On Voltage	I _{SD} =7A; V _{IN} =0V		0.8		V
t _{rr}	Reverse Recovery Time	I _{SD} =7A; di/dt=40A/μs V _{DD} =30V; L=200μH		300		ns
Q _{rr}	Reverse Recovery Charge			0.8		μC
I _{RRM}	Reverse Recovery Current			5		A

Note: (*) Pulsed: Pulse duration = 300μs, duty cycle 1.5 %

Table 18. Protections (-40°C < T_j < 150°C, unless otherwise specified)

Symbol	Parameter	Test Conditions	Min	Typ	Max	Unit
I _{lim}	Drain Current Limit	V _{IN} =5V; V _{DS} =13V	12	18	24	A
		V _{IN} =5V; V _{DS} =13V; T _j =125°C	15		24	A
t _{dlim}	Step Response Current Limit	V _{IN} =5V; V _{DS} =13V		45		μs
T _{jsh}	Overtemperature Shutdown		150	175		°C
T _{jrs}	Overtemperature Reset		135			°C
I _{gf}	Fault Sink Current	V _{IN} =5V; V _{DS} =13V; T _j =T _{jsh}	10	15	20	mA
E _{as}	Single Pulse	starting T _j =25°C; V _{DD} =24V	400			mJ
	Avalanche Energy	V _{IN} =5V; R _{gen} =R _{IN} MIN=10Ω; L=24mH				

DUAL HIGH-SIDE SWITCH

Figure 4. Switching Time Waveforms

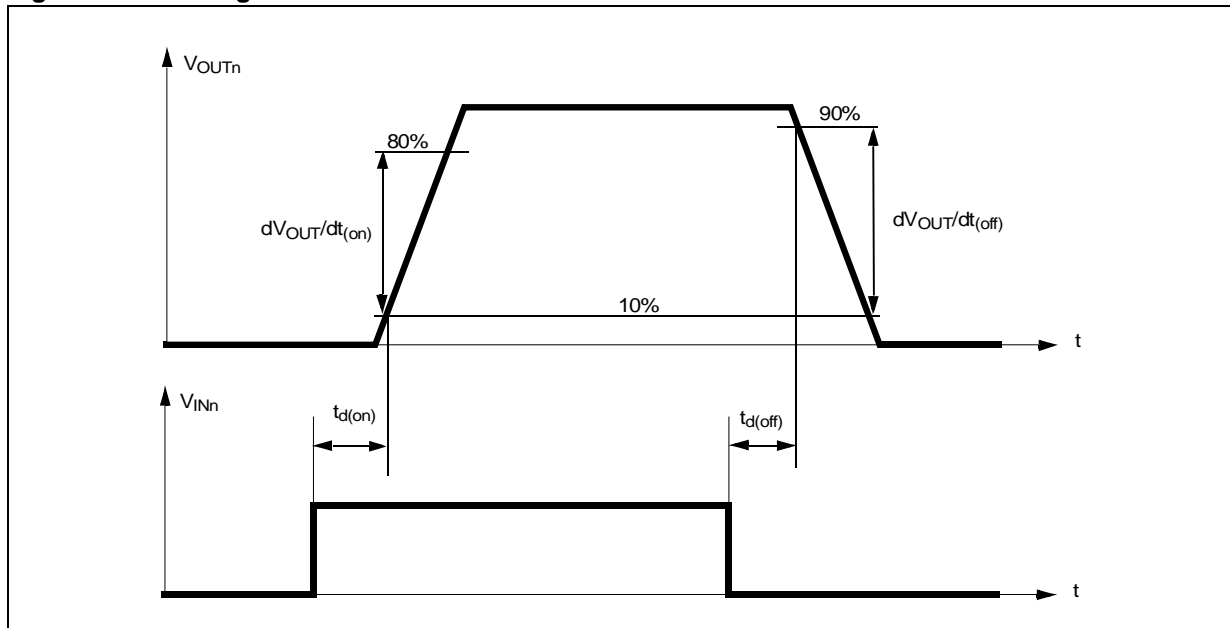

Table 19. Truth Table

CONDITIONS	INPUT	OUTPUT	STATUS
Normal Operation	L	L	H
	H	H	H
Current Limitation	L	L	H
	H	X	($T_j < T_{TSD}$) H
	H	X	($T_j > T_{TSD}$) L
Overtemperature	L	L	H
	H	L	L
Undervoltage	L	L	X
	H	L	X
Overvoltage	L	L	H
	H	L	H
Output Voltage > V_{OL}	L	H	L
	H	H	H
Output Current < I_{OL}	L	L	H
	H	H	L

Figure 5.

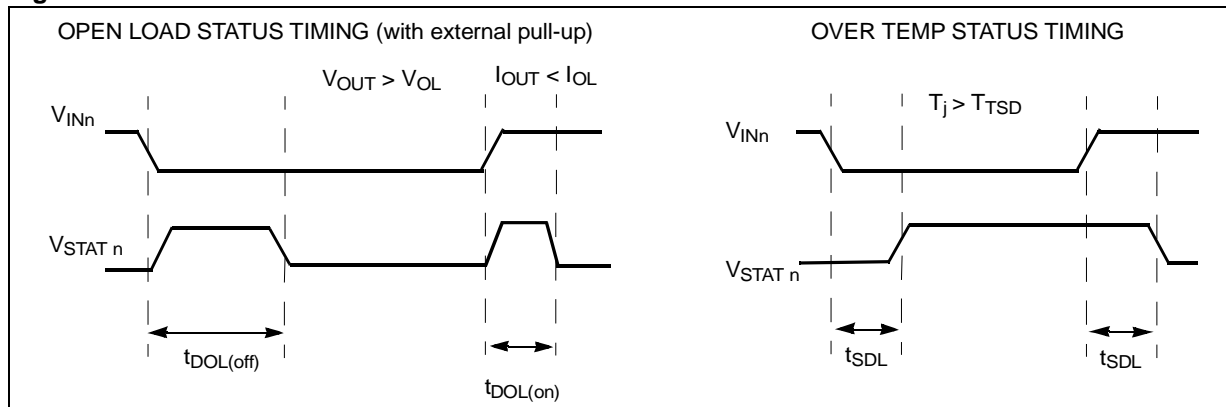

Figure 6. Typical Application Diagram

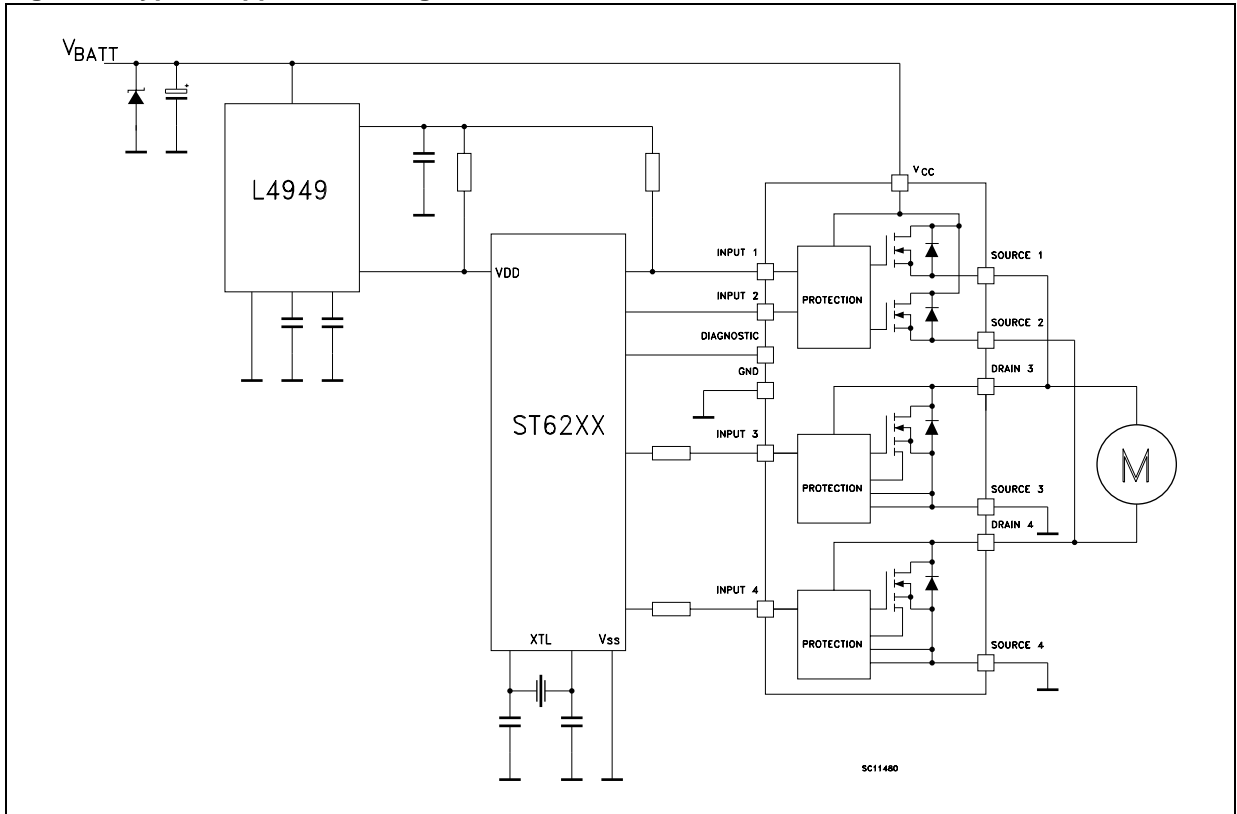
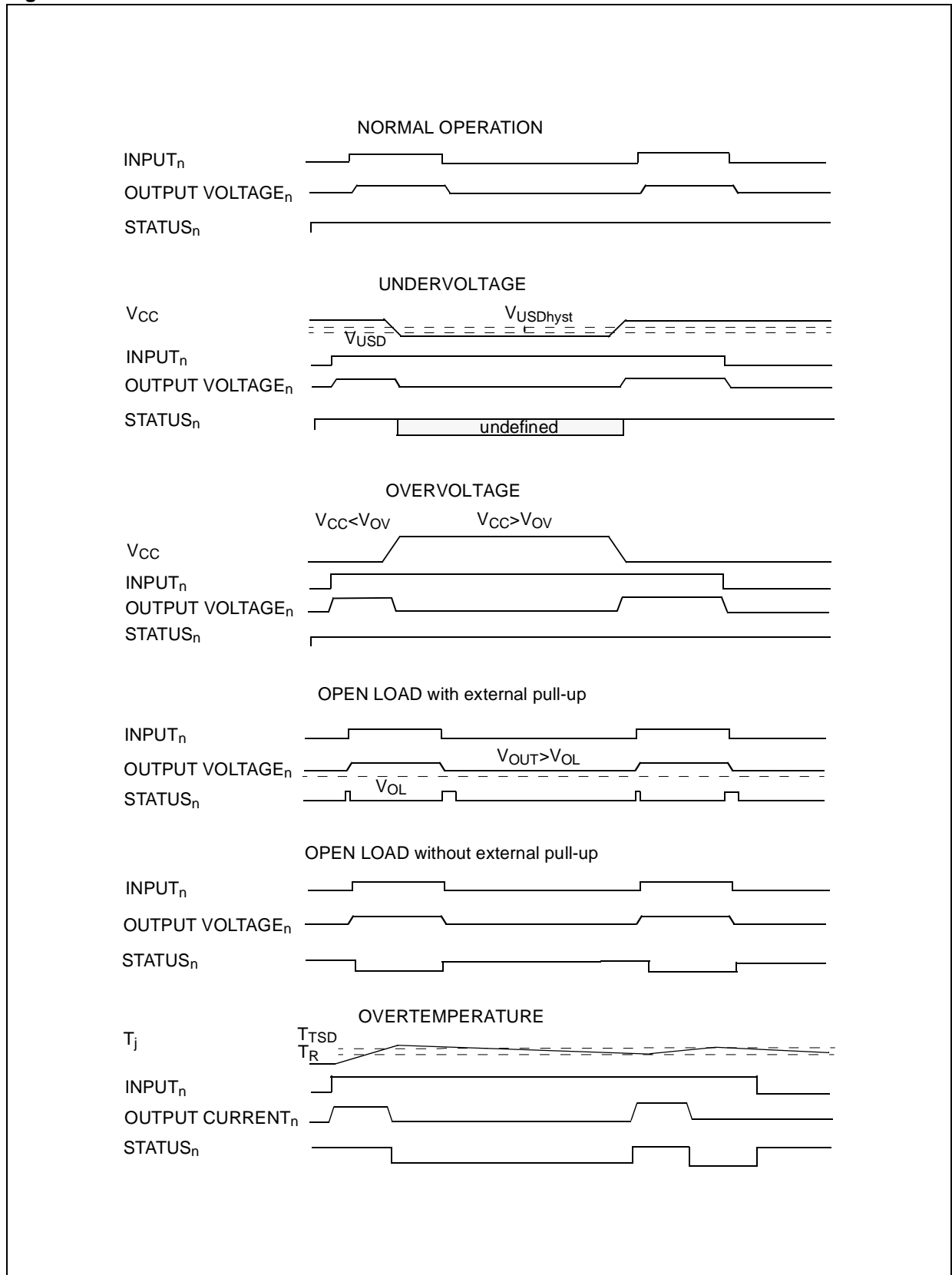

Figure 7. Waveforms



Electrical Characterization For Dual High Side Switch

Figure 8. Off State Output Current

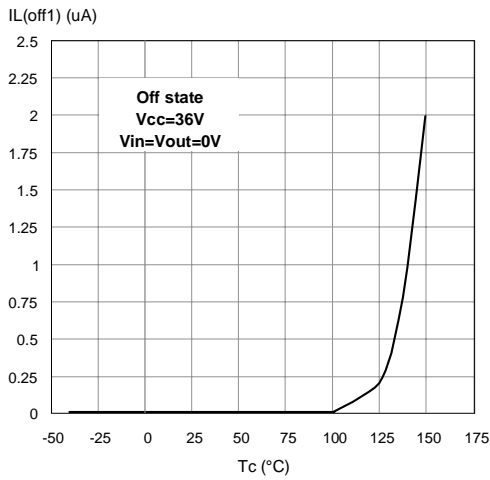

Figure 11. Input Clamp Voltage

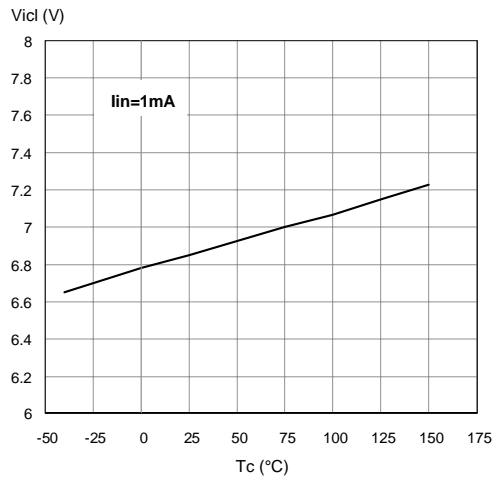

Figure 9. High Level Input Current

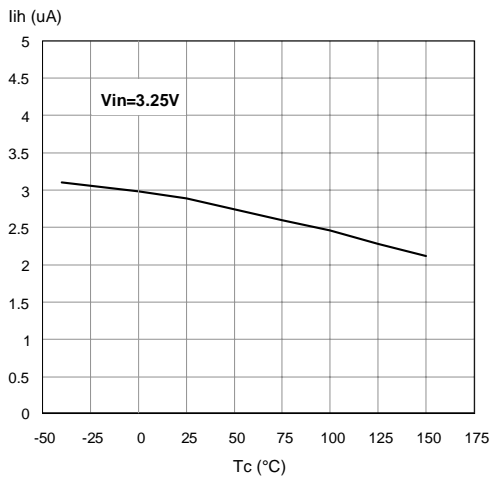

Figure 12. Input High Level

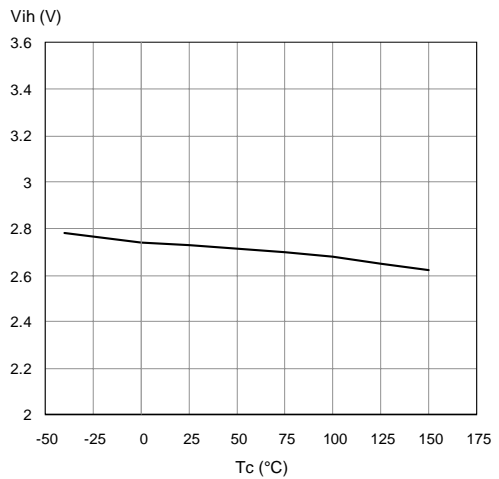

Figure 10. Input Low Level

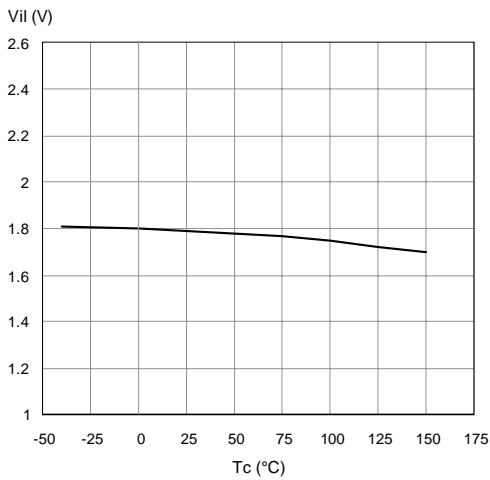
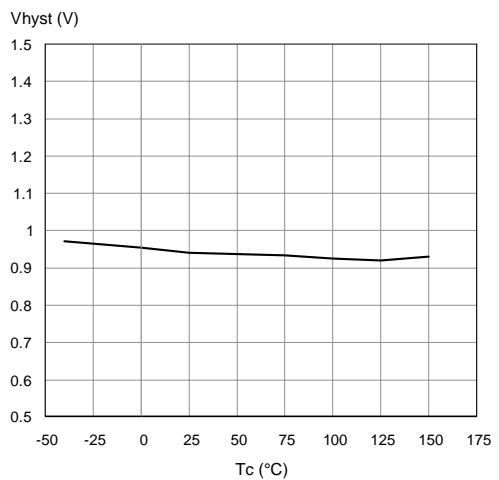

Figure 13. Input Hysteresis Voltage



Electrical Characterization For Dual High Side Switch (continued)

Figure 14. Overvoltage Shutdown

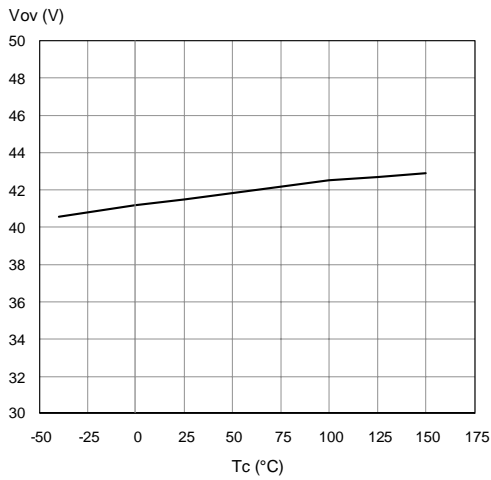

Figure 17. I_{LIM} Vs T_{case}

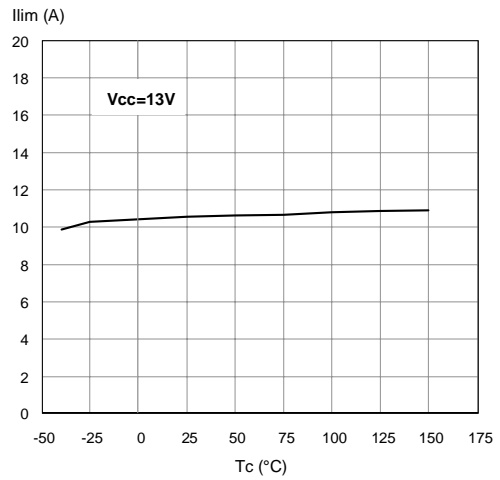

Figure 15. Turn-on Voltage Slope

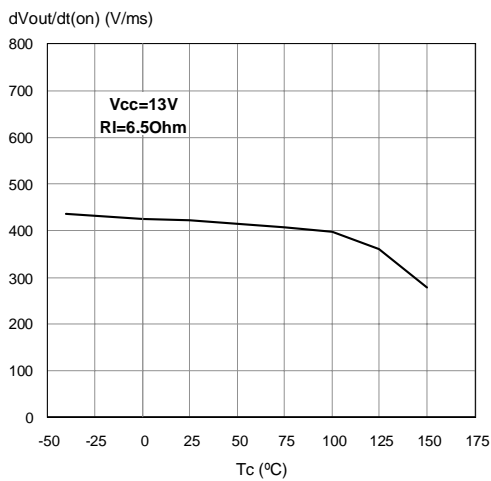

Figure 18. Turn-off Voltage Slope

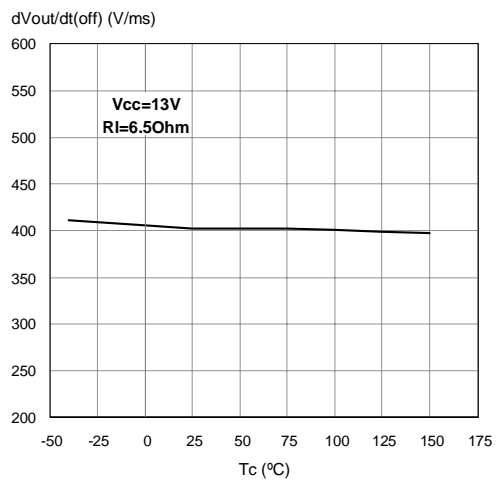

Figure 16. On State Resistance Vs T_{case}

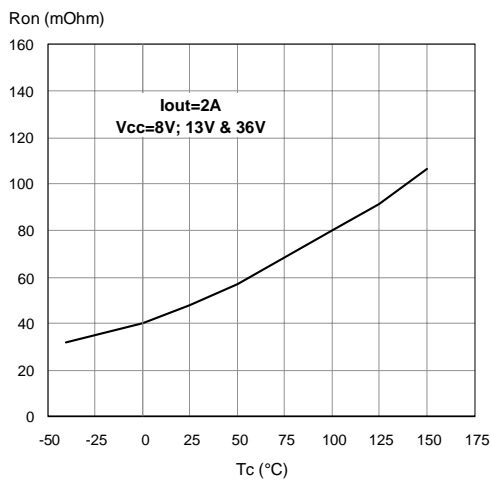
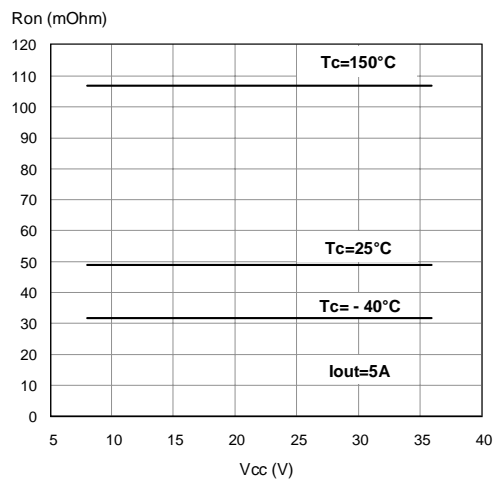

Figure 19. On State Resistance Vs V_{CC}



Electrical Characterization For Dual High Side Switch (continued)

Figure 20. Status Leakage Current

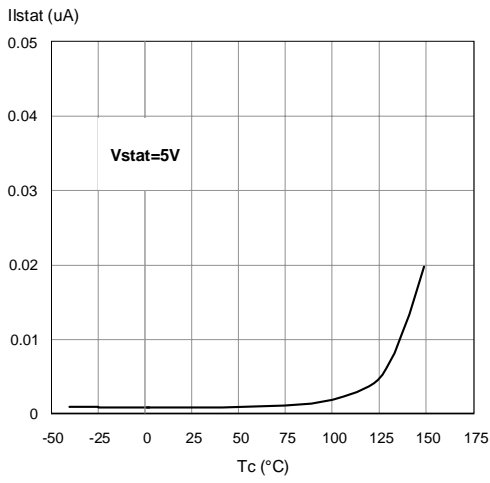

Figure 23. Status Low Output Voltage

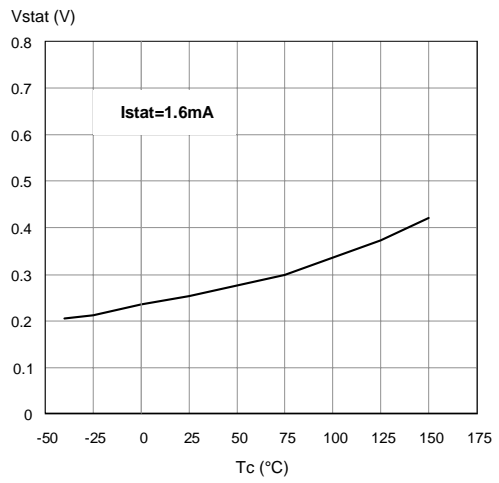

Figure 21. Openload On State Detection Threshold

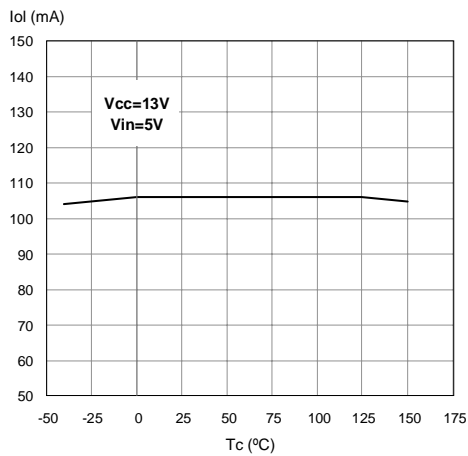

Figure 24. Openload Off State Voltage Detection Threshold

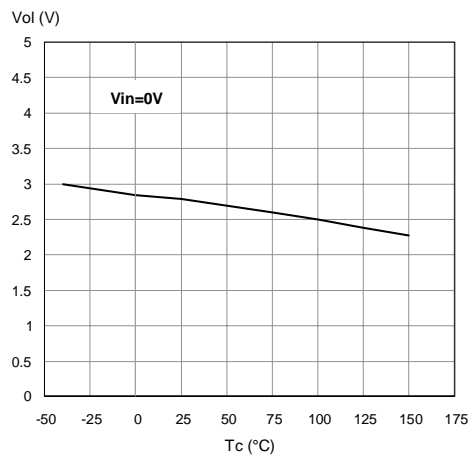
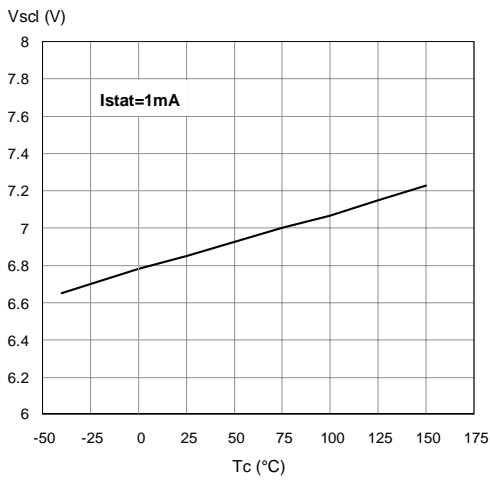

Figure 22. Status Clamp Voltage



Electrical Characterization For Low Side Switches

Figure 25. Static Drain Source On Resistance

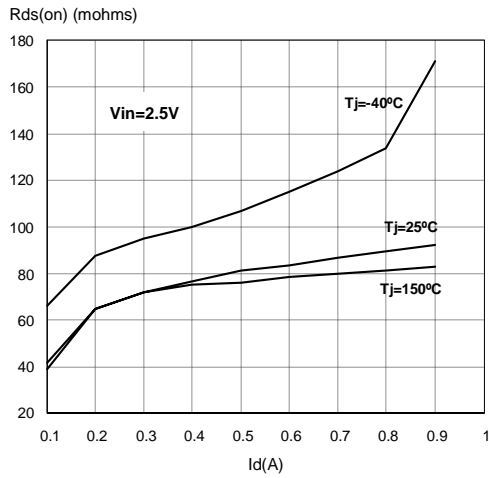

Figure 28. Derating Curve

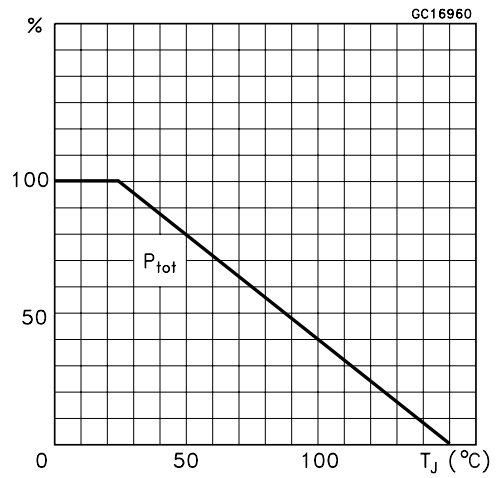

Figure 26. Transconductance

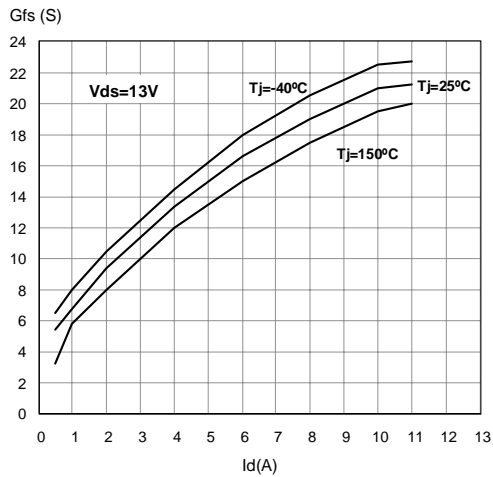

Figure 29. Transfer Characteristics

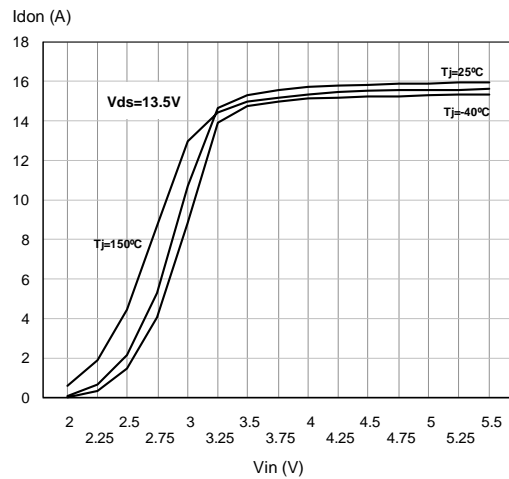

Figure 27. Turn On Current Slope

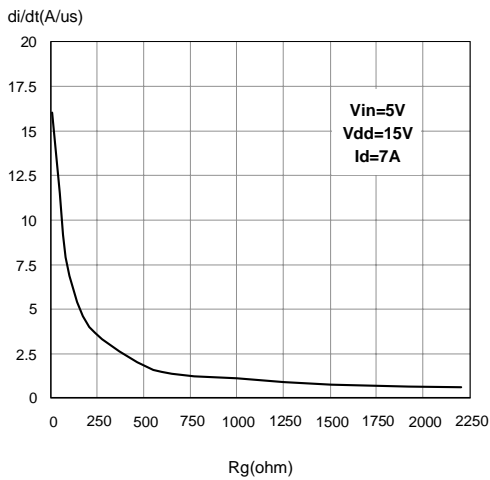
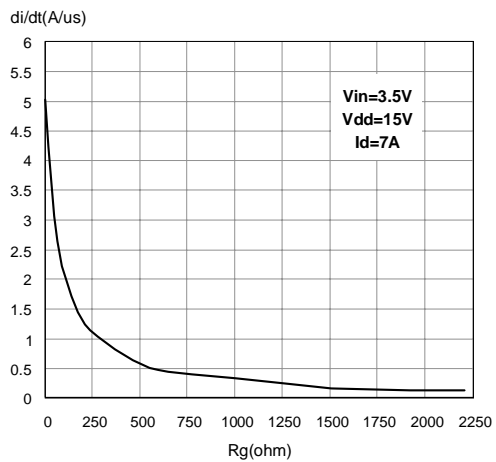

Figure 30. Turn On Current Slope



Electrical Characterization For Low Side Switches (continued)

Figure 31. Input Voltage Vs. Input Charge

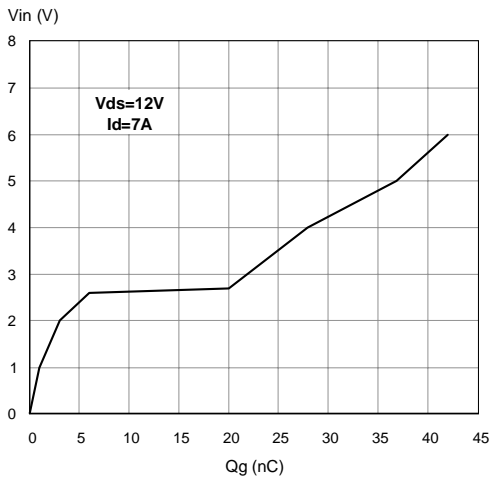

Figure 34. Capacitance Variations

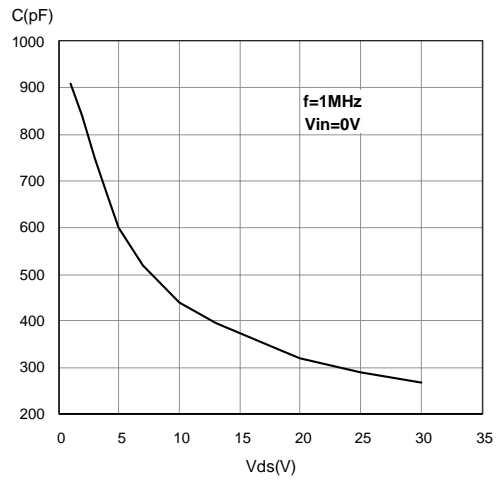

Figure 32. Switching Time Resistive Load

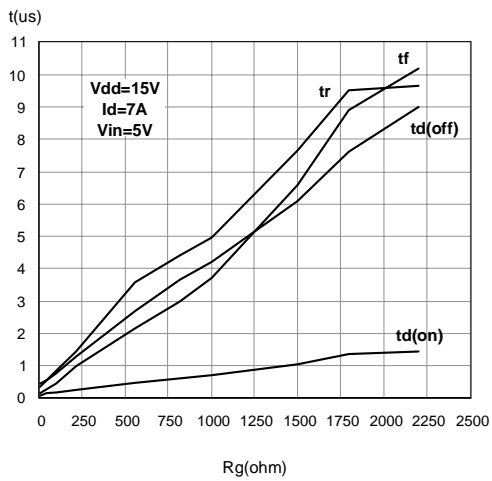

Figure 35. Switching Time Resistive Load

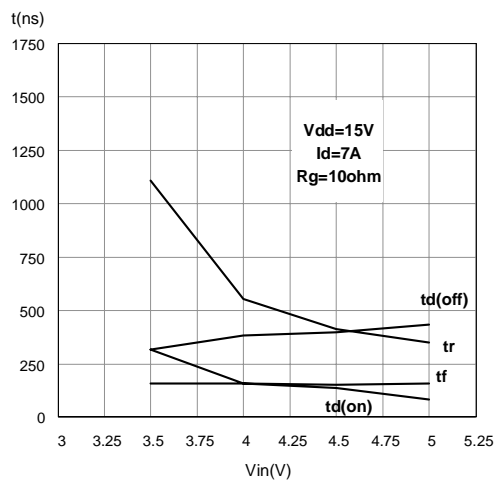

Figure 33. Output Characteristics

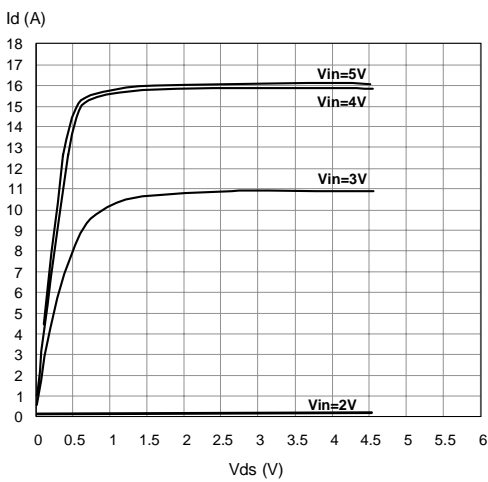
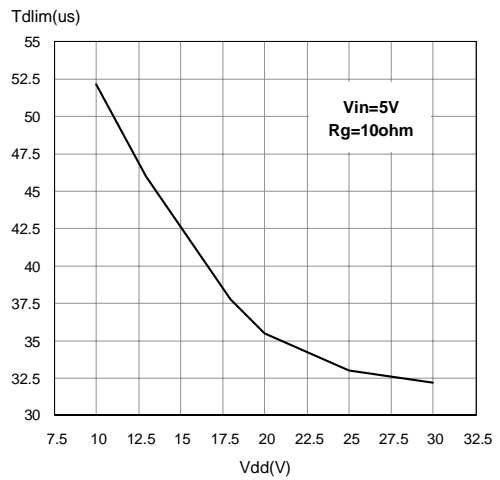

Figure 36. Step Response Current Limit



Electrical Characterization For Low Side Switches (continued)

Figure 37. Source-Drain Diode Forward Characteristics

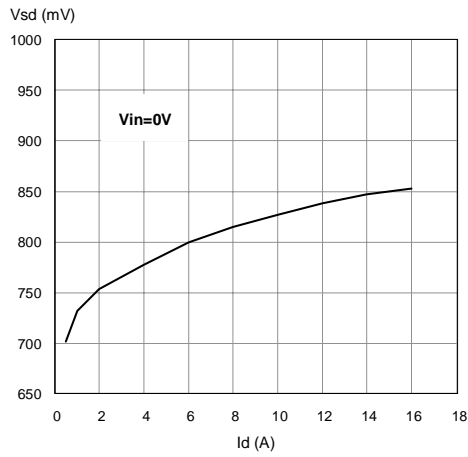

Figure 40. Static Drain-Source On Resistance Vs. Id

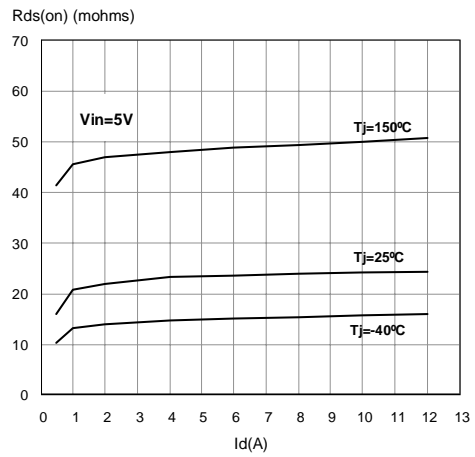

Figure 38. Static Drain-Source On resistance Vs. Input Voltage

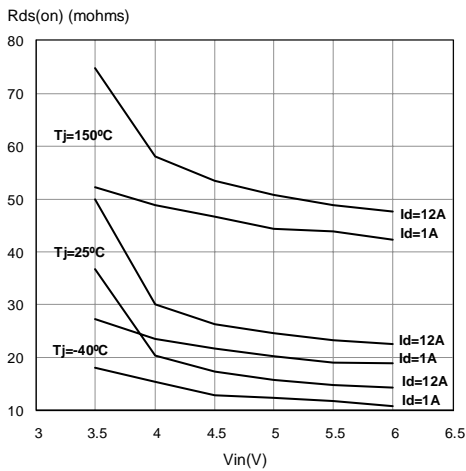

Figure 41. Static Drain-Source On resistance Vs. Input Voltage

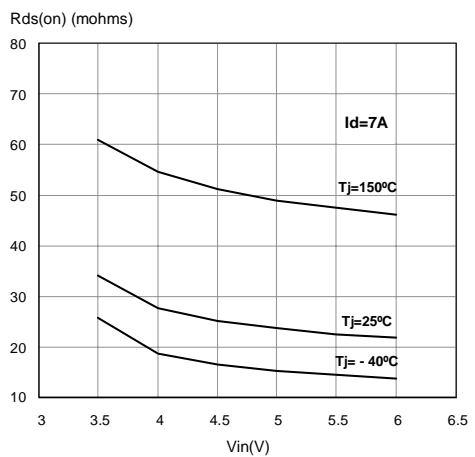

Figure 39. Normalized Input Threshold Voltage Vs. Temperature

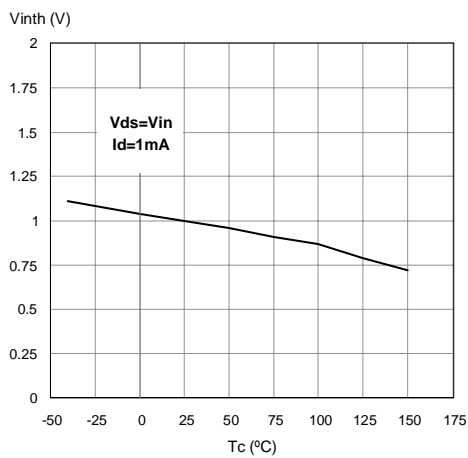
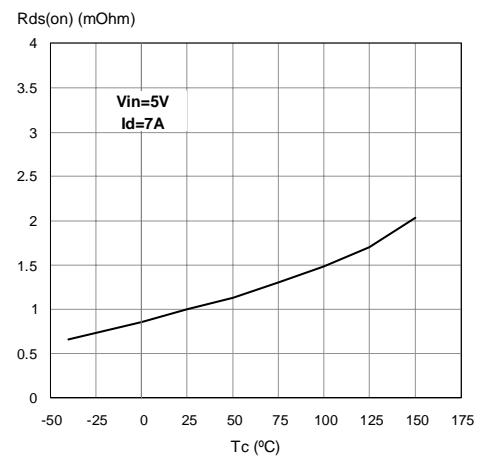

Figure 42. Normalized On Resistance Vs. Temperature



Electrical Characterization For Low Side Switches (continued)

Figure 43. Turn off drain source voltage slope

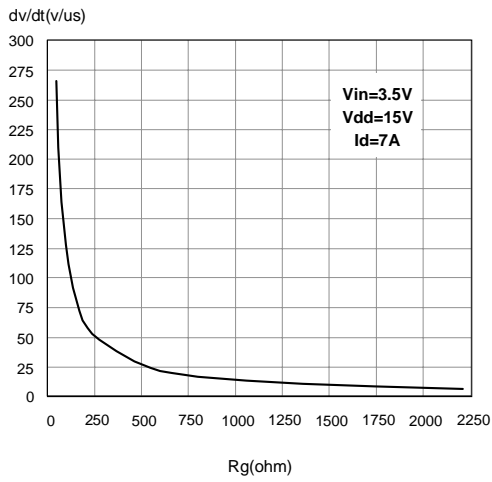

Figure 45. Turn off drain source voltage slope

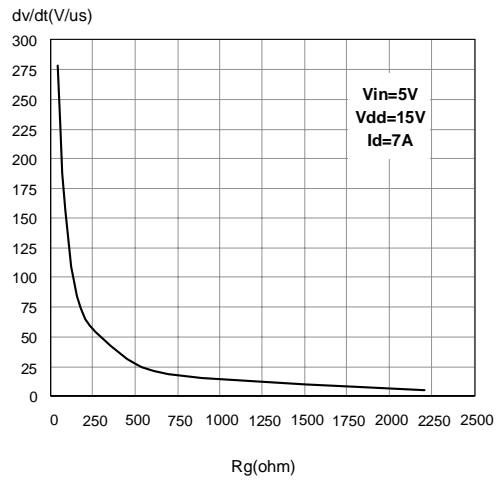

Figure 44. Current Limit Vs. Junction Temperature

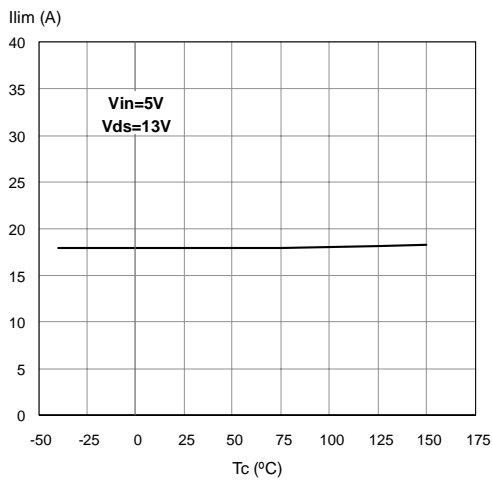

Table 20. SO-28 Mechanical Data

Symbol	millimeters		
	Min	Typ	Max
A			2.65
a1	0.10		0.30
b	0.35		0.49
b1	0.23		0.32
C		0.50	
c1		45° (typ.)	
D	17.7		18.1
E	10.00		10.65
e		1.27	
e3		16.51	
F	7.40		7.60
L	0.40		1.27
S		8° (max.)	

Figure 46. SO-28 Package Dimensions

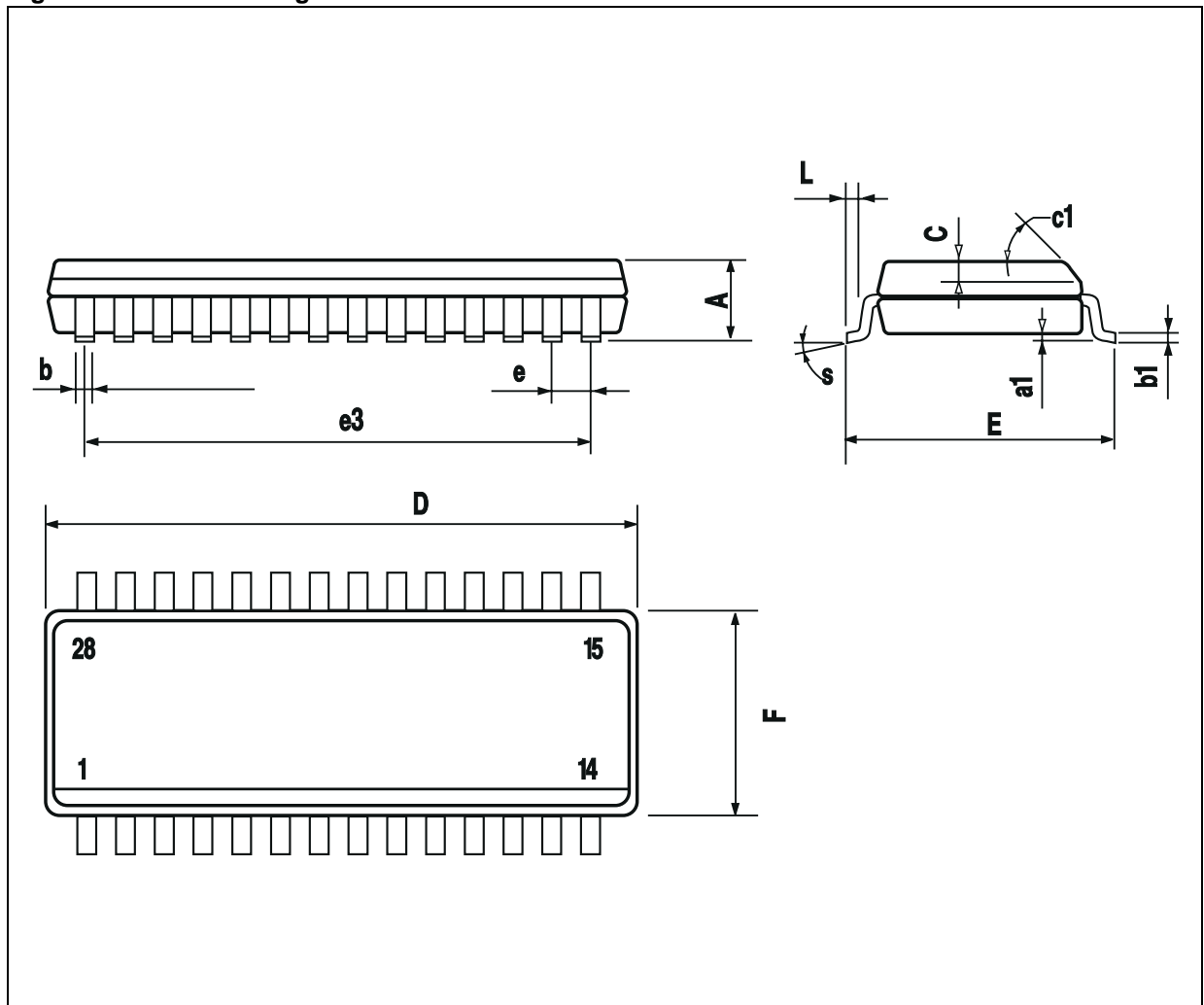

Figure 47. SO-28 Tube Shipment (No Suffix)

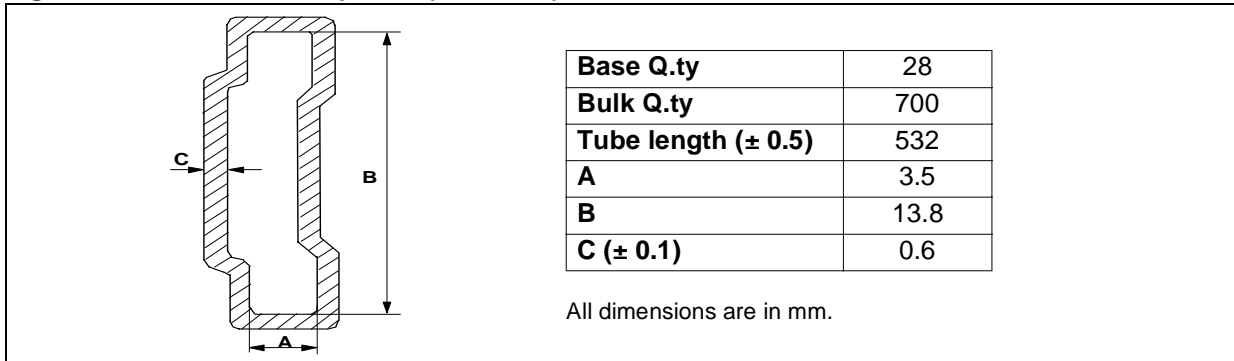
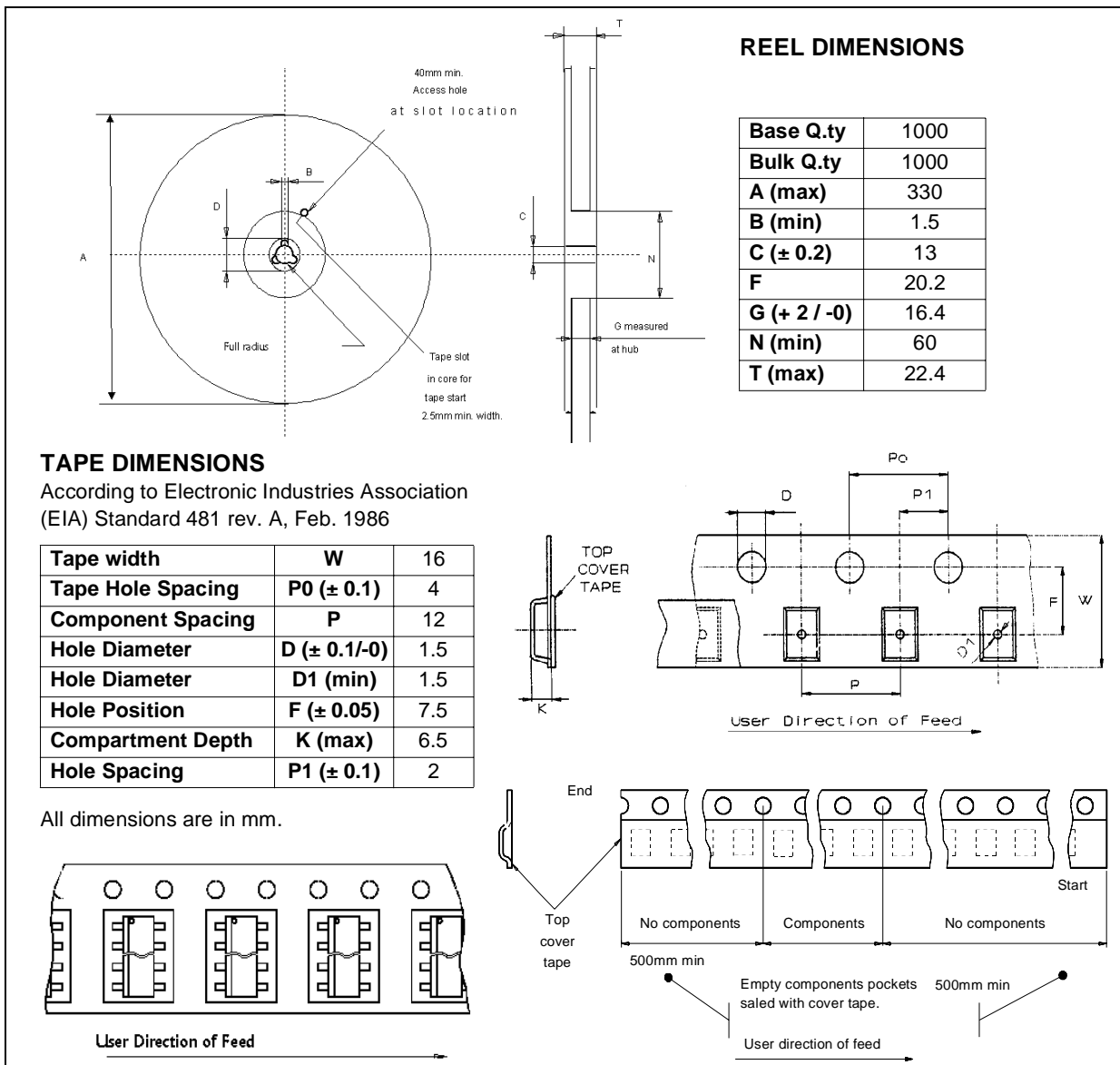

Figure 48. Tape And Reel Shipment (Suffix "TR")



REVISION HISTORY

Date	Revision	Description of Changes
Sep. 2004	1	- First Issue.

Information furnished is believed to be accurate and reliable. However, STMicroelectronics assumes no responsibility for the consequences of use of such information nor for any infringement of patents or other rights of third parties which may result from its use. No license is granted by implication or otherwise under any patent or patent rights of STMicroelectronics. Specifications mentioned in this publication are subject to change without notice. This publication supersedes and replaces all information previously supplied. STMicroelectronics products are not authorized for use as critical components in life support devices or systems without express written approval of STMicroelectronics.

The ST logo is a registered trademark of STMicroelectronics.
All other names are the property of their respective owners

© 2004 STMicroelectronics - All rights reserved

STMicroelectronics group of companies

Australia - Belgium - Brazil - Canada - China - Czech Republic - Finland - France - Germany - Hong Kong - India - Israel - Italy - Japan -
Malaysia - Malta - Morocco - Singapore - Spain - Sweden - Switzerland - United Kingdom - United States of America

www.st.com