

# USR UNR 2-T220 / T220B / T221

## USS UNS 2-T220

Precision Foil Resistors

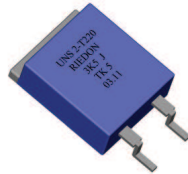

- Resistances from 0.5Ohm to 150kOhms
- Power Rating to 10Watt
- Resistance Tolerances to  $\pm 0.01\%$
- TCR to  $\pm 3\text{ppm/K}$
- Load Stability to 0.01%
- TO-220 Housing
- Convenient SMD D2Pak Available



### SPECIFICATIONS

Type	USR / USS	UNR / UNS
Resistance Range	0.5 Ohms to 150 kOhms	0.5 Ohms to 5 kOhms
Power rating free air 70°C (R<50R0) free air 70°C (R>50R0) with heatsink (R<50R0) with heatsink (R>50R0)	1.5W 1.0W 10W 6W	1.5W 1.0W 15W 10W
Thermal Resistance Rthj-c R<50R0 R>50R0	10.8 K/W 18.8 K/W	6.8 K/W 10.8 K/W
Tolerances from 0.5 Ohms from 10.0 Ohms from 25.0 Ohms from 50.0 Ohms	0.1% / 0.25% / 0.5% / 1% 0.05% / 0.1% / 0.25% / 0.5% / 1% 0.02% / 0.05% / 0.1% / 0.25% / 0.5% / 1% 0.01% / 0.02% / 0.05% / 0.1% / 0.25% / 0.5% / 1%	
Stability	0.01%	
Shelf Life Stability	25ppm / $\Delta R$ after 1 year 50ppm / $\Delta R$ after 3 year	
Temperature Coefficient	max. $\pm 5\text{ppm/K}$ (-55 to 155°C) typ. $\pm 3\text{ppm/K}$ (-55 to 125°C)	
Voltage Proof	1 kVDC	
Thermal EMF	< 0.1 $\mu\text{V/K}$	
Operating Temperature Range	-55 to 155°C	
Resistor Material	NiCr-Foil	
Substrate	Al <sub>2</sub> O <sub>3</sub>	AlN
Housing	Epoxy + Cu heatsink nickel plated	
Connector Material	Cu tinned	
Terminals	2	
Soldering Temperature	210°C <30 seconds other versions upon request	
Max. Torque	1.0 Nm	
Notes	Specially designed for applications with fast changing electrical load	

### Ordering Information

Part Description: Part Type - Resistance - Contact - Tolerance - TCR

Example: UNR 2-T220B 5.7kOhms C 0.5% 3ppm

**SPECIFICATIONS** (continued)

**Temperature Coefficient**

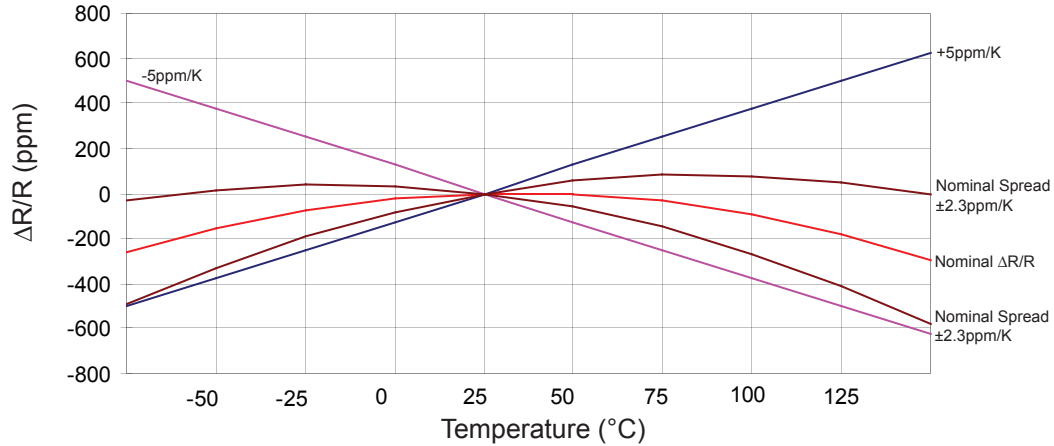

**Derating**

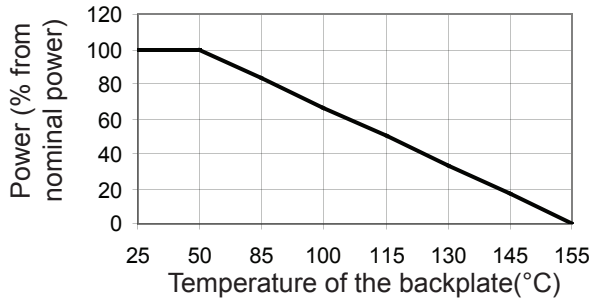

**Power Rating Notes -**

The U-Series Resistors must be attached to a suitable heatsink. The maximum internal resistor temperature is 155°C. To specify an appropriate heatsink use the following formula :

$$R_{0H} = \frac{T_{MAX} - (P \times R_{0R}) - T_A}{P}$$

Where:  $R_{0H}$  = Thermal Resistance of Heatsink ( K/W )  
 $R_{0R}$  = Thermal Resistance of Resistor ( K/W )  
 $T_{MAX}$  = Maximum Temperature of Resistor  
 $T_A$  = Ambient Temperature of Heatsink ( °C )  
 $P$  = Power Through Resistor ( W )

**Dimensions**

**USS 2-T220 / UNS 2-T220**

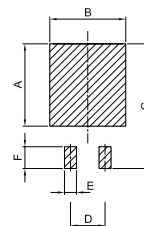
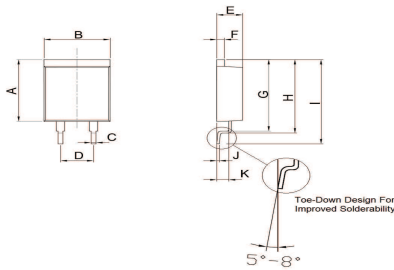

Dimension	mm	tol. (±mm)	inches	tol. (±inches)
A	12.70	0.2	0.50	0.008
B	10.16	0.2	0.40	0.008
C	0.76	0.1	0.03	0.004
D	5.08	0.1	0.20	0.004
E	4.00	0.1	0.16	0.004
F	1.20	0.1	0.05	0.004
G	14.60	0.2	0.57	0.008
H	15.00	0.2	0.59	0.008
I	17.33	0.2	0.68	0.008
J	0.40	0.1	0.02	0.004
K	1.85	0.1	0.07	0.004

Dimension	mm	inches
A	12.10	0.476
B	11.16	0.439
C	18.33	0.722
D	5.08	0.200
E	1.76	0.069
F	3.20	0.126

**SPECIFICATIONS** (continued)

Dimensions

USR 2-T220B / UNR 2-T220B

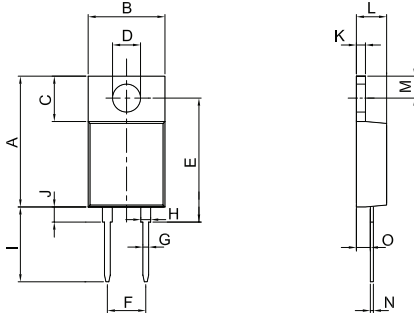

Dimension	mm	tol. (±mm)	inches	tol. (±inches)
A	17.30	0.2	0.68	0.008
B	10.16	0.2	0.40	0.008
C	6.00	0.1	0.24	0.004
D	Ø3.7	0.1	Ø0.146	0.004
E	16.40	0.2	0.65	0.008
F	5.08	0.1	0.20	0.004
G	0.76	0.1	0.03	0.004
H	1.30	0.1	0.05	0.004
I	10.00	0.2	0.39	0.008
I (C-Contact)	13.80	0.2	0.54	0.008
J	2.00	0.1	0.08	0.004
K	1.20	0.1	0.05	0.004
L	4.00	0.1	0.16	0.004
M	2.90	0.1	0.11	0.004
N	0.40	0.1	0.02	0.004
O	1.85	0.1	0.07	0.004

USR 2-T221 / UNR 2-T221

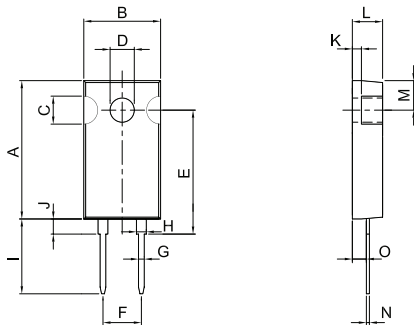

Dimension	mm	tol. (±mm)	inches	tol. (±inches)
A	18.30	0.2	0.72	0.008
B	10.16	0.2	0.40	0.008
C	3.70	0.1	0.15	0.004
D	Ø3.2	0.1	Ø0.126	0.004
E	16.40	0.2	0.65	0.008
F	5.08	0.1	0.20	0.004
G	0.76	0.1	0.03	0.004
H	1.30	0.1	0.05	0.004
I	10.00	0.2	0.39	0.008
I (C-Contact)	13.80	0.2	0.54	0.008
J	2.00	0.1	0.08	0.004
K	1.20	0.1	0.05	0.004
L	4.00	0.1	0.16	0.004
M	3.90	0.1	0.15	0.004
N	0.40	0.1	0.02	0.004
O	1.85	0.1	0.07	0.004

USR 2-T220 / UNR 2-T220

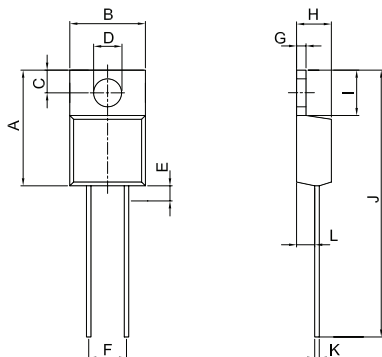

Dimension	mm	tol. (±mm)	inches	tol. (±inches)
A	15.30	0.2	0.60	0.008
B	10.00	0.2	0.39	0.008
C	2.80	0.1	0.11	0.004
D	Ø3.7	0.1	Ø0.146	0.004
E	2.00	0.1	0.08	0.004
F	5.08	0.1	0.20	0.004
G	1.27	0.1	0.05	0.004
H	4.60	0.1	0.18	0.004
I	6.00	0.2	0.24	0.008
J	35.30	2.0	1.39	0.079
K	Ø0.6	0.1	Ø0.02	0.004
L	2.41	0.1	0.09	0.004