

## ST SERIES - MINIATURE ROCKER & LEVER SWITCHES

B

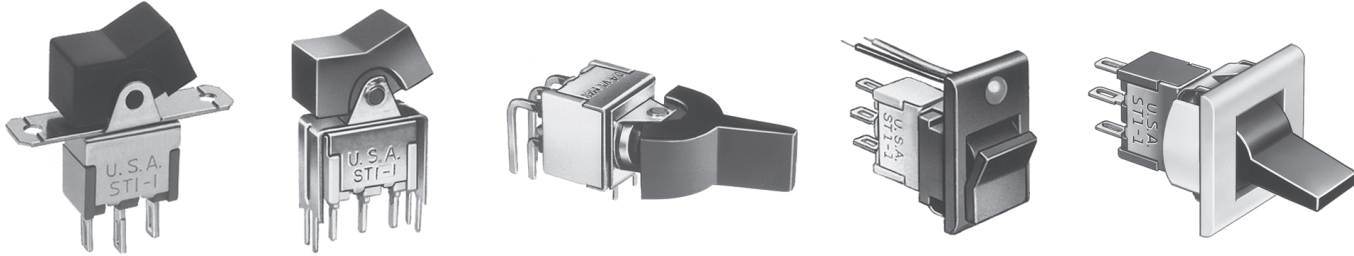

### FEATURES

- Dry circuit through power ratings .
- Ultra-rugged construction SPDT & DPDT models with numerous options.
- Panel, panel & p.c. and p.c. mounting models, lighted and unlighted.

### SPECIFICATIONS

<b>Contact ratings (resistive loads):</b>	(Q) power models - coin silver: 6 Amps at 125 VAC, 3 Amps at 250 VAC or 7 Amps at 30 VDC. (B) dry circuit models - gold over nickel over brass: 0.4 VA max. at 20 V max. UL models - coin silver: 6 Amps at 125 VAC or 3 Amps at 250 VAC (75% power factor). UL file no. E66367. CSA models - coin silver: same ratings as UL models. CSA file no. LR54592-1.
<b>Initial contact resistance:</b>	3 milliohms max. at 3 VDC, 0.1 Amp.
<b>Insulation resistance:</b>	Greater than 200,000 megohms between terminals & case ground.
<b>Dielectric strength:</b>	Greater than 2000 VAC for 1 minute between terminals & case ground.
<b>Electrical life (resistive loads):</b>	100,000 cycles min. for ST1-1 & ST2-1. Other models, 40,000 cycles min.
<b>Operating temperature range:</b>	-30°C to +85°C

### MATERIALS

<b>Contacts:</b>	Coin silver for power, UL & CSA models. Gold over nickel over brass for dry circuit models.
<b>Actuator:</b>	J1 & J2 - Glass filled polyester. J3 & J4 - Nylon or acetal
<b>Bushing:</b>	Nickel plated brass
<b>Strap:</b>	Stainless steel
<b>Case:</b>	Melamine phenolic, color red
<b>Terminal seal:</b>	Epoxy (optional)
<b>Support bracket:</b>	Brass or steel, tin plated
<b>Spring mounting bracket:</b>	Stainless steel
<b>Bezel:</b>	Nylon. Available in black, red & white. Consult factory for other colors.
<b>Hardware:</b>	See 'Miscellaneous' section.
<b>LED:</b>	Intensity: 2.0 mcd at 10 mA. Forward voltage: 2.0V (3.0V max.). Max. continuous forward current: 15 mA for red, 30 mA for green & 20 mA for yellow. Red is standard. Yellow & green are optional. Specifications are subject to change without notice - consult factory.

### AGENCY RECOGNITION



UL, & CSA. Marking: Switches ordered by UL model number are supplied with recognition marking. Switches ordered by UL model no. and with '/CSA' added at end of model no. are supplied with both recognized marks.

### ABOUT THIS SERIES

The material in this series is organized in the following sequence:

- Completely specified switch models
- Miscellaneous
- 'build your own switch' order format
- Option drawings & information
- Mounting information and panel cut-outs

SPECIFICATIONS SUBJECT TO CHANGE WITHOUT NOTICE

# ST SERIES - MINIATURE ROCKER & LEVER SWITCHES

## Solder lug terminals - panel mounting

**SINGLE POLE WITH J1 ROCKER**

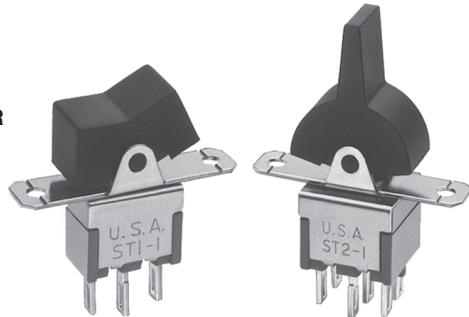

**DOUBLE POLE WITH J2 LEVER**

	POWER CKT. MODEL NO.	UL MODEL NO.	USA marking on other side		
Single pole	ST1-1L4S4ZQJ12	UL11L4S4ZQJ12	ON	NONE	ON
	ST1-2L4S4ZQJ12	UL12L4S4ZQJ12	ON	OFF	ON
	ST1-3L4S4ZQJ12	UL13L4S4ZQJ12	MOM	OFF	MOM
	ST1-4L4S4ZQJ12	UL14L4S4ZQJ12	ON	OFF	MOM
	ST1-5L4S4ZQJ12	UL15L4S4ZQJ12	ON	NONE	MOM
Double pole	ST2-1L4S4ZQJ12	UL21L4S4ZQJ12	ON	NONE	ON
	ST2-2L4S4ZQJ12	UL22L4S4ZQJ12	ON	OFF	ON
	ST2-3L4S4ZQJ12	UL23L4S4ZQJ12	MOM	OFF	MOM
	ST2-4L4S4ZQJ12	UL24L4S4ZQJ12	ON	OFF	MOM
	ST2-5L4S4ZQJ12	UL25L4S4ZQJ12	ON	NONE	MOM
	ST2-6L4S4ZQJ12	UL26L4S4ZQJ12	ON	ON	ON
	ST2-7L4S4ZQJ12	UL27L4S4ZQJ12	ON	ON	MOM
	ST2-8L4S4ZQJ12	UL28L4S4ZQJ12	MOM	ON	MOM
Terminals connected (-6, -7 & -8)			1-2, 4-5	1-2, 5-6	2-3, 5-6

Above models have black actuator.

SPECIFICATIONS SUBJECT TO CHANGE WITHOUT NOTICE

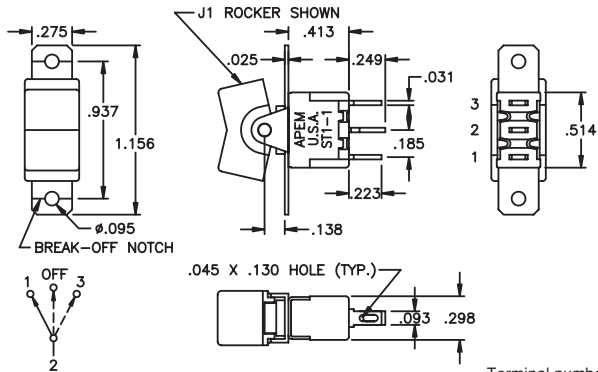

**SINGLE POLE**

Terminal numbers for reference only

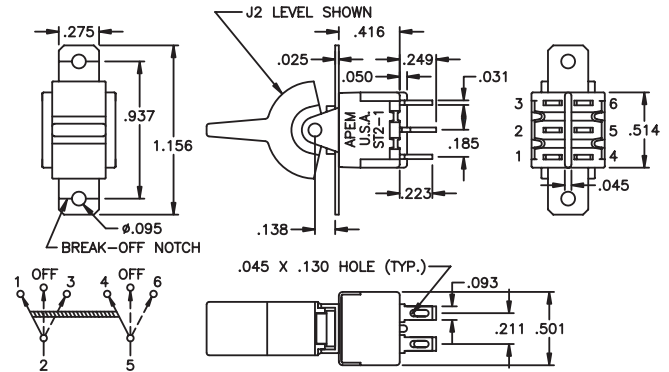

**DOUBLE POLE**

## Straight p.c. terminals with bracket - p.c. mounting

**SINGLE POLE WITH J1 ROCKER**

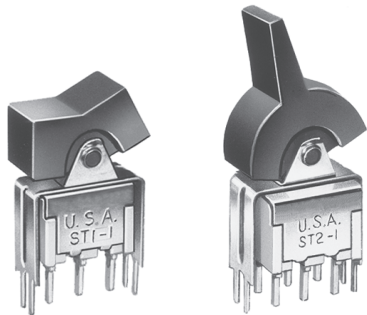

**DOUBLE POLE WITH J2 LEVER**

	DRY CKT. MODEL NO.	UL MODEL NO.	USA marking on other side		
Single pole	ST1-1L4S4V30BJ12	UL11L4S4V30QJ12	ON	NONE	ON
	ST1-2L4S4V30BJ12	UL12L4S4V30QJ12	ON	OFF	ON
	ST1-3L4S4V30BJ12	UL13L4S4V30QJ12	MOM	OFF	MOM
	ST1-4L4S4V30BJ12	UL14L4S4V30QJ12	ON	OFF	MOM
	ST1-5L4S4V30BJ12	UL15L4S4V30QJ12	ON	NONE	MOM
Double pole	ST2-1L4S4V30BJ12	UL21L4S4V30QJ12	ON	NONE	ON
	ST2-2L4S4V30BJ12	UL22L4S4V30QJ12	ON	OFF	ON
	ST2-3L4S4V30BJ12	UL23L4S4V30QJ12	MOM	OFF	MOM
	ST2-4L4S4V30BJ12	UL24L4S4V30QJ12	ON	OFF	MOM
	ST2-5L4S4V30BJ12	UL25L4S4V30QJ12	ON	NONE	MOM
	ST2-6L4S4V30BJ12	UL26L4S4V30QJ12	ON	ON	ON
	ST2-7L4S4V30BJ12	UL27L4S4V30QJ12	ON	ON	MOM
	ST2-8L4S4V30BJ12	UL28L4S4V30QJ12	MOM	ON	MOM
Terminals connected (-6, -7 & -8)			1-2, 4-5	1-2, 5-6	2-3, 5-6

Above models have black actuator.

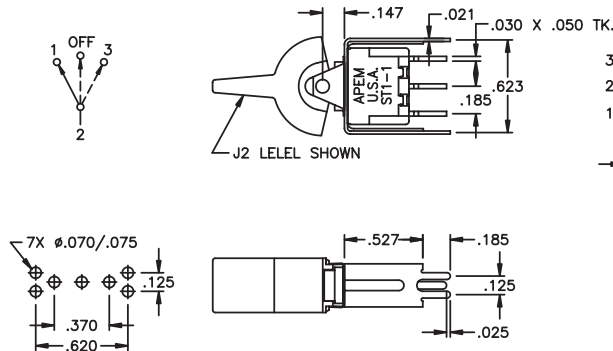

**SINGLE POLE**

Terminal numbers for reference only

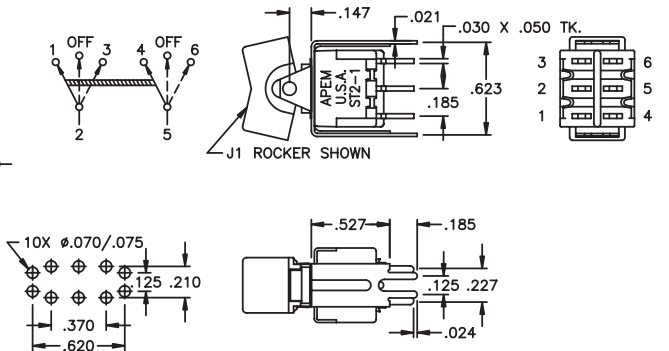

**DOUBLE POLE**

# ST SERIES - MINIATURE ROCKER & LEVER SWITCHES

**B**

## Horizontal right angle p.c. terminals - p.c. mounting

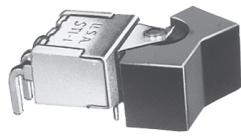

**SINGLE POLE WITH J1 ROCKER**

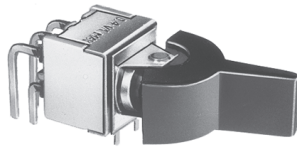

**DOUBLE POLE WITH J2 LEVER**

	DRY CKT. MODEL NO.	UL MODEL NO.	USA marking on other side		
Single pole	ST1-1L4S4A-1BJ12	UL11L4S4A-1QJ12	ON	NONE	ON
	ST1-2L4S4A-1BJ12	UL12L4S4A-1QJ12	ON	OFF	ON
	ST1-3L4S4A-1BJ12	UL13L4S4A-1QJ12	MOM	OFF	MOM
	ST1-4L4S4A-1BJ12	UL14L4S4A-1QJ12	ON	OFF	MOM
	ST1-5L4S4A-1BJ12	UL15L4S4A-1QJ12	ON	NONE	MOM
Double pole	ST2-1L4S4A-1BJ12	UL21L4S4A-1QJ12	ON	NONE	ON
	ST2-2L4S4A-1BJ12	UL22L4S4A-1QJ12	ON	OFF	ON
	ST2-3L4S4A-1BJ12	UL23L4S4A-1QJ12	MOM	OFF	MOM
	ST2-4L4S4A-1BJ12	UL24L4S4A-1QJ12	ON	OFF	MOM
	ST2-5L4S4A-1BJ12	UL25L4S4A-1QJ12	ON	NONE	MOM
	ST2-6L4S4A-1BJ12	UL26L4S4A-1QJ12	ON	ON	ON
	ST2-7L4S4A-1BJ12	UL27L4S4A-1QJ12	ON	ON	MOM
	ST2-8L4S4A-1BJ12	UL28L4S4A-1QJ12	MOM	ON	MOM
Terminals connected (-6, -7 & -8)			1-2, 4-5	1-2, 5-6	2-3, 5-6

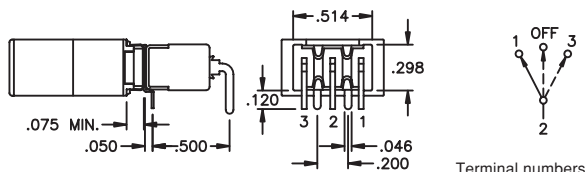
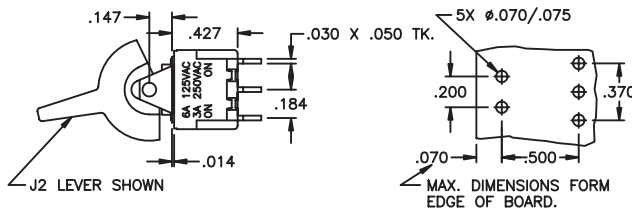

**SINGLE POLE**

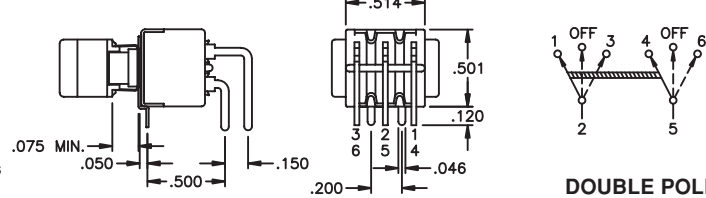
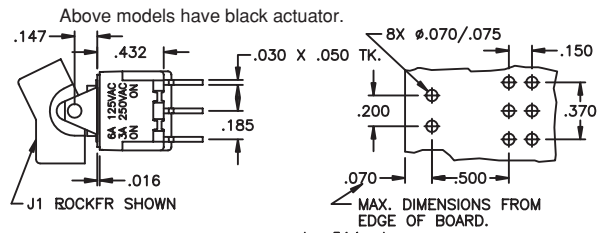

**DOUBLE POLE**

## Vertical right angle p.c. terminals - p.c. mounting

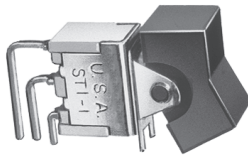

**SINGLE POLE WITH J1 ROCKER**

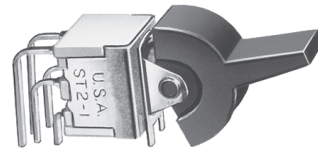

**DOUBLE POLE WITH J2 LEVER**

	DRY CKT. MODEL NO.	UL MODEL NO.	USA marking on other side		
Single pole	ST1-1L4S4V-1BJ12	UL11L4S4V-1QJ12	ON	NONE	ON
	ST1-2L4S4V-1BJ12	UL12L4S4V-1QJ12	ON	OFF	ON
	ST1-3L4S4V-1BJ12	UL13L4S4V-1QJ12	MOM	OFF	MOM
	ST1-4L4S4V-1BJ12	UL14L4S4V-1QJ12	ON	OFF	MOM
	ST1-5L4S4V-1BJ12	UL15L4S4V-1QJ12	ON	NONE	MOM
Double pole	ST2-1L4S4V-1BJ12	UL21L4S4V-1QJ12	ON	NONE	ON
	ST2-2L4S4V-1BJ12	UL22L4S4V-1QJ12	ON	OFF	ON
	ST2-3L4S4V-1BJ12	UL23L4S4V-1QJ12	MOM	OFF	MOM
	ST2-4L4S4V-1BJ12	UL24L4S4V-1QJ12	ON	OFF	MOM
	ST2-5L4S4V-1BJ12	UL25L4S4V-1QJ12	ON	NONE	MOM
	ST2-6L4S4V-1BJ12	UL26L4S4V-1QJ12	ON	ON	ON
	ST2-7L4S4V-1BJ12	UL27L4S4V-1QJ12	ON	ON	MOM
	ST2-8L4S4V-1BJ12	UL28L4S4V-1QJ12	MOM	ON	MOM
Terminals connected (-6, -7 & -8)			1-2, 4-5	1-2, 5-6	2-3, 5-6

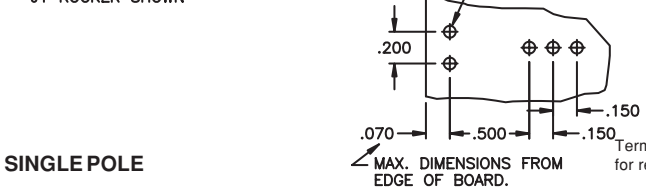
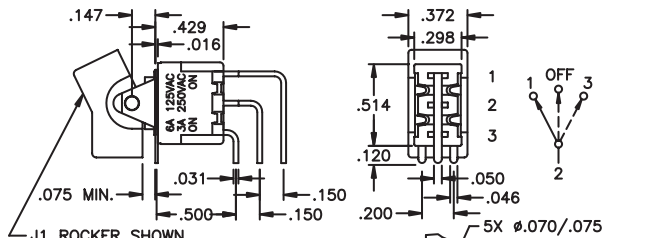

**SINGLE POLE**

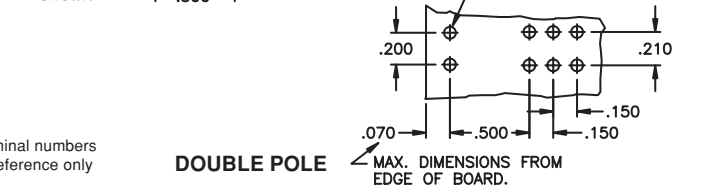
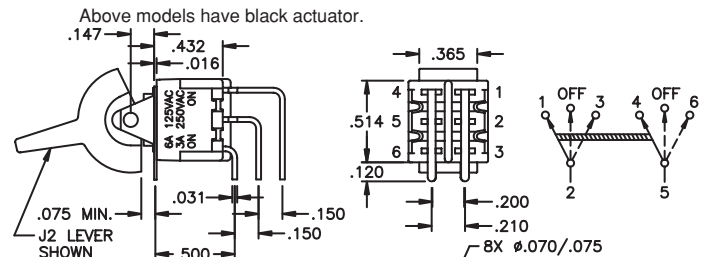

**DOUBLE POLE**

SPECIFICATIONS SUBJECT TO CHANGE WITHOUT NOTICE

# ST SERIES - MINIATURE ROCKER & LEVER SWITCHES

## Solder lug terminals - snap-in bezel with outboard LED

**SINGLE POLE WITH J3 ROCKER**

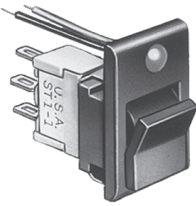

**DOUBLE POLE WITH J4 LEVER**

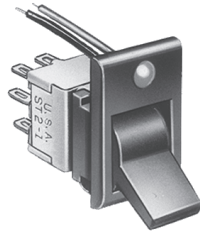

SPECIFICATIONS SUBJECT TO CHANGE WITHOUT NOTICE

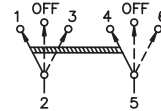
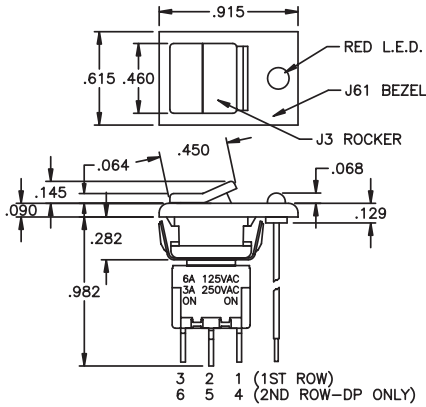

Terminal numbers for reference only

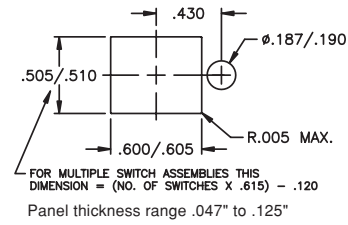

	POWER CKT. MODEL NO.	UL MODEL NO.	USA marking on other side		
Single pole	ST1-1L5S5ZQJ3J6122	UL11L5S5ZQJ3J6122	ON	NONE	ON
	ST1-2L5S5ZQJ3J6122	UL12L5S5ZQJ3J6122	ON	OFF	ON
	ST1-3L5S5ZQJ3J6122	UL13L5S5ZQJ3J6122	MOM	OFF	MOM
	ST1-4L5S5ZQJ3J6122	UL14L5S5ZQJ3J6122	ON	OFF	MOM
	ST1-5L5S5ZQJ3J6122	UL15L5S5ZQJ3J6122	ON	NONE	MOM
Double pole	ST2-1L5S5ZQJ3J6122	UL21L5S5ZQJ3J6122	ON	NONE	ON
	ST2-2L5S5ZQJ3J6122	UL22L5S5ZQJ3J6122	ON	OFF	ON
	ST2-3L5S5ZQJ3J6122	UL23L5S5ZQJ3J6122	MOM	OFF	MOM
	ST2-4L5S5ZQJ3J6122	UL24L5S5ZQJ3J6122	ON	OFF	MOM
	ST2-5L5S5ZQJ3J6122	UL25L5S5ZQJ3J6122	ON	NONE	MOM
	ST2-6L5S5ZQJ3J6122	UL26L5S5ZQJ3J6122	ON	ON	ON
	ST2-7L5S5ZQJ3J6122	UL27L5S5ZQJ3J6122	ON	ON	MOM
	ST2-8L5S5ZQJ3J6122	UL28L5S5ZQJ3J6122	MOM	ON	MOM
Terminals connected (-6, -7 & -8)			1-2, 4-5	1-2, 5-6	2-3, 5-6

Above models have black bezel & actuator.

## Solder lug terminals - snap-in bezel

**SINGLE POLE WITH J3 ROCKER**

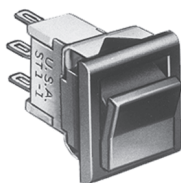

**DOUBLE POLE WITH J4 LEVER**

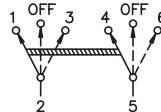
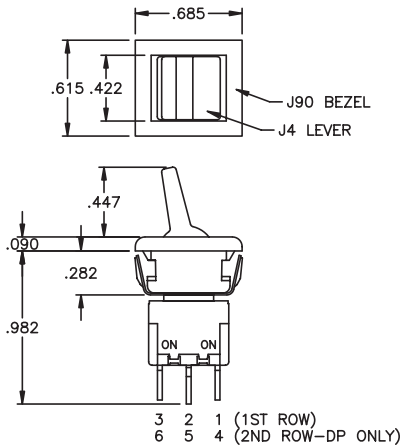
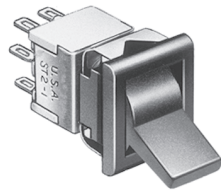

Terminal numbers for reference only

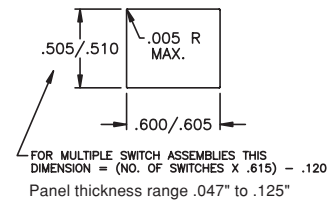

	POWER CKT. MODEL NO.	UL MODEL NO.	USA marking on other side		
Single pole	ST1-1L5S5ZQJ4J9022	UL11L5S5ZQJ4J9022	ON	NONE	ON
	ST1-2L5S5ZQJ4J9022	UL12L5S5ZQJ4J9022	ON	OFF	ON
	ST1-3L5S5ZQJ4J9022	UL13L5S5ZQJ4J9022	MOM	OFF	MOM
	ST1-4L5S5ZQJ4J9022	UL14L5S5ZQJ4J9022	ON	OFF	MOM
	ST1-5L5S5ZQJ4J9022	UL15L5S5ZQJ4J9022	ON	NONE	MOM
Double pole	ST2-1L5S5ZQJ4J9022	UL21L5S5ZQJ4J9022	ON	NONE	ON
	ST2-2L5S5ZQJ4J9022	UL22L5S5ZQJ4J9022	ON	OFF	ON
	ST2-3L5S5ZQJ4J9022	UL23L5S5ZQJ4J9022	MOM	OFF	MOM
	ST2-4L5S5ZQJ4J9022	UL24L5S5ZQJ4J9022	ON	OFF	MOM
	ST2-5L5S5ZQJ4J9022	UL25L5S5ZQJ4J9022	ON	NONE	MOM
	ST2-6L5S5ZQJ4J9022	UL26L5S5ZQJ4J9022	ON	ON	ON
	ST2-7L5S5ZQJ4J9022	UL27L5S5ZQJ4J9022	ON	ON	MOM
	ST2-8L5S5ZQJ4J9022	UL28L5S5ZQJ4J9022	MOM	ON	MOM
Terminals connected (-6, -7 & -8)			1-2, 4-5	1-2, 5-6	2-3, 5-6

Above models have black bezel & actuator.

# ST SERIES - MINIATURE ROCKER & LEVER SWITCHES

**B**

## Straight p.c. terminals - p.c. mounting bezel

**SINGLE POLE WITH J3 ROCKER**

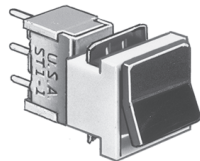

	DRY CKT. MODEL NO.	UL MODEL NO.	USA marking on other side		
Single pole	ST1-1L5S5CBJ3J9322	UL11L5S5CQJ3J9322	ON	NONE	ON
	ST1-2L5S5CBJ3J9322	UL12L5S5CQJ3J9322	ON	OFF	ON
	ST1-3L5S5CBJ3J9322	UL13L5S5CQJ3J9322	MOM	OFF	MOM
	ST1-4L5S5CBJ3J9322	UL14L5S5CQJ3J9322	ON	OFF	MOM
	ST1-5L5S5CBJ3J9322	UL15L5S5CQJ3J9322	ON	NONE	MOM
Double pole	ST2-1L5S5CBJ3J9322	UL21L5S5CQJ3J9322	ON	NONE	ON
	ST2-2L5S5CBJ3J9322	UL22L5S5CQJ3J9322	ON	OFF	ON
	ST2-3L5S5CBJ3J9322	UL23L5S5CQJ3J9322	MOM	OFF	MOM
	ST2-4L5S5CBJ3J9322	UL24L5S5CQJ3J9322	ON	OFF	MOM
	ST2-5L5S5CBJ3J9322	UL25L5S5CQJ3J9322	ON	NONE	MOM
	ST2-6L5S5CBJ3J9322	UL26L5S5CQJ3J9322	ON	ON	ON
	ST2-7L5S5CBJ3J9322	UL27L5S5CQJ3J9322	ON	ON	MOM
	ST2-8L5S5CBJ3J9322	UL28L5S5CQJ3J9322	MOM	ON	MOM
Terminals connected (-6, -7 & -8)			1-2, 4-5	1-2, 5-6	2-3, 5-6

Above models have black bezel & actuator.

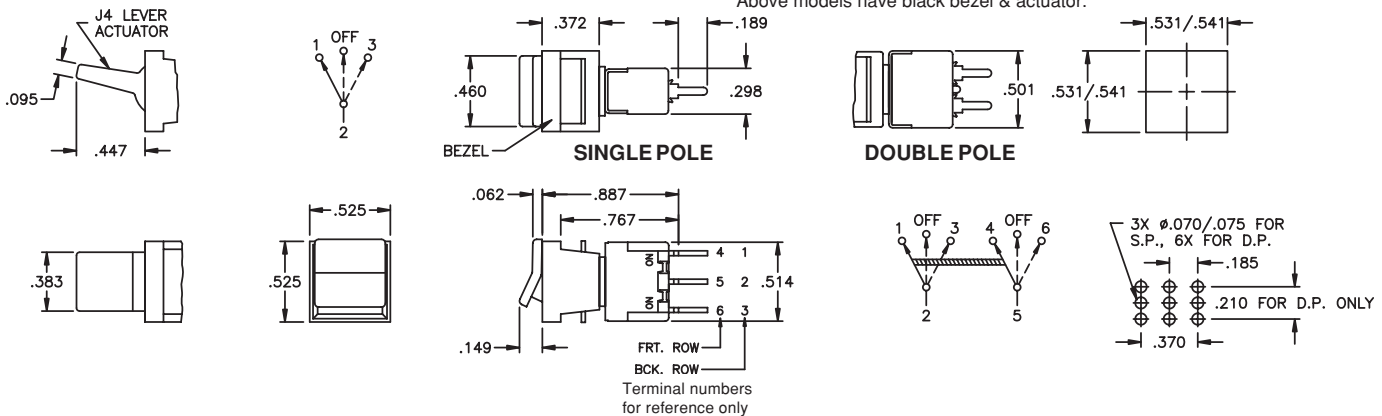

## Straight p.c. terminals w/bracket - p.c. mounting bezel

**SINGLE POLE WITH J4 LEVER**

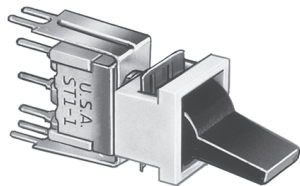

	DRY CKT. MODEL NO.	UL MODEL NO.	USA marking on other side		
Single pole	ST1-1L5S5V30BJ3J9322	UL11L5S5V30QJ3J9322	ON	NONE	ON
	ST1-2L5S5V30BJ3J9322	UL12L5S5V30QJ3J9322	ON	OFF	ON
	ST1-3L5S5V30BJ3J9322	UL13L5S5V30QJ3J9322	MOM	OFF	MOM
	ST1-4L5S5V30BJ3J9322	UL14L5S5V30QJ3J9322	ON	OFF	MOM
	ST1-5L5S5V30BJ3J9322	UL15L5S5V30QJ3J9322	ON	NONE	MOM
Double pole	ST2-1L5S5V30BJ3J9322	UL21L5S5V30QJ3J9322	ON	NONE	ON
	ST2-2L5S5V30BJ3J9322	UL22L5S5V30QJ3J9322	ON	OFF	ON
	ST2-3L5S5V30BJ3J9322	UL23L5S5V30QJ3J9322	MOM	OFF	MOM
	ST2-4L5S5V30BJ3J9322	UL24L5S5V30QJ3J9322	ON	OFF	MOM
	ST2-5L5S5V30BJ3J9322	UL25L5S5V30QJ3J9322	ON	NONE	MOM
	ST2-6L5S5V30BJ3J9322	UL26L5S5V30QJ3J9322	ON	ON	ON
	ST2-7L5S5V30BJ3J9322	UL27L5S5V30QJ3J9322	ON	ON	MOM
	ST2-8L5S5V30BJ3J9322	UL28L5S5V30QJ3J9322	MOM	ON	MOM
Terminals connected (-6, -7 & -8)			1-2, 4-5	1-2, 5-6	2-3, 5-6

Above models have black bezel & actuator.

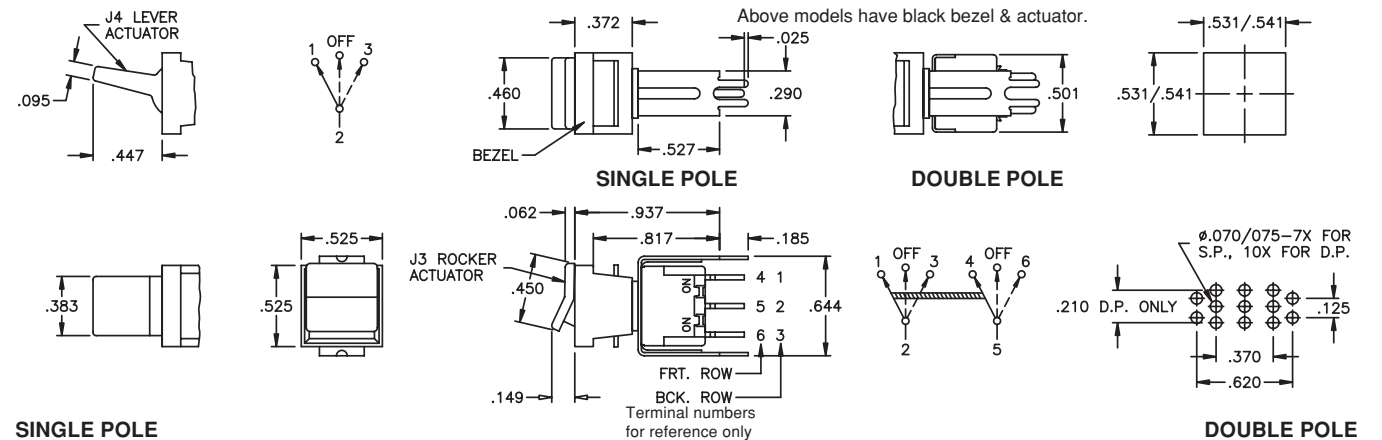

SPECIFICATIONS SUBJECT TO CHANGE WITHOUT NOTICE

# ST SERIES - MINIATURE ROCKER & LEVER SWITCHES

## Horizontal right angle p.c. terminals - p.c. mtg. bezel

**SINGLE POLE WITH J3 ROCKER**

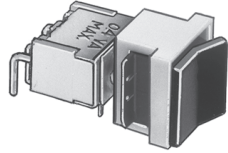

Poles	Option	Dim. A	Dim. B
SP	A	.148	.045 max.
SP	A-1	.164	.095 max.
DP	A	.250	.300 max.
DP	A-1	.266	.350 max.

	DRY CKT. MODEL NO.	UL MODEL NO.	USA marking on other side		
Single pole	ST1-1L5S5A-1BJ3J9322	UL11L5S5A-1QJ3J9322	ON	NONE	ON
	ST1-2L5S5A-1BJ3J9322	UL12L5S5A-1QJ3J9322	ON	OFF	ON
	ST1-3L5S5A-1BJ3J9322	UL13L5S5A-1QJ3J9322	MOM	OFF	MOM
	ST1-4L5S5A-1BJ3J9322	UL14L5S5A-1QJ3J9322	ON	OFF	MOM
	ST1-5L5S5A-1BJ3J9322	UL15L5S5A-1QJ3J9322	ON	NONE	MOM
Double pole	ST2-1L5S5A-1BJ3J9322	UL21L5S5A-1QJ3J9322	ON	NONE	ON
	ST2-2L5S5A-1BJ3J9322	UL22L5S5A-1QJ3J9322	ON	OFF	ON
	ST2-3L5S5A-1BJ3J9322	UL23L5S5A-1QJ3J9322	MOM	OFF	MOM
	ST2-4L5S5A-1BJ3J9322	UL24L5S5A-1QJ3J9322	ON	OFF	MOM
	ST2-5L5S5A-1BJ3J9322	UL25L5S5A-1QJ3J9322	ON	NONE	MOM
	ST2-6L5S5A-1BJ3J9322	UL26L5S5A-1QJ3J9322	ON	ON	ON
	ST2-7L5S5A-1BJ3J9322	UL27L5S5A-1QJ3J9322	ON	ON	MOM
	ST2-8L5S5A-1BJ3J9322	UL28L5S5A-1QJ3J9322	MOM	ON	MOM
Terminals connected (-6, -7 & -8)			1-2, 4-5	1-2, 5-6	2-3, 5-6

SPECIFICATIONS SUBJECT TO CHANGE WITHOUT NOTICE

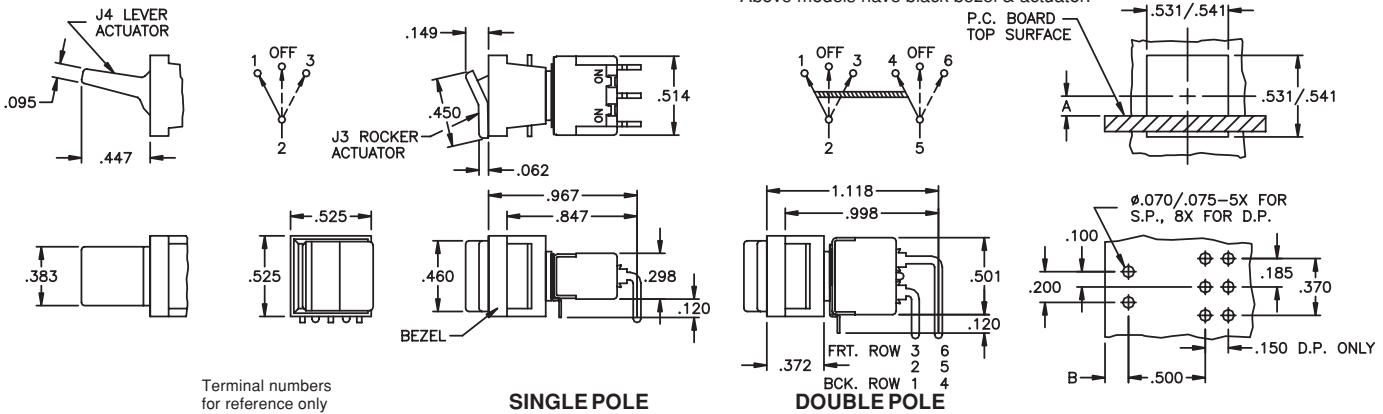

Above models have black bezel & actuator.

## Vertical right angle p.c. terminals - p.c. mtg. bezel

**SINGLE POLE WITH J4 LEVER**

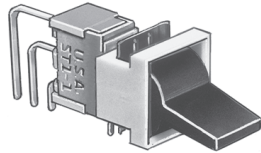

	DRY CKT. MODEL NO.	UL MODEL NO.	USA marking on other side		
Single pole	ST1-1L5S5V-1BJ3J9322	UL11L5S5V-1QJ3J9322	ON	NONE	ON
	ST1-2L5S5V-1BJ3J9322	UL12L5S5V-1QJ3J9322	ON	OFF	ON
	ST1-3L5S5V-1BJ3J9322	UL13L5S5V-1QJ3J9322	MOM	OFF	MOM
	ST1-4L5S5V-1BJ3J9322	UL14L5S5V-1QJ3J9322	ON	OFF	MOM
	ST1-5L5S5V-1BJ3J9322	UL15L5S5V-1QJ3J9322	ON	NONE	MOM
Double pole	ST2-1L5S5V-1BJ3J9322	UL21L5S5V-1QJ3J9322	ON	NONE	ON
	ST2-2L5S5V-1BJ3J9322	UL22L5S5V-1QJ3J9322	ON	OFF	ON
	ST2-3L5S5V-1BJ3J9322	UL23L5S5V-1QJ3J9322	MOM	OFF	MOM
	ST2-4L5S5V-1BJ3J9322	UL24L5S5V-1QJ3J9322	ON	OFF	MOM
	ST2-5L5S5V-1BJ3J9322	UL25L5S5V-1QJ3J9322	ON	NONE	MOM
	ST2-6L5S5V-1BJ3J9322	UL26L5S5V-1QJ3J9322	ON	ON	ON
	ST2-7L5S5V-1BJ3J9322	UL27L5S5V-1QJ3J9322	ON	ON	MOM
	ST2-8L5S5V-1BJ3J9322	UL28L5S5V-1QJ3J9322	MOM	ON	MOM
Terminals connected (-6, -7 & -8)			1-2, 4-5	1-2, 5-6	2-3, 5-6

Above models have black bezel & actuator.

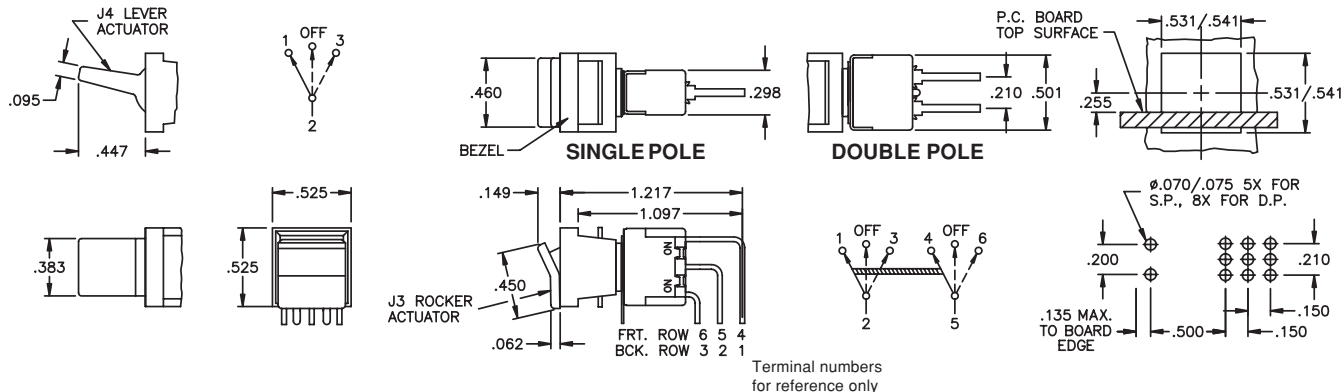

# ST SERIES - MINIATURE ROCKER & LEVER SWITCHES

**Snap-in bezel for round hole mounting**  
Self-keying against rotation

**B**

ST1-1L5S5ZQJ4J9682

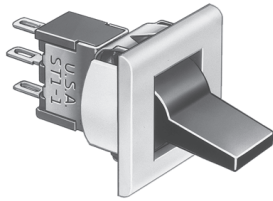

	POWER CKT. MODEL NO.	UL MODEL NO.	USA marking on other side		
Single pole	ST1-1L5S5ZQJ4J9622	UL11L5S5ZQJ4J9622	ON	NONE	ON
	ST1-2L5S5ZQJ4J9622	UL12L5S5ZQJ4J9622	ON	OFF	ON
	ST1-3L5S5ZQJ4J9622	UL13L5S5ZQJ4J9622	MOM	OFF	MOM
	ST1-4L5S5ZQJ4J9622	UL14L5S5ZQJ4J9622	ON	OFF	MOM
	ST1-5L5S5ZQJ4J9622	UL15L5S5ZQJ4J9622	ON	NONE	MOM
Double pole	ST2-1L5S5ZQJ4J9622	UL21L5S5ZQJ4J9622	ON	NONE	ON
	ST2-2L5S5ZQJ4J9622	UL22L5S5ZQJ4J9622	ON	OFF	ON
	ST2-3L5S5ZQJ4J9622	UL23L5S5ZQJ4J9622	MOM	OFF	MOM
	ST2-4L5S5ZQJ4J9622	UL24L5S5ZQJ4J9622	ON	OFF	MOM
	ST2-5L5S5ZQJ4J9622	UL25L5S5ZQJ4J9622	ON	NONE	MOM
	ST2-6L5S5ZQJ4J9622	UL26L5S5ZQJ4J9622	ON	ON	ON
	ST2-7L5S5ZQJ4J9622	UL27L5S5ZQJ4J9622	ON	ON	MOM
	ST2-8L5S5ZQJ4J9622	UL28L5S5ZQJ4J9622	MOM	ON	MOM
Terminals connected (-6, -7 & -8)			1-2, 4-5	1-2, 5-6	2-3, 5-6

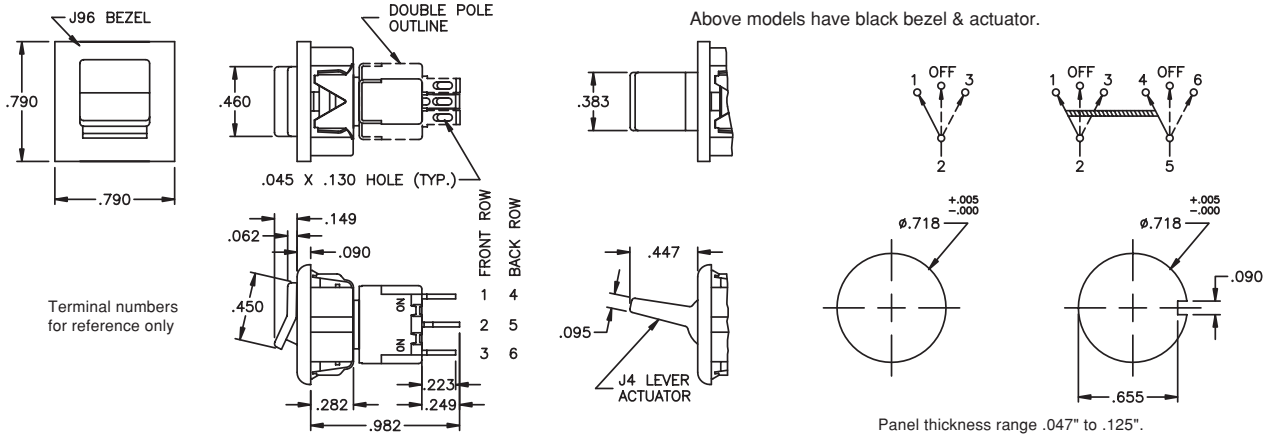

## MISCELLANEOUS

### ST2-6, -7 & -8 SWITCHES

May be wired as a single pole 3 position switch; add external jumper between terminals 1 & 5, then:

Common terminal is 2  
Output 1 - terminal 4  
Output 2 - terminal 6  
Output 3 - terminal 3

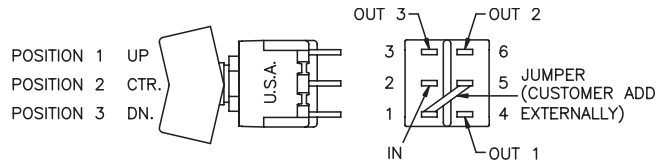

### SWITCH BODY

**SIZES WITH TERMINAL LOCATION DIMENSIONS**

SIDE VIEW SINGLE POLE

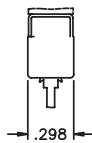

SIDE VIEW DOUBLE POLE

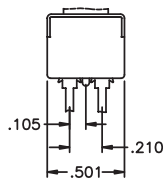

FRONT VIEW SINGLE AND DOUBLE POLE

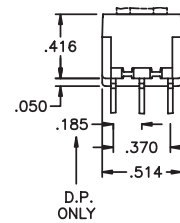

## TYPICAL SWITCH CROSS SECTIONS

Note: Contacts make opposite actuator direction.

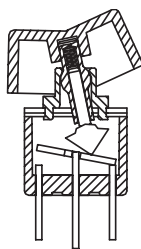

ON NONE ON

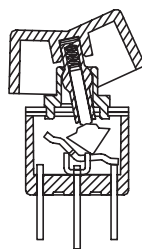

ON OFF ON

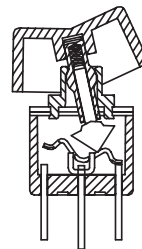

MOM OFF MOM

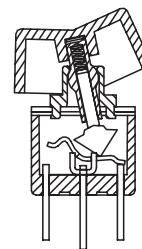

ON OFF MOM

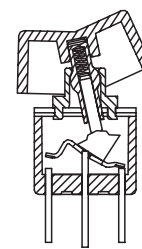

ON NONE MOM

# ST SERIES - MINIATURE ROCKER & LEVER SWITCHES

**Additional ordering information:** Commonly ordered models are shown on prior pages with complete model numbers and specifications. Below is an order format that enables you to 'build your own switch' and specify the correct switch model number by simply selecting from all available options shown and filling in the boxes.

## 'BUILD YOUR OWN SWITCH' ORDER FORMAT

Fill in boxes with selections shown for **Model Structure**, then add **Options** selections for complete model number. Allowable options are shown below each respective box with brief description - see option dwgs. & info. following. Note: 'NONE' indicates box may be left empty.

### Model Structure:

Series	Electrical functions	Sub-actuators	Sub-Bushings	Terminations	Contact materials
<input type="text"/>	<input type="text"/>	<input type="text"/>	<input type="text"/>	<input type="text"/>	<input type="text"/>
Single pole: <b>S T 1 -</b> S.P. UL model: <b>U L 1</b>	<b>1</b> ON NONE ON <b>2</b> ON OFF ON <b>3</b> MOM OFF MOM <b>4</b> ON OFF MOM	<b>L 4</b> Specify without bezel <b>L 5</b> Specify with bezel	<b>S 4</b> Specify without bezel <b>S 5</b> Specify with bezel	<b>Z</b> Solder lug <b>C</b> Printed circuit <b>W</b> Wirewrap <b>W 1</b> Lg. wirewrap <b>W 3</b> Sht. wirewrap <b>X</b> Extra lg. wirewrap Horiz. right angle p.c.: <b>A</b> <b>A - 1</b> Vertical right angle p.c.: <b>V</b> <b>V - 1</b> <b>V - 2</b> Straight p.c. terms. w/brkt.: <b>V 3 0 or V 3 1</b> <b>V 4 0 or V 4 1</b> <b>V 7 0 or V 7 1</b> <b>V 8 0 or V 8 1</b>	<b>B</b> Gold <b>Q</b> Coin silver <b>G</b> Gold over coin silver <b>N</b> Economy gold <b>T</b> Economy silver
Double pole: <b>S T 2 -</b> D.P. UL model: <b>U L 2</b>	<b>5</b> ON - MOM Following for DP only <b>6</b> ON ON ON <b>7</b> ON ON MOM <b>8</b> MOM ON MOM				

Although most combinations of options are available, some may result in incompatibilities. Consult factory if there is any question.

Example of completely specified model number:  
**ST2-3L5S5ZQEJ4J9622**

### Options:

Sealing	Actuator	Bezel	Bezel color	Actuator color	Recognition
<input type="text"/>	<input type="text"/>	<input type="text"/>	<input type="text"/>	<input type="text"/>	<input type="text"/>
(NONE) E Epoxy	<b>J 1</b> Rocker <b>J 2</b> Lever <b>J 3</b> Small rocker <b>J 4</b> Small lever	(NONE) <b>J 6 1</b> Snap-in w/LED <b>J 9 0</b> Snap-in no LED <b>J 9 3</b> P.C. style Self-keying round hole mt.: <b>J 9 6</b> Snap-in no LED <b>Note: specify J3 or J4 actuators only with bezels.</b>	(NONE) <b>2</b> Black <b>6</b> Red <b>8</b> White	<b>2</b> Black <b>6</b> Red <b>8</b> White <b>Note: J3 &amp; J4 actuators available in black only.</b>	(NONE) / <b>C S A</b> CSA listing

### ACTUATOR OPTIONS

Colors available: J1 & J2: Black, red or white. J3 & J4: Black.

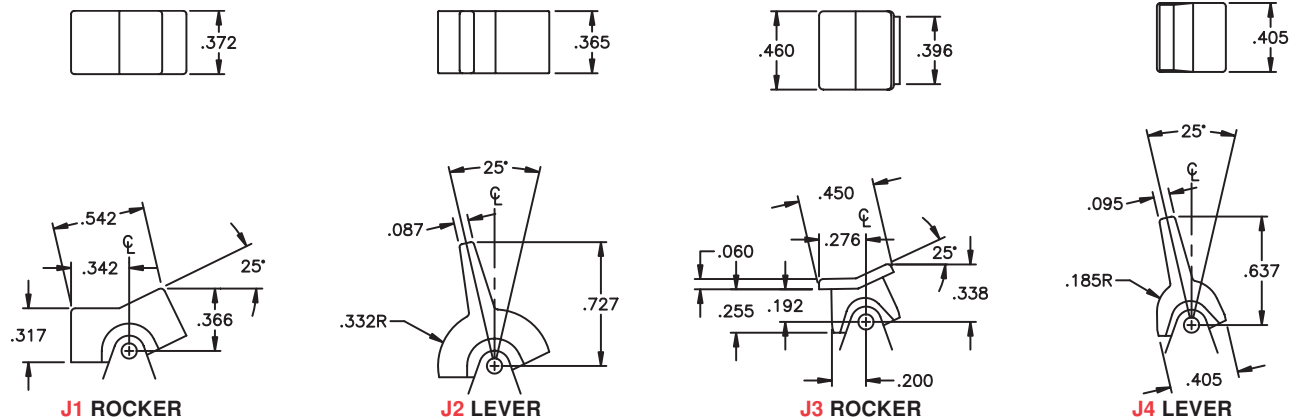



# ST SERIES - MINIATURE ROCKER & LEVER SWITCHES

## TERMINATION OPTIONS

**B**

**A**

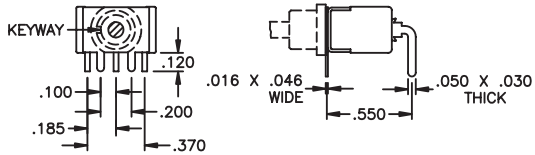

SINGLE POLE HORIZONTAL P.C. MOUNTING

**A-1**

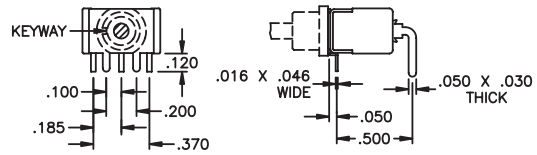

SINGLE POLE HORIZONTAL P.C. MOUNTING

**A**

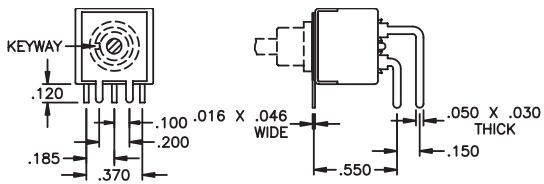

DOUBLE POLE HORIZONTAL P.C. MOUNTING

**A-1**

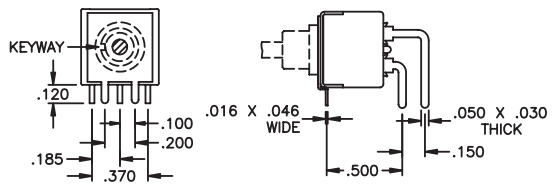

DOUBLE POLE HORIZONTAL P.C. MOUNTING

### V, V-1 & V-2

Option	Dim. A	Dim. B
V	.550	.150
V-1	.500	.150
V-2	.500	.100

FRONT VIEW SINGLE POLE

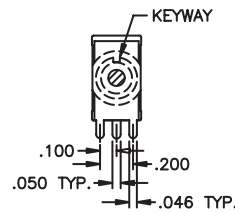

FRONT VIEW DOUBLE POLE

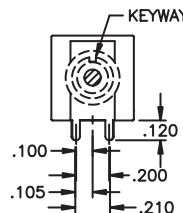

SIDE VIEW - SINGLE & DOUBLE POLE

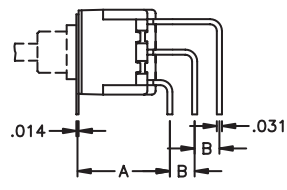

VERTICAL P.C. MOUNTING

### V30, V40, V70, V80, V31, V41, V71 & V81

PANEL LAYOUT V30, V31, V40 & V41

Option	Dim. A	Dim. B
V30-V31	.527	.024
V40-V41	.647	.048

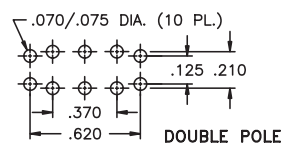
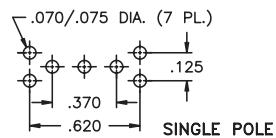

FRONT VIEW SINGLE POLE

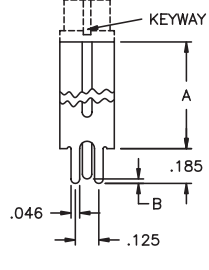

FRONT VIEW DOUBLE POLE

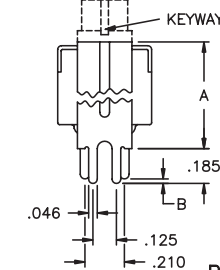

SIDE VIEW - SINGLE AND DOUBLE POLE

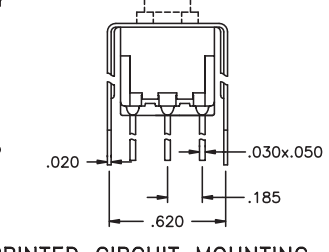

PRINTED CIRCUIT MOUNTING

PANEL LAYOUT V70, V71, V80 & V81

Option	Dim. A
V70-V71	.630
V80-V81	.953

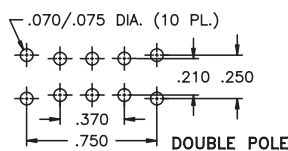
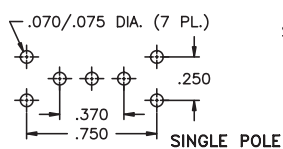

FRONT VIEW SINGLE POLE

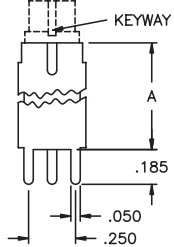

FRONT VIEW DOUBLE POLE

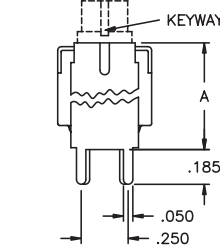

SIDE VIEW - SINGLE AND DOUBLE POLE

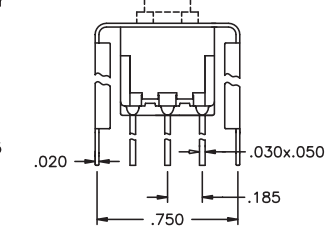

PRINTED CIRCUIT MOUNTING

V31, V41, V71 & V81 ARE THE SAME AS V30, V40, V70 & V80 RESPECTIVELY, EXCEPT WITH CRIMPED LEG DESIGN FOR P.C. BOARD RETENTION, AS SHOWN TO RIGHT.

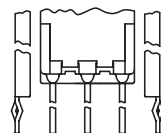
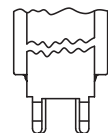
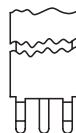

SPECIFICATIONS SUBJECT TO CHANGE WITHOUT NOTICE

# ST SERIES - MINIATURE ROCKER & LEVER SWITCHES

## TERMINATION OPTIONS (CONT'D.)

SPECIFICATIONS SUBJECT TO CHANGE WITHOUT NOTICE

<p><b>Z</b></p> <p><b>SOLDER LUG</b></p>	<p><b>C</b></p> <p><b>PRINTED CIRCUIT</b></p>	<p><b>W</b></p> <p><b>WIREWRAP</b></p>	<p><b>W1</b></p> <p><b>LONG WIREWRAP</b></p>	<p><b>W3</b></p> <p><b>SHORT WIREWRAP</b></p>	<p><b>X</b></p> <p><b>EXTRA LG. WIREWRAP</b></p>
--	---	--	--	---	--

**B**

## CONTACT MATERIAL OPTIONS

- B** Dry circuit - gold over nickel over brass.  
RATING: 0.4 Volt-Amps (VA) max. at 20 V max.  
ELECTRIC LIFE: 100,000 cycles min. (ST1-1 & ST2-1 only - other models 40,000 cycles min.)
- Q** Power circuit - coin silver.  
RATING: 6 Amps at 125 VAC, 3 Amps at 250 VAC or 7 Amps at 30 VDC (resistive loads).  
ELECTRIC LIFE: 100,000 cycles min. (ST1-1 & ST2-1 only - other models 40,000 cycles min.)
- G** Dry circuit or power circuit - gold over nickel over coin silver.  
RATINGS & ELECTRIC LIFE: Same as B & Q above - i.e. - can be used in either dry circuit or power circuit, however once used in power circuit, switch cannot be re-used in dry circuit. This option satisfies those customers who have both dry circuit and power circuit requirements, but prefer to inventory only one switch for both.
- N** Dry circuit - gold over nickel over brass. Note- less gold than B option.  
RATING: 0.4 Volt-Amps (VA) max. at 20 V max.  
ELECTRIC LIFE: 10,000 cycles min. at 13 cycles per minute.
- T** Power circuit - Silver plate over brass.

Solder dipped terminals and custom contact plating available - contact factory.

## UL & CSA OPTIONS

- UL** For power circuits - coin silver  
RATING: 6 Amps at 125 VAC or 3 Amps at 250 VAC (75% power factor).  
Underwriter Laboratories file no. E66367. To specify, order UL model no. Note - applicable only to terminations with coin silver contacts (Q or G options).
- CSA** For power circuits - coin silver  
RATING: 6 Amps at 125 VAC or 3 Amps at 250 VAC (75% power factor). Canadian Standards Association file no. LR54592-1. To specify, order UL model number, then add '/CSA' to complete switch number. Note - applicable only to terminations with coin silver contacts (Q or G options) as CSA recognizes switches for power applications only.

## SEALING & MISCELLANEOUS OPTIONS

- E** Epoxy terminal sealing: Available with all terminal configurations.  
The space between terminal & case hole is sealed with epoxy all around terminal.  
Provides maximum protection from entry of flux or contaminants into the switch case.

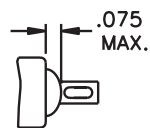

- /R** To specify reverse switch action on non-symmetrical models with bushing keyway, add '/R' to switch model no.

# ST SERIES - MINIATURE ROCKER & LEVER SWITCHES

## MOUNTING INFORMATION & PANEL CUT-OUTS

**B**

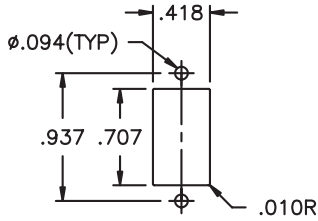

J1 OR J2		
Panel thickness.	Hardware number	Stand-off length
1/16"	<b>A322-3</b>	.295
3/32"	<b>A322-2</b>	.264
1/8"	<b>A322-1</b>	.233

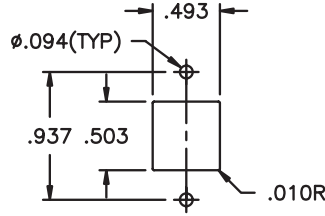

J3		
Panel thickness.	Hardware number	Stand-off length
1/16"	<b>A322-2</b>	.264
3/32"	<b>A322-1</b>	.233
1/8"	<b>A322-4</b>	.202

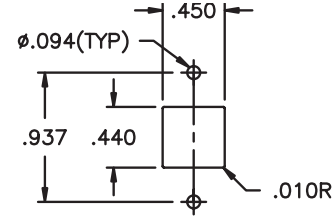

J4		
Panel thickness.	Hardware number	Stand-off length
1/16"	<b>A322-1</b>	.233
3/32"	<b>A322-4</b>	.202
1/8"	<b>A322-5</b>	.171

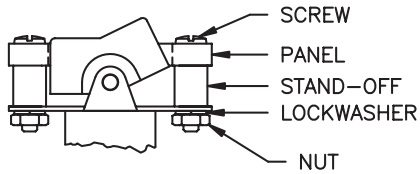

**TYPICAL ASSEMBLY**

Mounting hardware consists of 2 each:  
 Hex Nut, stainless steel  
 Screw, stainless steel  
 Lockwasher, stainless steel  
 Stand-off, aluminum

**1/8" panel hardware supplied if not specified separately by hardware number shown in tables.**

SPECIFICATIONS SUBJECT TO CHANGE WITHOUT NOTICE