

DO NOT SCALE FROM THIS PRINT

DESIGNED & DIMENSIONED IN MILLIMETERS [INCHES]

-01 LEAD STYLE

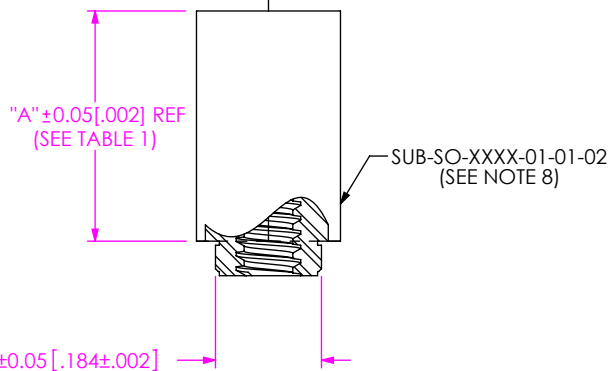
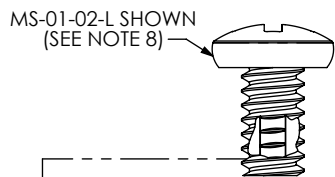
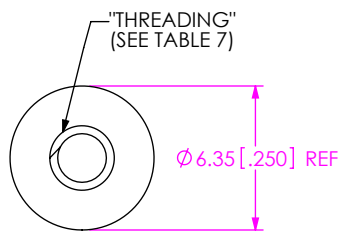
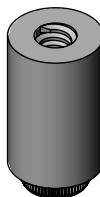

FIG 1
SO-XXXX-01-01-02-L SHOWN



SO-XXXX-XX-XX-XX-X-X

BOARD STACK HEIGHT

- 0165,-0175,-0310,-0318,-0515,-0690,-0715,-0815,-0865,-0915,-0965,-1015,-1115,-1215,-1315,-1415,-1515,-1524,-1615,-1715,-1890,-1915,-2015,-2200,-2215,-2515,-3015

LEAD STYLE

- 01: FEMALE THREAD/PRESS-IN (SEE FIG. 1, SHT. 1) SEE NOTE 6
- 02: MALE/MALE THREADED (SEE FIG 2, SHT. 2) SEE NOTE 7
- 03: MALE/FEMALE THREADED (SEE FIG. 3, SHT. 3) SEE NOTE 10
- 04: FEMALE/PRESS-IN (SEE FIG.4, SHT.4) SEE NOTE 9
- 05: FEMALE/FEMALE THREADED (SEE FIG. 5 SHT. 5)
- 06: MALE/MALE THREADED (SEE FIG 6, SHT. 6)

KIT OPTION

- N: NO HARDWARE (STANDOFF ONLY; SEE TABLE 2) LEAVE BLANK FOR KIT

LOCKING OPTION

- L: LOCKING COMPOUND (NOT AVAILABLE WITH -04 OR -N OPTION ON -01 AND -05 LEAD STYLES)

MATERIAL

- 01: 6061 ALUMINUM
- 02: 303 STAINLESS STEEL

THREADING

- 01: #4-40
- 02: M3 x 0.5 x 4.76mm
- 03: M2 x 0.4 x 4.76mm

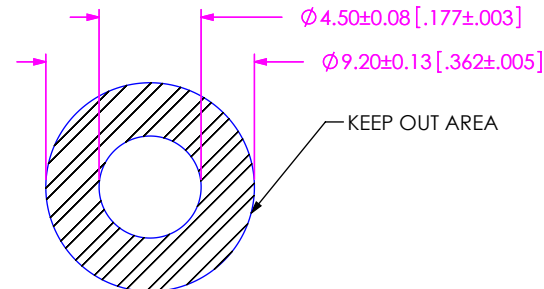

RECOMMENDED BOARD CUTOUT (PRESS-IN)

TABLE 1	
01 LEAD STYLE AVAILABILITY	
BOARD STACK HEIGHT	"A"
-0515	5.15 [0.203]
-0575	5.75 [0.226]
-0600	6.00 [0.236]
-0690	6.90 [0.272]
-0715	7.15 [0.281]
-0815	8.15 [0.321]
-0865	8.65 [0.341]

TABLE 7	
STYLE	THREADING
-01	#4-40 UNC 2A
	#4-40 UNC 2B
-02	M3 x 0.5 6g
	M3 x 0.5 6H
-03	M2 x 0.4 6g
	M2 x 0.4 6H

- NOTES:
1. DELETED
 2. DELETED
 3. DELETED
 4. STANDOFFS TO BE USED WITH 1.57[.062]MIN THICK BOARDS.
 5. NOTE DELETED..
 6. -01 LEAD STYLE ONLY AVAILABLE FOR BOARD STACK HEIGHTS -0515 THRU -0965.
 7. -02 LEAD STYLE ONLY AVAILABLE FOR TOOLED BOARD STACK HEIGHTS, SEE TABLE 3, SHT 2 FOR TOOLED STACKS.
 8. COMPONENTS ARE TO BE PACKAGED IN SEPARATE BAGS UNASSEMBLED AND NOT LABELED. COMBINE SEPARATE BAGS IN ONE LARGER BAG WITH PART NUMBER AND QUANTITY.
 9. -04 LEAD STYLE ONLY AVAILABLE FOR BOARD STACK HEIGHT -0165, -0175, -0310 AND -0318.
 10. -03 LEAD STYLE ONLY AVAILABLE FOR TOOLED BOARD STACK HEIGHTS, SEE TABLE 4, SHT 3. FOR TOOLED HEIGHTS.
 11. NOTE DELETED.
 12. REPRESENTS A CRITICAL DIMENSION.
 13. STANDOFFS ARE DESIGNED .15MM LONGER THAN CONNECTOR STACK HEIGHTS TO ALLOW FOR PROCESSING VARIABLES.
 14. TORQUE TO 2.5 – 3.5 IN*LBS TO SECURE FASTENER IN A STATIC ENVIRONMENT ASSUMING RECOMMENDED BOARD TO BOARD DISTANCES ARE ACHIEVED WITHOUT DAMAGE TO THE PCB, HARDWARE OR OTHER COMPONENTS.
 15. FOR -L OPTION, SPREAD LOCKING COMPOUND OVER 5 THREADS OR AT LEAST 0.105".

UNLESS OTHERWISE SPECIFIED, DIMENSIONS ARE IN MILLIMETERS. TOLERANCES ARE:
 DECIMALS ANGLES
 X.X: ±0.25 [.01] 2°
 X.XX: ±0.05 [.002]

PROPRIETARY NOTE
 * THIS DOCUMENT CONTAINS CONFIDENTIAL AND PROPRIETARY INFORMATION AND ALL DESIGN, MANUFACTURING, REPRODUCTION, USE, PATENT RIGHTS AND SALES RIGHTS ARE EXPRESSLY RESERVED BY SAMTEC, INC. THIS DOCUMENT SHALL NOT BE DISCLOSED, IN WHOLE OR PART, TO ANY UNAUTHORIZED PERSON OR ENTITY NOR REPRODUCED, TRANSFERRED OR INCORPORATED IN ANY OTHER PROJECT IN ANY MANNER WITHOUT THE EXPRESS WRITTEN CONSENT OF SAMTEC, INC.



520 PARK EAST BLVD. NEW ALBANY, IN 47150
 PHONE: 812-944-6733 FAX: 812-948-5047
 e-Mail info@SAMTEC.com code 55322

MATERIAL: DO NOT SCALE DRAWING SHEET SCALE: 1:0.333333
 SEE PART CALL OUT FOR MATERIAL

DESCRIPTION: BOARD TO BOARD STANDOFF

DWG. NO. **SO-XXXX-XX-XX-XX-X**

BY: T.NEWTON 12/6/2007 SHEET 1 OF 7

"THREADING"
(SEE TABLE 7)

-02 LEAD STYLE

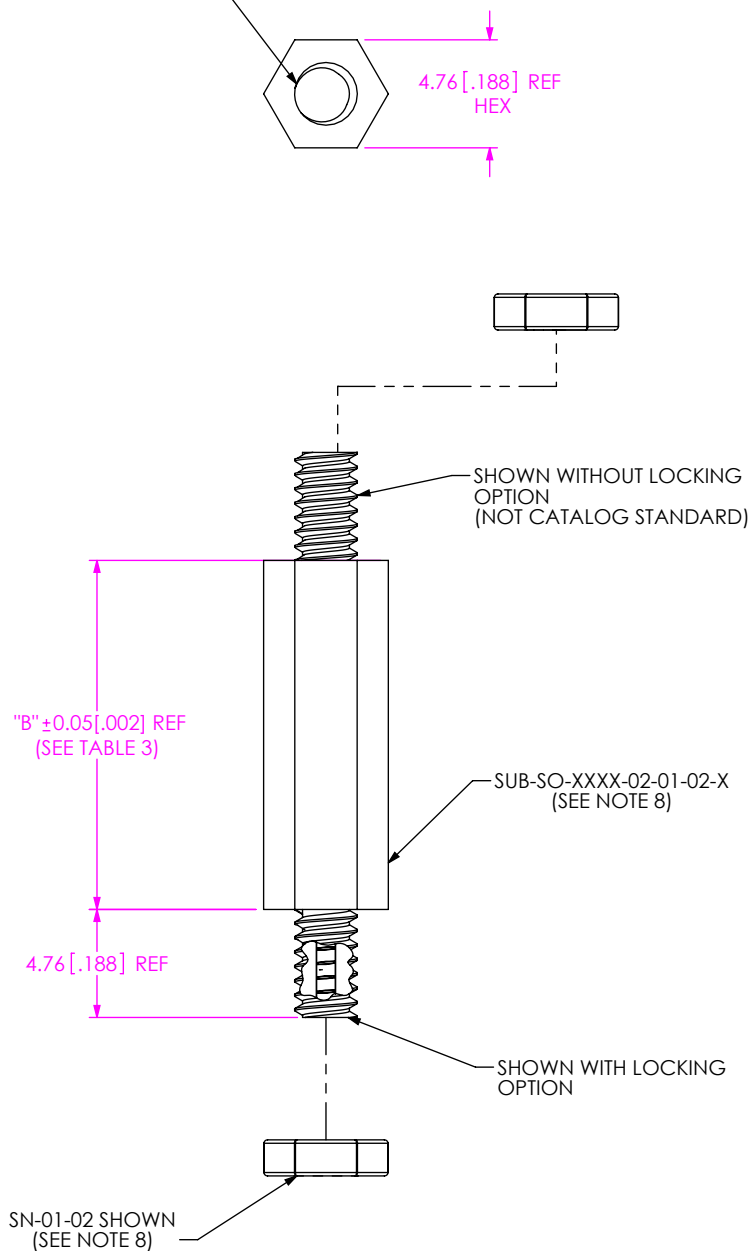
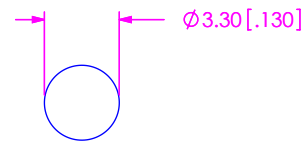
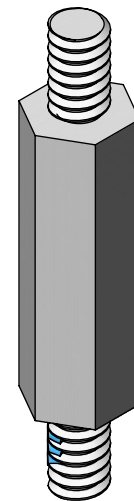

FIG 2
SO-XXXX-02-01-02-X SHOWN



RECOMMENDED BOARD
CUTOUT (#4-40)

TABLE 3	
02 LEAD STYLE AVAILABILITY	
BOARD STACK HEIGHT	"B"
-0515	5.15 [.203]
-0715	7.15 [.282]
-0865	8.65 [.341]
-1015	10.15 [.400]
-1115	11.15 [.439]
-1215	12.15 [.478]
-1315	13.15 [.518]
-1415	14.15 [.557]
-1515	15.15 [.597]
-1524	15.24 [.600]
-1615	16.15 [.636]
-1715	17.15 [.675]
-1890	18.90 [.744]
-1915	19.15 [.754]
-2015	20.15 [.793]
-2215	22.15 [.872]
-2515	25.15 [.990]
-3015	30.15 [1.187]

PROPRIETARY NOTE
THIS DOCUMENT CONTAINS CONFIDENTIAL AND PROPRIETARY INFORMATION AND ALL DESIGN, MANUFACTURING, REPRODUCTION, USE, PATENT RIGHTS AND SALES RIGHTS ARE EXPRESSLY RESERVED BY SAMTEC, INC. THIS DOCUMENT SHALL NOT BE DISCLOSED, IN WHOLE OR PART, TO ANY UNAUTHORIZED PERSON OR ENTITY NOR REPRODUCED, TRANSFERRED OR INCORPORATED IN ANY OTHER PROJECT IN ANY MANNER WITHOUT THE EXPRESS WRITTEN CONSENT OF SAMTEC, INC.



520 PARK EAST BLVD, NEW ALBANY, IN 47150
PHONE: 812-944-6733 FAX: 812-948-5047
e-Mail info@SAMTEC.com code 55322

DO NOT SCALE DRAWING

DESCRIPTION: BOARD TO BOARD STANDOFF

DWG. NO. SO-XXXX-XX-XX-XX-X

SHEET SCALE: 1:0.333333

BY: T.NEWTON 12/6/2007 SHEET 2 OF 7

-03 LEAD STYLE

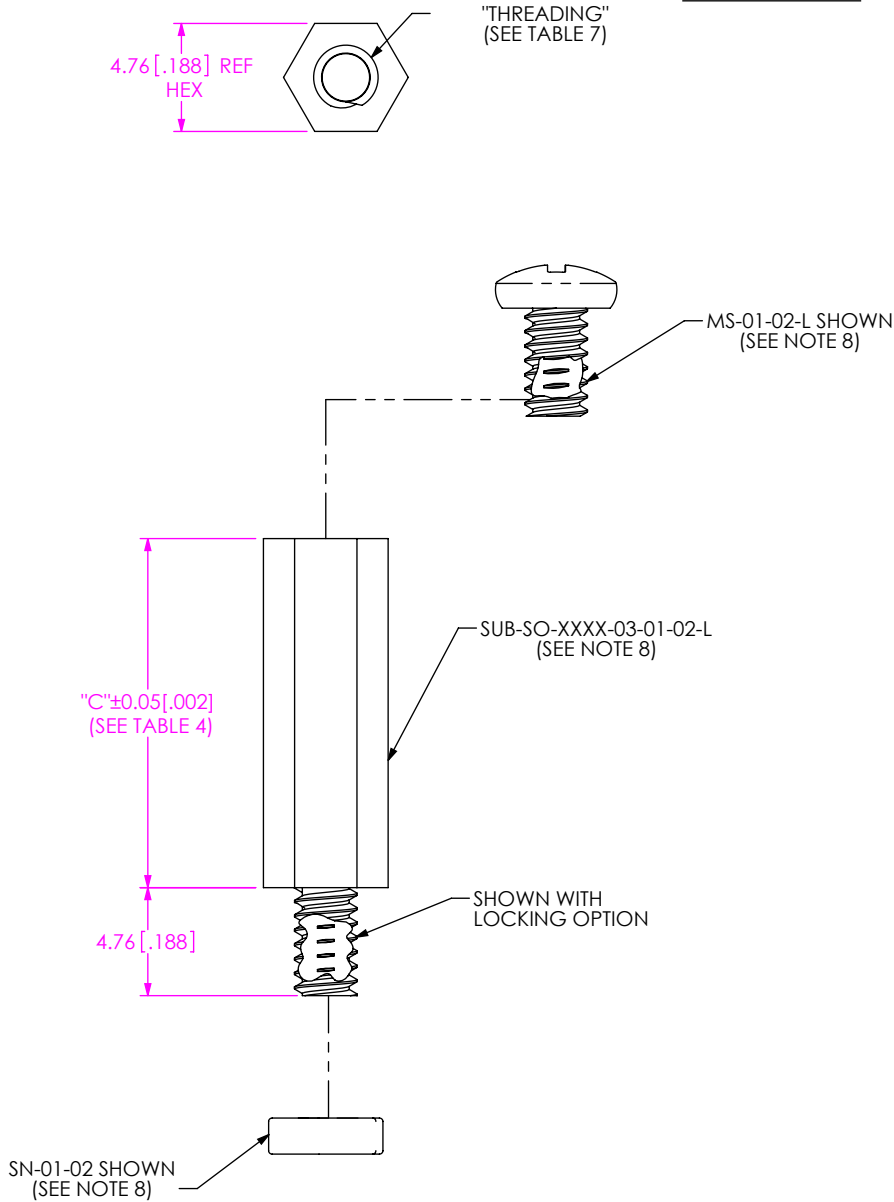
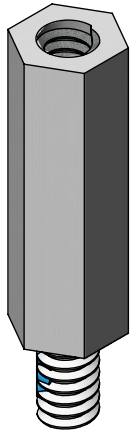

FIG 3
SO-XXXX-03-01-02-X SHOWN
(SAME AS -02 LEAD STYLE,
EXCEPT WHERE STATED)

TABLE 4	
03 LEAD STYLE AVAILABILITY	
BOARD STACK HEIGHT	"C"
-0815	8.15[.321]
-0865	8.65[.341]
-0915	9.15[.360]
-0965	9.65[.380]
-1015	10.15[.400]
-1115	11.15[.439]
-1215	12.15[.478]
-1315	13.15[.518]
-1415	14.15[.557]
-1515	15.15[.597]
-1524	15.24[.600]
-1615	16.15[.636]
-1715	17.15[.675]
-1890	18.90[.744]
-1915	19.15[.754]
-2015	20.15[.793]
-2200	22.00[.866]
-2215	22.15[.872]
-2515	25.15[.990]
-3015	30.15[1.187]



PROPRIETARY NOTE
THIS DOCUMENT CONTAINS CONFIDENTIAL AND PROPRIETARY INFORMATION AND ALL DESIGN, MANUFACTURING, REPRODUCTION, USE, PATENT RIGHTS AND SALES RIGHTS ARE EXPRESSLY RESERVED BY SAMTEC, INC. THIS DOCUMENT SHALL NOT BE DISCLOSED, IN WHOLE OR PART, TO ANY UNAUTHORIZED PERSON OR ENTITY NOR REPRODUCED, TRANSFERRED OR INCORPORATED IN ANY OTHER PROJECT IN ANY MANNER WITHOUT THE EXPRESS WRITTEN CONSENT OF SAMTEC, INC.



520 PARK EAST BLVD, NEW ALBANY, IN 47150
PHONE: 812-944-6733 FAX: 812-948-5047
e-Mail info@SAMTEC.com code 55322

DO NOT SCALE DRAWING

DESCRIPTION: BOARD TO BOARD STANDOFF

DWG. NO. SO-XXXX-XX-XX-XX-X

SHEET SCALE: 3:1

BY: T.NEWTON 12/6/2007 SHEET 3 OF 7

-04 LEAD STYLE

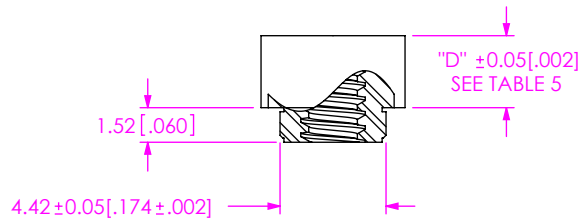
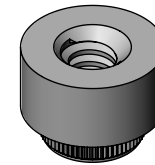
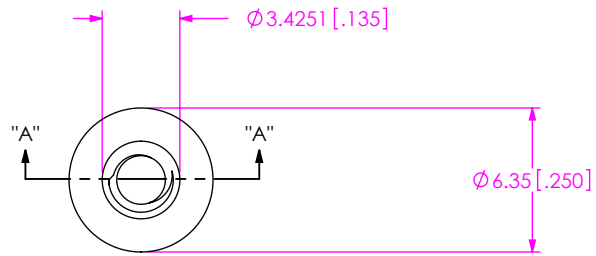
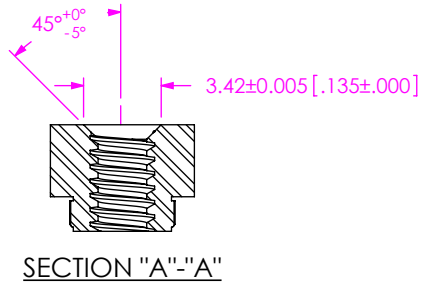
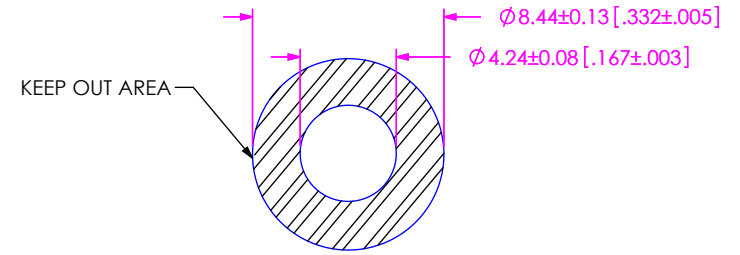

FIG 4
SO-XXXX-04-01-02 SHOWN



RECOMMENDED BOARD
CUTOUT (PRESS-IN)

TABLE 5	
04 LEAD STYLE AVAILABILITY	
BOARD STACK HEIGHT	"D"
-0165	1.65[.065]
-0175	1.75[.069]
-0310	3.10[.122]
-0318	3.18[.125]

<p>PROPRIETARY NOTE</p> <p>THIS DOCUMENT CONTAINS CONFIDENTIAL AND PROPRIETARY INFORMATION AND ALL DESIGN, MANUFACTURING, REPRODUCTION, USE, PATENT RIGHTS AND SALES RIGHTS ARE EXPRESSLY RESERVED BY SAMTEC, INC. THIS DOCUMENT SHALL NOT BE DISCLOSED, IN WHOLE OR PART, TO ANY UNAUTHORIZED PERSON OR ENTITY NOR REPRODUCED, TRANSFERRED OR INCORPORATED IN ANY OTHER PROJECT IN ANY MANNER WITHOUT THE EXPRESS WRITTEN CONSENT OF SAMTEC, INC.</p>	<p>520 PARK EAST BLVD, NEW ALBANY, IN 47150 PHONE: 812-944-6733 FAX: 812-948-5047 e-Mail info@SAMTEC.com code 55322</p>	
	<p>DO NOT SCALE DRAWING</p>	<p>DESCRIPTION: BOARD TO BOARD STANDOFF</p>
<p>SHEET SCALE: 1:0.333333</p>	<p>BY: T.NEWTON 12/6/2007</p>	<p>SHEET 4 OF 7</p>

-05 LEAD STYLE

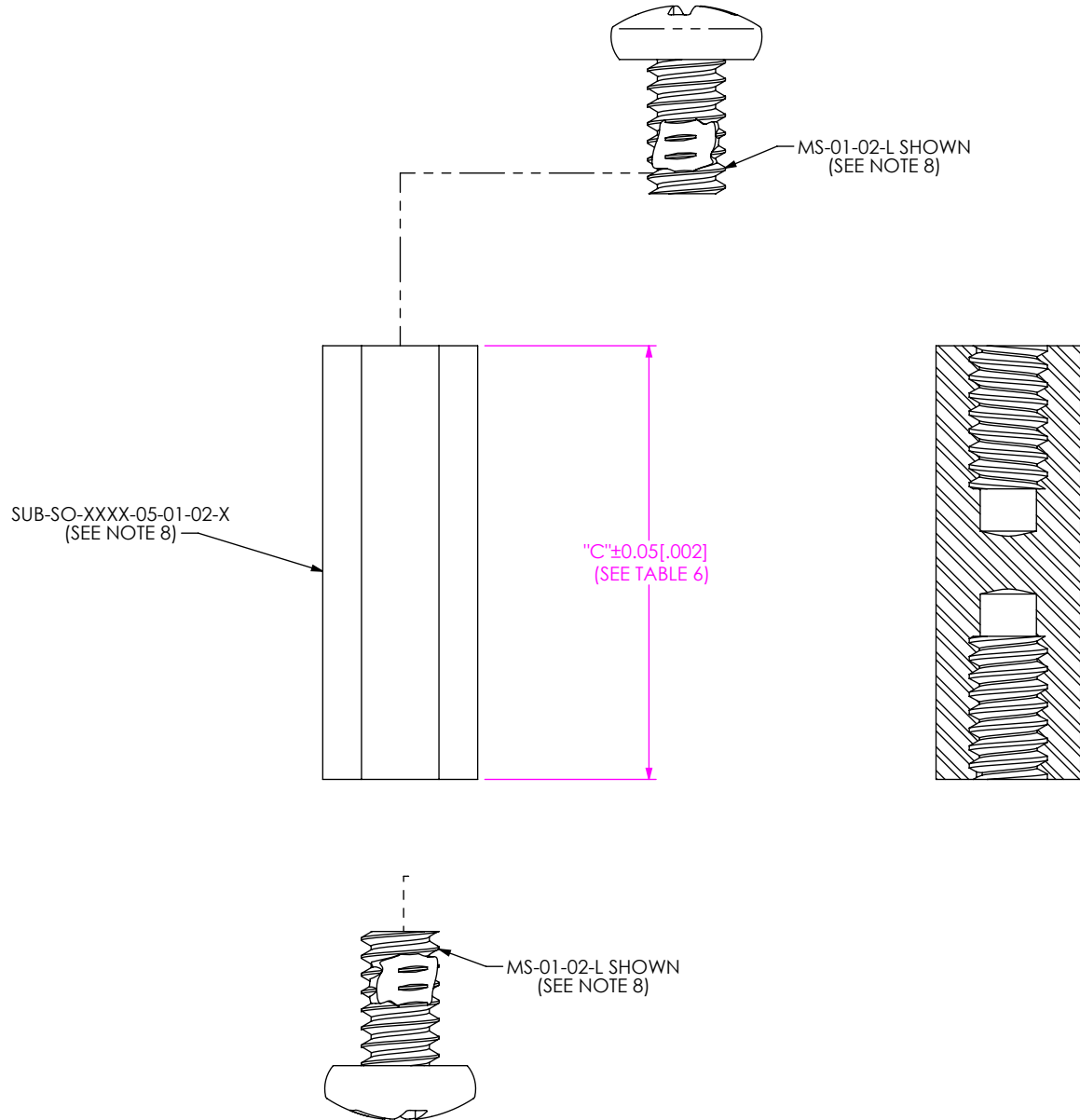
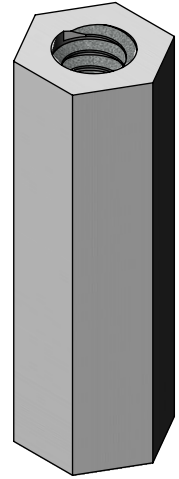

TABLE 6	
05 LEAD STYLE AVAILABILITY	
BOARD STACK HEIGHT	"C"
-0515	5.15[.002]
-0915	9.15[.004]
-1015	10.15[.400]
-1115	11.15[.440]
-1215	12.15[.492]
-1315	13.15[.518]
-1415	14.15[.557]
-1515	15.15[.597]
-1524	15.24[.600]
-1615	16.15[.636]
-1715	17.15[.675]
-1890	18.90[.744]
-1915	19.15[.754]
-2015	20.15[.793]
-2200	22.00[.866]
-2215	22.15[.872]
-2515	25.15[.990]

FIG 5
SO-XXXX-05-01-02-X SHOWN
(SAME AS -02 LEAD STYLE,
EXCEPT WHERE STATED)

PROPRIETARY NOTE
THIS DOCUMENT CONTAINS CONFIDENTIAL AND PROPRIETARY INFORMATION AND ALL DESIGN, MANUFACTURING, REPRODUCTION, USE, PATENT RIGHTS AND SALES RIGHTS ARE EXPRESSLY RESERVED BY SAMTEC, INC. THIS DOCUMENT SHALL NOT BE DISCLOSED, IN WHOLE OR PART, TO ANY UNAUTHORIZED PERSON OR ENTITY NOR REPRODUCED, TRANSFERRED OR INCORPORATED IN ANY OTHER PROJECT IN ANY MANNER WITHOUT THE EXPRESS WRITTEN CONSENT OF SAMTEC, INC.



520 PARK EAST BLVD, NEW ALBANY, IN 47150
PHONE: 812-944-6733 FAX: 812-948-5047
e-Mail info@SAMTEC.com code 55322

DO NOT SCALE DRAWING

DESCRIPTION: BOARD TO BOARD STANDOFF

DWG. NO. SO-XXXX-XX-XX-XX-X

SHEET SCALE: 1:1

BY: T.NEWTON 12/6/2007 SHEET 5 OF 7

-06 LEAD STYLE

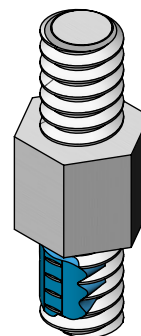
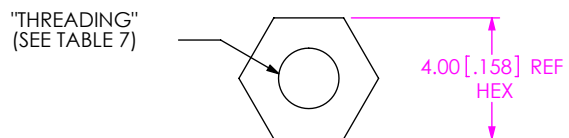
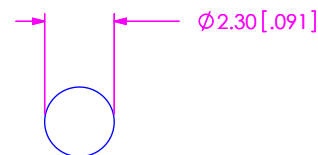
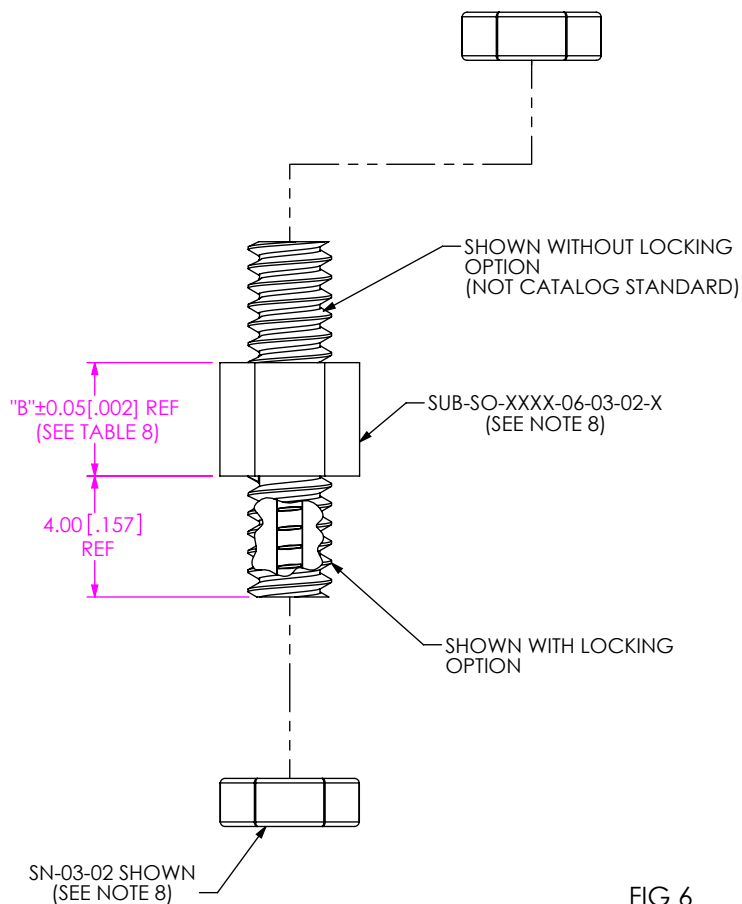

TABLE 8	
06 LEAD STYLE AVAILABILITY	
BOARD STACK HEIGHT	"B"
-0375	3.75 [.148]



RECOMMENDED BOARD CUTOUT (M2 x 0.4)

FIG 6
SO-XXXX-06-03-02-X SHOWN
(SAME AS -02 LEAD STYLE,
EXCEPT WHERE STATED)

PROPRIETARY NOTE
THIS DOCUMENT CONTAINS CONFIDENTIAL AND PROPRIETARY INFORMATION AND ALL DESIGN, MANUFACTURING, REPRODUCTION, USE, PATENT RIGHTS AND SALES RIGHTS ARE EXPRESSLY RESERVED BY SAMTEC, INC. THIS DOCUMENT SHALL NOT BE DISCLOSED, IN WHOLE OR PART, TO ANY UNAUTHORIZED PERSON OR ENTITY NOR REPRODUCED, TRANSFERRED OR INCORPORATED IN ANY OTHER PROJECT IN ANY MANNER WITHOUT THE EXPRESS WRITTEN CONSENT OF SAMTEC, INC.



520 PARK EAST BLVD, NEW ALBANY, IN 47150
PHONE: 812-944-6733 FAX: 812-948-5047
e-Mail info@SAMTEC.com code 55322

DO NOT SCALE DRAWING

DESCRIPTION: BOARD TO BOARD STANDOFF

DWG. NO. SO-XXXX-XX-XX-XX-X

SHEET SCALE: 4:1

BY: T.NEWTON 12/6/2007 SHEET 6 OF 7

TABLE 2 - BOM

FINISHED GOOD	STANDOFF	QTY	SCREW	QTY	NUT	QTY
SO-XXXX-01-01-XX	SUB-SO-XXXX-01-01-XX	1	MS-01-XX	1	N/A	
SO-XXXX-01-01-XX-N	SUB-SO-XXXX-01-01-XX	1	N/A		N/A	
SO-XXXX-01-01-XX-L	SUB-SO-XXXX-01-01-XX	1	MS-01-XX-L	1	N/A	
SO-XXXX-02-01-XX	SUB-SO-XXXX-02-01-XX	1	N/A		SN-01-XX	2
SO-XXXX-02-01-XX-N	SUB-SO-XXXX-02-01-XX	1	N/A		N/A	
SO-XXXX-02-01-XX-L	SUB-SO-XXXX-02-01-XX-L	1	N/A		SN-01-XX	2
SO-XXXX-02-01-XX-L-N	SUB-SO-XXXX-02-01-XX-L	1	N/A		N/A	
SO-XXXX-03-01-XX	SUB-SO-XXXX-03-01-XX	1	MS-01-XX	1	SN-01-XX	1
SO-XXXX-03-01-XX-N	SUB-SO-XXXX-03-01-XX	1	N/A		N/A	
SO-XXXX-03-01-XX-L	SUB-SO-XXXX-03-01-XX-L	1	MS-01-XX-L	1	SN-01-XX	1
SO-XXXX-03-01-XX-L-N	SUB-SO-XXXX-03-01-XX-L	1	N/A		N/A	
SO-XXXX-05-01-XX	SUB-SO-XXXX-05-01-XX	1	MS-01-XX	2	N/A	
SO-XXXX-05-01-XX-N	SUB-SO-XXXX-05-01-XX	1	N/A		N/A	
SO-XXX-05-01-XX-L	SUB-SO-XXX-05-01-XX	1	MS-01-XX-L	2	N/A	
SO-XXXX-01-02-XX	SUB-SO-XXXX-01-02-XX	1	MS-02-XX	1	N/A	
SO-XXXX-01-02-XX-N	SUB-SO-XXXX-01-02-XX	1	N/A		N/A	
SO-XXXX-01-02-XX-L	SUB-SO-XXXX-01-02-XX	1	MS-02-XX-L	1	N/A	
SO-XXXX-02-02-XX	SUB-SO-XXXX-02-02-XX	1	N/A		SN-02-XX	2
SO-XXXX-02-02-XX-N	SUB-SO-XXXX-02-02-XX	1	N/A		N/A	
SO-XXXX-02-02-XX-L	SUB-SO-XXXX-02-02-XX-L	1	N/A		SN-02-XX	2
SO-XXXX-02-02-XX-L-N	SUB-SO-XXXX-02-02-XX-L	1	N/A		N/A	
SO-XXXX-02-03-XX-L	SUB-SO-XXXX-02-03-XX-L	1	N/A		SN-03-XX	2
SO-XXXX-03-02-XX	SUB-SO-XXXX-03-02-XX	1	MS-02-XX	1	SN-02-XX	1
SO-XXXX-03-02-XX-N	SUB-SO-XXXX-03-02-XX	1	N/A		N/A	
SO-XXXX-03-02-XX-L	SUB-SO-XXXX-03-02-XX-L	1	MS-02-XX-L	1	SN-02-XX	1
SO-XXXX-03-02-XX-L-N	SUB-SO-XXXX-03-02-XX-L	1	N/A		N/A	
SO-XXXX-03-03-XX	SUB-SO-XXXX-03-03-XX	1	MS-06-XX	1	SN-03-XX	1
SO-XXXX-03-03-XX-N	SUB-SO-XXXX-03-03-XX	1	N/A		N/A	
SO-XXXX-03-03-XX-L	SUB-SO-XXXX-03-03-XX-L	1	MS-06-XX-L	1	SN-03-XX	1
SO-XXXX-03-03-XX-L-N	SUB-SO-XXXX-03-03-XX-L	1	N/A		N/A	
SO-XXXX-05-02-XX	SUB-SO-XXXX-05-02-XX	1	MS-02-XX	2	N/A	
SO-XXXX-05-02-XX-N	SUB-SO-XXXX-05-02-XX	1	N/A		N/A	
SO-XXX-05-02-XX-L	SUB-SO-XXX-05-02-XX	1	MS-02-XX-L	2	N/A	
SO-XXX-05-03-XX	SUB-SO-XXX-05-03-XX	1	MS-06-XX	2	N/A	
SO-XXX-05-03-XX-L	SUB-SO-XXX-05-03-XX	1	MS-06-XX-L	2	N/A	
SO-XXXX-01-03-XX	SUB-SO-XXXX-01-03-XX	1	MS-06-XX	1	N/A	

PROPRIETARY NOTE
 THIS DOCUMENT CONTAINS CONFIDENTIAL AND PROPRIETARY INFORMATION AND ALL DESIGN, MANUFACTURING, REPRODUCTION, USE, PATENT RIGHTS AND SALES RIGHTS ARE EXPRESSLY RESERVED BY SAMTEC, INC. THIS DOCUMENT SHALL NOT BE DISCLOSED, IN WHOLE OR PART, TO ANY UNAUTHORIZED PERSON OR ENTITY NOR REPRODUCED, TRANSFERRED OR INCORPORATED IN ANY OTHER PROJECT IN ANY MANNER WITHOUT THE EXPRESS WRITTEN CONSENT OF SAMTEC, INC.



520 PARK EAST BLVD, NEW ALBANY, IN 47150
 PHONE: 812-944-6733 FAX: 812-948-5047
 e-Mail info@SAMTEC.com code 55322

DO NOT SCALE DRAWING

DESCRIPTION:
 BOARD TO BOARD STANDOFF

DWG. NO.
SO-XXXX-XX-XX-XX-X

SHEET SCALE: 4:1

BY: T.NEWTON 12/6/2007 SHEET 7 OF 7