

SN74GTLP22033

8-BIT LVTTTL-TO-GTLP ADJUSTABLE-EDGE-RATE REGISTERED TRANSCEIVER WITH SPLIT LVTTTL PORT AND FEEDBACK PATH

SCES354C – JUNE 2001 – REVISED SEPTEMBER 2001

- Member of the Texas Instruments Widebus™ Family
- TI-OPC™ Circuitry Limits Ringing on Unevenly Loaded Backplanes
- OEC™ Circuitry Improves Signal Integrity and Reduces Electromagnetic Interference
- Bidirectional Interface Between GTLP Signal Levels and LVTTTL Logic Levels
- Split LVTTTL Port Provides a Feedback Path for Control and Diagnostics Monitoring
- AO Outputs Have Equivalent 26-Ω Series Resistors, So No External Resistors Are Required
- LVTTTL Interfaces Are 5-V Tolerant
- High-Drive GTLP Open-Drain Outputs (100 mA)
- Reduced LVTTTL Outputs (–12 mA/12 mA)
- Variable Edge-Rate Control (ERC) Input Selects GTLP Rise and Fall Times for Optimal Data-Transfer Rate and Signal Integrity in Distributed Loads
- I_{off}, Power-Up 3-State, and BIAS V_{CC} Support Live Insertion
- Distributed V_{CC} and GND Pins Minimize High-Speed Switching Noise
- Latch-Up Performance Exceeds 100 mA Per JESD 78, Class II
- ESD Protection Exceeds JESD 22
 - 2000-V Human-Body Model (A114-A)
 - 200-V Machine Model (A115-A)
 - 1000-V Charged-Device Model (C101)

DGG OR DGV PACKAGE
(TOP VIEW)

IMODE1	1	48	IMODE0
A11	2	47	BIAS V _{CC}
AO1	3	46	B1
GND	4	45	GND
A12	5	44	OEAB
AO2	6	43	B2
V _{CC}	7	42	ERC
A13	8	41	OEAB
AO3	9	40	B3
GND	10	39	GND
A14	11	38	CLKAB/LEAB
AO4	12	37	B4
AO5	13	36	B5
A15	14	35	CLKBA/LEBA
GND	15	34	GND
AO6	16	33	B6
A16	17	32	OEBA
V _{CC}	18	31	V _{CC}
AO7	19	30	B7
A17	20	29	LOOPBACK
GND	21	28	GND
AO8	22	27	B8
A18	23	26	V _{REF}
OMODE0	24	25	OMODE1

description

The SN74GTLP22033 is a high-drive, 8-bit, three-wire registered transceiver that provides inverted LVTTTL-to-GTLP and GTLP-to-LVTTTL signal-level translation. The device allows for transparent, latched, and flip-flop modes of data transfer with separate LVTTTL input and LVTTTL output pins, which provides a feedback path for control and diagnostics monitoring, the same functionality as the SN74FB2033. The device provides a high-speed interface between cards operating at LVTTTL logic levels and a backplane operating at GTLP signal levels. High-speed (about three times faster than standard LVTTTL or TTL) backplane operation is a direct result of GTLP's reduced output swing (<1 V), reduced input threshold levels, improved differential input, OEC™ circuitry, and TI-OPC™ circuitry. Improved GTLP OEC and TI-OPC circuits minimize bus-settling time and have been designed and tested using several backplane models. The high drive allows incident-wave switching in heavily loaded backplanes with equivalent load impedance down to 11 Ω.

The AO outputs, which are designed to sink up to 12 mA, include equivalent 26-Ω resistors to reduce overshoot and undershoot.



Please be aware that an important notice concerning availability, standard warranty, and use in critical applications of Texas Instruments semiconductor products and disclaimers thereto appears at the end of this data sheet.

OEC, TI-OPC, and Widebus are trademarks of Texas Instruments.

PRODUCTION DATA information is current as of publication date. Products conform to specifications per the terms of Texas Instruments standard warranty. Production processing does not necessarily include testing of all parameters.



Copyright © 2001, Texas Instruments Incorporated

SN74GTLP22033

8-BIT LVTTTL-TO-GTLP ADJUSTABLE-EDGE-RATE REGISTERED TRANSCEIVER WITH SPLIT LVTTTL PORT AND FEEDBACK PATH

SCES354C – JUNE 2001 – REVISED SEPTEMBER 2001

description (continued)

GTLP is the Texas Instruments derivative of the Gunning Transceiver Logic (GTL) JEDEC standard JESD 8-3. The ac specification of the SN74GTLP22033 is given only at the preferred higher noise margin GTLP, but the user has the flexibility of using this device at either GTL ($V_{TT} = 1.2\text{ V}$ and $V_{REF} = 0.8\text{ V}$) or GTLP ($V_{TT} = 1.5\text{ V}$ and $V_{REF} = 1\text{ V}$) signal levels. For information on using GTLP devices in FB+/BTL applications, refer to TI application reports, *Texas Instruments GTLP Frequently Asked Questions*, literature number SCEA019, and *GTLP in BTL Applications*, literature number SCEA017.

Normally, the B port operates at GTLP signal levels. The A-port and control inputs operate at LVTTTL logic levels, but are 5-V tolerant and can be directly driven by TTL or 5-V CMOS devices. V_{REF} is the B-port differential input reference voltage.

This device is fully specified for live-insertion applications using I_{off} , power-up 3-state, and BIAS V_{CC} . The I_{off} circuitry disables the outputs, preventing damaging current backflow through the device when it is powered down. The power-up 3-state circuitry places the outputs in the high-impedance state during power up and power down, which prevents driver conflict. The BIAS V_{CC} circuitry precharges and preconditions the B-port input/output connections, preventing disturbance of active data on the backplane during card insertion or removal, and permits true live-insertion capability.

This GTLP device features TI-OPC circuitry, which actively limits overshoot caused by improperly terminated backplanes, unevenly distributed cards, or empty slots during low-to-high signal transitions. This improves signal integrity, which allows adequate noise margin to be maintained at higher frequencies.

High-drive GTLP backplane interface devices feature adjustable edge-rate control (ERC). Changing the ERC input voltage between low and high adjusts the B-port output rise and fall times. This allows the designer to optimize system data-transfer rate and signal integrity to the backplane load.

When V_{CC} is between 0 and 1.5 V, the device is in the high-impedance state during power up or power down. However, to ensure the high-impedance state above 1.5 V, \overline{OEAB} should be tied to V_{CC} through a pullup resistor and OEAB and OEBA should be tied to GND through a pulldown resistor; the minimum value of the resistor is determined by the current-sinking/current-sourcing capability of the driver.

**GQL PACKAGE
(TOP VIEW)**

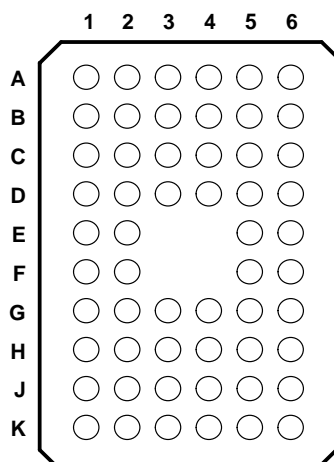

terminal assignments

	1	2	3	4	5	6
A	IMODE1	NC	NC	NC	NC	IMODE0
B	AO1	AI1	GND	GND	BIAS V_{CC}	B1
C	AO2	AI2	V_{CC}	ERC	OEAB	B2
D	AO3	AI3	GND	GND	\overline{OEAB}	B3
E	AO4	AI4			CLKAB/LEAB	B4
F	AO5	AI5			CLKBA/LEBA	B5
G	AO6	AI6	GND	GND	OEBA	B6
H	AO7	AI7	V_{CC}	V_{CC}	LOOPBACK	B7
J	AO8	AI8	GND	GND	V_{REF}	B8
K	OMODE0	NC	NC	NC	NC	OMODE1

NC = No internal connection



SN74GTLP22033

**8-BIT LVTTTL-TO-GTLP ADJUSTABLE-EDGE-RATE REGISTERED TRANSCEIVER
WITH SPLIT LVTTTL PORT AND FEEDBACK PATH**

SCES354C – JUNE 2001 – REVISED SEPTEMBER 2001

ORDERING INFORMATION

T _A	PACKAGE†		ORDERABLE PART NUMBER	TOP-SIDE MARKING
–40°C to 85°C	TSSOP – DGG	Tape and reel	SN74GTLP22033DGGR	GTLP22033
	TVSOP – DGV	Tape and reel	SN74GTLP22033DGVR	GT22033
	VFBGA – GQL	Tape and reel	SN74GTLP22033GQLR	GS033

† Package drawings, standard packing quantities, thermal data, symbolization, and PCB design guidelines are available at www.ti.com/sc/package.

functional description

The SN74GTLP22033 is a high-drive (100 mA), 8-bit, three-wire registered transceiver containing D-type latches and D-type flip-flops for data-path operation in the transparent, latched, or flip-flop modes. Data transmission is complementary, with inverted AI data going to the B port and inverted B data going to AO. The split LVTTTL AI and AO provides a feedback path for control and diagnostics monitoring.

The logic element for data flow in each direction is configured by two mode (IMODE1 and IMODE0 for B to A, OMODE1 and OMODE0 for A to B) inputs as a buffer, a D-type flip-flop, or a D-type latch. When configured in the buffer mode, the inverted input data appears at the output port. In the flip-flop mode, data is stored on the rising edge of the appropriate clock (CLKAB/LEAB or CLKBA/LEBA) input. In the latch mode, the clock inputs serve as active-high transparent latch enables.

Data flow in the B-to-A direction, regardless of the logic element selected, is further controlled by the LOOPBACK input. When LOOPBACK is low, B-port data is the B-to-A input. When LOOPBACK is high, the output of the selected A-to-B logic element (prior to inversion) is the B-to-A input.

The AO enable/disable control is provided by OEBA. When OEBA is low or when V_{CC} is less than 1.5 V, AO is in the high-impedance state. When OEBA is high, AO is active (high or low logic levels).

The B port is controlled by OEAB and \overline{OEAB} . If OEAB is low, \overline{OEAB} is high, or V_{CC} is less than 1.5 V, the B port is inactive. If OEAB is high and \overline{OEAB} is low, the B port is active.

The A-to-B and B-to-A logic elements are active, regardless of the state of their associated outputs. The logic elements can enter new data (in flip-flop and latch modes) or retain previously stored data while the associated outputs are in the high-impedance (AO) or inactive (B port) states.



8-BIT LVTTTL-TO-GTLP ADJUSTABLE-EDGE-RATE REGISTERED TRANSCEIVER WITH SPLIT LVTTTL PORT AND FEEDBACK PATH

SCES354C – JUNE 2001 – REVISED SEPTEMBER 2001

Function Tables

FUNCTION/MODE

INPUTS								OUTPUT	MODE
OEBA	OEAB	\overline{OEAB}	OMODE1	OMODE0	IMODE1	IMODE0	LOOPBACK		
L	L	X	X	X	X	X	X	Z	Isolation
L	X	H	X	X	X	X	X	Z	Isolation
X	H	L	L	L	X	X	X	Inverted A1 to B	Buffer
X	H	L	L	H	X	X	X	Inverted A1 to B	Flip-flop
X	H	L	H	X	X	X	X	Inverted A1 to B	Latch
H	L	X	X	X	L	L	L	Inverted B to AO	Buffer
H	X	H	X	X	L	L	L	Inverted B to AO	Buffer
H	L	X	X	X	L	H	L	Inverted B to AO	Flip-flop
H	X	H	X	X	L	H	L	Inverted B to AO	Flip-flop
H	L	X	X	X	H	X	L	Inverted B to AO	Latch
H	X	H	X	X	H	X	L	Inverted B to AO	Latch
H	L	X	X	X	L	L	H	A1 to AO	Buffer
H	X	H	X	X	L	L	H	A1 to AO	Buffer
H	L	X	X	X	L	H	H	A1 to AO	Flip-flop
H	X	H	X	X	L	H	H	A1 to AO	Flip-flop
H	L	X	X	X	H	X	H	A1 to AO	Latch
H	X	H	X	X	H	X	H	A1 to AO	Latch
H	H	L	X	X	X	X	L	Inverted A1 to B, Inverted B to AO	Transparent with feedback path

ENABLE/DISABLE

INPUTS			OUTPUTS	
OEBA	OEAB	\overline{OEAB}	AO	B
L	X	X	Z	
H	X	X	Active	
X	L	L		Z
X	L	H		Z
X	H	L		Active
X	H	H		Z

BUFFER

INPUT	OUTPUT
L	H
H	L

LATCH

INPUTS		OUTPUT
CLK/LE	DATA	
H	L	H
H	H	L
L	X	Q ₀



SN74GTLP22033

**8-BIT LVTTTL-TO-GTLP ADJUSTABLE-EDGE-RATE REGISTERED TRANSCEIVER
WITH SPLIT LVTTTL PORT AND FEEDBACK PATH**

SCES354C – JUNE 2001 – REVISED SEPTEMBER 2001

Function Tables (Continued)

LOOPBACK

LOOPBACK	Q [†]
L	B port
H	Point P [‡]

† Q is the input to the B-to-A logic element.

‡ P is the output of the A-to-B logic element (see functional block diagram).

SELECT

INPUTS		SELECTED LOGIC ELEMENT
MODE1	MODE0	
L	L	Buffer
L	H	Flip-flop
H	X	Latch

FLIP-FLOP

INPUTS		OUTPUT
CLK/LE	DATA	
L	X	Q ₀
↑	L	H
↑	H	L

B-PORT EDGE-RATE CONTROL (ERC)

INPUT ERC	OUTPUT B-PORT EDGE RATE
LOGIC LEVEL	
H	Slow
L	Fast

SN74GTLP22033
8-BIT LVTTTL-TO-GTLP ADJUSTABLE-EDGE-RATE REGISTERED TRANSCEIVER
WITH SPLIT LVTTTL PORT AND FEEDBACK PATH

SCES354C – JUNE 2001 – REVISED SEPTEMBER 2001

functional block diagram

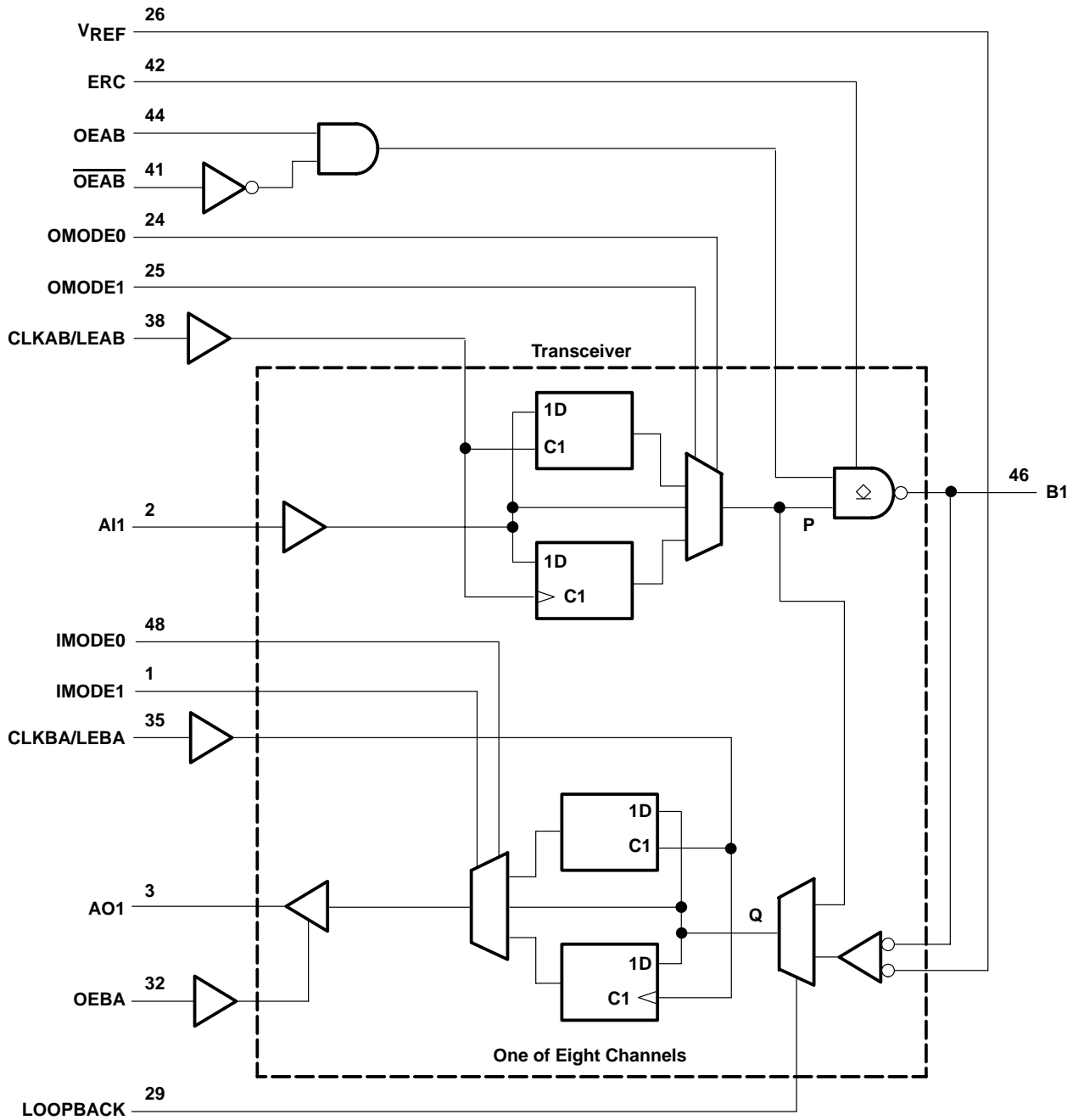

Pin numbers shown are for the DGG and DGV packages.



POST OFFICE BOX 655303 • DALLAS, TEXAS 75265

SN74GTLP22033

**8-BIT LVTTTL-TO-GTLP ADJUSTABLE-EDGE-RATE REGISTERED TRANSCEIVER
WITH SPLIT LVTTTL PORT AND FEEDBACK PATH**

SCES354C – JUNE 2001 – REVISED SEPTEMBER 2001

absolute maximum ratings over operating free-air temperature range (unless otherwise noted)†

Supply voltage range, V_{CC} and BIAS V_{CC}	-0.5 V to 4.6 V
Input voltage range, V_I (see Note 1): AI port, ERC, and control inputs	-0.5 V to 7 V
B port and V_{REF}	-0.5 V to 4.6 V
Voltage range applied to any output in the high-impedance or power-off state, V_O (see Note 1): AO port	-0.5 V to 7 V
B port	-0.5 V to 4.6 V
Current into any output in the low state, I_O : AO port	24 mA
B port	200 mA
Current into any A-port output in the high state, I_O (see Note 2)	24 mA
Continuous current through each V_{CC} or GND	± 100 mA
Input clamp current, I_{IK} ($V_I < 0$)	-50 mA
Output clamp current, I_{OK} ($V_O < 0$)	-50 mA
Package thermal impedance, θ_{JA} (see Note 3): DGG package	70°C/W
DGV package	58°C/W
GQL package	42°C/W
Storage temperature range, T_{stg}	-65°C to 150°C

† Stresses beyond those listed under “absolute maximum ratings” may cause permanent damage to the device. These are stress ratings only, and functional operation of the device at these or any other conditions beyond those indicated under “recommended operating conditions” is not implied. Exposure to absolute-maximum-rated conditions for extended periods may affect device reliability.

- NOTES: 1. The input and output negative-voltage ratings may be exceeded if the input and output clamp-current ratings are observed.
 2. This current flows only when the output is in the high state and $V_O > V_{CC}$.
 3. The package thermal impedance is calculated in accordance with JESD 51-7.



8-BIT LVTTTL-TO-GTLP ADJUSTABLE-EDGE-RATE REGISTERED TRANSCEIVER WITH SPLIT LVTTTL PORT AND FEEDBACK PATH

SCES354C – JUNE 2001 – REVISED SEPTEMBER 2001

recommended operating conditions (see Notes 4 through 7)

		MIN	NOM	MAX	UNIT	
V_{CC} , BIAS V_{CC}	Supply voltage	3.15	3.3	3.45	V	
V_{TT}	Termination voltage	GTL	1.14	1.2	1.26	V
		GTLP	1.35	1.5	1.65	
V_{REF}	Reference voltage	GTL	0.74	0.8	0.87	V
		GTLP	0.87	1	1.1	
V_I	Input voltage	B port	V_{TT}		V	
		Except B port and V_{REF}	V_{CC}	5.5		
V_{IH}	High-level input voltage	B port	$V_{REF}+0.05$		V	
		Except B port	2			
V_{IL}	Low-level input voltage	B port	$V_{REF}-0.05$		V	
		Except B port	0.8			
I_{IK}	Input clamp current			-18	mA	
I_{OH}	High-level output current	AO			-12	mA
I_{OL}	Low-level output current	AO			12	mA
		B port			100	
$\Delta t/\Delta v$	Input transition rise or fall rate	Outputs enabled		10	ns/V	
$\Delta t/\Delta V_{CC}$	Power-up ramp rate	20			μ s/V	
T_A	Operating free-air temperature	-40		85	$^{\circ}$ C	

- NOTES: 4. All unused control and B-port inputs of the device must be held at V_{CC} or GND to ensure proper device operation. Refer to the TI application report, *Implications of Slow or Floating CMOS Inputs*, literature number SCBA004.
5. Proper connection sequence for use of the B-port I/O precharge feature is GND and BIAS $V_{CC} = 3.3$ V first, I/O second, and $V_{CC} = 3.3$ V last, because the BIAS V_{CC} precharge circuitry is disabled when any V_{CC} pin is connected. The control and V_{REF} inputs can be connected anytime, but normally are connected during the I/O stage. If B-port precharge is not required, any connection sequence is acceptable but, generally, GND is connected first.
6. V_{TT} and R_{TT} can be adjusted to accommodate backplane impedances if the dc recommended I_{OL} ratings are not exceeded.
7. V_{REF} can be adjusted to optimize noise margins, but normally is two-thirds V_{TT} . TI-OPC circuitry is enabled in the A-to-B direction and is activated when $V_{TT} > 0.7$ V above V_{REF} . If operated in the A-to-B direction, V_{REF} should be set to within 0.6 V of V_{TT} to minimize current drain.

SN74GTLP22033
8-BIT LVTTTL-TO-GTLP ADJUSTABLE-EDGE-RATE REGISTERED TRANSCEIVER
WITH SPLIT LVTTTL PORT AND FEEDBACK PATH

SCES354C – JUNE 2001 – REVISED SEPTEMBER 2001

electrical characteristics over recommended operating free-air temperature range for GTLP (unless otherwise noted)

PARAMETER		TEST CONDITIONS		MIN	TYP†	MAX	UNIT
V_{IK}		$V_{CC} = 3.15\text{ V}$, $I_I = -18\text{ mA}$				-1.2	V
V_{OH}	AO	$V_{CC} = 3.15\text{ V to }3.45\text{ V}$, $I_{OH} = -100\text{ }\mu\text{A}$		$V_{CC}-0.2$			V
		$V_{CC} = 3.15\text{ V}$		2.4			
V_{OL}	AO	$V_{CC} = 3.15\text{ V to }3.45\text{ V}$, $I_{OL} = 100\text{ }\mu\text{A}$				0.2	V
		$V_{CC} = 3.15\text{ V}$		$I_{OL} = 6\text{ mA}$		0.55	
				$I_{OL} = 12\text{ mA}$		0.8	
	B port	$V_{CC} = 3.15\text{ V}$		$I_{OL} = 10\text{ mA}$		0.2	
				$I_{OL} = 64\text{ mA}$		0.4	
				$I_{OL} = 100\text{ mA}$		0.55	
I_I^\ddagger	AI and control inputs	$V_{CC} = 3.45\text{ V}$, $V_I = 0\text{ or }5.5\text{ V}$				± 10	μA
I_{OZ}^\ddagger	AO	$V_{CC} = 3.45\text{ V}$, $V_O = 0\text{ to }5.5\text{ V}$				± 10	μA
	B port	$V_{CC} = 3.45\text{ V}$, V_{REF} within 0.6 V of V_{TT} , $V_O = 0\text{ to }2.3\text{ V}$				± 10	
I_{CC}	AO or B port	$V_{CC} = 3.45\text{ V}$, $I_O = 0$, V_I (A-port or control input) = V_{CC} or GND, V_I (B port) = V_{TT} or GND		Outputs high		40	mA
				Outputs low		40	
				Outputs disabled		40	
ΔI_{CC}^\S		$V_{CC} = 3.45\text{ V}$, One AI or control input at $V_{CC} - 0.6\text{ V}$, Other AI or control inputs at V_{CC} or GND				1.5	mA
C_i	AI	$V_I = 3.15\text{ V or }0$			3.5	4.5	pF
	Control inputs				3.5	5.5	
C_o	AO	$V_O = 3.15\text{ V or }0$			5	6	pF
C_{io}	B port	$V_O = 1.5\text{ V or }0$			8.5	10	pF

† All typical values are at $V_{CC} = 3.3\text{ V}$, $T_A = 25^\circ\text{C}$.

‡ For I/O ports, the parameter I_{OZ} includes the input leakage current.

§ This is the increase in supply current for each input that is at the specified TTL voltage level rather than V_{CC} or GND.

hot-insertion specifications for A port over recommended operating free-air temperature range

PARAMETER	TEST CONDITIONS			MIN	MAX	UNIT
I_{off}	$V_{CC} = 0$,	V_I or $V_O = 0\text{ to }5.5\text{ V}$			10	μA
I_{OZPU}	$V_{CC} = 0\text{ to }1.5\text{ V}$,	$V_O = 0.5\text{ V to }3\text{ V}$,	$OEBA = V_{CC}$		± 30	μA
I_{OZPD}	$V_{CC} = 1.5\text{ V to }0$,	$V_O = 0.5\text{ V to }3\text{ V}$,	$OEBA = V_{CC}$		± 30	μA

live-insertion specifications for B port over recommended operating free-air temperature range

PARAMETER	TEST CONDITIONS			MIN	MAX	UNIT
I_{off}	$V_{CC} = 0$,	BIAS $V_{CC} = 0$,	V_I or $V_O = 0\text{ to }1.5\text{ V}$		10	μA
I_{OZPU}	$V_{CC} = 0\text{ to }1.5\text{ V}$,	BIAS $V_{CC} = 0$,	$V_O = 0.5\text{ V to }1.5\text{ V}$, $\overline{OEAB} = 0$ and $OEAB = V_{CC}$		± 30	μA
I_{OZPD}	$V_{CC} = 1.5\text{ V to }0$,	BIAS $V_{CC} = 0$,	$V_O = 0.5\text{ V to }1.5\text{ V}$, $\overline{OEAB} = 0$ and $OEAB = V_{CC}$		± 30	μA
I_{CC} (BIAS V_{CC})	$V_{CC} = 0\text{ to }3.15\text{ V}$	BIAS $V_{CC} = 3.15\text{ V to }3.45\text{ V}$, V_O (B port) = $0\text{ to }1.5\text{ V}$			5	mA
	$V_{CC} = 3.15\text{ V to }3.45\text{ V}$				10	μA
V_O	$V_{CC} = 0$,	BIAS $V_{CC} = 3.3\text{ V}$,	$I_O = 0$	0.95	1.05	V
I_O	$V_{CC} = 0$,	BIAS $V_{CC} = 3.15\text{ V to }3.45\text{ V}$,	V_O (B port) = 0.6 V	-1		μA



SN74GTLP22033

**8-BIT LVTTTL-TO-GTLP ADJUSTABLE-EDGE-RATE REGISTERED TRANSCEIVER
WITH SPLIT LVTTTL PORT AND FEEDBACK PATH**

SCES354C – JUNE 2001 – REVISED SEPTEMBER 2001

timing requirements over recommended ranges of supply voltage and operating free-air temperature, $V_{TT} = 1.5\text{ V}$ and $V_{REF} = 1\text{ V}$ for GTLP (unless otherwise noted)

		MIN	MAX	UNIT
f_{clock}	Clock frequency		175	MHz
t_w	Pulse duration	CLKAB/LEAB or CLKBA/LEBA		ns
t_{su}	Setup time	A1 before CLKAB \uparrow		1.1
		A1 before CLKBA \uparrow		1.4
		B before CLKBA \uparrow		1
		A1 before LEAB \downarrow		1.6
		A1 before LEBA \downarrow		2.1
		B before LEBA \downarrow		2.2
t_h	Hold time	A1 after CLKAB \uparrow		0.3
		A1 after CLKBA \uparrow		0.2
		B after CLKBA \uparrow		0.6
		A1 after LEAB \downarrow		0.3
		A1 after LEBA \downarrow		0
		B after LEBA \downarrow		0



SN74GTLP22033

**8-BIT LVTTTL-TO-GTLP ADJUSTABLE-EDGE-RATE REGISTERED TRANSCEIVER
WITH SPLIT LVTTTL PORT AND FEEDBACK PATH**

SCES354C – JUNE 2001 – REVISED SEPTEMBER 2001

switching characteristics over recommended ranges of supply voltage and operating free-air temperature, $V_{TT} = 1.5\text{ V}$ and $V_{REF} = 1\text{ V}$ for GTLP (see Figure 1)

PARAMETER	FROM (INPUT)	TO (OUTPUT)	EDGE RATE†	MIN	TYP‡	MAX	UNIT
f_{max}				175			MHz
t_{PLH}	AI (buffer)	B	Slow	3		7.4	ns
t_{PHL}				3		7.1	
t_{PLH}	AI (buffer)	B	Fast	2		5.9	ns
t_{PHL}				2		5.8	
t_{PLH}	B (buffer)	AO	–	1		6.1	ns
t_{PHL}				1		5.4	
t_{PLH}	LEAB (latch mode)	B	Slow	4.2		8.6	ns
t_{PHL}				3.2		7.7	
t_{PLH}	LEAB (latch mode)	B	Fast	3.2		7.6	ns
t_{PHL}				2.8		6.7	
t_{PLH}	LEAB (latch mode)	AO	–	2		7.3	ns
t_{PHL}				1.8		6.6	
t_{PLH}	LEBA (latch mode)	AO	–	1		6	ns
t_{PHL}				1		5.2	
t_{PLH}	OEAB	B	Slow	3.8		7.5	ns
t_{PHL}				3.1		7	
t_{PLH}	OEAB	B	Fast	2.5		6	ns
t_{PHL}				2.5		6	
t_{PLH}	\overline{OEAB}	B	Slow	3.5		7.5	ns
t_{PHL}				3		7.2	
t_{PLH}	\overline{OEAB}	B	Fast	2.5		6	ns
t_{PHL}				2.5		6	
t_{PZH}	OEBA	AO	–	1		5.3	ns
t_{PZL}				1		4.2	
t_{PHZ}	OEBA	AO	–	1		5.5	ns
t_{PLZ}				1		5.2	
t_{PLH}	CLKAB (flip-flop mode)	B	Slow	4.4		8.8	ns
t_{PHL}				3.6		8.1	
t_{PLH}	CLKAB (flip-flop mode)	B	Fast	3.2		7.2	ns
t_{PHL}				3.1		6.9	
t_{PLH}	CLKAB (flip-flop mode)	AO	–	2		7.5	ns
t_{PHL}				1.8		7	
t_{PLH}	CLKBA (flip-flop mode)	AO	–	1		6	ns
t_{PHL}				1		5.6	
t_{PLH}	OMODE	B	Slow	3.8		8.7	ns
t_{PHL}				3.2		8.2	
t_{PLH}	OMODE	B	Fast	2.7		7.2	ns
t_{PHL}				2.7		7.2	
t_{PLH}	IMODE	AO	–	1		6	ns
t_{PHL}				1		5.1	

† Slow (ERC = H) and Fast (ERC = L)

‡ All typical values are at $V_{CC} = 3.3\text{ V}$, $T_A = 25^\circ\text{C}$.



8-BIT LVTTTL-TO-GTLP ADJUSTABLE-EDGE-RATE REGISTERED TRANSCEIVER WITH SPLIT LVTTTL PORT AND FEEDBACK PATH

SCES354C – JUNE 2001 – REVISED SEPTEMBER 2001

switching characteristics over recommended ranges of supply voltage and operating free-air temperature, $V_{TT} = 1.5\text{ V}$ and $V_{REF} = 1\text{ V}$ for GTLP (see Figure 1) (continued)

PARAMETER	FROM (INPUT)	TO (OUTPUT)	EDGE RATE†	MIN	TYP‡	MAX	UNIT
t_{PLH}	LOOPBACK	AO	–	2.5		6.8	ns
t_{PHL}				2	5.4		
t_{PLH}	AI (loopback high)	AO	–	1		6	ns
t_{PHL}				1	5.5		
t_r	Rise time, B-port outputs (20% to 80%)		Slow	2.8		ns	
			Fast	1.5			
			Rise time, AO (10% to 90%)		5.5		
t_f	Fall time, B-port outputs (80% to 20%)		Slow	3		ns	
			Fast	1.8			
			Fall time, AO (90% to 10%)		4.5		

† Slow (ERC = H) and Fast (ERC = L)

‡ All typical values are at $V_{CC} = 3.3\text{ V}$, $T_A = 25^\circ\text{C}$.

skew characteristics over recommended ranges of supply voltage and operating free-air temperature (see Figure 1)§

PARAMETER	FROM (INPUT)	TO (OUTPUT)	EDGE RATE†	MIN	TYP‡	MAX	UNIT
$t_{sk(LH)}^{\parallel}$	AI	B	Slow	0.5		1	ns
$t_{sk(HL)}^{\parallel}$				0.5	1		
$t_{sk(LH)}^{\parallel}$	AI	B	Fast	0.4		0.9	ns
$t_{sk(HL)}^{\parallel}$				0.4	0.9		
$t_{sk(LH)}^{\parallel}$	CLKAB/LEAB	B	Slow	0.5		1	ns
$t_{sk(HL)}^{\parallel}$				0.5	1		
$t_{sk(LH)}^{\parallel}$	CLKAB/LEAB	B	Fast	0.4		0.9	ns
$t_{sk(HL)}^{\parallel}$				0.4	0.9		
$t_{sk(t)}^{\parallel}$	AI	B	Slow	1.4		2	ns
			Fast	0.6	1.4		
	CLKAB/LEAB	B	Slow	1.8		2.5	
			Fast	0.9	1.8		

† Slow (ERC = L) and Fast (ERC = H)

‡ All typical values are at $V_{CC} = 3.3\text{ V}$, $T_A = 25^\circ\text{C}$.

§ Actual skew values between the GTLP outputs could vary on the backplane due to the loading and impedance seen by the device.

¶ $t_{sk(LH)}/t_{sk(HL)}$ and $t_{sk(t)}$ – Output-to-output skew is defined as the absolute value of the difference between the actual propagation delay for all outputs with the same packaged device. The specifications are given for specific worst-case V_{CC} and temperature and apply to any outputs switching in the same direction either high to low [$t_{sk(HL)}$] or low to high [$t_{sk(LH)}$] or in opposite directions, both low to high and high to low [$t_{sk(t)}$].

SN74GTLP22033 8-BIT LVTTTL-TO-GTLP ADJUSTABLE-EDGE-RATE REGISTERED TRANSCEIVER WITH SPLIT LVTTTL PORT AND FEEDBACK PATH

SCES354C – JUNE 2001 – REVISED SEPTEMBER 2001

PARAMETER MEASUREMENT INFORMATION

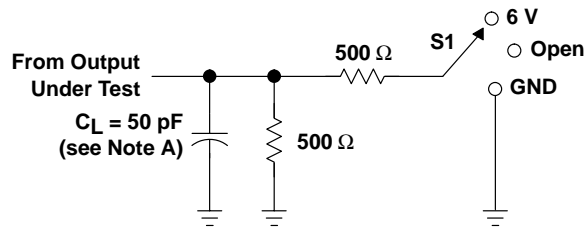

LOAD CIRCUIT FOR A OUTPUTS

TEST	S1
tPLH/tPHL	Open
tPLZ/tPZL	6 V
tPHZ/tPZH	GND

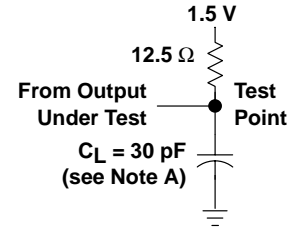

LOAD CIRCUIT FOR B OUTPUTS

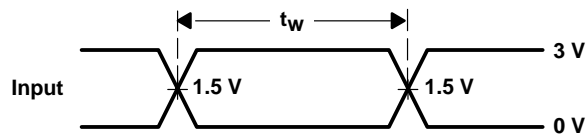

VOLTAGE WAVEFORMS
PULSE DURATION

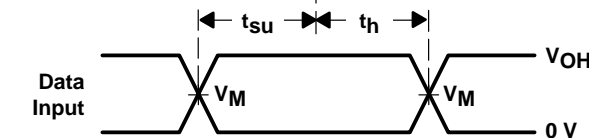
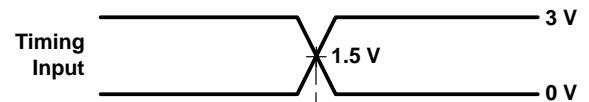

VOLTAGE WAVEFORMS
SETUP AND HOLD TIMES

(VM = 1.5 V for A port and 1 V for B port)
(VOH = 3 V for A port and 1.5 V for B port)



VOLTAGE WAVEFORMS
PROPAGATION DELAY TIMES
(A to B port)

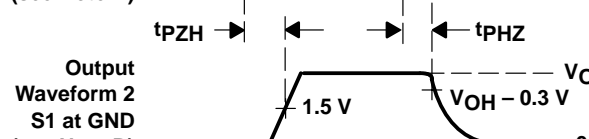
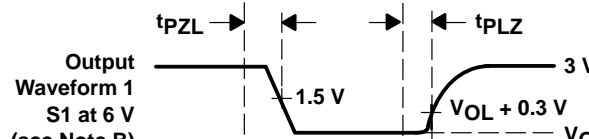
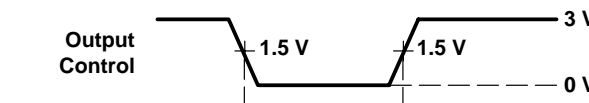

VOLTAGE WAVEFORMS
ENABLE AND DISABLE TIMES
(AO)

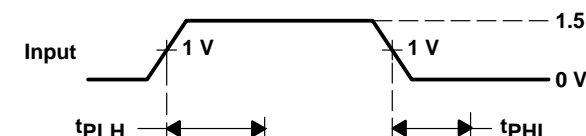

VOLTAGE WAVEFORMS
PROPAGATION DELAY TIMES
(B port to AO)

- NOTES: A. CL includes probe and jig capacitance.
 B. Waveform 1 is for an output with internal conditions such that the output is low except when disabled by the output control. Waveform 2 is for an output with internal conditions such that the output is high except when disabled by the output control.
 C. All input pulses are supplied by generators having the following characteristics: PRR = 10 MHz, ZO = 50 Ω, tr ≈ 2 ns, tf ≈ 2 ns.
 D. The outputs are measured one at a time with one transition per measurement.

Figure 1. Load Circuits and Voltage Waveforms

DISTRIBUTED-LOAD BACKPLANE SWITCHING CHARACTERISTICS

The preceding switching characteristics table shows the switching characteristics of the device into a lumped load (Figure 1). However, the designer's backplane application is probably a distributed load. The physical representation is shown in Figure 2. This backplane, or distributed load, can be closely approximated to a resistor inductance capacitance (RLC) circuit, as shown in Figure 3. This device has been designed for optimum performance in this RLC circuit. The following switching characteristics table shows the switching characteristics of the device into the RLC load, to help the designer to better understand the performance of the GTLP device in this typical backplane. See www.ti.com/sc/gtlp for more information.

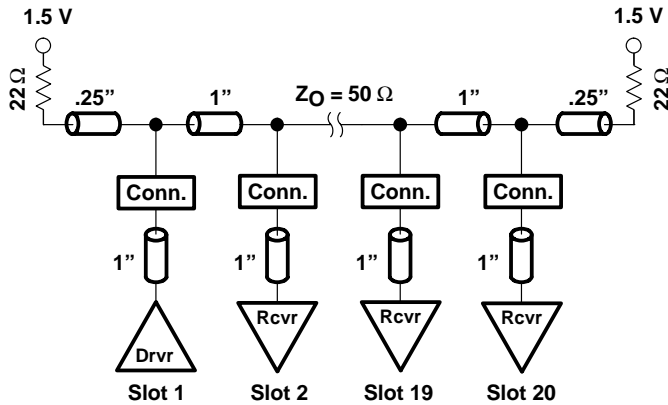

Figure 2. High-Drive Test Backplane

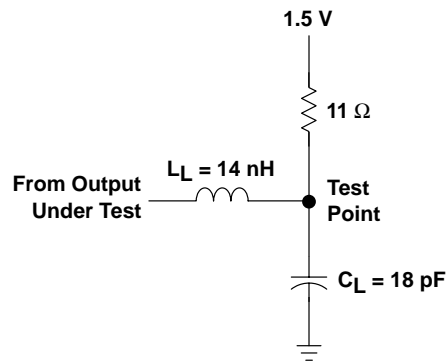

Figure 3. High-Drive RLC Network

SN74GTLP22033

**8-BIT LVTTTL-TO-GTLP ADJUSTABLE-EDGE-RATE REGISTERED TRANSCEIVER
WITH SPLIT LVTTTL PORT AND FEEDBACK PATH**

SCES354C – JUNE 2001 – REVISED SEPTEMBER 2001

switching characteristics over recommended operating conditions for the bus transceiver function (unless otherwise noted) (see Figure 3)

PARAMETER	FROM (INPUT)	TO (OUTPUT)	EDGE RATE†	TYP‡	UNIT
t _{PLH}	AI (buffer)	B	Slow	4.7	ns
t _{PHL}				5	
t _{PLH}	AI (buffer)	B	Fast	3.7	ns
t _{PHL}				4	
t _{PLH}	LEAB (latch mode)	B	Slow	5.5	ns
t _{PHL}				5.8	
t _{PLH}	LEAB (latch mode)	B	Fast	4.6	ns
t _{PHL}				4.8	
t _{PLH}	CLKAB (flip-flop mode)	B	Slow	5.8	ns
t _{PHL}				6	
t _{PLH}	CLKAB (flip-flop mode)	B	Fast	4.9	ns
t _{PHL}				4.9	
t _{PLH}	OMODE	B	Slow	5.5	ns
t _{PHL}				5.7	
t _{PLH}	OMODE	B	Fast	4.5	ns
t _{PHL}				4.7	
t _r	Rise time, B-port outputs (20% to 80%)		Slow	1.8	ns
			Fast	1.1	
t _f	Fall time, B-port outputs (80% to 20%)		Slow	3.4	ns
			Fast	2.6	

† Slow (ERC = H) and Fast (ERC = L)

‡ All typical values are at V_{CC} = 3.3 V, T_A = 25°C. All values are derived from TI-SPICE models.

DGV (R-PDSO-G**)

PLASTIC SMALL-OUTLINE

24 PINS SHOWN



- NOTES: A. All linear dimensions are in millimeters.
 B. This drawing is subject to change without notice.
 C. Body dimensions do not include mold flash or protrusion, not to exceed 0,15 per side.
 D. Falls within JEDEC: 24/48 Pins – MO-153
 14/16/20/56 Pins – MO-194

GQL (R-PBGA-N56)

PLASTIC BALL GRID ARRAY

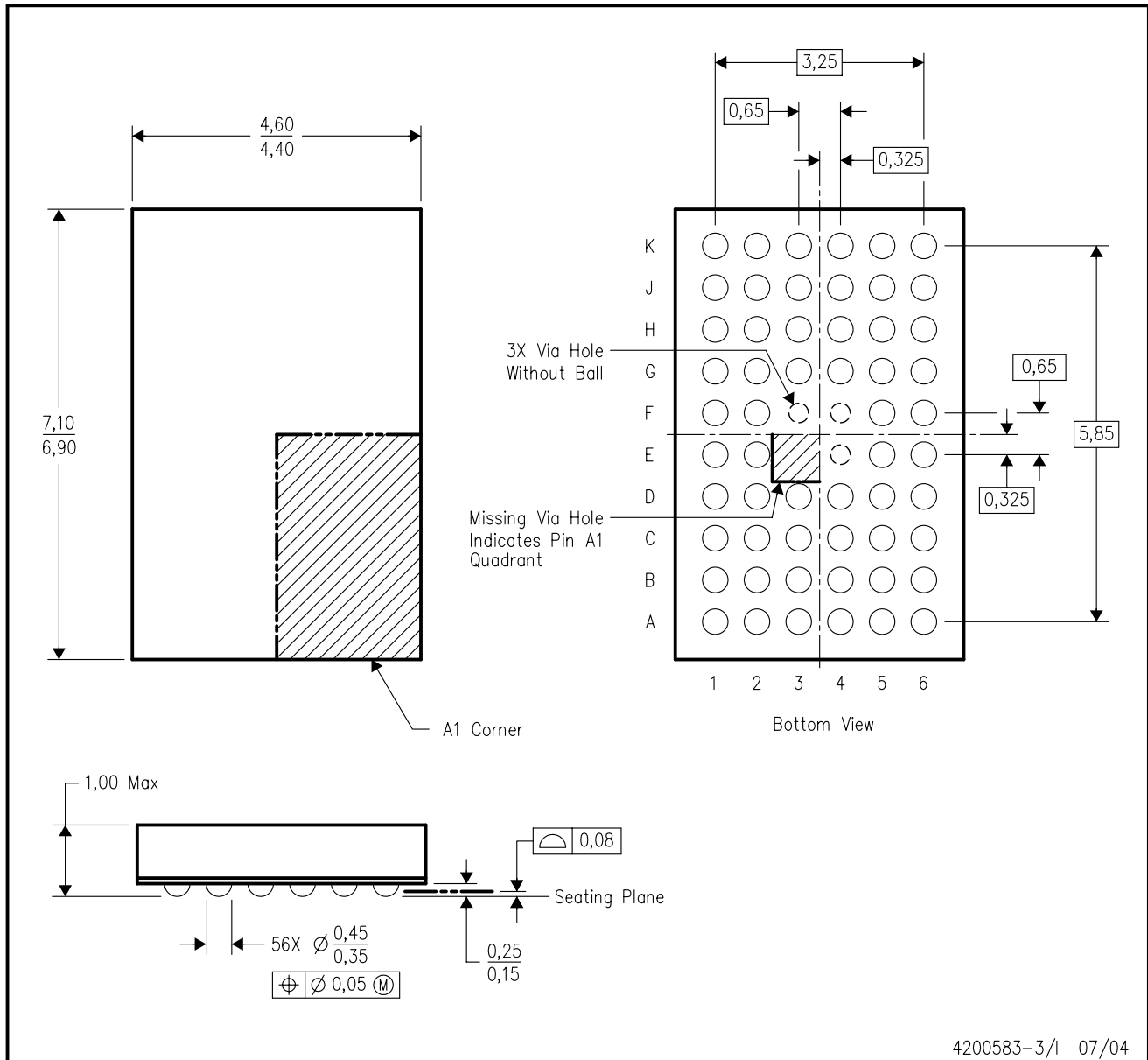

- NOTES:
- A. All linear dimensions are in millimeters.
 - B. This drawing is subject to change without notice.
 - C. Falls within JEDEC MO-225 variation BA.
 - D. This package is tin-lead (SnPb). Refer to the 56 ZQL package (drawing 4204437) for lead-free.

DGG (R-PDSO-G**)

PLASTIC SMALL-OUTLINE PACKAGE

48 PINS SHOWN



- NOTES: A. All linear dimensions are in millimeters.
 B. This drawing is subject to change without notice.
 C. Body dimensions do not include mold protrusion not to exceed 0,15.
 D. Falls within JEDEC MO-153

IMPORTANT NOTICE

Texas Instruments Incorporated and its subsidiaries (TI) reserve the right to make corrections, modifications, enhancements, improvements, and other changes to its products and services at any time and to discontinue any product or service without notice. Customers should obtain the latest relevant information before placing orders and should verify that such information is current and complete. All products are sold subject to TI's terms and conditions of sale supplied at the time of order acknowledgment.

TI warrants performance of its hardware products to the specifications applicable at the time of sale in accordance with TI's standard warranty. Testing and other quality control techniques are used to the extent TI deems necessary to support this warranty. Except where mandated by government requirements, testing of all parameters of each product is not necessarily performed.

TI assumes no liability for applications assistance or customer product design. Customers are responsible for their products and applications using TI components. To minimize the risks associated with customer products and applications, customers should provide adequate design and operating safeguards.

TI does not warrant or represent that any license, either express or implied, is granted under any TI patent right, copyright, mask work right, or other TI intellectual property right relating to any combination, machine, or process in which TI products or services are used. Information published by TI regarding third-party products or services does not constitute a license from TI to use such products or services or a warranty or endorsement thereof. Use of such information may require a license from a third party under the patents or other intellectual property of the third party, or a license from TI under the patents or other intellectual property of TI.

Reproduction of information in TI data books or data sheets is permissible only if reproduction is without alteration and is accompanied by all associated warranties, conditions, limitations, and notices. Reproduction of this information with alteration is an unfair and deceptive business practice. TI is not responsible or liable for such altered documentation.

Resale of TI products or services with statements different from or beyond the parameters stated by TI for that product or service voids all express and any implied warranties for the associated TI product or service and is an unfair and deceptive business practice. TI is not responsible or liable for any such statements.

Following are URLs where you can obtain information on other Texas Instruments products and application solutions:

Products		Applications	
Amplifiers	amplifier.ti.com	Audio	www.ti.com/audio
Data Converters	dataconverter.ti.com	Automotive	www.ti.com/automotive
DSP	dsp.ti.com	Broadband	www.ti.com/broadband
Interface	interface.ti.com	Digital Control	www.ti.com/digitalcontrol
Logic	logic.ti.com	Military	www.ti.com/military
Power Mgmt	power.ti.com	Optical Networking	www.ti.com/opticalnetwork
Microcontrollers	microcontroller.ti.com	Security	www.ti.com/security
		Telephony	www.ti.com/telephony
		Video & Imaging	www.ti.com/video
		Wireless	www.ti.com/wireless

Mailing Address: Texas Instruments
Post Office Box 655303 Dallas, Texas 75265