

SUMMARY



Image is for illustrative purpose only

Wires

Low	0
High	0
Coax	0
Triax	0
Quad	0
Fiber	0
Fluidic	0

Download

[Request a quote](#)

[Catalog](#)

Series	SP
Termination type	
IP rating	50
Cable Ø	0.00 - 0.00 mm
Matching parts	SAP.M04.GLA.6G
Status	active
Alternative part	

TECHNICAL DETAILS

Mechanics

Shell Style/Model	SK_.SP*: Fixed socket, key (N) or keys (P, S and T),grey, with two nuts (back panel mounting)
Keying	3 keys (alpha=0, gamma=60, plug: male contacts, receptacle: female contacts)
Housing Material	Proprietary sulfone, gray
Cable Fixing	∅ 0 - 0 mm
Variant	G : Gray front nut

Performance

Configuration	
Insulator	
Rated Current	11.5 Amps

Specifications

Test voltage (kV rms) Contact-contact:	1.60
Air clearance min. (mm) or Creepage distance min. (mm):	0.95

LEMO products and services are provided "as is". LEMO makes no warranties or representations with regard to LEMO product & services or use of them, express, implied or statutory, including for accuracy, completeness, or security. The user is fully responsible for his products and applications using LEMO components.

Others

IP Rating: 50

DRAWINGS

Draws

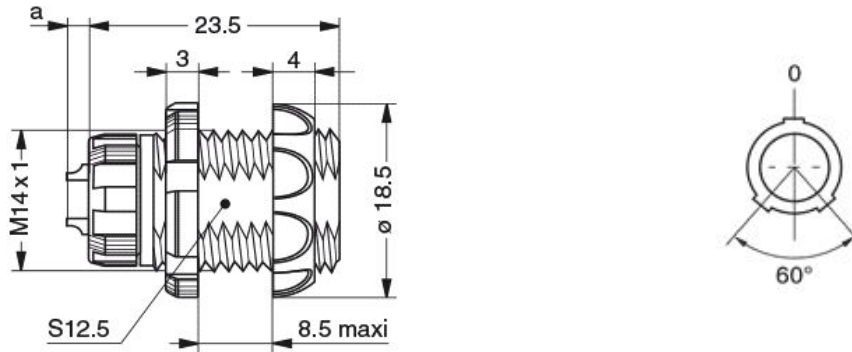

Dimensions

	B	E _{max}	N	a	e
mm.	18.5	8.5	23.5	2.2	M14x1
in.	0,73	0,33	0,93	0,09	

RECOMMENDED BY LEMO

Tools

None

Cables

121 221			
131 221			
151 221			
161 221			

LEMO products and services are provided "as is". LEMO makes no warranties or representations with regard to LEMO product & services or use of them, express, implied or statutory, including for accuracy, completeness, or security. The user is fully responsible for his products and applications using LEMO components.