

## 5mm Infrared LED SIR333-A



### Features

- High reliability
- High radiant intensity
- Peak wavelength  $\lambda_p=875\text{nm}$
- 2.54mm Lead spacing
- Low forward voltage
- Pb Free
- This product itself will remain within RoHS compliant version.
- Compliance with EU REACH
- Compliance Halogen Free(Br < 900ppm, Cl < 900ppm, Br+Cl < 1500ppm)

### Description

- EVERLIGHT's Infrared Emitting Diode (SIR333-A) is a high intensity diode , molded in Blue plastic package.
- The device is spectrally matched with phototransistor , photodiode and infrared receiver module.

### Applications

- Free air transmission system
- Infrared remote control units with high power requirement
- Smoke detector
- Infrared applied system

## Device Selection Guide

|                |            |
|----------------|------------|
| Chip Materials | Lens Color |
| GaAlAs         | Blue       |

## Absolute Maximum Ratings (Ta=25°C)

| Parameter  | Symbol    | Rating     | Unit |
|--|-----------|------------|------|
| Continuous Forward Current                                   | $I_F$     | 100        | mA   |
| Peak Forward Current(*1)                                     | $I_{FP}$  | 1.0        | A    |
| Reverse Voltage  | $V_R$     | 5          | V    |
| Operating Temperature  | $T_{opr}$ | -40 ~ +85  | °C   |
| Storage Temperature  | $T_{stg}$ | -40 ~ +100 | °C   |
| Soldering Temperature(*2)                                    | $T_{sol}$ | 260        | °C   |
| Power Dissipation at (or below)<br>25°C Free Air Temperature | $P_d$     | 150        | mW   |

**Notes:** \*1: $I_{FP}$  Conditions--Pulse Width  $\leq 100\mu s$  and Duty  $\leq 1\%$ .  
\*2:Soldering time  $\leq 5$  seconds.

**Electro-Optical Characteristics (Ta=25°C)**

| Parameter          | Symbol          | Min.  | Typ. | Max.  | Unit  | Condition  |
|--------------------|-----------------|-------|------|-------|-------|--|
| Radiant Intensity  | $I_e$           | 7.8   | 20   | ---   | mW/sr | $I_F=20mA$   |
|                    |                 | ----- | 90   | ----- |       | $I_F=100mA$<br>Pulse Width $\leq 100\mu s$ , Duty $\leq 1\%$ |
| Peak Wavelength    | $\lambda_p$     | ----- | 875  | ----- | nm    | $I_F=20mA$   |
| Spectral Bandwidth | $\Delta\lambda$ | ----- | 80   | ----- | nm    | $I_F=20mA$   |
| Forward Voltage    | VF              | ----- | 1.3  | 1.65  | V     | $I_F=20mA$   |
|                    |                 | ----- | 1.4  | 1.8   |       | $I_F=100mA$<br>Pulse Width $\leq 100\mu s$ , Duty $\leq 1\%$ |
| Reverse Current    | $I_R$           | ----- | ---- | 10    | uA    | $V_R=5V$   |
| View Angle         | $2\theta_{1/2}$ | ----- | 20   | ----- | deg   | $I_F=20mA$   |

**Rank**

Condition:  $I_F=20mA$

Unit: mW/sr

| Bin number | M    | N    | P  | Q  | R  |
|------------|------|------|----|----|----|
| Min        | 7.8  | 11   | 15 | 21 | 30 |
| Max        | 12.5 | 17.6 | 24 | 34 | 48 |

Note:

\*Measurement Uncertainty of Forward Voltage:  $\pm 0.1V$

\*Measurement Uncertainty of Luminous Intensity:  $\pm 10\%$

\*Measurement Uncertainty of Dominant Wavelength  $\pm 1.0nm$

Typical Electro-Optical Characteristics Curves

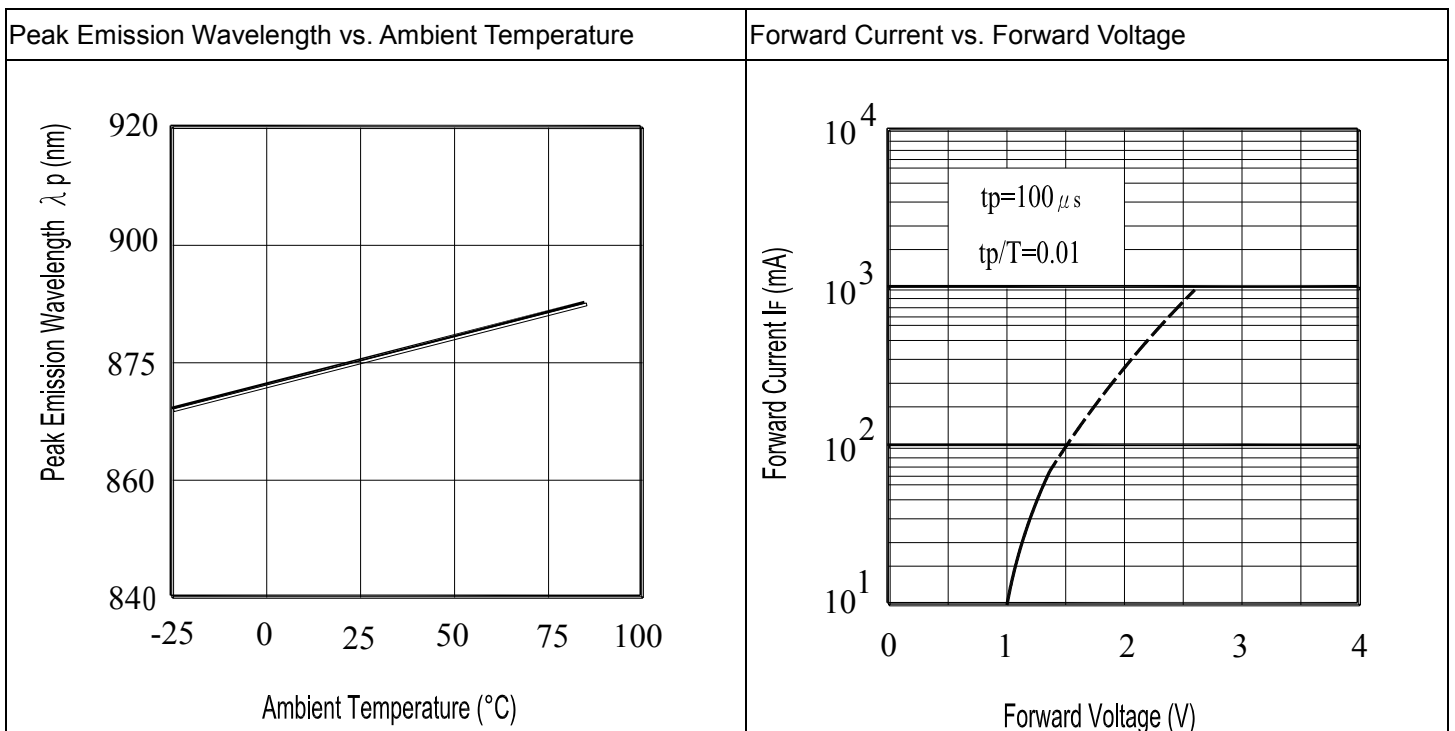
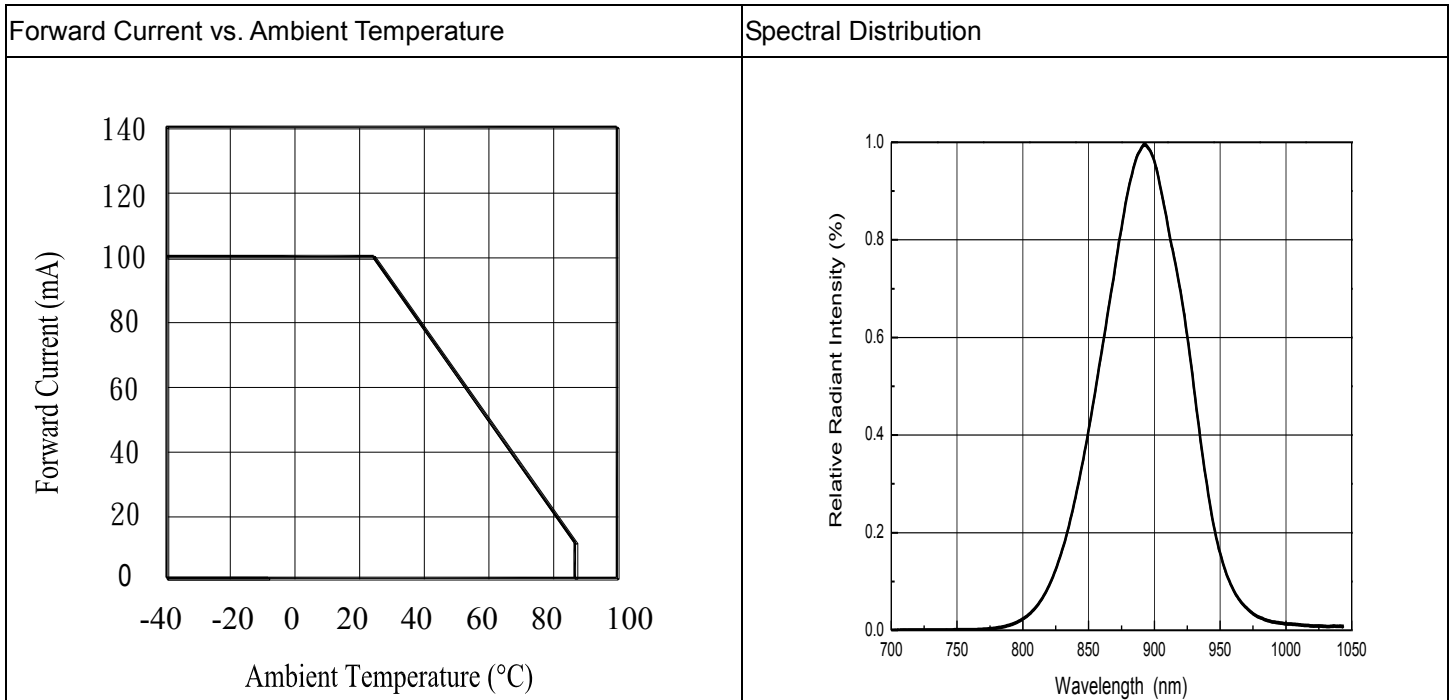

Radiant Intensity vs. Forward Current

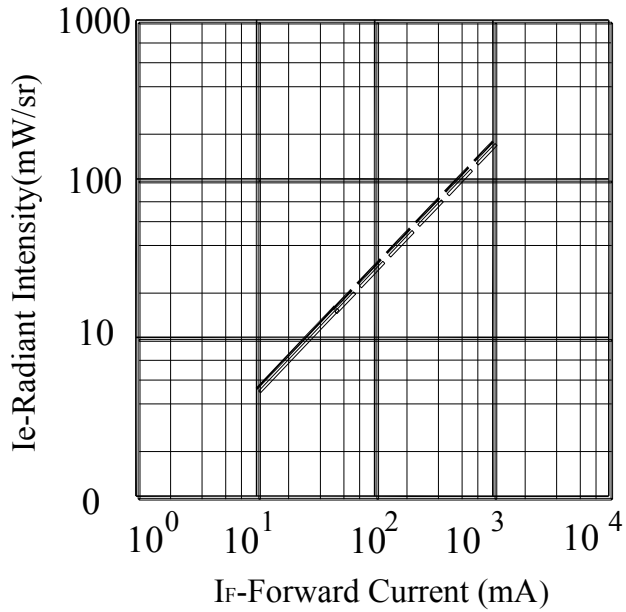

Relative Radiant Intensity vs. Angular Displacement

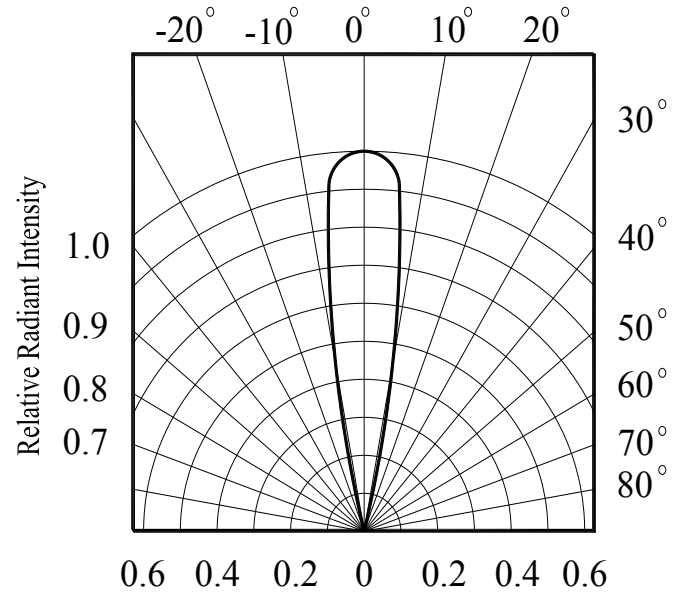

## Package Dimension

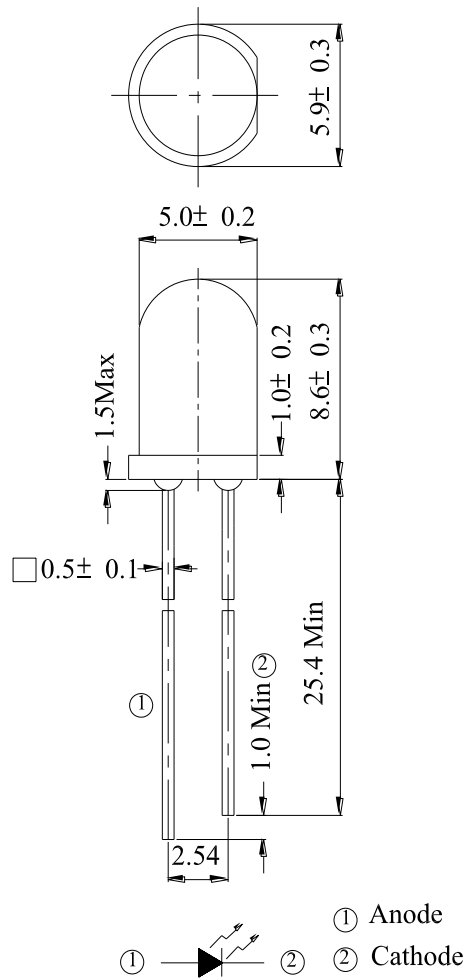

Note: Tolerances unless dimensions  $\pm 0.25$ mm

### Label Form Specification

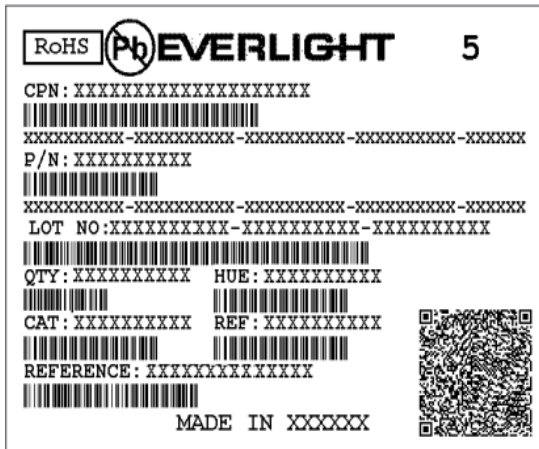

- CPN: Customer's Product Number
- P/N: Product Number
- QTY: Packing Quantity
- CAT: Luminous Intensity Rank
- HUE: Dom. Wavelength Rank
- REF: Forward Voltage Rank
- LOT No: Lot Number
- X: Month
- Reference: Identify Label Number

- Packing Quantity  
.200~ 500 PCS/1 Bag, 5 Bags/1 Inner Carton  
.10 Inner Cartons/1 Outside Carton

### Notes

1. Lead Forming
  - During lead formation, the leads should be bent at a point at least 3mm from the base of the epoxy bulb.
  - Lead forming should be done before soldering.
  - Avoid stressing the LED package during leads forming. The stress to the base may damage the LED's characteristics or it may break the LEDs.
  - Cut the LED lead frames at room temperature. Cutting the lead frames at high temperatures may cause failure of the LEDs.
  - When mounting the LEDs onto a PCB, the PCB holes must be aligned exactly with the lead position of the LED. If the LEDs are mounted with stress at the leads, it causes deterioration of the epoxy resin and this will degrade the LEDs.
2. Storage
  - The LEDs should be stored at 30°C or less and 70%RH or less after being shipped from Everlight and the storage life limits are 3 months. If the LEDs are stored for 3 months or more, they can be stored for a year in a sealed container with a nitrogen atmosphere and moisture absorbent material.
  - Please avoid rapid transitions in ambient temperature, especially, in high humidity environments where condensation can occur.

3. Soldering

- Careful attention should be paid during soldering. When soldering, leave more than 3mm from solder joint to epoxy bulb, and soldering beyond the base of the tie bar is recommended.
- Recommended soldering conditions:

| Hand Soldering       |   | DIP Soldering     |  |
|----------------------|---|-------------------|--|
| Temp. at tip of iron | 300°C Max. (30W Max.)                     | Preheat temp.     | 100°C Max. (60 sec Max.)                   |
| Soldering time       | 3 sec Max.                                | Bath temp. & time | 260 Max., 5 sec Max                        |
| Distance             | 3mm Min.(From solder joint to epoxy bulb) | Distance          | 3mm Min. (From solder joint to epoxy bulb) |

- Recommended soldering profile

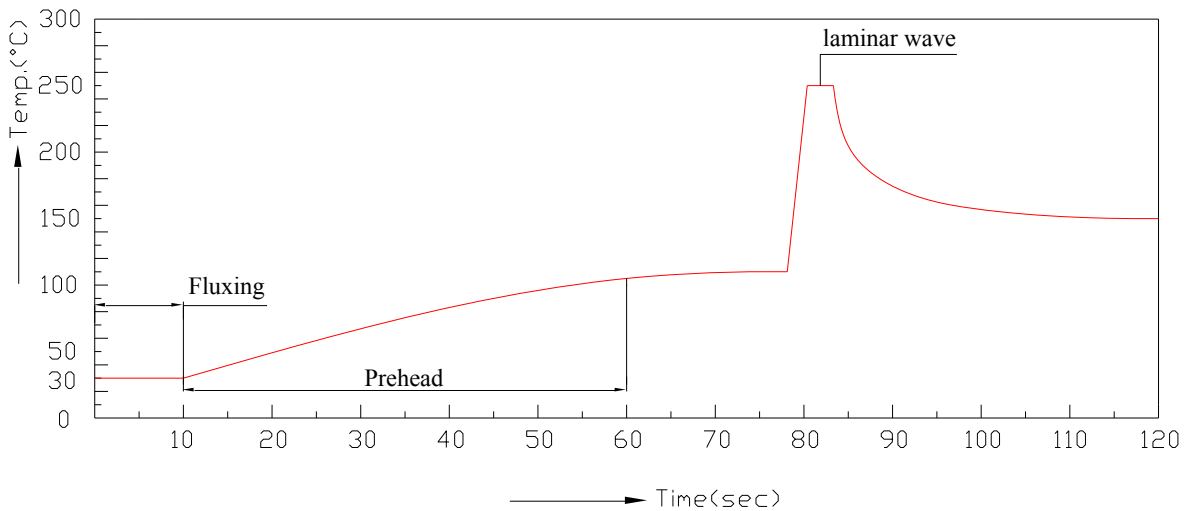

- Avoiding applying any stress to the lead frame while the LEDs are at high temperature particularly when soldering.
- Dip and hand soldering should not be done more than one time
- After soldering the LEDs, the epoxy bulb should be protected from mechanical shock or vibration until the LEDs return to room temperature.
- A rapid-rate process is not recommended for cooling the LEDs down from the peak temperature. Although the recommended soldering conditions are specified in the above table, dip or hand soldering at the lowest possible temperature is desirable for the LEDs.
- Wave soldering parameter must be set and maintain according to recommended temperature and dwell time in the solder wave.

4. Cleaning

- When necessary, cleaning should occur only with isopropyl alcohol at room temperature for a duration of no more than one minute. Dry at room temperature before use.
- Do not clean the LEDs by the ultrasonic. When it is absolutely necessary, the influence of ultrasonic cleaning on the LEDs depends on factors such as ultrasonic power and the assembled condition. Ultrasonic cleaning shall be pre-qualified to ensure this will not cause damage to the LED

5. Heat Management

- Heat management of LEDs must be taken into consideration during the design stage of LED application. The current should be de-rated appropriately by referring to the de-rating curve found in each product specification.
- The temperature surrounding the LED in the application should be controlled. Please refer to the data sheet de-rating curve.



6. ESD (Electrostatic Discharge)
  - Electrostatic discharge (ESD) or surge current (EOS) can damage LEDs.
  - An ESD wrist strap, ESD shoe strap or antistatic gloves must be worn whenever handling LEDs.
  - All devices, equipment and machinery must be properly grounded.
  - Use ion blower to neutralize the static charge which might have built up on surface of the LEDs plastic lens as a result of friction between LEDs during storage and handing.

## DISCLAIMER

1. EVERLIGHT reserves the right(s) on the adjustment of product material mix for the specification.
2. The product meets EVERLIGHT published specification for a period of twelve (12) months from date of shipment.
3. The graphs shown in this datasheet are representing typical data only and do not show guaranteed values.
4. When using this product, please observe the absolute maximum ratings and the instructions for using outlined in these specification sheets. EVERLIGHT assumes no responsibility for any damage resulting from the use of the product which does not comply with the absolute maximum ratings and the instructions included in these specification sheets.
5. These specification sheets include materials protected under copyright of EVERLIGHT. Reproduction in any form is prohibited without obtaining EVERLIGHT's prior consent.
6. This product is not intended to be used for military, aircraft, automotive, medical, life sustaining or life saving applications or any other application which can result in human injury or death. Please contact authorized Everlight sales agent for special application request.