

Sidelooker Phototransistor PT928-6B-F

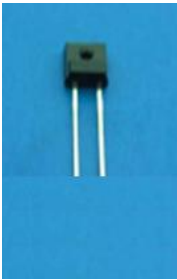

Features

- Fast response time
- High sensitivity
- Small junction capacitance
- Pb Free
- This product itself will remain within RoHS compliant version
- Compliance with EU REACH
- Compliance Halogen Free (Br < 900ppm, Cl < 900ppm, Br+Cl < 1500ppm)

Descriptions

- PT928-6B-F is a phototransistor in miniature package which is molded in a plastic with spherical top view lens
- The device is spectrally matched to infrared emitting diode

Applications

- Optoelectronic switch
- VCR, Video Camera
- Floppy disk drive
- Infrared applied system

Device Selection Guide

Part Category	Chip Material	Lens Color
PT	Silicon	Black

Package Dimension

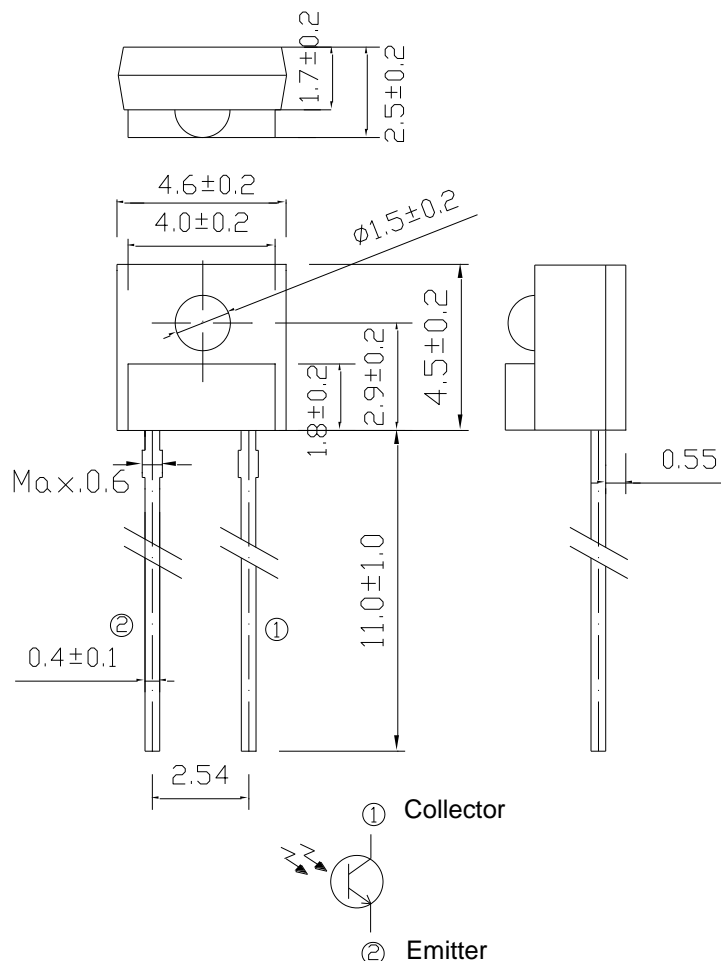

Notes: 1. All dimensions are in millimeters
 2. Tolerances unless dimensions $\pm 0.3\text{mm}$

Absolute Maximum Ratings ($T_a=25^\circ\text{C}$)

Parameter	Symbol	Rating	Units
Collector-Emitter Voltage	V_{CE0}	30	V
Emitter-Collector Voltage	V_{ECO}	5	V
Collector Current	I_C	20	mA
Operating Temperature	T_{opr}	-25 ~ +85	$^\circ\text{C}$
Storage Temperature	T_{stg}	-40 ~ +85	$^\circ\text{C}$
Soldering Temperature *1	T_{sol}	260	$^\circ\text{C}$
Power Dissipation at (or below) 25 $^\circ\text{C}$ Free Air Temperature	P_d	75	mW

Notes: *1. Soldering time ≤ 5 seconds.

Electro-Optical Characteristics (Ta=25°C)

Parameter	Symbol	Condition	Min.	Typ.	Max.	Units
Rang of Spectral Bandwidth	$\lambda_{0.5}$	----	740	--	1100	nm
Wavelength of Peak Sensitivity	λ_p	----	--	940	--	nm
Collector-Emitter Breakdown Voltage	BV_{CEO}	$I_C=100\mu A$ $E_e=0mW/cm^2$	30	--	--	V
Emitter-Collector Breakdown Voltage	BV_{ECO}	$I_E=100\mu A$ $E_e=0mW/cm^2$	5	--	--	V
Collector Dark Current	I_{CEO}	$V_{CE}=20V$ $E_e=0mW/cm^2$	--	--	100	nA
Collector-Emitter Saturation Voltage	$V_{CE(sat)}$	$I_C=2mA$ $E_e=1mW/cm^2$	--	--	0.4	V
On State Collector Current	$I_{C(on)}$	$V_{CE}=5V$ $E_e=0.555mW/cm^2$	0.53	--	3.41	mA

Rank

Condition: $V_{CE}=5V$, $E_e=0.555mW/cm^2$

Symbol	Condition	Ranks	Min.	Max.	Unit
$I_{C(ON)}$	$V_{CE}=5V$ $E_e=0.555mW/cm^2$	7-3	0.53	1.19	mA
		7-2	0.88	1.70	
		7-1	1.24	2.21	
		6-2	1.59	2.98	
		6-1	1.77	3.41	

Notes: This bin table is only for reference, not for specific bin shipment.

Test Method For $I_{C(ON)}$:

Condition: $V_{CE}=5V$ $E_e=0.555mW/cm^2$

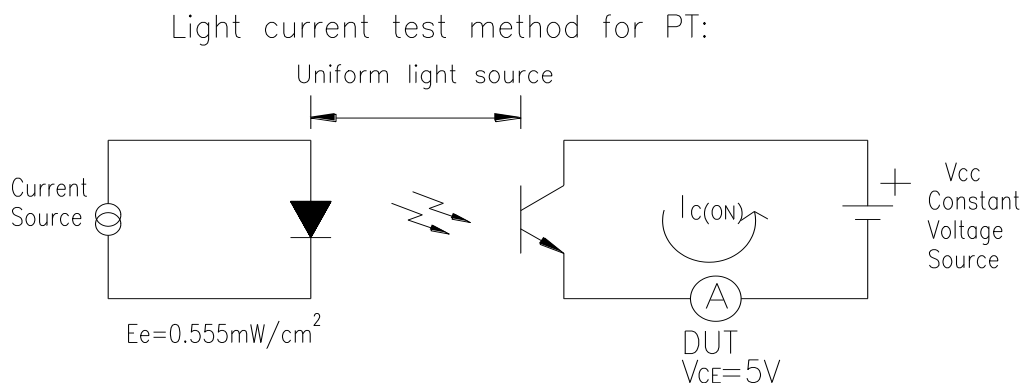

Typical Electro-Optical Characteristics Curves

Fig.1 Spectral Sensitivity

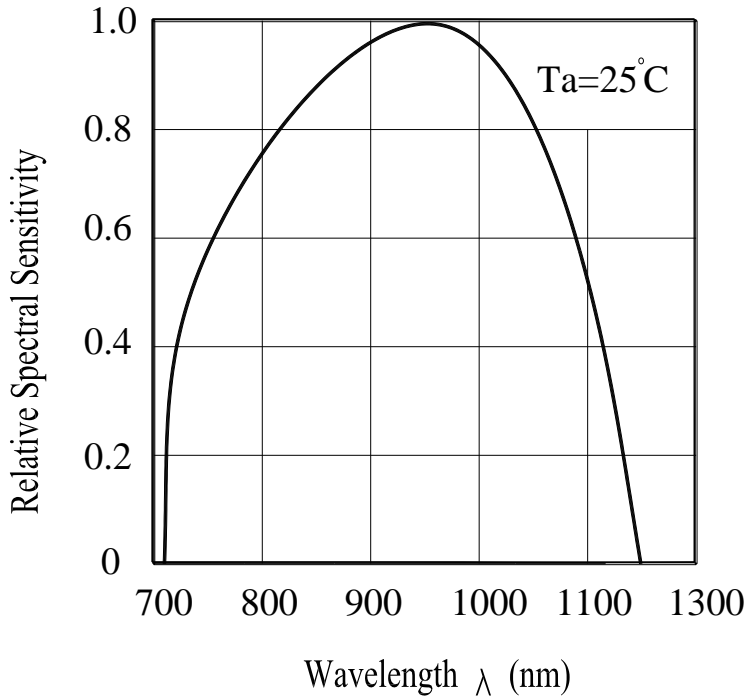

Fig.2 Collector Current vs Irradiance

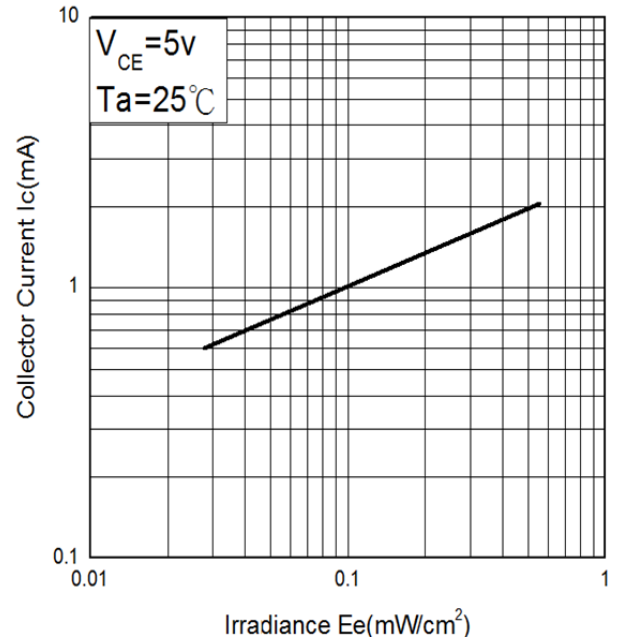
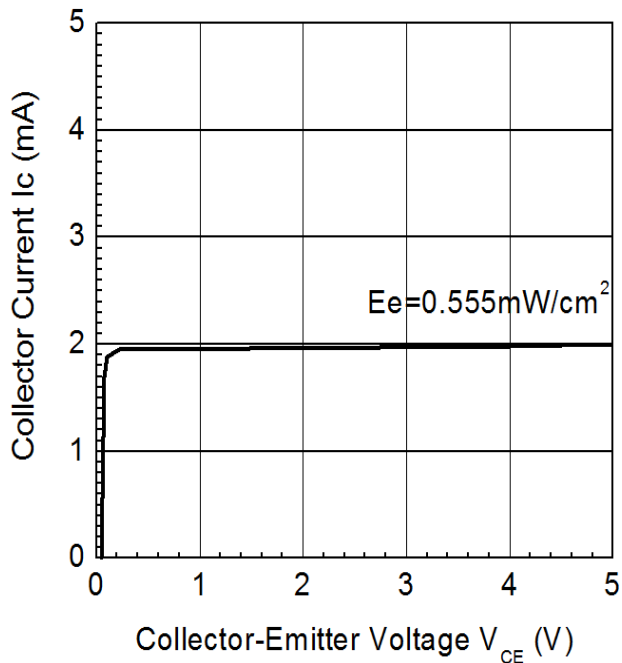

Fig.3 Collector Current vs. Collector-Emitter Voltage



Packing Quantity Specification

1000 pcs/bag, 10 bags/box
10 boxes/carton

Label Form Specification

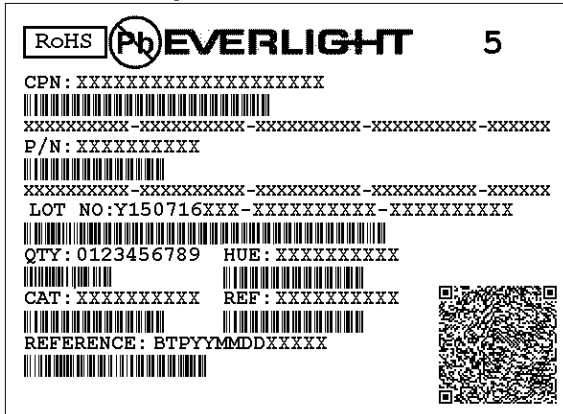

- CPN: Customer Part Number
- P/N: Part Number
- QTY: Packing Quantity
- CAT: Ranks
- REF: Reference
- LOT No: Lot Number

Notes

Lead Forming

1. During lead frame bending, the lead frame should be bent at a distance more than 3mm from bottom of the epoxy.
Note: Must fix lead frame and do not touch epoxy before bending to avoid Phototransistors broken.
2. Lead forming should be done before soldering.
3. Avoid stressing the Phototransistor package during leads forming. The stress to the base may damage the Phototransistor's characteristics or it may break the Phototransistors.
4. Cut the Phototransistor lead frame at room temperature. Cutting the lead frame at high temperatures may cause failure of the Phototransistors.
5. When mounting the Phototransistors onto a PCB, the PCB holes must be aligned exactly with the lead position of the Phototransistor. If the Phototransistors are mounted with stress at the leads, it causes deterioration of the epoxy resin and this will degrade the Phototransistors.

Storage

1. The Phototransistors should be stored at 10~30°C and 70%RH or less after being shipped from Everlight and the storage life limits are 3 months. If the Phototransistors are stored for 3 months or more, they can be stored at 10°C~25°C and 20%RH~60%RH for a year in a sealed container with a nitrogen atmosphere. After opening the package, the devices must be stored at 10°C~25°C and 20%RH~60%RH, and suggested to be used within 24 hours or as soon as possible. Besides, suggest that the remaining devices seal in the package bag as soon as possible please.
2. Please avoid rapid transitions in ambient temperature, especially in high humidity environments where condensation can occur.

Soldering

- Careful attention should be paid during soldering. When soldering, leave more than 3mm from solder joint to epoxy bulb, and soldering beyond the base of the tie bar is recommended.
- Recommended soldering conditions:

Hand Soldering		DIP Soldering	
Temp. at tip of iron	300°C Max. (30W Max.)	Preheat temp.	100°C Max. (60 sec Max.)
Soldering time	3 sec Max.	Bath temp. & time	260 Max., 5 sec Max
Distance	3mm Min.(From solder joint to epoxy bulb)	Distance	3mm Min. (From solder joint to epoxy bulb)

- Recommended soldering profile

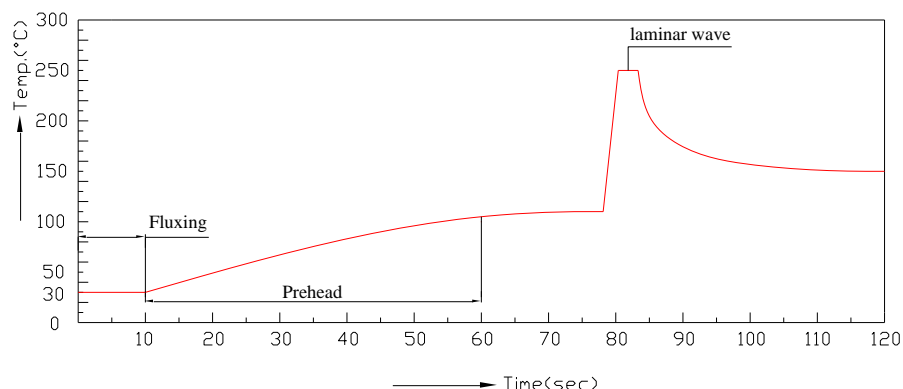

- Avoiding applying any stress to the lead frame while the Phototransistors are at high temperature particularly when soldering.
- Dip and hand soldering should not be done more than one time
- After soldering the Phototransistors, the epoxy bulb should be protected from mechanical shock or vibration until the Phototransistors return to room temperature.
- A rapid-rate process is not recommended for cooling the Phototransistors down from the peak temperature.
- Although the recommended soldering conditions are specified in the above table, dip or hand soldering at the lowest possible temperature is desirable for the Phototransistors.
- Wave soldering parameter must be set and maintain according to recommended temperature and dwell time in the solder wave.

Cleaning

Do not clean the Phototransistors by the ultrasonic.

Heat Management

- Heat management of Phototransistors must be taken into consideration during the design stage of Phototransistor application. The current should be de-rated appropriately by referring to the de-rating curve found in each product specification.
- The temperature surrounding the Phototransistor in the application should be controlled.

ESD (Electrostatic Discharge)

1. The products are sensitive to static electricity or surge voltage. ESD can damage a die and its reliability.
2. When handling the products, the following measures against electrostatic discharge are strongly recommended:
 - Eliminating the charge
 - Grounded wrist strap, ESD footwear, clothes and floors
 - Grounded workstation equipment and tools
 - ESD table/shelf mat made of conductive materials
3. Proper grounding is required for all devices, equipment, and machinery used in product assembly. Surge protection should be considered when designing of commercial products.
4. If tools or equipment contain insulating materials such as glass or plastic, the following measures against electrostatic discharge are strongly recommended:
 - Dissipating static charge with conductive materials
 - Preventing charge generation with moisture
 - Neutralizing the charge with ionizers

DISCLAIMER

1. EVERLIGHT reserves the right(s) on the adjustment of product material mix for the specification.
2. The product meets EVERLIGHT published specification for a period of twelve (12) months from date of shipment.
3. The graphs shown in this datasheet are representing typical data only and do not show guaranteed values.
4. When using this product, please observe the absolute maximum ratings and the instructions for using outlined in these specification sheets. EVERLIGHT assumes no responsibility for any damage resulting from the use of the product which does not comply with the absolute maximum ratings and the instructions included in these specification sheets.
5. These specification sheets include materials protected under copyright of EVERLIGHT. Reproduction in any form is prohibited without obtaining EVERLIGHT's prior consent.
6. This product is not intended to be used for military, aircraft, automotive, medical, life sustaining or life saving applications or any other application which can result in human injury or death. Please contact authorized Everlight sales agent for special application request.