



Solid State Relay  
OCMOS FET

# PS7141C-2A, PS7141CL-2A

8-PIN DIP, 200 mA TYP.  
CURRENT LIMIT TYPE  
2-ch Optical Coupled MOS FET

–NEPOC Series–

## DESCRIPTION

The PS7141C-2A and PS7141CL-2A are solid state relays containing GaAs LEDs on the light emitting side (input side) and MOS FETs including current control circuit on the output side. Current control circuit of OCMOS FET protects this device from thermal breakdown and output circuit.

They are suitable for analog signal control because of their low offset and high linearity.

The PS7141CL-2A has a surface mount type lead.

## FEATURES

- Limit current ( $I_{LMT} = 170$  to  $250$  mA)
- 2 channel type (1 a + 1 a output)
- Low LED operating current ( $I_F = 2$  mA)
- Designed for AC/DC switching line changer
- Small package (8-pin DIP)
- Low offset voltage
- Ordering number of taping product : PS7141CL-2A-E3, E4: 1 000 pcs/reel
- Pb-Free product
- Safety standards
  - UL approved: File No. E72422
  - BSI approved: No. 8245/8246
  - CSA approved: No. CA 101391

<R>

<R>

## APPLICATIONS

- Exchange equipment
- Measurement equipment
- FA/OA equipment

The information in this document is subject to change without notice. Before using this document, please confirm that this is the latest version.

**PACKAGE DIMENSIONS (in millimeters)**

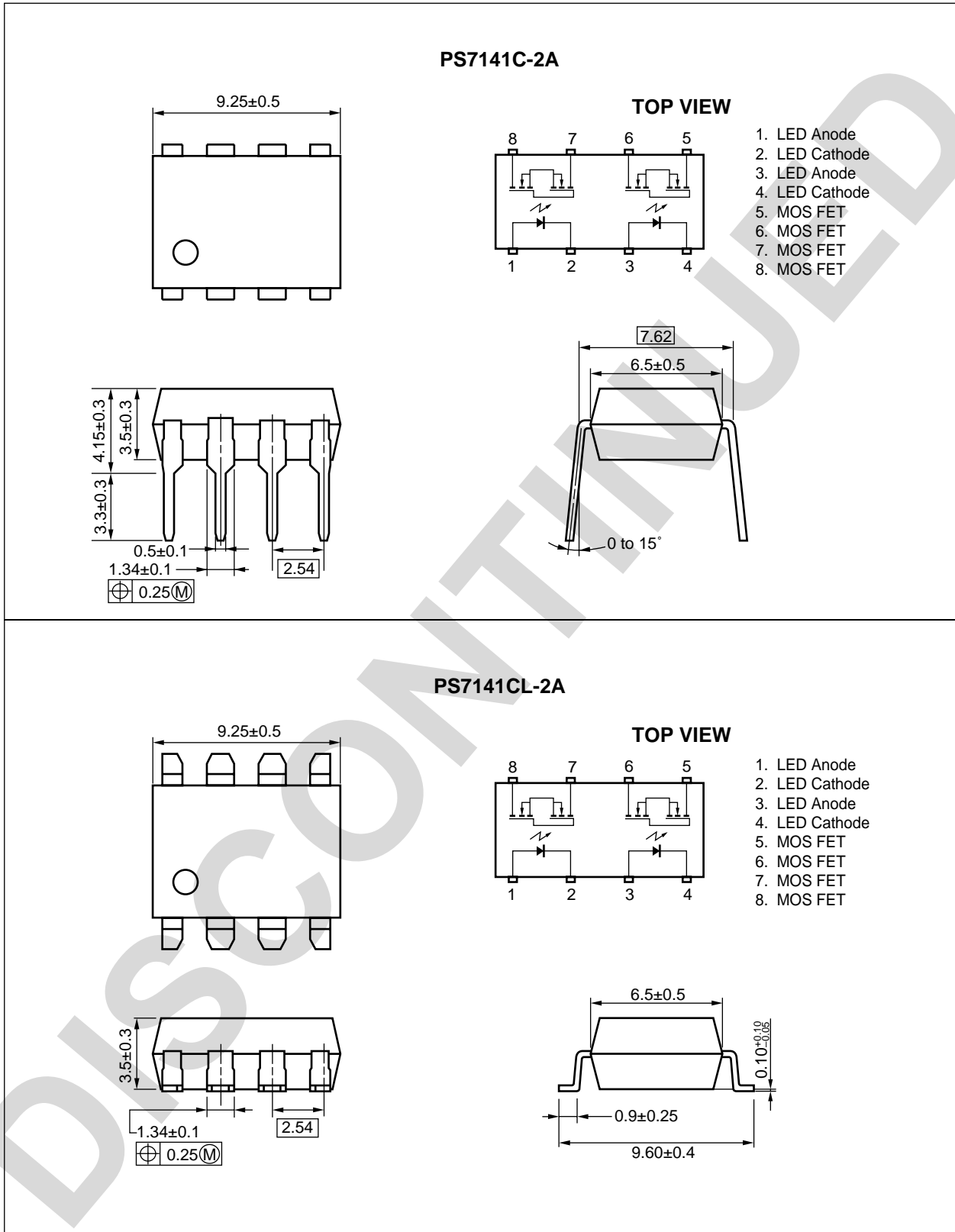

<R> MARKING EXAMPLE

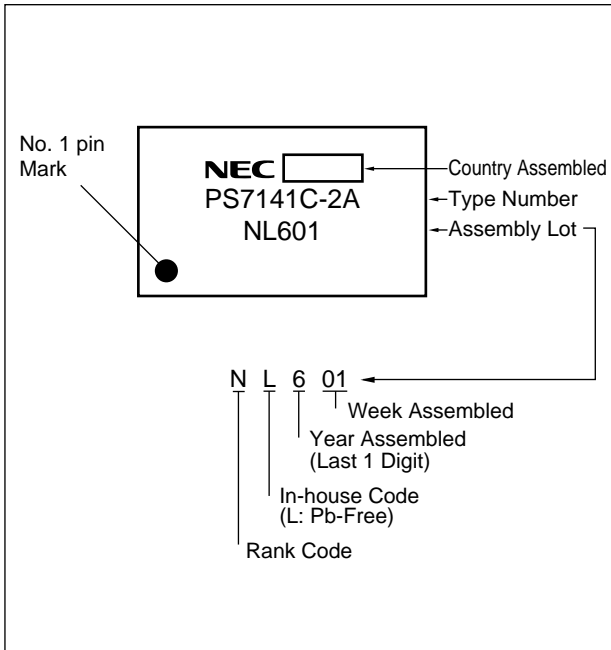

DISCONTINUED

<R> **ORDERING INFORMATION**

Part Number	Order Number	Solder Plating Specification	Packing Style	Safety Standard Approval	Application Part Number <sup>*1</sup>
PS7141C-2A	PS7141C-2A-A	Pb-Free	Magazine case 50 pcs	Standard products (UL, BSI, CSA approved)	PS7141C-2A
PS7141CL-2A	PS7141CL-2A-A		Embossed Tape 1 000 pcs/reel		
PS7141CL-2A-E3	PS7141CL-2A-E3-A				
PS7141CL-2A-E4	PS7141CL-2A-E4-A				

\*1 For the application of the Safety Standard, following part number should be used.

**ABSOLUTE MAXIMUM RATINGS (T<sub>A</sub> = 25°C, unless otherwise specified)**

Parameter		Symbol	Ratings	Unit
Diode	Forward Current (DC)	I <sub>F</sub>	50	mA/ch
	Reverse Voltage	V <sub>R</sub>	5.0	V
	Power Dissipation	P <sub>D</sub>	50	mW/ch
	Peak Forward Current <sup>*1</sup>	I <sub>FP</sub>	1	A/ch
MOS FET	Break Down Voltage	V <sub>L</sub>	400	V
	Continuous Load Current	I <sub>L</sub>	120	mA/ch
	Pulse Load Current <sup>*2</sup> (AC/DC Connection)	I <sub>LP</sub>	120	mA/ch
	Power Dissipation	P <sub>D</sub>	375	mW/ch
Isolation Voltage <sup>*3</sup>		BV	1 500	Vr.m.s.
Total Power Dissipation		P <sub>T</sub>	850	mW
Operating Ambient Temperature		T <sub>A</sub>	-40 to +85	°C
Storage Temperature		T <sub>stg</sub>	-40 to +100	°C

\*1 PW = 100 μs, Duty Cycle = 1%

\*2 PW = 100 ms, 1 shot

\*3 AC voltage for 1 minute at T<sub>A</sub> = 25°C, RH = 60% between input and output.  
Pins 1-4 shorted together, 5-8 shorted together.

**RECOMMENDED OPERATING CONDITIONS (T<sub>A</sub> = 25°C)**

Parameter	Symbol	MIN.	TYP.	MAX.	Unit
LED Operating Current	I <sub>F</sub>	2	10	20	mA
LED Off Voltage	V <sub>F</sub>	0		0.5	V

**ELECTRICAL CHARACTERISTICS (T<sub>A</sub> = 25°C)**

Parameter		Symbol	Conditions	MIN.	TYP.	MAX.	Unit
Diode	Forward Voltage	V <sub>F</sub>	I <sub>F</sub> = 10 mA		1.2	1.4	V
	Reverse Current	I <sub>R</sub>	V <sub>R</sub> = 5 V			5.0	μA
MOS FET	Off-state Leakage Current	I <sub>Loff</sub>	V <sub>D</sub> = 400 V		0.03	1.0	μA
	Output Capacitance	C <sub>out</sub>	V <sub>D</sub> = 0 V, f = 1 MHz		65		pF/ch
Coupled	LED On-state Current	I <sub>Fon</sub>	I <sub>L</sub> = 120 mA			2.0	mA
	On-state Resistance	R <sub>on1</sub>	I <sub>F</sub> = 10 mA, I <sub>L</sub> = 10 mA		26	35	Ω
		R <sub>on2</sub>	I <sub>F</sub> = 10 mA, I <sub>L</sub> = 120 mA, t ≤ 10 ms		22	30	
	Turn-on Time *1,2	t <sub>on</sub>	I <sub>F</sub> = 10 mA, V <sub>O</sub> = 5 V, R <sub>L</sub> = 500 Ω,		0.6	2.0	ms
	Turn-off Time *1,2	t <sub>off</sub>	PW ≥ 10 ms		0.03	1.0	
	Isolation Resistance	R <sub>I-O</sub>	V <sub>I-O</sub> = 1.0 kV <sub>DC</sub>	10 <sup>9</sup>			Ω
	Isolation Capacitance	C <sub>I-O</sub>	V = 0 V, f = 1 MHz		1.1		pF/ch
Limit Current	I <sub>LMT</sub>	I <sub>F</sub> = 10 mA, t = 5 ms, V <sub>L</sub> = 6 V	170	200	250	mA/ch	

\*1 Test Circuit for Switching Time

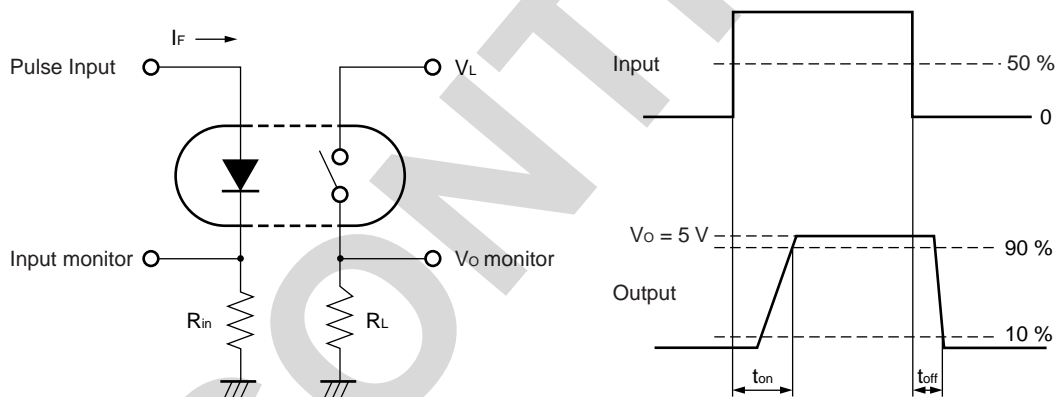

<R> \*2 The turn-on time and turn-off time are specified as input-pulse width ≥ 10 ms. Be aware that when the device operates with an input-pulse width less than 10 ms, the turn-on time and turn-off time will increase.

**TYPICAL CHARACTERISTICS ( $T_A = 25^\circ\text{C}$ , unless otherwise specified)**

MAXIMUM FORWARD CURRENT vs. AMBIENT TEMPERATURE

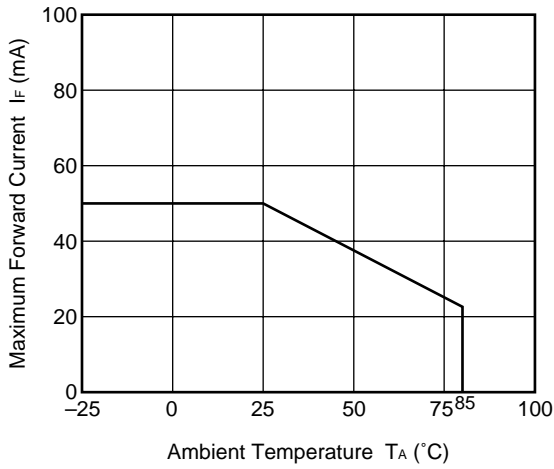

MAXIMUM LOAD CURRENT vs. AMBIENT TEMPERATURE

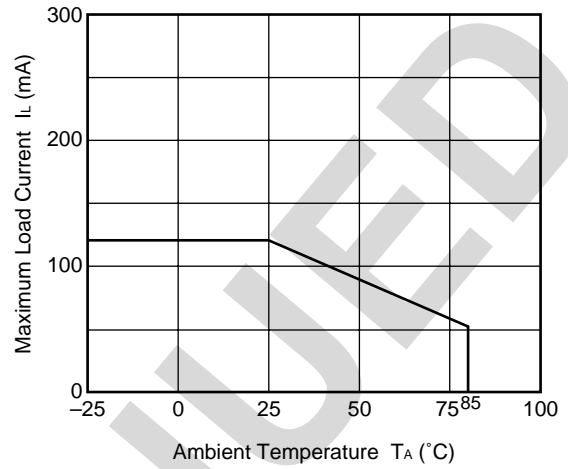

FORWARD VOLTAGE vs. AMBIENT TEMPERATURE

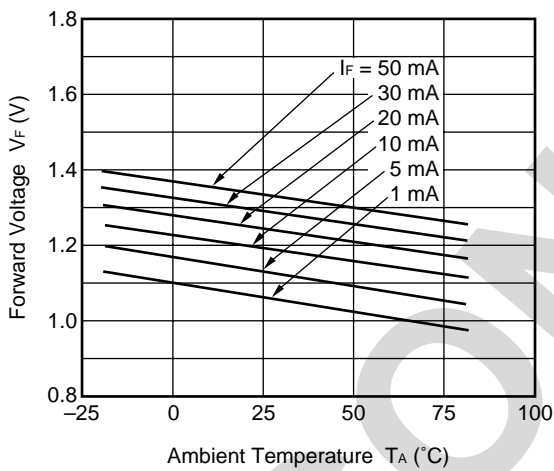

OUTPUT CAPACITANCE vs. APPLIED VOLTAGE

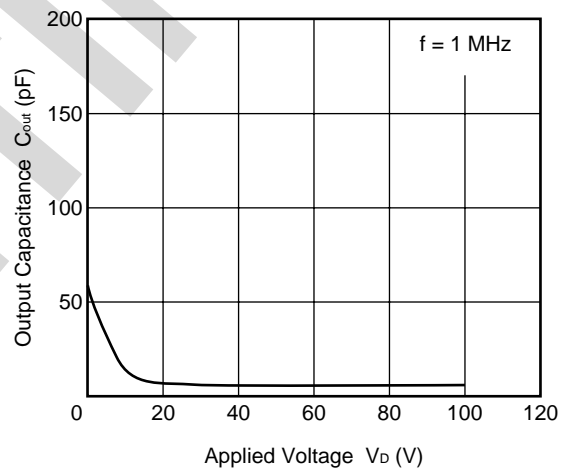

OFF-STATE LEAKAGE CURRENT vs. APPLIED VOLTAGE

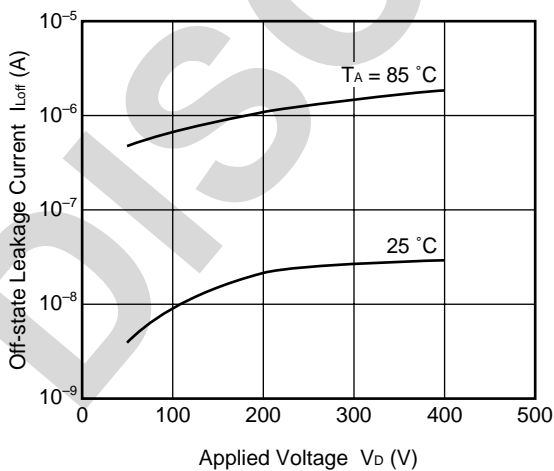

LOAD CURRENT vs. LOAD VOLTAGE

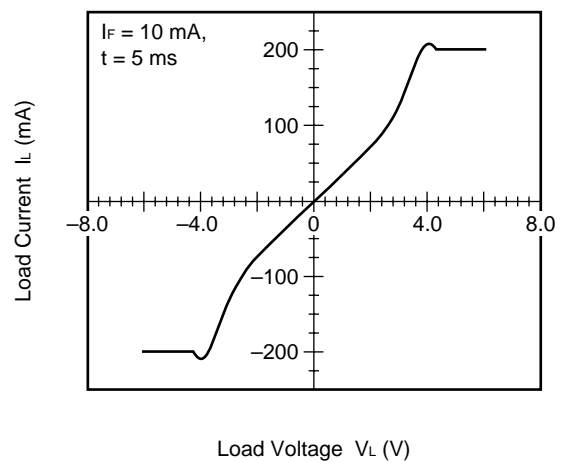

**Remark** The graphs indicate nominal characteristics.

NORMALIZED ON-STATE RESISTANCE vs. AMBIENT TEMPERATURE

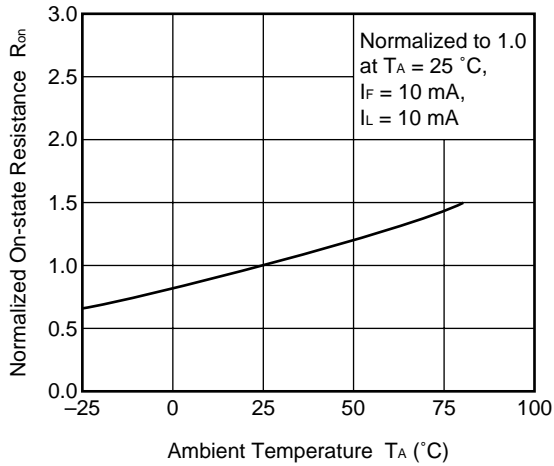

ON-STATE RESISTANCE DISTRIBUTION

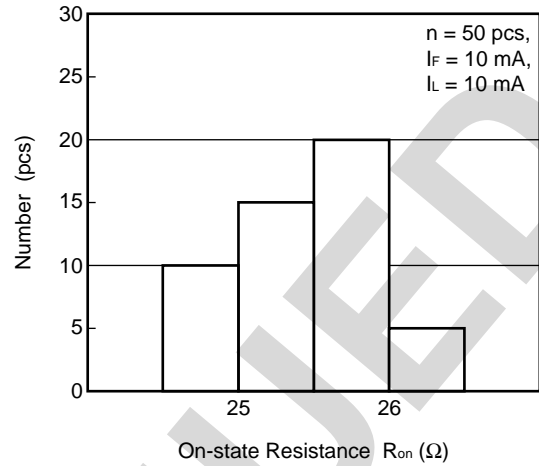

TURN-ON TIME vs. FORWARD CURRENT

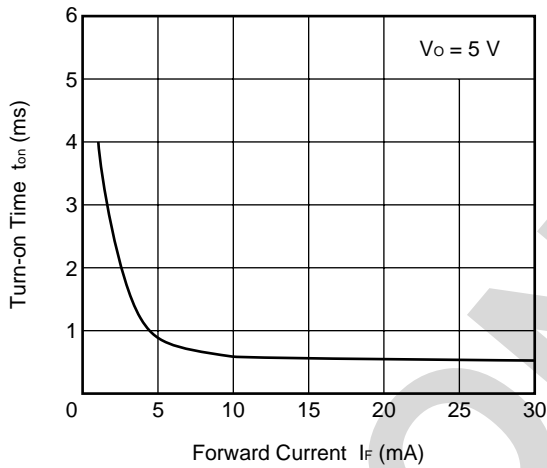

TURN-OFF TIME vs. FORWARD CURRENT

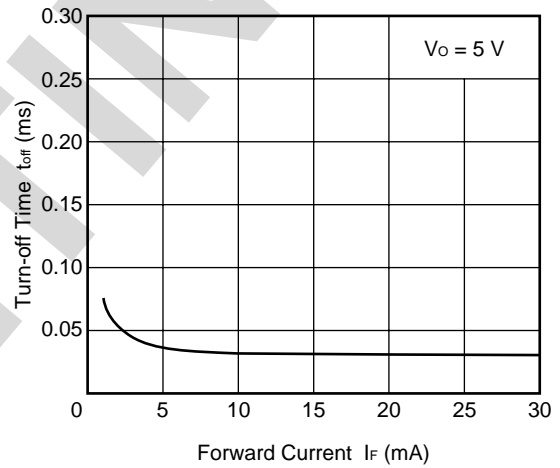

TURN-ON TIME DISTRIBUTION

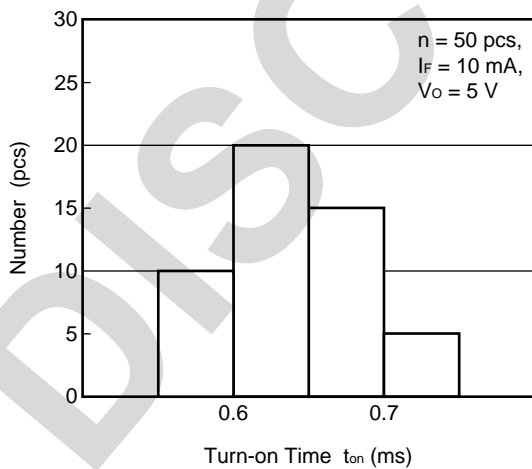

TURN-OFF TIME DISTRIBUTION

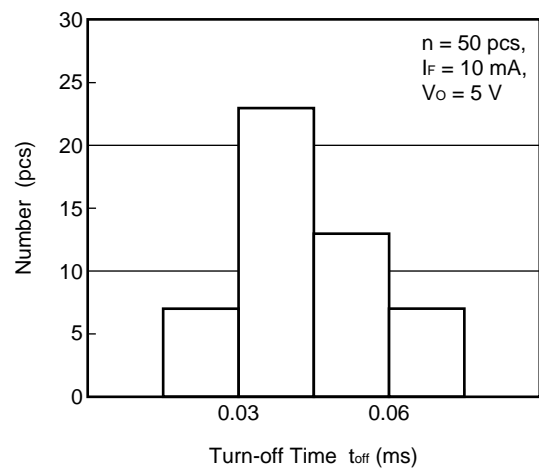

**Remark** The graphs indicate nominal characteristics.

NORMALIZED TURN-ON TIME vs. AMBIENT TEMPERATURE

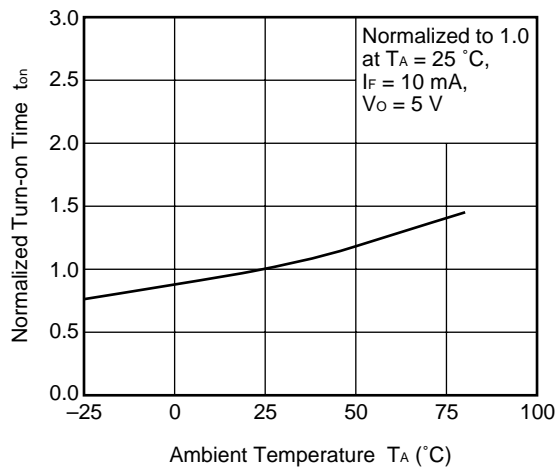

NORMALIZED TURN-OFF TIME vs. AMBIENT TEMPERATURE

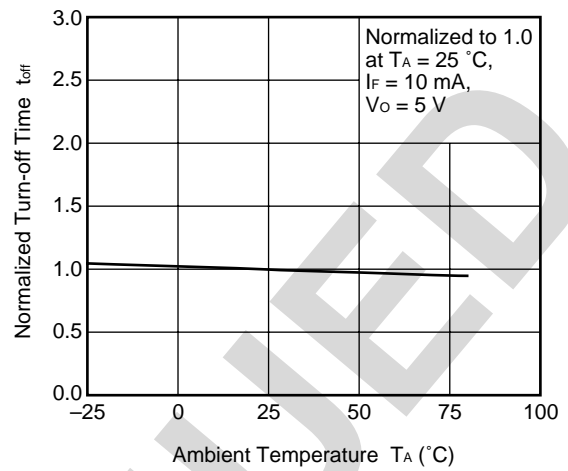

NORMALIZED LIMIT CURRENT vs. AMBIENT TEMPERATURE

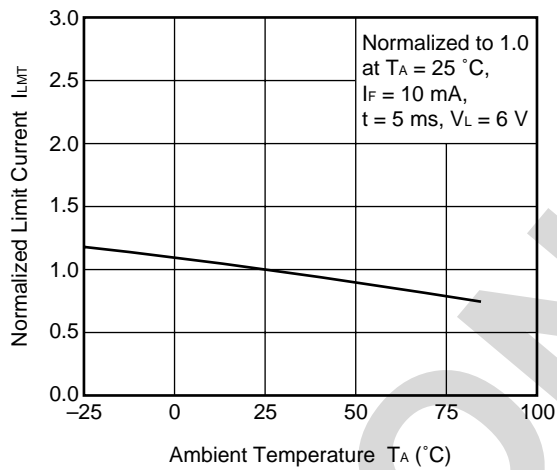

**Remark** The graphs indicate nominal characteristics.



TAPING SPECIFICATIONS (in millimeters)

Outline and Dimensions (Tape)

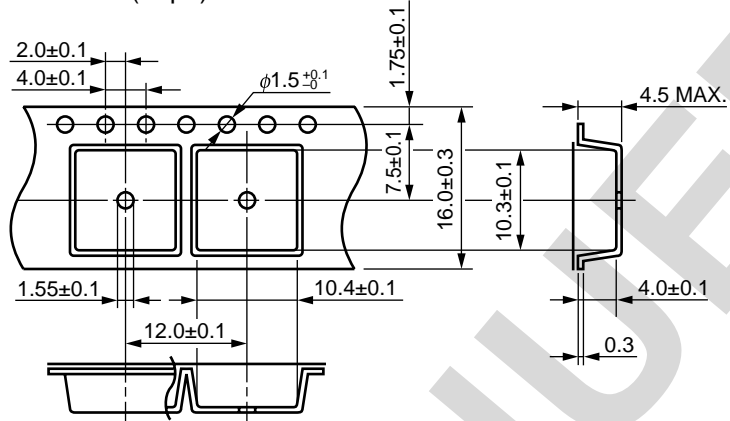

Tape Direction

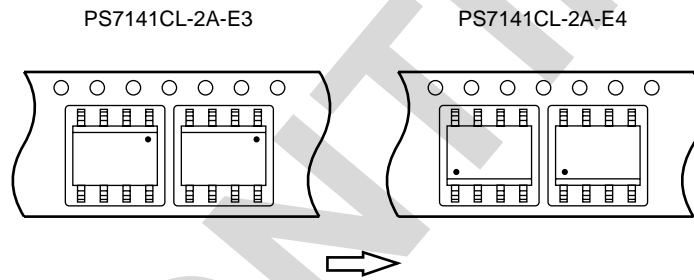

Outline and Dimensions (Reel)

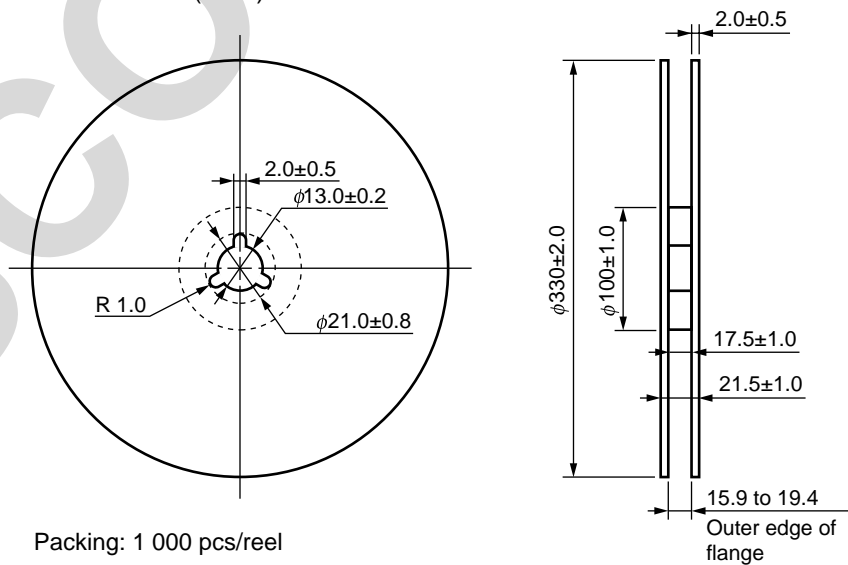

Packing: 1 000 pcs/reel

**RECOMMENDED SOLDERING CONDITIONS**

**(1) Infrared reflow soldering**

- Peak reflow temperature 260°C or below (package surface temperature)
- Time of peak reflow temperature 10 seconds or less
- Time of temperature higher than 220°C 60 seconds or less
- Time to preheat temperature from 120 to 180°C 120±30 s
- Number of reflows Three
- Flux Rosin flux containing small amount of chlorine (The flux with a maximum chlorine content of 0.2 Wt% is recommended.)

Recommended Temperature Profile of Infrared Reflow

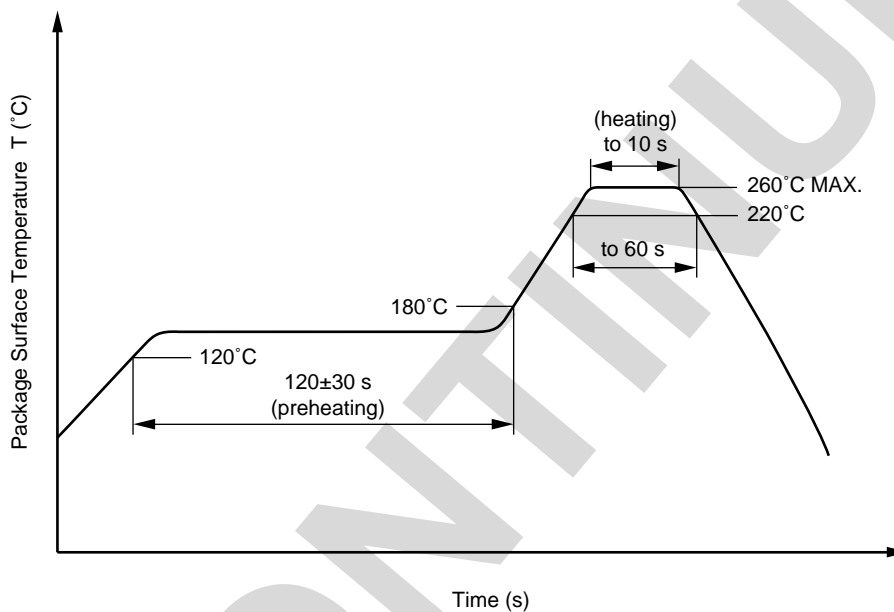

**(2) Wave soldering**

- Temperature 260°C or below (molten solder temperature)
- Time 10 seconds or less
- Preheating conditions 120°C or below (package surface temperature)
- Number of times One
- Flux Rosin flux containing small amount of chlorine (The flux with a maximum chlorine content of 0.2 Wt% is recommended.)

<R> **(3) Soldering by soldering iron**

- Peak temperature (lead part temperature) 350°C or below
- Time (each pins) 3 seconds or less
- Flux Rosin flux containing small amount of chlorine (The flux with a maximum chlorine content of 0.2 Wt% is recommended.)

- (a) Soldering of leads should be made at the point 1.5 to 2.0 mm from the root of the lead.
- (b) Please be sure that the temperature of the package would not be heated over 100°C.

**(4) Cautions**

- Fluxes  
Avoid removing the residual flux with freon-based and chlorine-based cleaning solvent.

<R> **USAGE CAUTIONS**

1. Protect against static electricity when handling.
2. Avoid storage at a high temperature and high humidity.

DISCONTINUED

- **The information in this document is current as of July, 2006. The information is subject to change without notice. For actual design-in, refer to the latest publications of NEC Electronics data sheets or data books, etc., for the most up-to-date specifications of NEC Electronics products. Not all products and/or types are available in every country. Please check with an NEC Electronics sales representative for availability and additional information.**
- No part of this document may be copied or reproduced in any form or by any means without the prior written consent of NEC Electronics. NEC Electronics assumes no responsibility for any errors that may appear in this document.
- NEC Electronics does not assume any liability for infringement of patents, copyrights or other intellectual property rights of third parties by or arising from the use of NEC Electronics products listed in this document or any other liability arising from the use of such products. No license, express, implied or otherwise, is granted under any patents, copyrights or other intellectual property rights of NEC Electronics or others.
- Descriptions of circuits, software and other related information in this document are provided for illustrative purposes in semiconductor product operation and application examples. The incorporation of these circuits, software and information in the design of a customer's equipment shall be done under the full responsibility of the customer. NEC Electronics assumes no responsibility for any losses incurred by customers or third parties arising from the use of these circuits, software and information.
- While NEC Electronics endeavors to enhance the quality, reliability and safety of NEC Electronics products, customers agree and acknowledge that the possibility of defects thereof cannot be eliminated entirely. To minimize risks of damage to property or injury (including death) to persons arising from defects in NEC Electronics products, customers must incorporate sufficient safety measures in their design, such as redundancy, fire-containment and anti-failure features.
- NEC Electronics products are classified into the following three quality grades: "Standard", "Special" and "Specific".

The "Specific" quality grade applies only to NEC Electronics products developed based on a customer-designated "quality assurance program" for a specific application. The recommended applications of an NEC Electronics product depend on its quality grade, as indicated below. Customers must check the quality grade of each NEC Electronics product before using it in a particular application.

"Standard": Computers, office equipment, communications equipment, test and measurement equipment, audio and visual equipment, home electronic appliances, machine tools, personal electronic equipment and industrial robots.

"Special": Transportation equipment (automobiles, trains, ships, etc.), traffic control systems, anti-disaster systems, anti-crime systems, safety equipment and medical equipment (not specifically designed for life support).

"Specific": Aircraft, aerospace equipment, submersible repeaters, nuclear reactor control systems, life support systems and medical equipment for life support, etc.

The quality grade of NEC Electronics products is "Standard" unless otherwise expressly specified in NEC Electronics data sheets or data books, etc. If customers wish to use NEC Electronics products in applications not intended by NEC Electronics, they must contact an NEC Electronics sales representative in advance to determine NEC Electronics' willingness to support a given application.

(Note)

- (1) "NEC Electronics" as used in this statement means NEC Electronics Corporation and also includes its majority-owned subsidiaries.
- (2) "NEC Electronics products" means any product developed or manufactured by or for NEC Electronics (as defined above).

<p><b>Caution</b></p>	<p>GaAs Products</p>	<p>This product uses gallium arsenide (GaAs). GaAs vapor and powder are hazardous to human health if inhaled or ingested, so please observe the following points.</p> <ul style="list-style-type: none"> <li>• Follow related laws and ordinances when disposing of the product. If there are no applicable laws and/or ordinances, dispose of the product as recommended below.             <ol style="list-style-type: none"> <li>1. Commission a disposal company able to (with a license to) collect, transport and dispose of materials that contain arsenic and other such industrial waste materials.</li> <li>2. Exclude the product from general industrial waste and household garbage, and ensure that the product is controlled (as industrial waste subject to special control) up until final disposal.</li> </ol> </li> <li>• Do not burn, destroy, cut, crush, or chemically dissolve the product.</li> <li>• Do not lick the product or in any way allow it to enter the mouth.</li> </ul>
-----------------------	----------------------	---

► For further information, please contact

**NEC Compound Semiconductor Devices Hong Kong Limited**

E-mail: [contact@ncsd-hk.necel.com](mailto:contact@ncsd-hk.necel.com)

Hong Kong Head Office TEL: +852-3107-7303 FAX: +852-3107-7309  
 Taipei Branch Office TEL: +886-2-8712-0478 FAX: +886-2-2545-3859  
 Korea Branch Office TEL: +82-2-558-2120 FAX: +82-2-558-5209

**NEC Electronics (Europe) GmbH** <http://www.eu.necel.com/>

TEL: +49-211-6503-0 FAX: +49-211-6503-1327

**California Eastern Laboratories, Inc.** <http://www.cel.com/>

TEL: +1-408-988-3500 FAX: +1-408-988-0279

**Compound Semiconductor Devices Division**

**NEC Electronics Corporation**

URL: <http://www.ncsd.necel.com/>

Subject: Compliance with EU Directives

CEL certifies, to its knowledge, that semiconductor and laser products detailed below are compliant with the requirements of European Union (EU) Directive 2002/95/EC Restriction on Use of Hazardous Substances in electrical and electronic equipment (RoHS) and the requirements of EU Directive 2003/11/EC Restriction on Penta and Octa BDE.

CEL Pb-free products have the same base part number with a suffix added. The suffix –A indicates that the device is Pb-free. The –AZ suffix is used to designate devices containing Pb which are exempted from the requirement of RoHS directive (\*). In all cases the devices have Pb-free terminals. All devices with these suffixes meet the requirements of the RoHS directive.

This status is based on CEL’s understanding of the EU Directives and knowledge of the materials that go into its products as of the date of disclosure of this information.

Restricted Substance per RoHS	Concentration Limit per RoHS (values are not yet fixed)	Concentration contained in CEL devices	
		-A	-AZ
Lead (Pb)	< 1000 PPM	Not Detected	(*)
Mercury	< 1000 PPM	Not Detected	
Cadmium	< 100 PPM	Not Detected	
Hexavalent Chromium	< 1000 PPM	Not Detected	
PBB	< 1000 PPM	Not Detected	
PBDE	< 1000 PPM	Not Detected	

If you should have any additional questions regarding our devices and compliance to environmental standards, please do not hesitate to contact your local representative.

**Important Information and Disclaimer:** Information provided by CEL on its website or in other communications concerning the substance content of its products represents knowledge and belief as of the date that it is provided. CEL bases its knowledge and belief on information provided by third parties and makes no representation or warranty as to the accuracy of such information. Efforts are underway to better integrate information from third parties. CEL has taken and continues to take reasonable steps to provide representative and accurate information but may not have conducted destructive testing or chemical analysis on incoming materials and chemicals. CEL and CEL suppliers consider certain information to be proprietary, and thus CAS numbers and other limited information may not be available for release.

In no event shall CEL’s liability arising out of such information exceed the total purchase price of the CEL part(s) at issue sold by CEL to customer on an annual basis.

See CEL Terms and Conditions for additional clarification of warranties and liability.