

SERIES: PEM1-S | DESCRIPTION: DC-DC CONVERTER
FEATURES

- 1 W isolated output
- smaller package
- single/dual unregulated output
- 3,000 Vdc isolation
- short circuit protection
- extended temperature range (-40~105°C)
- antistatic protection up to 8kV
- UL 60950-1 approval
- high efficiency at light load
- efficiency up to 81%



MODEL	input voltage		output voltage (Vdc)	output current		output power max (W)	ripple and noise ² typ (mVp-p)	efficiency typ (%)
	typ (Vdc)	range (Vdc)		min (mA)	max (mA)			
PEM1-S3-S3-S	3.3	2.97~3.63	3.3	30	303	1	60	73
PEM1-S3-S5-S	3.3	2.97~3.63	5	20	200	1	60	78
PEM1-S5-S3-S	5	4.5~5.5	3.3	30	303	1	60	73
PEM1-S5-S5-S ¹	5	4.5~5.5	5	20	200	1	60	80
PEM1-S5-S12-S ¹	5	4.5~5.5	12	9	83	1	60	80
PEM1-S5-S15-S ¹	5	4.5~5.5	15	7	67	1	60	81
PEM1-S5-S24-S ¹	5	4.5~5.5	24	5	42	1	60	81
PEM1-S5-D3-S	5	4.5~5.5	±3.3	±15	±152	1	60	73
PEM1-S5-D5-S ¹	5	4.5~5.5	±5	±10	±100	1	60	80
PEM1-S5-D12-S ¹	5	4.5~5.5	±12	±5	±42	1	60	80
PEM1-S5-D15-S ¹	5	4.5~5.5	±15	±4	±33	1	60	81
PEM1-S5-D24-S ¹	5	4.5~5.5	±24	±2	±21	1	60	81
PEM1-S12-S3-S	12	10.8~13.2	3.3	30	303	1	60	75
PEM1-S12-S5-S ¹	12	10.8~13.2	5	20	200	1	60	80
PEM1-S12-S12-S ¹	12	10.8~13.2	12	9	83	1	60	80
PEM1-S12-S15-S ¹	12	10.8~13.2	15	7	67	1	60	81
PEM1-S12-D3-S	12	10.8~13.2	±3.3	±15	±152	1	60	74
PEM1-S12-D5-S ¹	12	10.8~13.2	±5	±10	±100	1	60	80
PEM1-S12-D12-S ¹	12	10.8~13.2	±12	±5	±42	1	60	81
PEM1-S12-D15-S ¹	12	10.8~13.2	±15	±4	±33	1	60	81
PEM1-S15-S5-S	15	13.5~16.5	5	20	200	1	60	80
PEM1-S15-S12-S	15	13.5~16.5	12	9	83	1	60	80
PEM1-S15-S15-S	15	13.5~16.5	15	7	67	1	60	81
PEM1-S15-D5-S	15	13.5~16.5	±5	±10	±100	1	60	80
PEM1-S15-D15-S	15	13.5~16.5	±15	±4	±33	1	60	81
PEM1-S24-S3-S	24	21.6~26.4	3.3	30	303	1	60	75
PEM1-S24-S5-S ¹	24	21.6~26.4	5	20	200	1	60	79

Notes: 1. UL approved
2. Ripple and noise are measured at 20 MHz BW by "parallel cable" method with 1 μ F ceramic and 10 μ F electrolytic capacitors on the output.

**MODEL
(CONTINUED)**

	input voltage		output voltage	output current		output power	ripple and noise ²	efficiency
	typ (Vdc)	range (Vdc)	(Vdc)	min (mA)	max (mA)	max (W)	typ (mVp-p)	typ (%)
PEM1-S24-S12-S ¹	24	21.6~26.4	12	9	83	1	60	81
PEM1-S24-S15-S ¹	24	21.6~26.4	15	7	67	1	60	81
PEM1-S24-S24-S ¹	24	21.6~26.4	24	5	42	1	60	81
PEM1-S24-D3-S	24	21.6~26.4	±3.3	±15	±152	1	60	73
PEM1-S24-D5-S ¹	24	21.6~26.4	±5	±10	±100	1	60	80
PEM1-S24-D12-S ¹	24	21.6~26.4	±12	±5	±42	1	60	81
PEM1-S24-D15-S ¹	24	21.6~26.4	±15	±4	±33	1	60	79
PEM1-S24-D24-S ¹	24	21.6~26.4	±24	±2	±21	1	60	80

Notes: 1. UL approved
2. Ripple and noise are measured at 20 MHz BW by "parallel cable" method with 1 µF ceramic and 10 µF electrolytic capacitors on the output.

PART NUMBER KEY

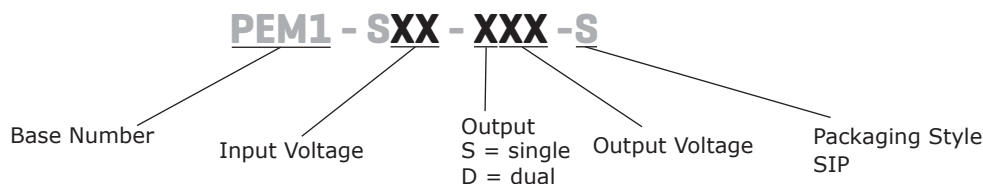

INPUT

parameter	conditions/description	min	typ	max	units
operating input voltage	3.3 Vdc input models	2.97	3.3	3.63	Vdc
	5 Vdc input models	4.5	5	5.5	Vdc
	12 Vdc input models	10.8	12	13.2	Vdc
	15 Vdc input models	13.5	15	16.5	Vdc
	24 Vdc input models	21.6	24	26.4	Vdc
surge voltage	for maximum of 1 second				
	3.3 Vdc input models	-0.7		5	Vdc
	5 Vdc input models	-0.7		9	Vdc
	12 Vdc input models	-0.7		18	Vdc
	15 Vdc input models	-0.7		21	Vdc
	24 Vdc input models	-0.7		30	Vdc
filter	capacitance filter				

OUTPUT

parameter	conditions/description	min	typ	max	units
line regulation	for Vin change of 1%				
	3.3 Vdc output models			±1.5	%
	all other models			±1.2	%
load regulation	measure from 10% load to full load				
	3.3 Vdc input models		18		%
	5 Vdc input models		12		%
	12 Vdc input models		8		%
	15 Vdc input models		7		%
	24 Vdc input models		6		%
voltage accuracy	see tolerance envelope curve				
voltage balance	dual output, balanced loads		±0.5	±1	%
switching frequency	at full load, nominal input voltage		100		kHz
temperature coefficient	at full load			±0.03	%/°C

PROTECTIONS

parameter	conditions/description	min	typ	max	units
short circuit protection ¹				1	s

Note: 1. The supply voltage must be discontinued at the end of the short circuit duration.

SAFETY AND COMPLIANCE

parameter	conditions/description	min	typ	max	units
isolation voltage	input to output for 1 minute, 1 mA max. leakage current	3,000			Vdc
isolation resistance	input to output at 500 Vdc	1,000			MΩ
isolation capacitance	input to output, 100KHz, 0.1V		20		pF
safety approvals ²	UL 60950-1				
conducted emissions	CISPR22/EN55022, class B (external circuit required, see Figure 1)				
radiated emissions	CISPR22/EN55022, class B (external circuit required, see Figure 1)				
ESD	IEC/EN61000-4-2, class B, contact ± 8kV for single outputs IEC/EN61000-4-2, class B, contact ± 6kV for dual outputs				
MTBF	as per MIL-HDBK-217F @ 25°C	3,500,000			hours
RoHS	2011/65/EU				

Note: 2. See specific models noted on pages 1 & 2.

ENVIRONMENTAL

parameter	conditions/description	min	typ	max	units
operating temperature	see derating curve	-40		105	°C
storage temperature		-55		125	°C
storage humidity	non-condensing			95	%
temperature rise	at Ta = 25°C		25		°C

SOLDERABILITY

parameter	conditions/description	min	typ	max	units
hand soldering	1.5 mm from case for 10 seconds			300	°C
wave soldering ³	see wave soldering profile			260	°C

Notes: 3. Preheat conditions: At 120°C for over 1 minute.

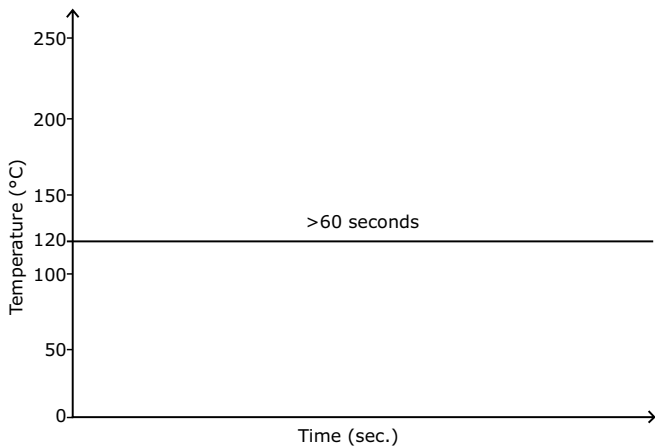

Preheat Profile

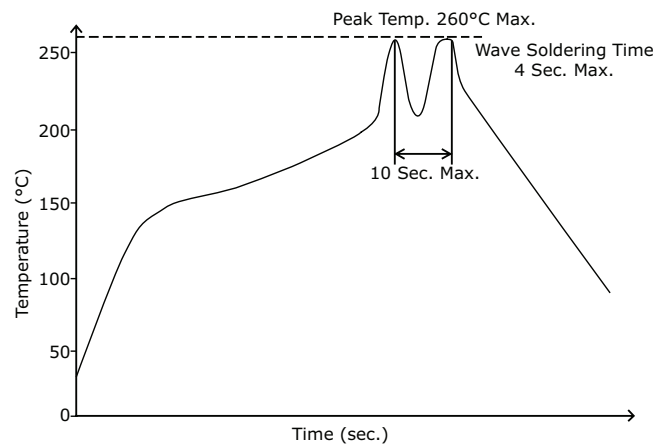

Wave Soldering Profile

MECHANICAL

parameter	conditions/description	min	typ	max	units
dimensions	19.50 x 6.00 x 9.30 (0.768 x 0.236 x 0.366 inch)				mm
case material	epoxy resin (UL94-V0)				
weight			2.4		g

MECHANICAL DRAWING

units: mm[inch]
 tolerance: $\pm 0.25[\pm 0.010]$
 pin section tolerance: $\pm 0.10[\pm 0.004]$

PIN CONNECTIONS		
PIN	Single Output	Dual Output
1	Vin	Vin
2	GND	GND
5	0V	-Vo
6	No Pin	0V
7	+Vo	+Vo

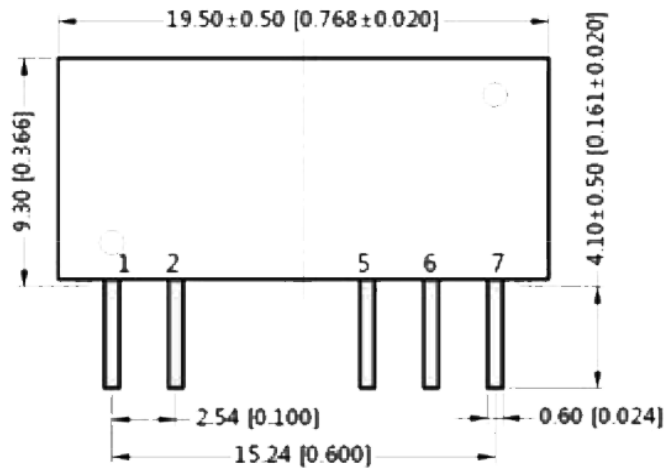

Top View

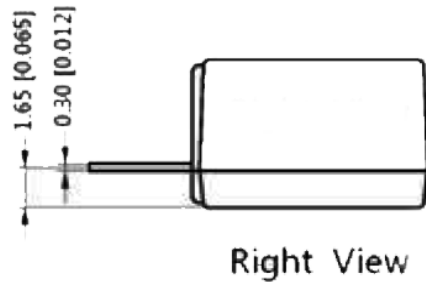

Right View

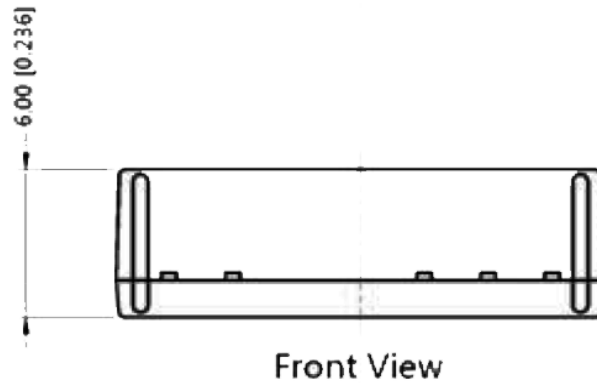

Front View

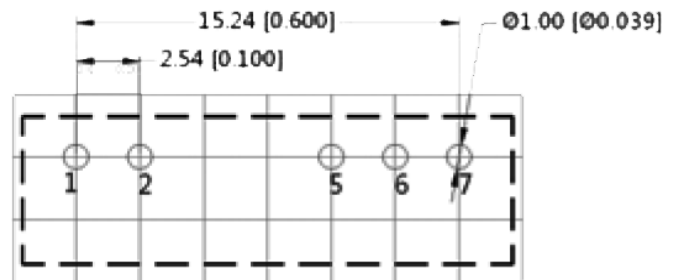

Note: Grid 2.54*2.54mm

DERATING CURVES

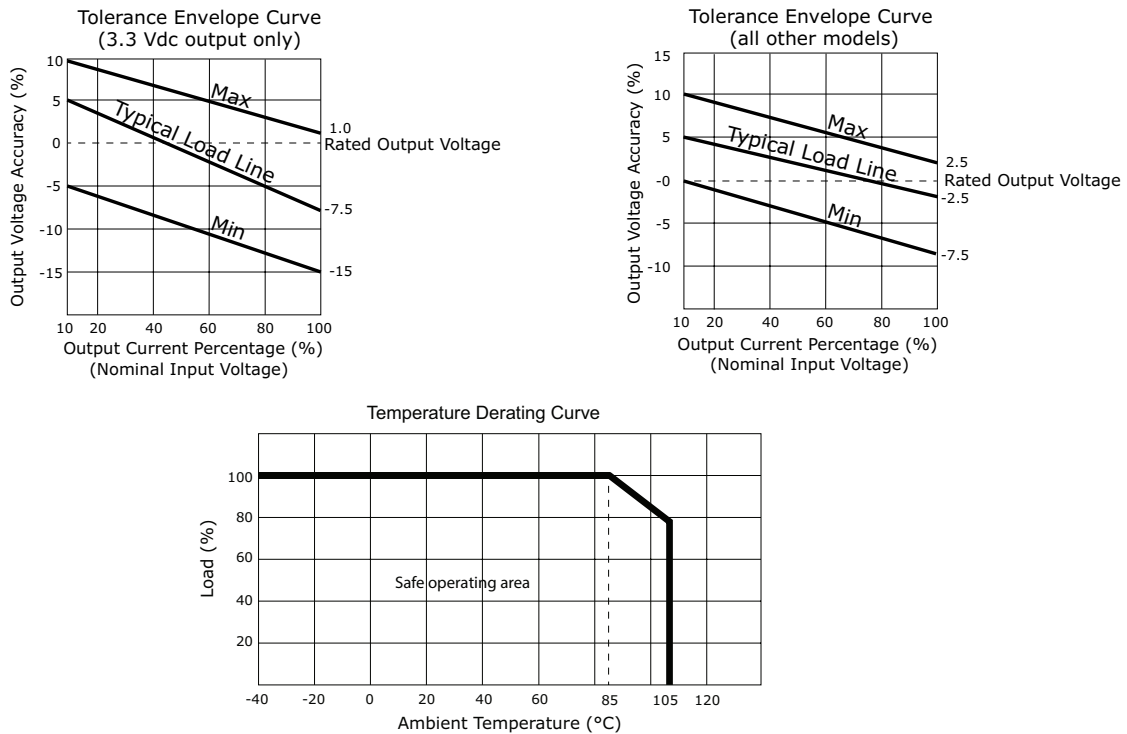

EMC RECOMMENDED CIRCUIT

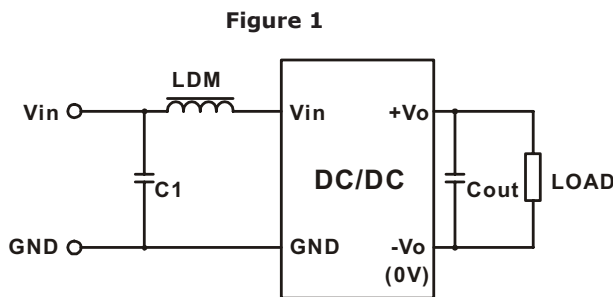

Table 1

Recommended external circuit components		
Vin (Vdc)	C1	LDM
3.3	4.7μF/50V	6.8μH
5	4.7μF/50V	6.8μH
12	4.7μF/50V	6.8μH
15	4.7μF/50V	6.8μH
24	4.7μF/50V	6.8μH

Note: 1. See Table 3 for Cout values.

TEST CONFIGURATION

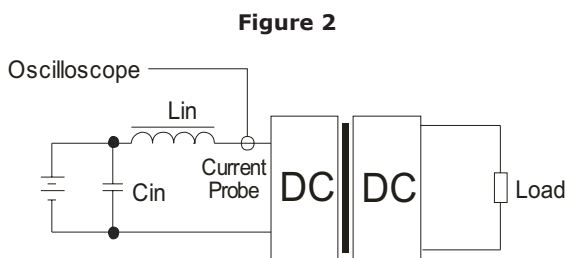

Table 2

External components	
Lin	4.7μH
Cin	220μF, ESR < 1.0Ω at 100 kHz

Note: Input reflected-ripple current is measured with an inductor Lin and Capacitor Cin to simulate source impedance.

APPLICATION NOTES

1. Output load requirement

To ensure this module can operate efficiently and reliably, the minimum output load may not be less than 10% of the full load during operation. If the actual output power is low, connect a resistor at the output end in parallel to increase the load.

2. Overload Protection

Under normal operating conditions, the output circuit of this product has no protection against overload. The simplest method to add this is to add a circuit breaker to the circuit.

3. Recommended circuit

If you want to further decrease the input/output ripple, you can increase the capacitance accordingly or choose capacitors with low ESR (see Figure 3 & Table 3). However, the capacitance of the output filter capacitor must be appropriate. If the capacitance is too high, a startup problem might arise. For every channel of the output, to ensure safe and reliable operation, the maximum capacitance must be less than the maximum capacitive load (see Table 4).

Figure 3

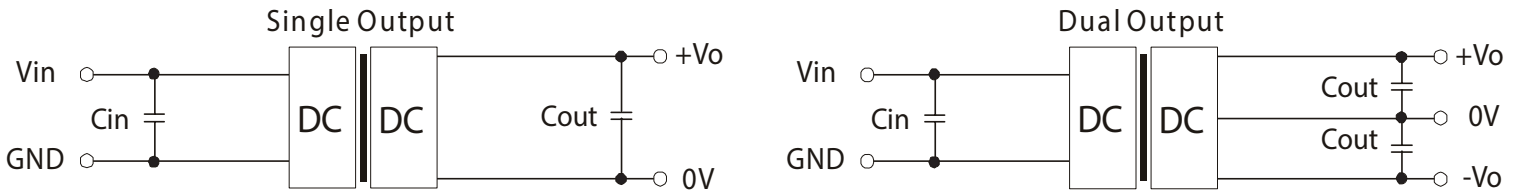

Table 3

Vin (Vdc)	Cin (μF)	Single Vo (Vdc)	Cout (μF)	Dual Vo (Vdc)	Cout (μF)
3.3	4.7	3.3	10	±3.3	4.7
5	4.7	5	10	±5	4.7
12	2.2	12	2.2	±12	1
15	2.2	15	1	±15	0.47
24	1	24	1	±24	0.47

Note: It's not recommended to connect any external capacitors in applications with less than 0.5 watt output.

Table 4

Single Vout (Vdc)	Max. Capacitive Load (μF)	Dual Vout (Vdc)	Max. Capacitive Load ¹ (μF)
3.3	220	3.3	100
5	220	5	100
12	220	12	100
15	220	15	100
24	220	24	100

Note: 1. For each output.

Note: 1. Operation under minimum load will not damage the converter; however, they may not meet all specifications listed.
 2. Max. capacitive load tested at input voltage range and full load.
 3. It is recommended to use either ceramic capacitors or electrolytic capacitors on the input and the output. Using tantalum capacitors may increase the risk of failure.
 4. All specifications measured at: Ta=25°C, humidity<75%, nominal input voltage and rated output load, unless otherwise specified.

REVISION HISTORY

rev.	description	date
1.0	initial release	03/19/2013
1.01	added model PEM1-S15-S12-S	07/29/2013
1.02	added new models	02/14/2014
1.03	added UL approval to some models	09/16/2014
1.04	added UL approval to some models	01/14/2015
1.05	updated tolerance envelope curves	02/10/2016
1.06	added wave soldering preheat conditions, updated emc recommendations	12/04/2017

The revision history provided is for informational purposes only and is believed to be accurate.

**CUI INC**[®]

Headquarters
20050 SW 112th Ave.
Tualatin, OR 97062
800.275.4899

Fax 503.612.2383
cui.com
techsupport@cui.com

CUI offers a two (2) year limited warranty. Complete warranty information is listed on our website.

CUI reserves the right to make changes to the product at any time without notice. Information provided by CUI is believed to be accurate and reliable. However, no responsibility is assumed by CUI for its use, nor for any infringements of patents or other rights of third parties which may result from its use.

CUI products are not authorized or warranted for use as critical components in equipment that requires an extremely high level of reliability. A critical component is any component of a life support device or system whose failure to perform can be reasonably expected to cause the failure of the life support device or system, or to affect its safety or effectiveness.