

**SERIES:** P78A-1000 | **DESCRIPTION:** DC-DC CONVERTER

**FEATURES**

- up to 1 A current output
- pin compatible with LM78XX linear regulators
- non-isolated switching regulator
- wide input voltage range
- efficiency up to 91%
- low ripple and noise
- short circuit protection
- ultra-compact SIP3 package
- low profile
- -40°C to +85°C temperature range



**MODEL**

MODEL	input voltage		output voltage	output current	output power	ripple & noise <sup>1</sup>	efficiency <sup>2</sup>
	typ (Vdc)	range (Vdc)	(Vdc)	max (mA)	max (W)	max (mVp-p)	typ (%)
P78A03-1000	24	7~28	3.3	1000	3.3	120	87
P78A05-1000	24	8~28	5	1000	5	120	91

Notes: 1. At full load, nominal input, 20 MHz bandwidth oscilloscope, output terminated with a 0.1 μF multilayer low ESR ceramic capacitor.  
 2. At min Vin.  
 3. All specifications measured at: Ta=25°C, nominal input voltage, rated output load, and after warm up unless otherwise specified.

**PART NUMBER KEY**

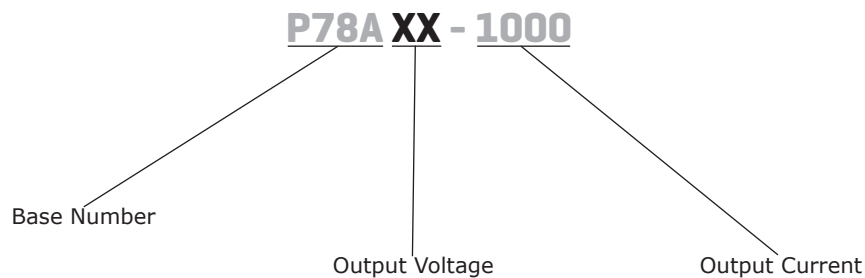

## INPUT

parameter	conditions/description	min	typ	max	units
operating input voltage	3.3 Vdc model	7	24	28	Vdc
	5 Vdc model	8	24	28	Vdc
no load input current	Vin = 24 Vdc		1.5		mA

## OUTPUT

parameter	conditions/description	min	typ	max	units
maximum capacitive load <sup>1</sup>				220	μF
line regulation	measured from low to high line, full load			±1	%
load regulation	measured from 10~100% load, typical Vin			±1.5	%
voltage accuracy			±3	±5	%
switching frequency	Vin = 12 Vdc		330		kHz

Note: 1. Maximum capacitive load is tested at nominal input voltage and full load.

## PROTECTIONS

parameter	conditions/description	min	typ	max	units
over current protection	output shut down, auto recovery			200	%
short circuit protection	output shut down, auto recovery				

## SAFETY AND COMPLIANCE

parameter	conditions/description	min	typ	max	units
MTBF	as per MIL-HDBK-217F, full load, 25 °C	3,875,000			hours
RoHS	2011/65/EU				

## ENVIRONMENTAL

parameter	conditions/description	min	typ	max	units
operating temperature	see derating curve	-40		85	°C
storage temperature		-55		125	°C
operating humidity	non-condensing			95	%

## SOLDERABILITY

parameter	conditions/description	min	typ	max	units
wave soldering	see wave solder profile			260	°C

Note: 2. The wave solder profile is measured on lead temperature.  
3. Need to keep the solder parts internal temperature less than about 210°C.

### Lead-free Recommended Soldering Profile

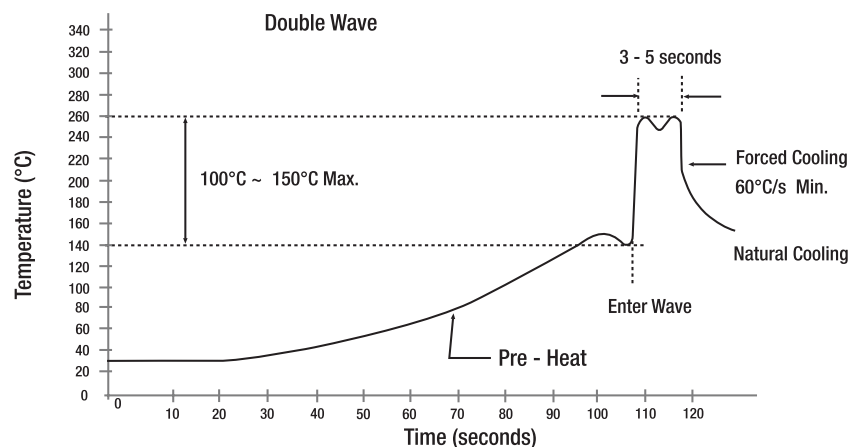

## MECHANICAL

parameter	conditions/description	min	typ	max	units
dimensions	11.6 x 8.5 x 10.4				mm
case material	non-conductive black plastic (UL94V-0)				
potting material	epoxy (UL94V-0)				
weight			2		g

## MECHANICAL DRAWING

units: mm  
 tolerance: XX.X=±0.50 mm  
 XX.XX=±0.25 mm

PIN CONNECTIONS	
PIN	Function
1	+Vin
2	GND
3	+Vout

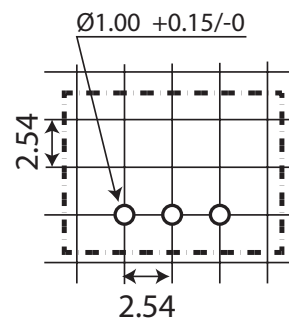
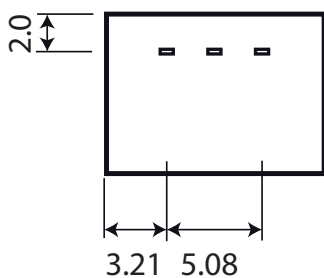
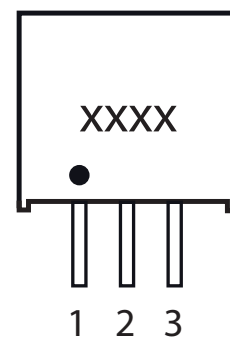
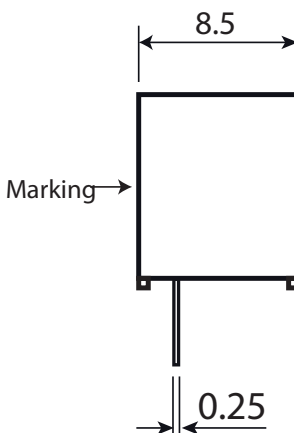
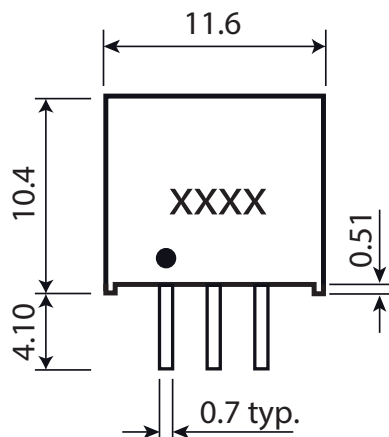

Recommended PCB Layout  
Top View

## DERATING CURVE

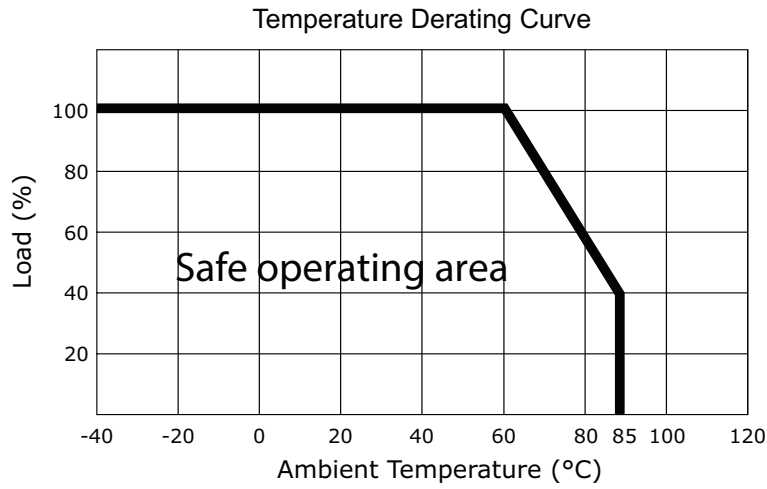

## EFFICIENCY CURVES

Efficiency vs. Load  
3.3 Vdc output model

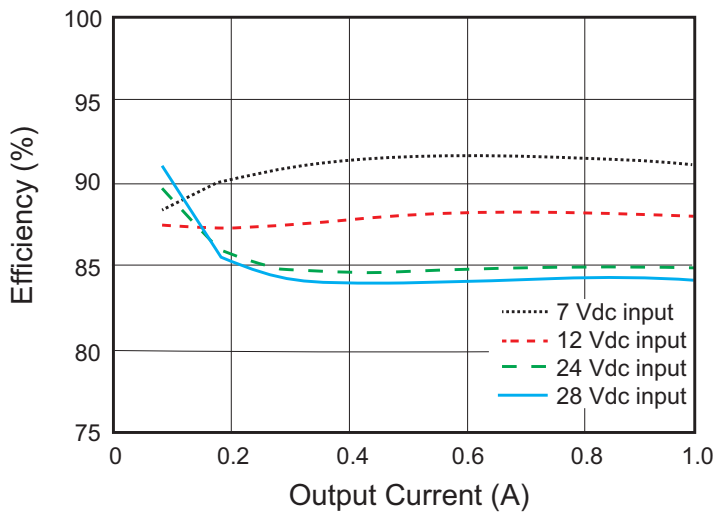

Efficiency vs. Load  
5 Vdc output model

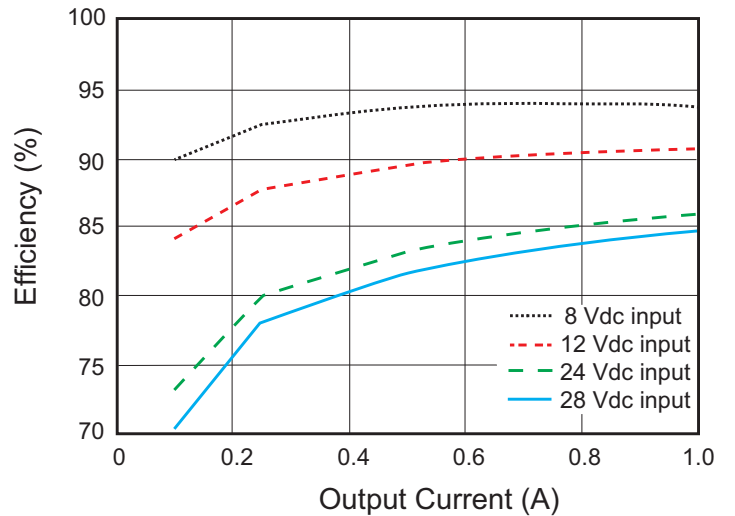

## APPLICATION CIRCUIT

Figure 1

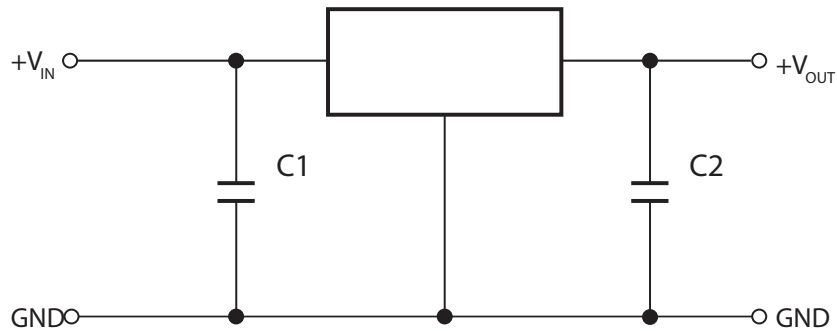

Table 1

Optional External Components	
C1	10 $\mu$ F MLCC
C2	10 $\mu$ F MLCC

- Notes:
1. To protect the converter during power-up, use soft start power supply.
  2. The converter cannot be used as a positive to negative converter.

## PACKAGING

units: mm

Tube Size: 520 x 16.5 x 9.3 mm

QTY: 42 pcs

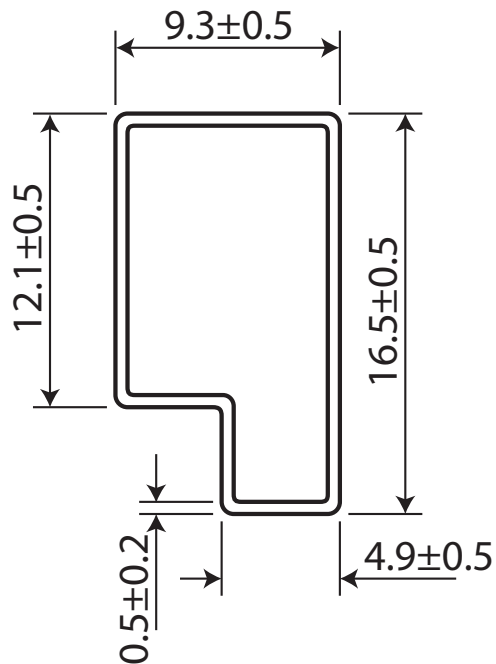

## REVISION HISTORY

---

<b>rev.</b>	<b>description</b>	<b>date</b>
1.0	initial release	05/16/2016

The revision history provided is for informational purposes only and is believed to be accurate.



**Headquarters**  
20050 SW 112th Ave.  
Tualatin, OR 97062  
**800.275.4899**

Fax 503.612.2383  
**cui.com**  
techsupport@cui.com

CUI offers a two (2) year limited warranty. Complete warranty information is listed on our website.

CUI reserves the right to make changes to the product at any time without notice. Information provided by CUI is believed to be accurate and reliable. However, no responsibility is assumed by CUI for its use, nor for any infringements of patents or other rights of third parties which may result from its use.

CUI products are not authorized or warranted for use as critical components in equipment that requires an extremely high level of reliability. A critical component is any component of a life support device or system whose failure to perform can be reasonably expected to cause the failure of the life support device or system, or to affect its safety or effectiveness.