

SERIES: NQB-N | **DESCRIPTION:** FULLY REGULATED ADVANCED BUS CONVERTERS

GENERAL CHARACTERISTICS

- industry standard footprint
- isolated topology
- high power density
- fast transient response
- high conversion efficiency
- wide range of input and output characteristics available

FEATURES

- pin and function compatible with Architects of Modern Power™ product standards
- industry standard quarter-brick 57.9 x 36.8 x 11.3 mm (2.28 x 1.45 x 0.445 in)
- industry-leading power density for telecom and datacom 127~141W / sq. in
- high efficiency, typ. 96.4% at half load, 12 Vout
- fully regulated advanced bus converter from 36~75Vin
- 2,250 Vdc input to output isolation
- fast feed forward regulation to manage line transients
- optional baseplate for high temperature applications
- droop load sharing with 10% current share accuracy
- 2.9 million hours MTBF
- ISO 9001/14001 certified supplier



MODEL	input voltage	output voltage	output current	output wattage
	(Vdc)	(Vdc)	max (A)	max (W)
NQB-420NWA-AN	36~75	12	35	420
NQB-468NMA-AN	40~60	12	39	468
NQB-415NWB-AN	36~75	12.45	35	415
NQB-462NMB-AN	40~60	12.45	39	462

PART NUMBER KEY

NQB-XXXNXX-XXXX-XXX-ESX

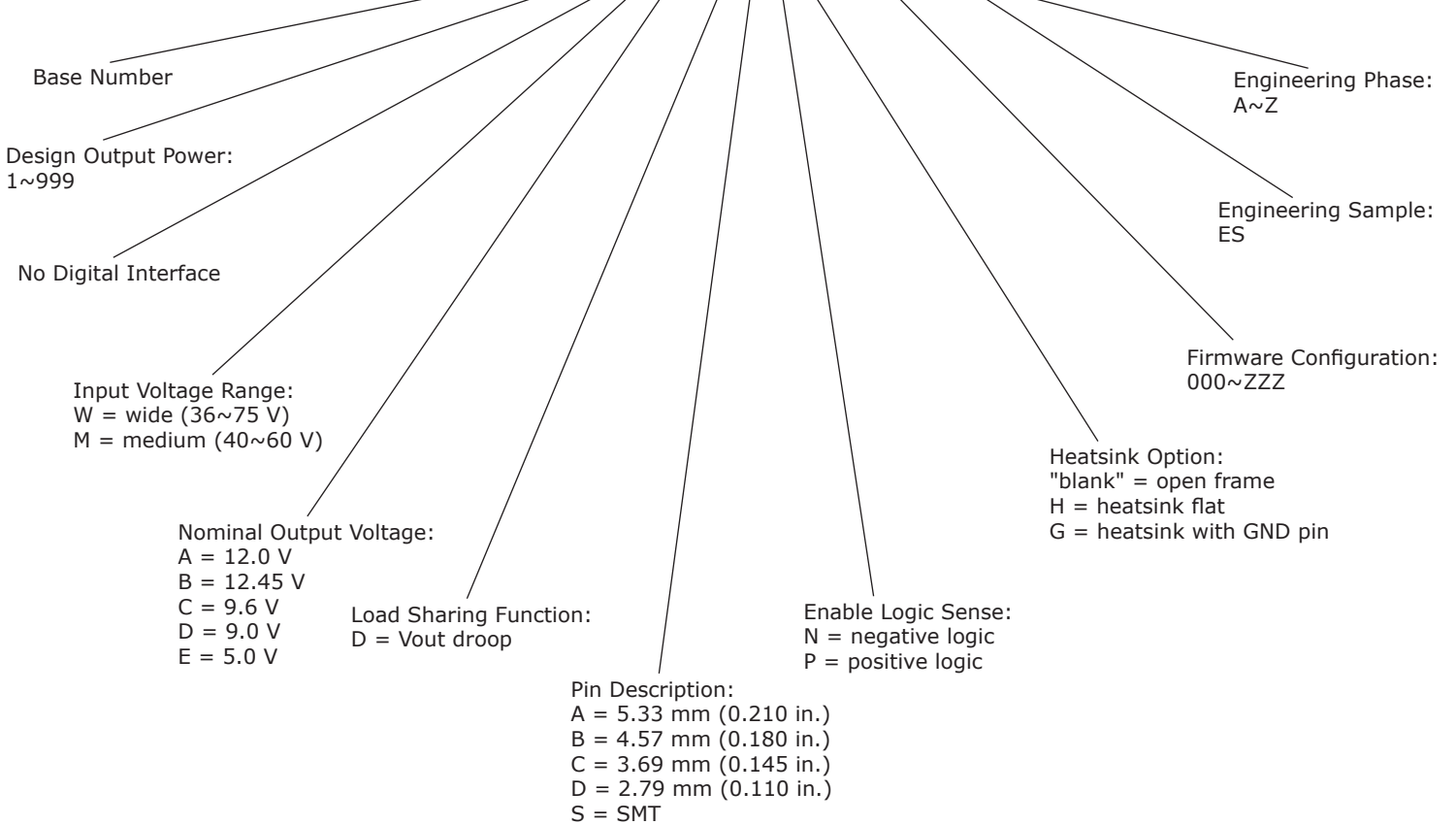

Packaging:

20 converters(through hole pin)/tray, PE foam dissipative
 20 converters(surface mount pin)/tray, Antistatic PPE

Example part number: NQB-420NWA-AN-001

420 W output power, no digital pins
 wide input voltage range, 12.0 V output
 5.33 mm pins, negative enable logic
 firmware revision 001

CONTENTS

Part Number Key.....	2	EMC Specification.....	19
General Information.....	3	Operating Information.....	19
Safety Specification.....	3	Thermal Consideration.....	21
Absolute Maximum Ratings.....	4	Connections.....	22
Electrical Specification:		Mechanical Information.....	23
12V, 35A, 420W, 36~75Vin; NQB-420NWA-AN.....	5	Soldering Information.....	26
12 V, 39 A, 468 W, 40~60 Vin; NQB-468NMA-AN.....	9	Delivery Package Information.....	27
12.45 V, 35 A, 415 W, 36~75 Vin; NQB-415NWB-AN.....	13	Product Qualification Specification.....	29
12.45 V, 39 A, 462 W, 40~60 Vin; NQB-420NMB-AN.....	16		

General Information

Reliability

The failure rate (λ) and mean time between failures (MTBF = $1/\lambda$) is calculated at max output power and an operating ambient temperature (T_A) of +40°C. CUI Power Modules uses Telcordia SR-332 Issue 2 Method 1 to calculate the mean steady-state failure rate and standard deviation (σ).

Telcordia SR-332 Issue 2 also provides techniques to estimate the upper confidence levels of failure rates based on the mean and standard deviation.

Mean steady-state failure rate, λ	Std. deviation, σ
421 n Failures/h	60.9 n Failures/h

MTBF (mean value) for the NQB series = 2.9 Mh.
MTBF at 90% confidence level = 2.4 Mh

Compatibility with RoHS requirements

The products are compatible with the relevant clauses and requirements of the RoHS directive 2011/65/EU and have a maximum concentration value of 0.1% by weight in homogeneous materials for lead, mercury, hexavalent chromium, PBB and PBDE and of 0.01% by weight in homogeneous materials for cadmium.

Exemptions in the RoHS directive utilized in CUI Power Modules products are found in the Statement of Compliance document.

Safety Specification

Reliability

CUI Power Modules DC/DC converters and DC/DC regulators are designed in accordance with the safety standards IEC 60950 1, EN 60950 1 and UL 60950 1 Safety of Information Technology Equipment.

IEC/EN/UL 60950 1 contains requirements to prevent injury or damage due to the following hazards:

- Electrical shock
- Energy hazards
- Fire
- Mechanical and heat hazards
- Radiation hazards
- Chemical hazards

On-board DC/DC converters and DC/DC regulators are defined as component power supplies. As components they cannot fully comply with the provisions of any safety requirements without "conditions of acceptability". Clearance between conductors and between conductive parts of the component power supply and conductors on the board in the final product must meet the applicable safety requirements. Certain conditions of acceptability apply for component power supplies with limited stand-off (see Mechanical Information for further information). It is the responsibility of the installer to ensure that the final product housing these components complies with

the requirements of all applicable safety standards and regulations for the final product.

Component power supplies for general use should comply with the requirements in IEC/EN/UL 60950 1 *Safety of Information Technology Equipment*. Product related standards, e.g. IEEE 802.3af *Power over Ethernet*, and ETS 300132 2 *Power interface at the input to telecom equipment, operated by direct current (dc)* are based on IEC/EN/UL 60950 1 with regards to safety.

CUI Power Modules DC/DC converters and DC/DC regulators are UL 60950 1 recognized and certified in accordance with EN 60950 1. The flammability rating for all construction parts of the products meet requirements for V 0 class material according to IEC 60695 11 10, *Fire hazard testing, test flames – 50 W horizontal and vertical flame test methods*.

Isolated DC/DC converters

Galvanic isolation between input and output is verified in an electric strength test and the isolation voltage (V_{iso}) meets the voltage strength requirement for basic insulation according to IEC/EN/UL 60950-1.

It is recommended to use a slow blow fuse at the input of each DC/DC converter. If an input filter is used in the circuit the fuse should be placed in front of the input filter. In the rare event of a component problem that imposes a short circuit on the input source, this fuse will provide the following functions:

- Isolate the fault from the input power source so as not to affect the operation of other parts of the system
- Protect the distribution wiring from excessive current and power loss thus preventing hazardous overheating

The DC/DC converter output is considered as safety extra low voltage (SELV) if one of the following conditions is met:

- The input source has double or reinforced insulation from the AC mains according to IEC/EN/UL 60950-1
- The input source has basic or supplementary insulation from the AC mains and the input of the DC/DC converter is maximum 60 Vdc and connected to protective earth according to IEC/EN/UL 60950-1
- The input source has basic or supplementary insulation from the AC mains and the DC/DC converter output is connected to protective earth according to IEC/EN/UL 60950-1

Non - isolated DC/DC regulators

The DC/DC regulator output is SELV if the input source meets the requirements for SELV circuits according to IEC/EN/UL 60950-1.

Absolute Maximum Ratings

parameter	conditions/description	min	typ	max	units
operating temperature (T_{p1})	see thermal consideration section	-40		+125	°C
storage temperature (T_s)		-55		+125	°C
input voltage (V_i)		-0.5		+80 +65*	V
isolation voltage (V_{iso})	input to output test voltage, see note 1			2250	Vdc
input voltage transient (V_{tr})	according to ETSI EN 300 132-2 and Telcordia GR-1089-CORE			+100 +80*	V
remote control pin voltage (V_{RC})	see operating information section	-0.3		18	V

Stress in excess of Absolute Maximum Ratings may cause permanent damage. Absolute Maximum Ratings, sometimes referred to as no destruction limits, are normally tested with one parameter at a time exceeding the limits of Output data or Electrical Characteristics. If exposed to stress above these limits, function and performance may degrade in an unspecified manner.

Note 1: Isolation voltage (input/output to base-plate) max 750 Vdc.
* Applies for the narrow input version $V_i = 40-60$ V

Fundamental Circuit Diagram

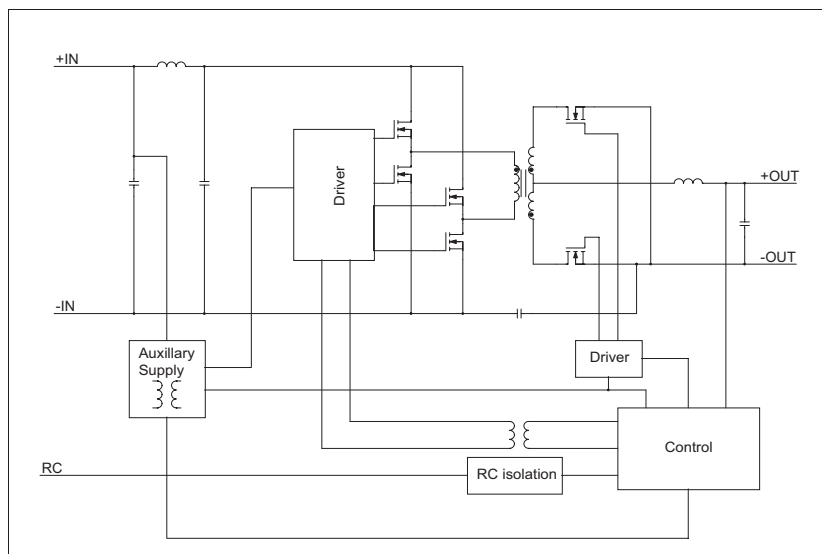

Functional Description

$T_{p1}, T_{p3} = -40$ to $+90$ °C, $V_i = 36$ to 75 V.

Typical values given at: $T_{p1}, T_{p3} = +25$ °C, $V_i = 53$ V, max I_o , unless otherwise specified under Conditions

Configuration File: 190 10-CDA 102 0314/001

parameter	conditions/description	min	typ	max	units
fault protection characteristics					
input under voltage lockout (UVLO)	fault limit		33		V
	setpoint accuracy	-2		2	%
	hysteresis		2		V
output voltage - under voltage protection	fault limit		0		V
	fault response time		200		µs
output voltage - over voltage protection	fault limit		15.6		V
	fault response time		200		µs
over current protection (OCP)	setpoint accuracy (I_o)	-6		6	%
	fault limit		41		A
	fault response time		200		µs
over temperature protection (OTP)	fault limit		125		°C
	hysteresis		10		°C
	fault response time		300		µs

Electrical Specification

12.0 V, 35 A, 420 W

$T_{P1}, T_{P3} = -40$ to $+90^{\circ}\text{C}$, $V_I = 36$ to 75 V.

Typical values given at: $T_{P1}, T_{P3} = +25^{\circ}\text{C}$, $V_I = 53$ V, max I_O , unless otherwise specified under Conditions.

Additional $C_{out} = 3.5$ mF, Configuration File: 19010-CDA 102 0314/001

parameter	conditions/description	min	typ	max	units
input voltage range (V_I)		36		75	V
turn-off input voltage (V_{Ioff})	decreasing input voltage	32	33	34	V
turn-on input voltage (V_{Ion})	increasing input voltage	34	35	36	V
internal input capacitance (C_I)			18		μF
output power (P_O)		0		420	W
efficiency (η)	50% of max I_O		96.2		%
	max I_O		95.5		%
	50% of max I_O , $V_I = 48$ V		96.4		%
	max I_O , $V_I = 48$ V		95.5		%
power dissipation (P_d)	max I_O		19.8	29.5	W
input idling power (P_{ii})	$I_O = 0$ A, $V_I = 53$ V		3.3		W
input standby power (P_{RC})	$V_I = 53$ V (turned off with RC)		0.4		W
switching frequency (f_s)	0-100% of max I_O		140		kHz
output voltage setting and accuracy (V_O)	$T_{P1} = +25^{\circ}\text{C}$, $V_I = 53$ V, $I_O = 35$ A	11.88	12.0	12.12	V
output voltage tolerance band (V_O)	0-100% of max I_O	11.76		12.24	V
line regulation (V_O)	max I_O		21	55	mV
load regulation (V_O)	$V_I = 53$ V, 0-100% of max I_O		6	40	mV
load transient voltage deviation (V_{tr})	$V_I = 53$ V, load step 25-75-25% of max I_O , $di/dt = 1$ A/ μs		± 0.4		V
load transient recovery time (t_{tr})	$V_I = 53$ V, load step 25-75-25% of max I_O , $di/dt = 1$ A/ μs		150		μs
ramp-up time (t_r) - (from 10-90% of V_{Oj})	10-100% of max I_O , $T_{P1}, T_{P3} = 25^{\circ}\text{C}$, $V_I = 53$ V		8		ms
start-up time (t_c) - (from V_I connection to 90% of V_{Oj})	10-100% of max I_O , $T_{P1}, T_{P3} = 25^{\circ}\text{C}$, $V_I = 53$ V		24		ms
V_I shut-down fall time (t_f) - (from V_I off to 10% of V_O)	max I_O $I_O = 0$ A, $C_O = 0$ mF		3.6 7		ms s
RC start-up time (t_{RC})	max I_O		12		ms
RC shut-down fall time (t_{RC}) - (from RC off to 10% of V_O)	max I_O $I_O = 0$ A, $C_O = 0$ mF		5.1 7		ms s
output current (I_O)		0		35	A
current limit threshold (I_{lim})	$V_O = 10.8$ V, $T_{P1}, T_{P3} < \max T_{P1}, T_{P3}$	37	41	44	A
short circuit current (I_{sc})	$T_{P1}, T_{P3} = 25^{\circ}\text{C}$, see Note 1		12		A
recommended capacitive load (C_{out})	$T_{P1}, T_{P3} = 25^{\circ}\text{C}$, see Note 2	0.1	3.5	6	mF
output ripple & noise (V_{Oac})	See ripple & noise section, max I_O , see Note 3		60	150	mVp-p
over voltage protection (OVP)	$T_{P1}, T_{P3} = 25^{\circ}\text{C}$, $V_I = 53$ V, 10-100% of max I_O		15.6		V
remote control (RC)	sink current (note 4), see operating information			0.7	mA
	trigger level, decreasing RC-voltage		2.6		V
	trigger level, increasing RC-voltage		2.9		V

Note

- 1: OCP in hic-up mode
- 2: Low ESR-value
- 3: $C_{out} = 100$ μF , external capacitance
- 4: Sink current drawn by external device connected to the RC pin. Minimum sink current required guaranteeing activated RC function.

Typical Characteristics
12.0 V, 35 A / 420 W

Efficiency

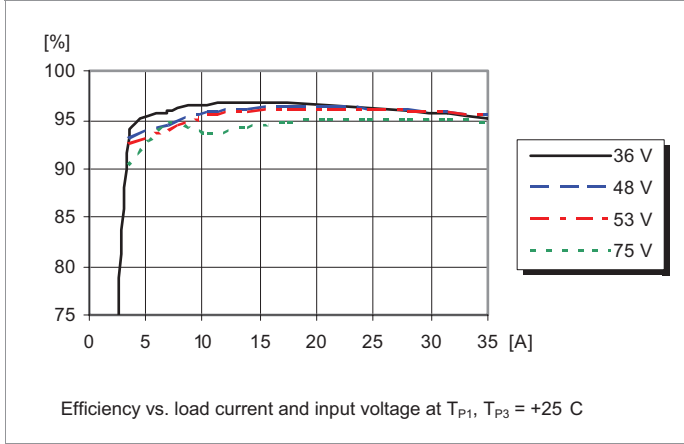

Power Dissipation

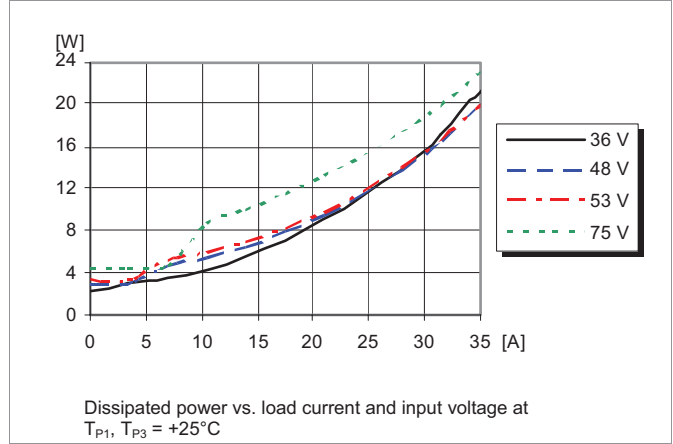

Output Characteristics

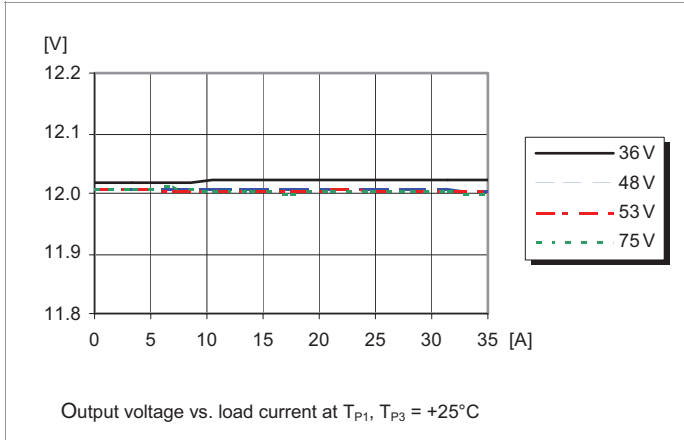

Current Limit Characteristics

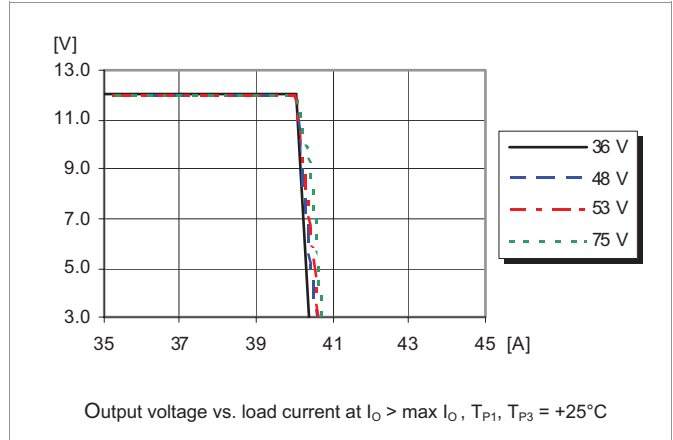

Typical Characteristics

12.0 V, 35 A / 420 W

Start-up

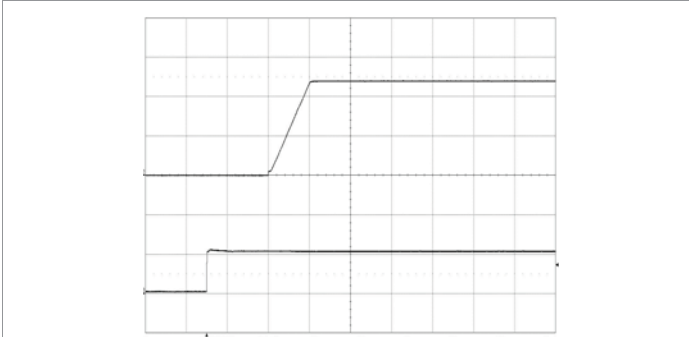

Start-up enabled by connecting V_1 at:
 $T_{P1}, T_{P3} = +25^{\circ}\text{C}$, $V_1 = 53\text{ V}$,
 $I_O = 35\text{ A}$ resistive load.
 Top trace: output voltage (5 V/div.).
 Bottom trace: input voltage (50 V/div.).
 Time scale: (10 ms/div.).

Shut-down

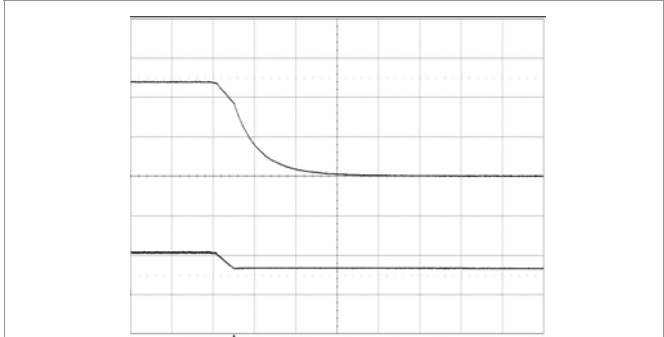

Shut-down enabled by disconnecting V_1 at:
 $T_{P1}, T_{P3} = +25^{\circ}\text{C}$, $V_1 = 53\text{ V}$,
 $I_O = 35\text{ A}$ resistive load.
 Top trace: output voltage (5 V/div.).
 Bottom trace: input voltage (50 V/div.).
 Time scale: (2 ms/div.).

Output Ripple & Noise

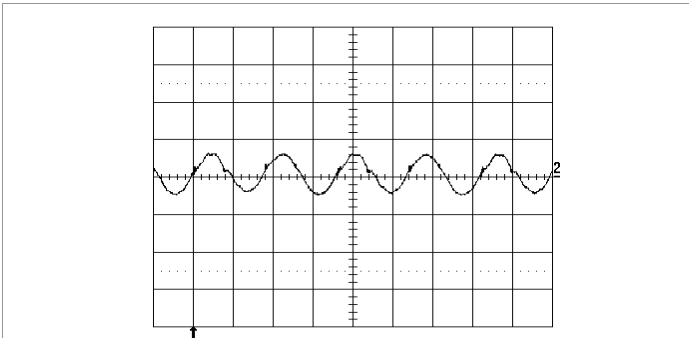

Output voltage ripple at:
 $T_{P1}, T_{P3} = +25^{\circ}\text{C}$, $V_1 = 53\text{ V}$,
 $I_O = 35\text{ A}$ resistive load.
 Trace: output voltage (50 mV/div.).
 Time scale: (2 μs /div.).

Output Load Transient Response

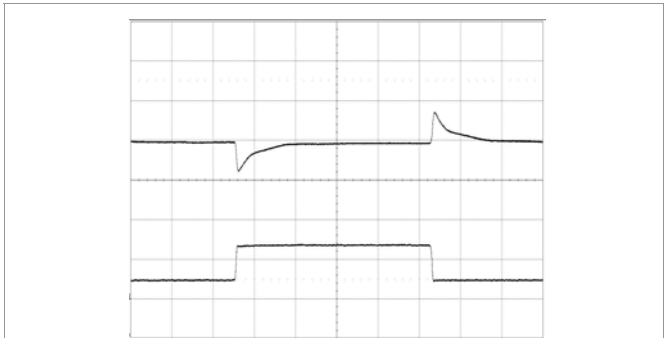

Output voltage response to load current
 step-change (8.75-26.25-8.75 A) at:
 $T_{P1}, T_{P3} = +25^{\circ}\text{C}$, $V_1 = 53\text{ V}$, $C_O = 3.5\text{ mF}$.
 Top trace: output voltage (0.5 V/div.).
 Bottom trace: output current (20 A/div.).
 Time scale: (0.5 ms/div.).

Input Voltage Transient Response

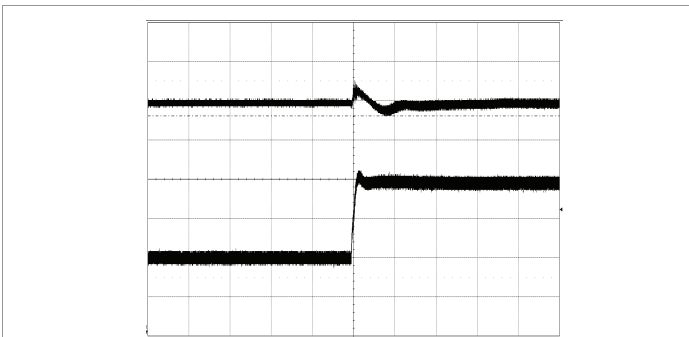

Output voltage response to input voltage
 transient at: $T_{P1}, T_{P3} = +25^{\circ}\text{C}$, $V_1 = 36-75\text{ V}$,
 $I_O = 17\text{ A}$ resistive load, $C_O = 3.5\text{ mF}$.
 Top trace: output voltage (2 V/div.).
 Bottom trace: input voltage (20 V/div.).
 Time scale: (0.5 ms/div.).

Typical Characteristics
12.0 V, 35 A / 420 W

Output Current Derating – Open frame

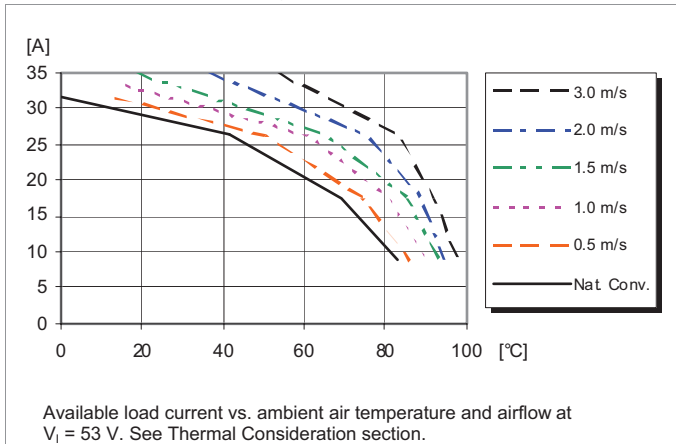

Output Current Derating – Base plate

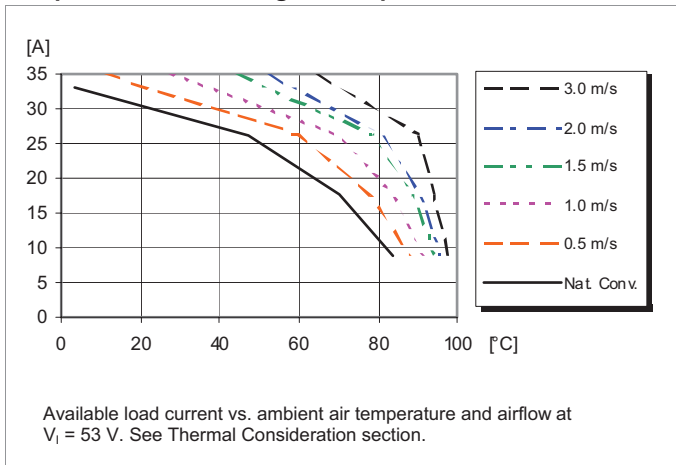

Thermal Resistance – Base plate

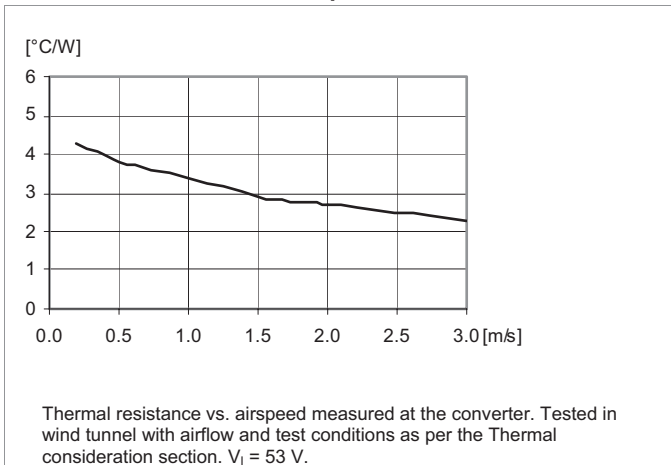

Output Current Derating – Base plate + Heat sink

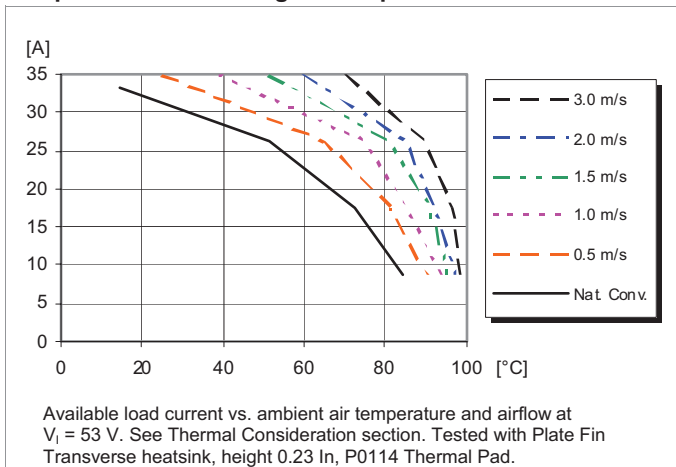

Output Current Derating – Cold wall sealed box

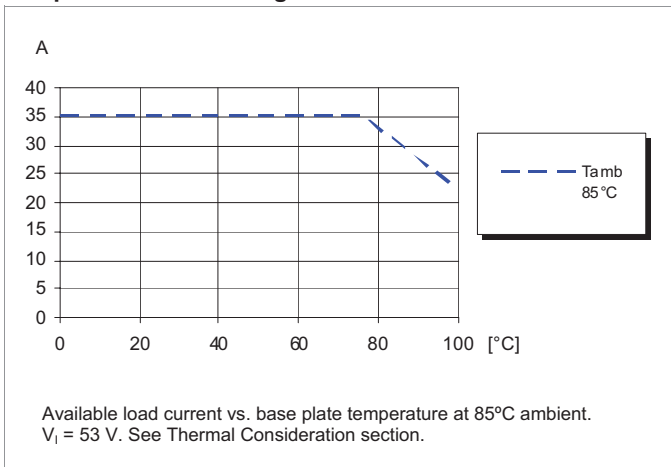

Electrical Specification

12.0 V, 39 A / 468 W

$T_{P1}, T_{P3} = -40$ to $+90^{\circ}\text{C}$, $V_I = 40$ to 60 V.

Typical values given at: $T_{P1}, T_{P3} = +25^{\circ}\text{C}$, $V_I = 53$ V, max I_O , unless otherwise specified under Conditions.

Additional $C_{out} = 3.9$ mF, Configuration File: 19010-CDA 102 0314/002

parameter	conditions/description	min	typ	max	units
input voltage range (V_I)		40		60	V
turn-off input voltage (V_{Ioff})	decreasing input voltage	36	37	38	V
turn-on input voltage (V_{Ion})	increasing input voltage	38	39	40	V
internal input capacitance (C_I)			18		μF
output power (P_O)		0		468	W
efficiency (η)	50% of max I_O		96.7		%
	max I_O		95.7		%
	50% of max I_O , $V_I = 48$ V		96.8		%
	max I_O , $V_I = 48$ V		95.6		%
power dissipation (P_d)	max I_O		21.2	30.5	W
input idling power (P_{ii})	$I_O = 0$ A, $V_I = 53$ V		2.8		W
input standby power (P_{RC})	$V_I = 53$ V (turned off with RC)		0.4		W
switching frequency (f_s)	0-100% of max I_O		140		kHz
output voltage setting and accuracy (V_{O1})	$T_{P1} = +25^{\circ}\text{C}$, $V_I = 53$ V, $I_O = 39$ A	11.88	12.0	12.12	V
output voltage tolerance band (V_O)	0-100% of max I_O	11.76		12.24	V
line regulation (V_O)	max I_O		31	60	mV
load regulation (V_O)	$V_I = 53$ V, 1-100% of max I_O		5	25	mV
load transient voltage deviation (V_{tr})	$V_I = 53$ V, load step 25-75-25% of max I_O , $di/dt = 1$ A/ μs		± 0.4		V
load transient recovery time (t_{tr})	$V_I = 53$ V, load step 25-75-25% of max I_O , $di/dt = 1$ A/ μs		150		μs
ramp-up time (t_r) - (from 10-90% of V_{O1})	10-100% of max I_O , $T_{P1} = 25^{\circ}\text{C}$, $V_I = 53$ V		8		ms
start-up time (t_s) - (from V_I connection to 90% of V_{O1})	10-100% of max I_O , $T_{P1} = 25^{\circ}\text{C}$, $V_I = 53$ V		24		ms
V_I shut-down fall time (t_f) - (from V_I off to 10% of V_O)	max I_O		3		ms
	$I_O = 0$ A, $C_O = 0$ mF		7		s
RC start-up time (t_{RC})	max I_O		12		ms
RC shut-down fall time (t_{RC}) - (from RC off to 10% of V_O)	max I_O		4.5		ms
	$I_O = 0$ A, $C_O = 0$ mF		7		s
output current (I_O)		0		39	A
current limit threshold (I_{lim})	$V_O = 10.8$ V, $T_{P1}, T_{P3} < \max T_{P1}, T_{P3}$	41	44	47	A
short circuit current (I_{sc})	$T_{P1} = 25^{\circ}\text{C}$, see Note 1		14		A
recommended capacitive load (C_{out})	$T_{P1} = 25^{\circ}\text{C}$, see Note 2	0.1	3.9	6	mF
output ripple & noise (V_{Oac})	See ripple & noise section, max I_O , see Note 3		50	110	mVp-p
over voltage protection (OVP)	$T_{P1}, T_{P3} = 25^{\circ}\text{C}$, $V_I = 53$ V, 10-100% of max I_O		15.6		V
remote control (RC)	sink current (note 4), see operating information			0.7	mA
	trigger level, decreasing RC-voltage		2.6		V
	trigger level, increasing RC-voltage		2.9		V

- Note
- 1: OCP in hic-up mode
 - 2: Low ESR-value
 - 3: $C_{out} = 100$ μF , external capacitance
 - 4: Sink current drawn by external device connected to the RC pin. Minimum sink current required guaranteeing activated RC function.

Typical Characteristics
12.0 V, 39 A / 468 W

Efficiency

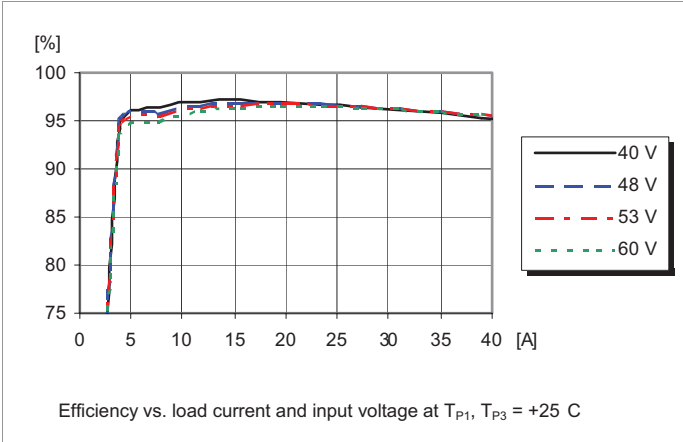

Power Dissipation

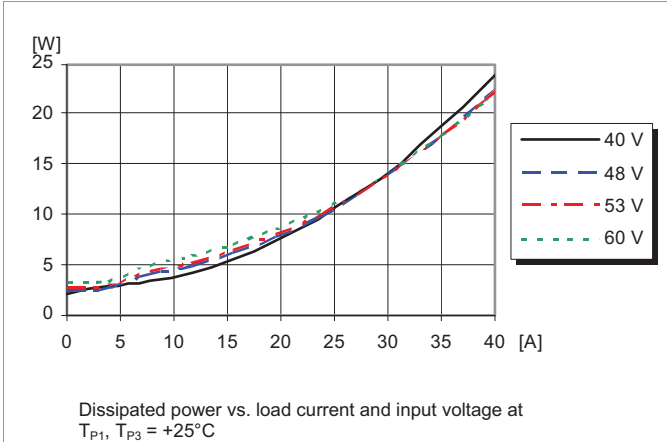

Output Characteristics

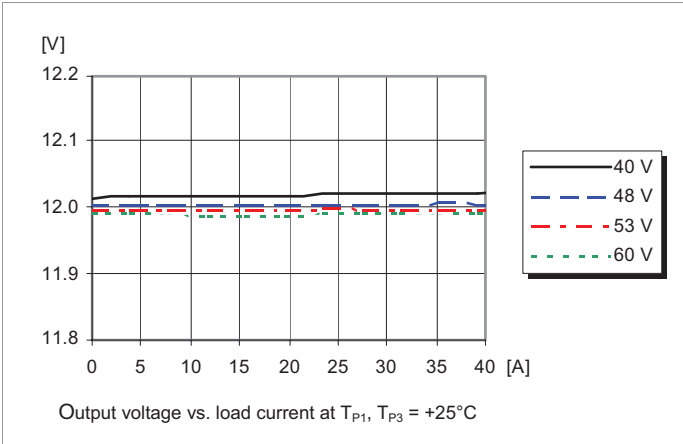

Current Limit Characteristics

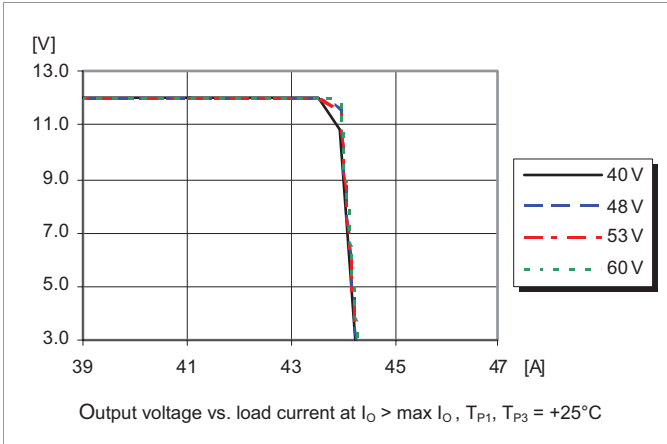

Typical Characteristics
12.0 V, 39 A / 468 W

Start-up

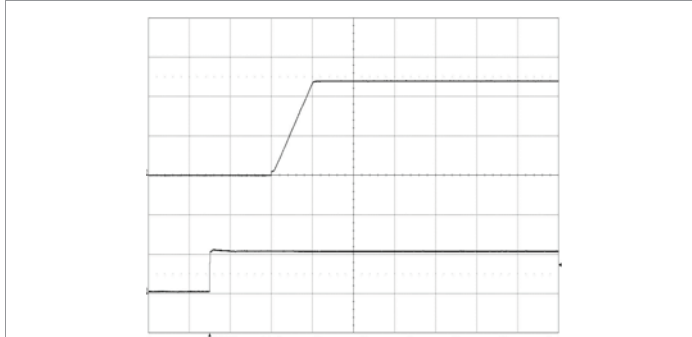

Start-up enabled by connecting V_1 at:
 $T_{P1}, T_{P3} = +25^{\circ}\text{C}, V_1 = 53\text{ V},$
 $I_O = 39\text{ A}$ resistive load.
Top trace: output voltage (5 V/div.).
Bottom trace: input voltage (50 V/div.).
Time scale: (10 ms/div.).

Shut-down

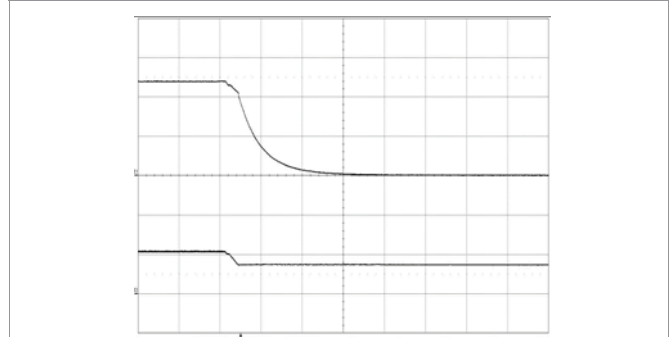

Shut-down enabled by disconnecting V_1 at:
 $T_{P1}, T_{P3} = +25^{\circ}\text{C}, V_1 = 53\text{ V},$
 $I_O = 39\text{ A}$ resistive load.
Top trace: output voltage (5 V/div.).
Bottom trace: input voltage (50 V/div.).
Time scale: (2 ms/div.).

Output Ripple & Noise

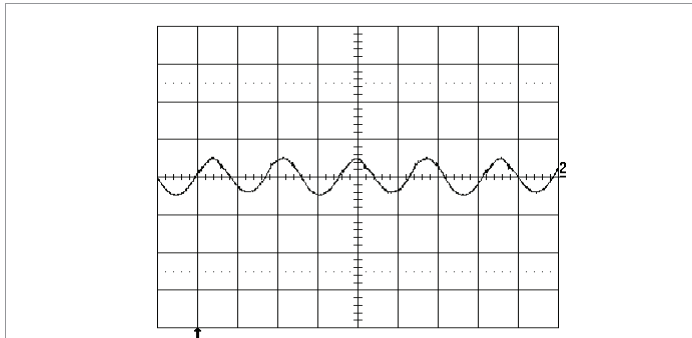

Output voltage ripple at:
 $T_{P1}, T_{P3} = +25^{\circ}\text{C}, V_1 = 53\text{ V},$
 $I_O = 39\text{ A}$ resistive load.
Trace: output voltage (50 mV/div.).
Time scale: (2 μs/div.).

Output Load Transient Response

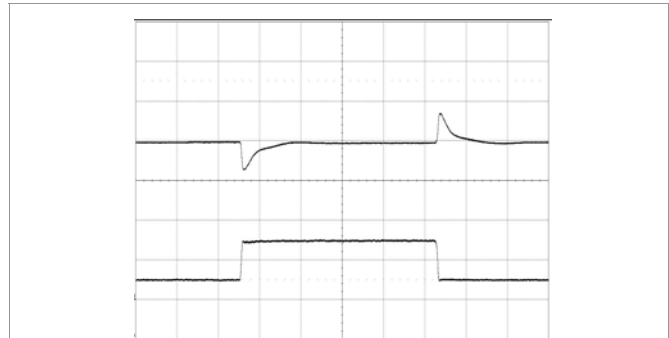

Output voltage response to load current
step-change (9.75-29.25-9.75 A) at:
 $T_{P1}, T_{P3} = +25^{\circ}\text{C}, V_1 = 53\text{ V}, C_O = 3.9\text{ mF}.$
Top trace: output voltage (0.5 V/div.).
Bottom trace: output current (20 A/div.).
Time scale: (0.5 ms/div.).

Input Voltage Transient Response

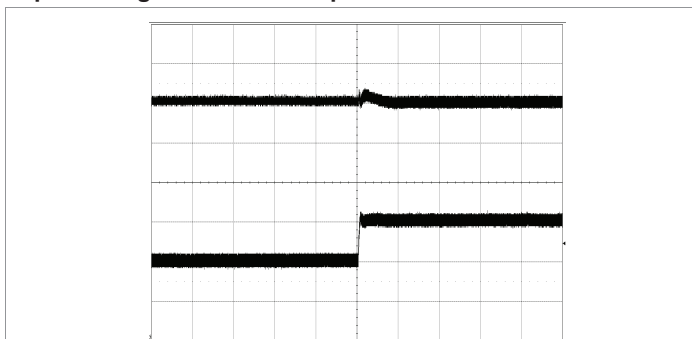

Output voltage response to input voltage
transient at: $T_{P1}, T_{P3} = +25^{\circ}\text{C}, V_1 = 40\text{-}60\text{ V},$
 $I_O = 19.5\text{ A}$ resistive load, $C_O = 3.9\text{ mF}$
Top trace: output voltage (2 V/div.).
Bottom trace: input voltage (20 V/div.).
Time scale: (0.5 ms/div.).

Typical Characteristics
12.0 V, 39 A / 468 W

Output Current Derating – Open frame

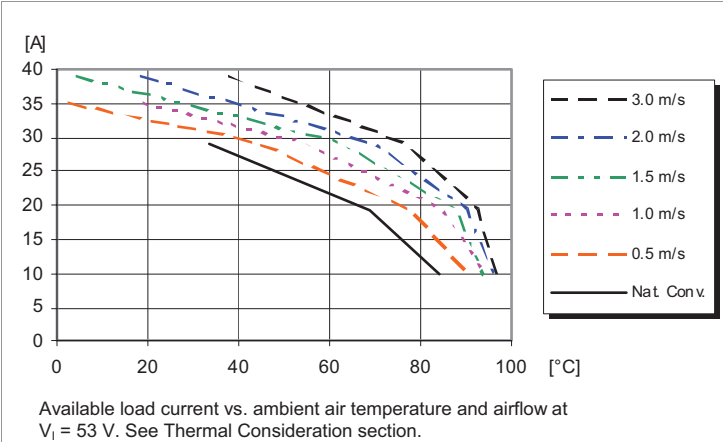

Output Current Derating – Base plate

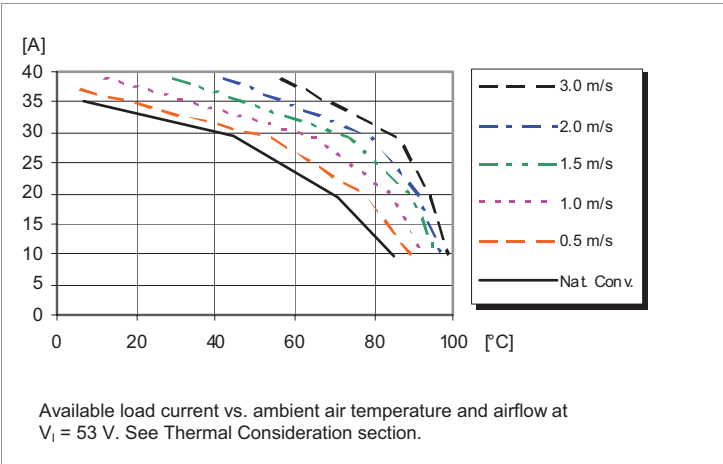

Thermal Resistance – Base plate

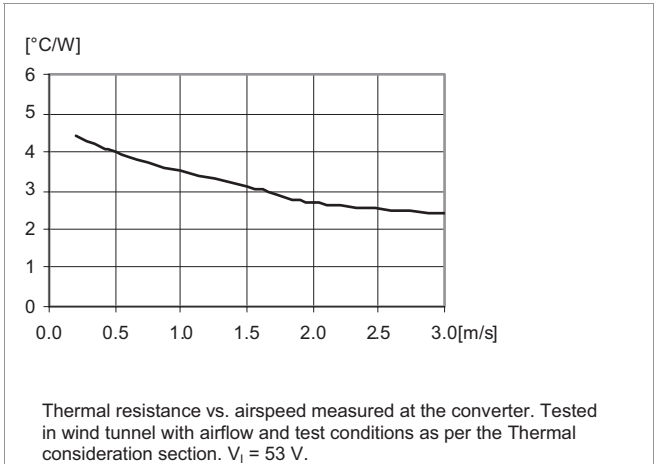

Output Current Derating – Base Plate + Heat sink

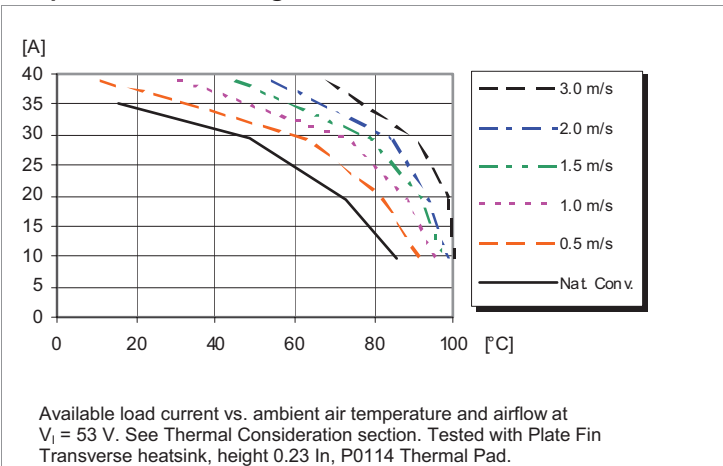

Output Current Derating – Cold wall sealed box

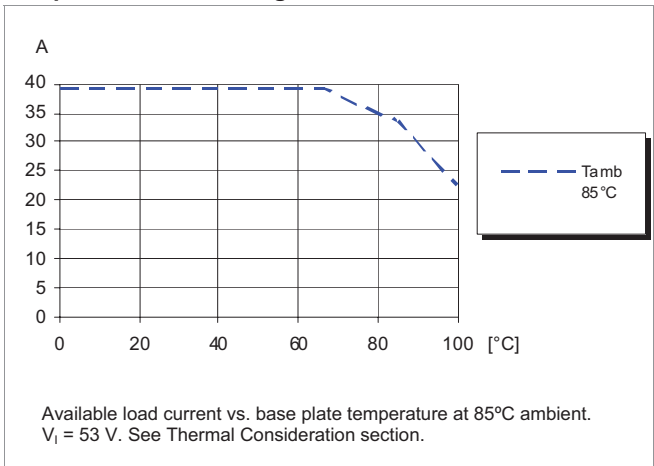

Electrical Specification

12.45 V, 35 A / 415 W

$T_{P1}, T_{P3} = -40$ to $+90^{\circ}\text{C}$, $V_I = 36$ to 75 V.

Typical values given at: $T_{P1}, T_{P3} = +25^{\circ}\text{C}$, $V_I = 53$ V, max I_O , unless otherwise specified under Conditions.

Additional $C_{out} = 3.9$ mF, Configuration File: 19010-CDA 102 0314/014

parameter	conditions/description	min	typ	max	units
input voltage range (V_I)		36		75	V
turn-off input voltage (V_{Ioff})	decreasing input voltage	32	33	34	V
turn-on input voltage (V_{Ion})	increasing input voltage	34	35	36	V
internal input capacitance (C_I)			18		μF
output power (P_O)		0		415	W
efficiency (η)	50% of max I_O		96.2		%
	max I_O		95.5		%
	50% of max I_O , $V_I = 48$ V		96.4		%
	max I_O , $V_I = 48$ V		95.5		%
power dissipation (P_d)	max I_O		19.5	29.5	W
input idling power (P_{ii})	$I_O = 0$ A, $V_I = 53$ V		3.2		W
input standby power (P_{RC})	$V_I = 53$ V (turned off with RC)		0.4		W
switching frequency (f_s)	0-100% of max I_O		140		kHz
output voltage setting and accuracy (V_{O1})	$T_{P1} = 25^{\circ}\text{C}$, $V_I = 53$ V, $I_O = 0$ A	12.415	12.45	12.485	V
output voltage tolerance band (V_O)	0-100% of max I_O	11.5		12.7	V
line regulation (V_O)	max I_O		20	55	mV
load regulation (V_O)	$V_I = 53$ V, 0-100% of max I_O	500	600	700	mV
load transient voltage deviation (V_{tr})	$V_I = 53$ V, load step 25-75-25% of max I_O , $di/dt = 1$ A/ μs		± 0.4		V
load transient recovery time (t_{tr})	$V_I = 53$ V, load step 25-75-25% of max I_O , $di/dt = 1$ A/ μs		150		μs
ramp-up time (t_r) - (from 10-90% of V_{O1})	10-100% of max I_O , $T_{P1}, T_{P3} = 25^{\circ}\text{C}$, $V_I = 53$ V		23		ms
start-up time (t_s) - (from V_I connection to 90% of V_{O1})	10-100% of max I_O , $T_{P1}, T_{P3} = 25^{\circ}\text{C}$, $V_I = 53$ V		39		ms
V_I shut-down fall time (t_f) - (from V_I off to 10% of V_O)	max I_O		3.6		ms
	$I_O = 0$ A, $C_O = 0$ mF		7		s
RC start-up time (t_{RC})	max I_O		27		ms
RC shut-down fall time (t_{RC}) - (from RC off to 10% of V_O)	max I_O		5.1		ms
	$I_O = 0$ A, $C_O = 0$ mF		7		s
output current (I_O)		0		35	A
current limit threshold (I_{lim})	$V_O = 10.8$ V, $T_{P1}, T_{P3} < \max T_{P1}, T_{P3}$	37	41	44	A
short circuit current (I_{sc})	$T_{P1}, T_{P3} = 25^{\circ}\text{C}$, see Note 1		12		A
recommended capacitive load (C_{out})	$T_{P1}, T_{P3} = 25^{\circ}\text{C}$, see Note 2	0.1	3.5	6	mF
output ripple & noise (V_{Oac})	See ripple & noise section, max I_O , see Note 3		60	150	mVp-p
over voltage protection (OVP)	$T_{P1}, T_{P3} = 25^{\circ}\text{C}$, $V_I = 53$ V, 10-100% of max I_O		15.6		V
remote control (RC)	sink current (note 4), see operating information trigger level, decreasing RC-voltage trigger level, increasing RC-voltage			0.7	mA
			2.6		V
			2.9		V

- Note
- 1: OCP in hic-up mode
 - 2: Low ESR-value
 - 3: $C_{out} = 100$ μF , external capacitance
 - 4: Sink current drawn by external device connected to the RC pin. Minimum sink current required guaranteeing activated RC function.

Typical Characteristics 12.45 V, 63 A / 747 W, two products in parallel

Efficiency

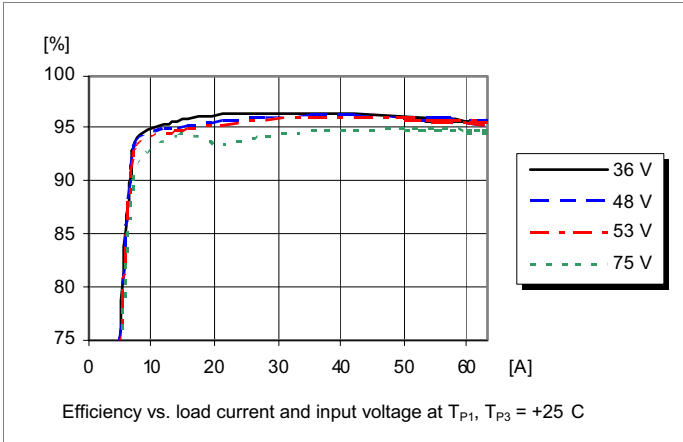

Power Dissipation

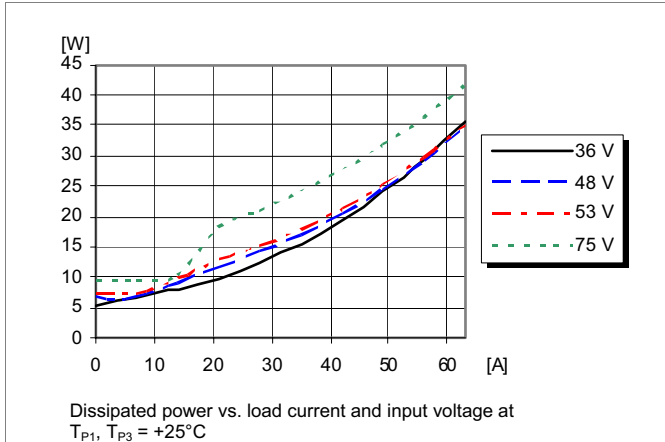

Output Characteristics

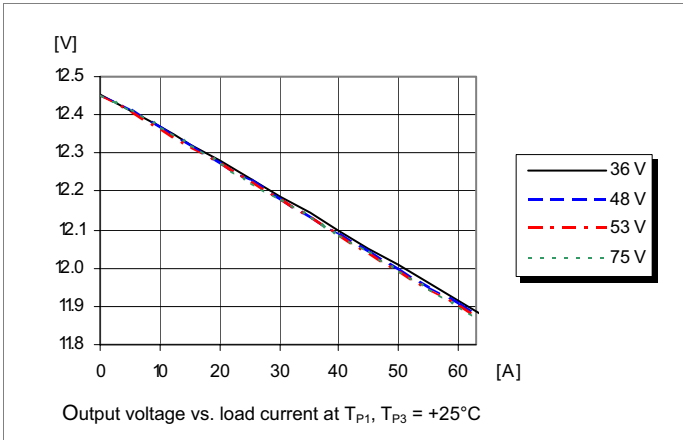

Current Limit Characteristics

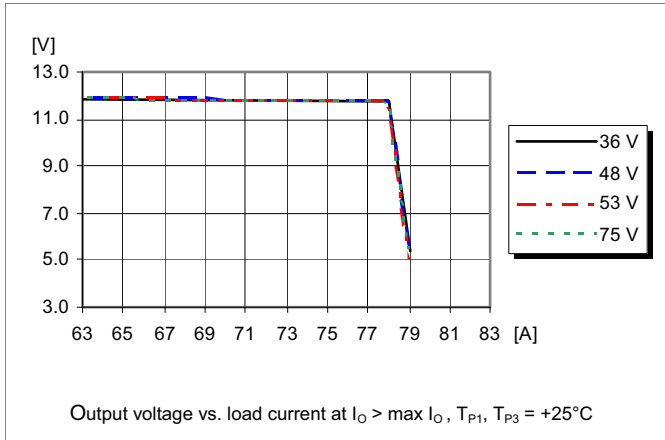

Start-up

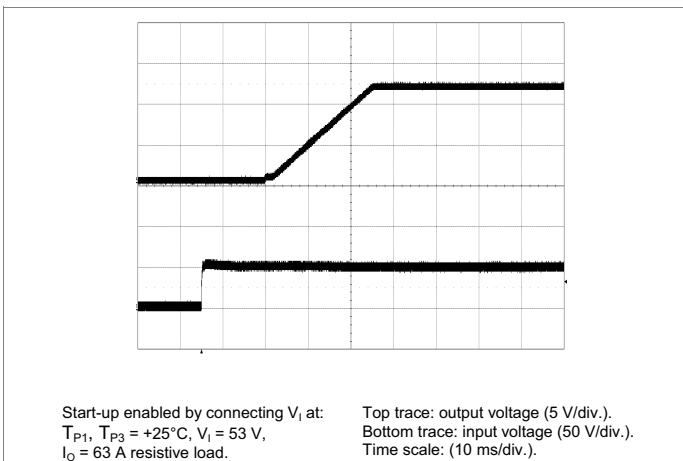

Output Load Transient Response

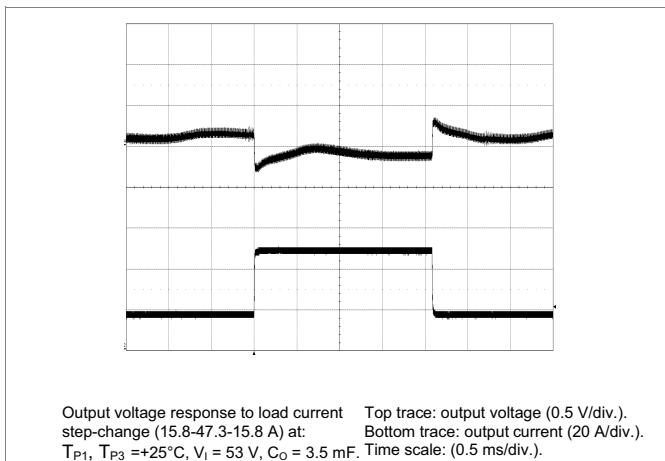

Typical Characteristics
12.45 V, 35 A / 415 W

Output Current Derating – Open frame

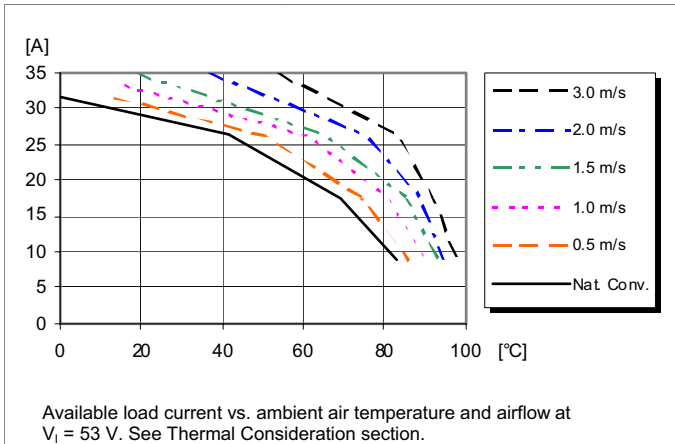

Output Current Derating – Base plate

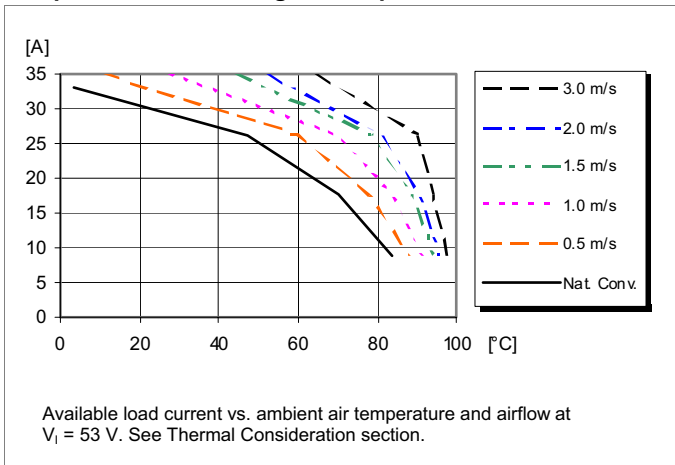

Thermal Resistance – Base plate

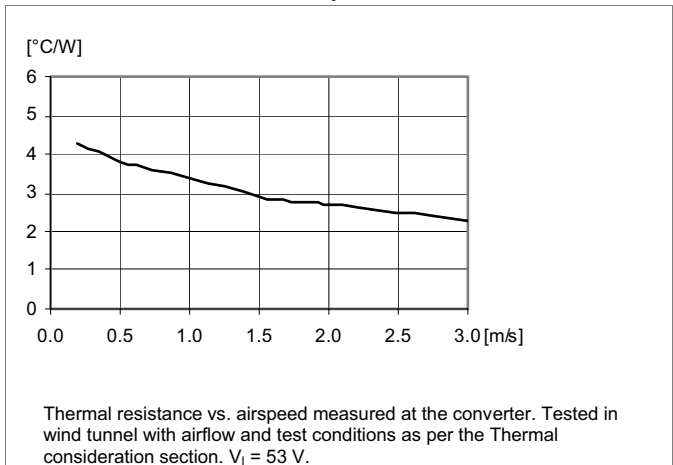

Output Current Derating – Base plate + Heat sink

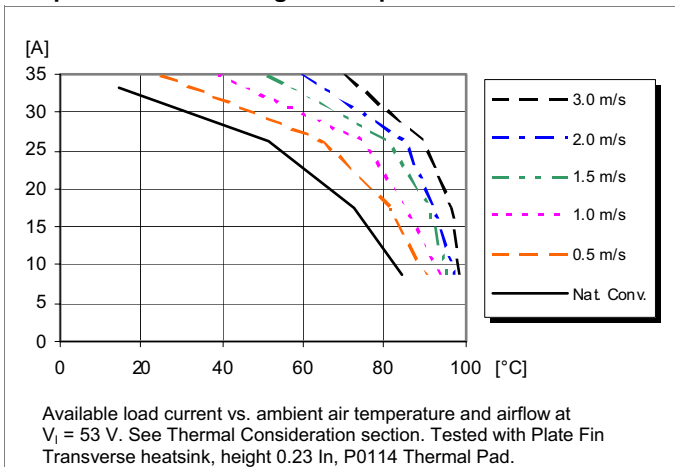

Output Current Derating – Cold wall sealed box

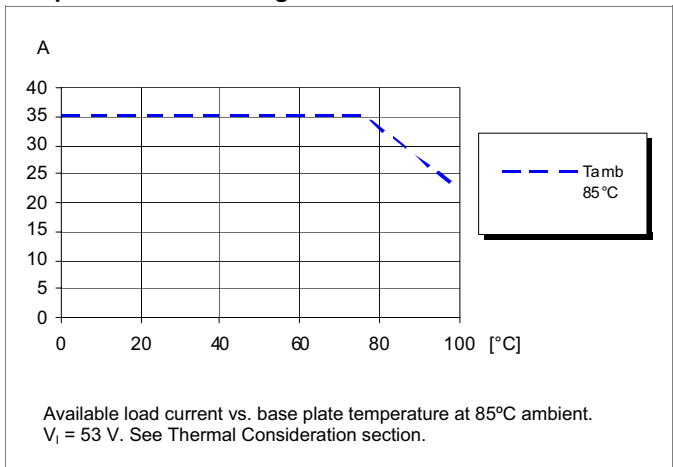

Electrical Specification

12.45 V, 39 A / 462 W

$T_{P1}, T_{P3} = -40$ to $+90^{\circ}\text{C}$, $V_I = 40$ to 60 V.

Typical values given at: $T_{P1}, T_{P3} = +25^{\circ}\text{C}$, $V_I = 53$ V, max I_O , unless otherwise specified under Conditions.

Additional $C_{out} = 3.9$ mF, Configuration File: 19010-CDA 102 0314/017

parameter	conditions/description	min	typ	max	units
input voltage range (V_I)		40		60	V
turn-off input voltage (V_{Ioff})	decreasing input voltage	36	37	38	V
turn-on input voltage (V_{Ion})	increasing input voltage	38	39	40	V
internal input capacitance (C_I)			18		μF
output power (P_O)		0		462	W
efficiency (η)	50% of max I_O		96.7		%
	max I_O		95.7		%
	50% of max I_O , $V_I = 48$ V		96.8		%
	max I_O , $V_I = 48$ V		95.6		%
power dissipation (P_d)	max I_O		21.0	30.5	W
input idling power (P_{ii})	$I_O = 0$ A, $V_I = 53$ V		2.8		W
input standby power (P_{RC})	$V_I = 53$ V (turned off with RC)		0.4		W
switching frequency (f_s)	0-100% of max I_O		140		kHz
output voltage setting and accuracy (V_{O1})	$T_{P1} = 25^{\circ}\text{C}$, $V_I = 53$ V, $I_O = 0$ A	12.415	12.45	12.485	V
output voltage tolerance band (V_O)	0-100% of max I_O	11.5		12.7	V
line regulation (V_O)	max I_O		31	60	mV
load regulation (V_O)	$V_I = 53$ V, 0-100% of max I_O	500	600	700	mV
load transient voltage deviation (V_{tr})	$V_I = 53$ V, load step 25-75-25% of max I_O , $di/dt = 1$ A/ μs		± 0.4		V
load transient recovery time (t_{tr})	$V_I = 53$ V, load step 25-75-25% of max I_O , $di/dt = 1$ A/ μs		150		μs
ramp-up time (t_r) - (from 10-90% of V_{O1})	10-100% of max I_O , $T_{P1} = 25^{\circ}\text{C}$, $V_I = 53$ V		23		ms
start-up time (t_s) - (from V_I connection to 90% of V_{O1})	10-100% of max I_O , $T_{P1} = 25^{\circ}\text{C}$, $V_I = 53$ V		39		ms
V_I shut-down fall time (t_f) - (from V_I off to 10% of V_O)	max I_O		3		ms
	$I_O = 0$ A, $C_O = 0$ mF		7		s
RC start-up time (t_{RC})	max I_O		27		ms
RC shut-down fall time (t_{RC}) - (from RC off to 10% of V_O)	max I_O		4.5		ms
	$I_O = 0$ A, $C_O = 0$ mF		7		s
output current (I_O)		0		39	A
current limit threshold (I_{lim})	$V_O = 10.8$ V, $T_{P1}, T_{P3} < \max T_{P1}, T_{P3}$	41	44	47	A
short circuit current (I_{sc})	$T_{P1} = 25^{\circ}\text{C}$, see Note 1		14		A
recommended capacitive load (C_{out})	$T_{P1} = 25^{\circ}\text{C}$, see Note 2	0.1	3.9	6	mF
output ripple & noise (V_{Oac})	See ripple & noise section, max I_O , see Note 3		50	110	mVp-p
over voltage protection (OVP)	$T_{P1}, T_{P3} = 25^{\circ}\text{C}$, $V_I = 53$ V, 10-100% of max I_O		15.6		V
remote control (RC)	sink current (note 4), see operating information trigger level, decreasing RC-voltage trigger level, increasing RC-voltage			0.7	mA
			2.6		V
			2.9		V

- Note
- 1: OCP in hic-up mode
 - 2: Low ESR-value
 - 3: $C_{out} = 100$ μF , external capacitance
 - 4: Sink current drawn by external device connected to the RC pin. Minimum sink current required guaranteeing activated RC function.

Typical Characteristics
12.45 V, 70 A / 830 W, two products in parallel

Efficiency

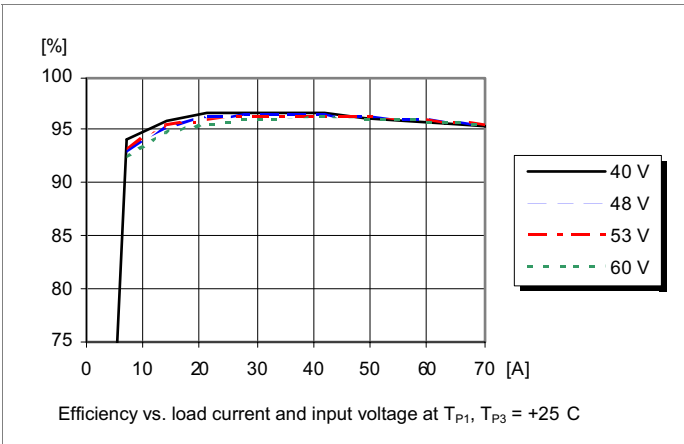

Power Dissipation

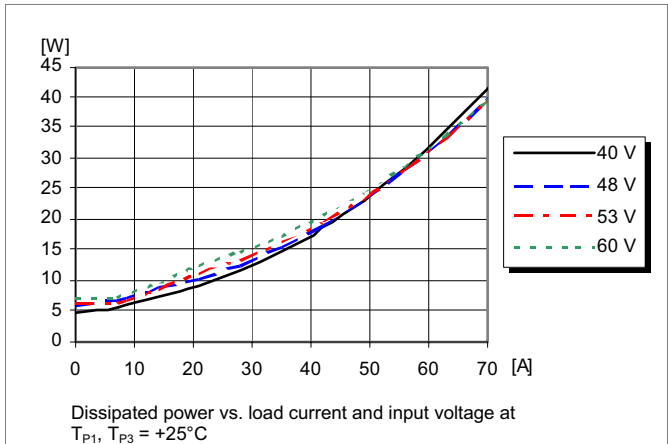

Output Characteristics

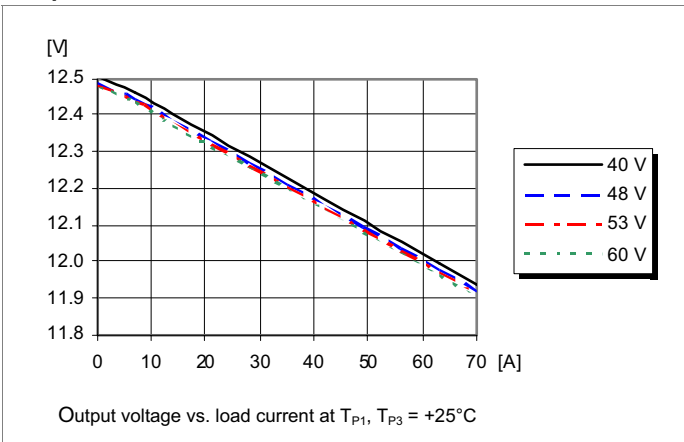

Current Limit Characteristics

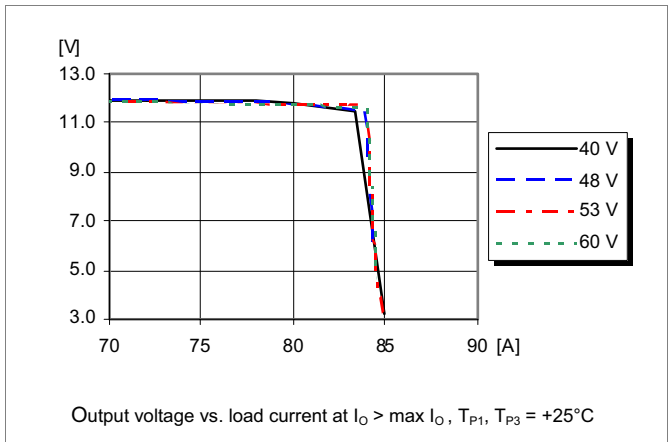

Start-up

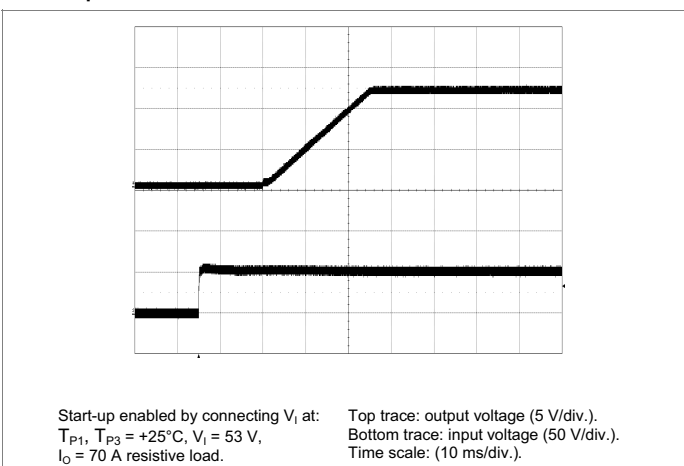

Output Load Transient Response

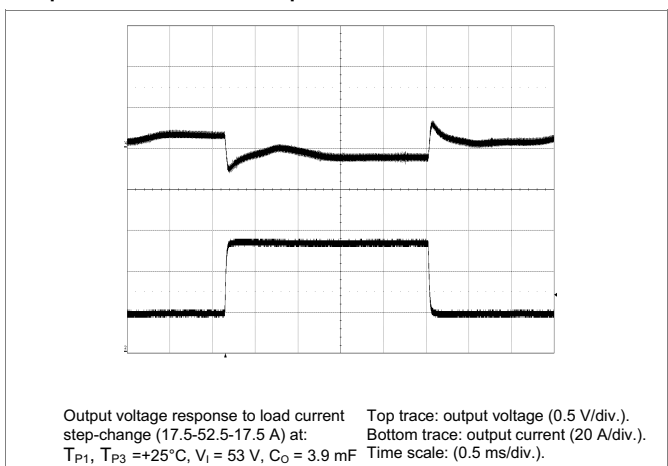

Typical Characteristics
12.45 V, 39 A / 462 W

Output Current Derating – Open frame

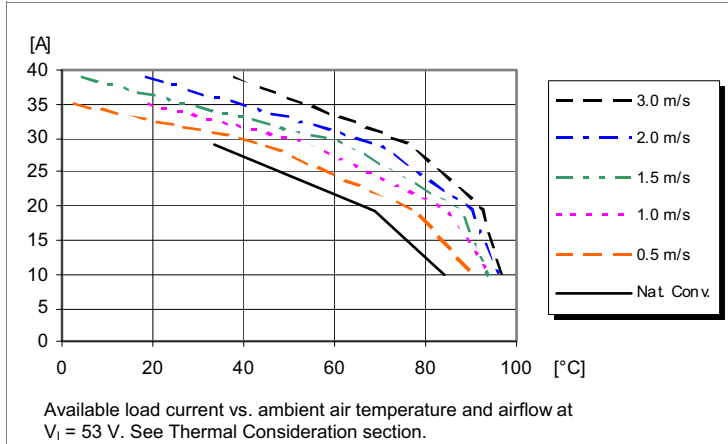

Output Current Derating – Base plate

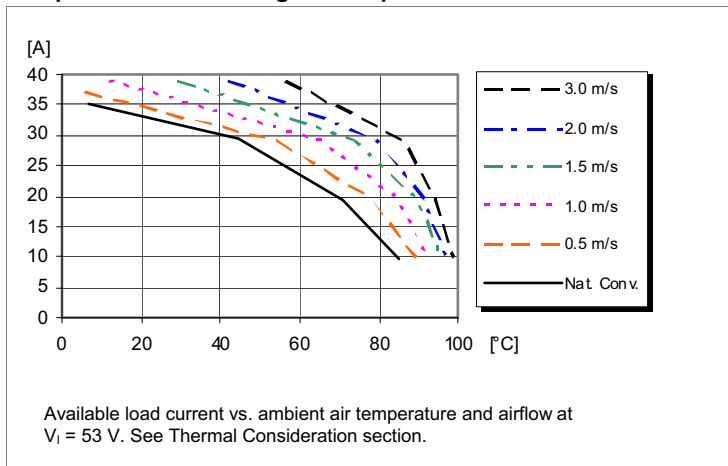

Thermal Resistance – Base plate

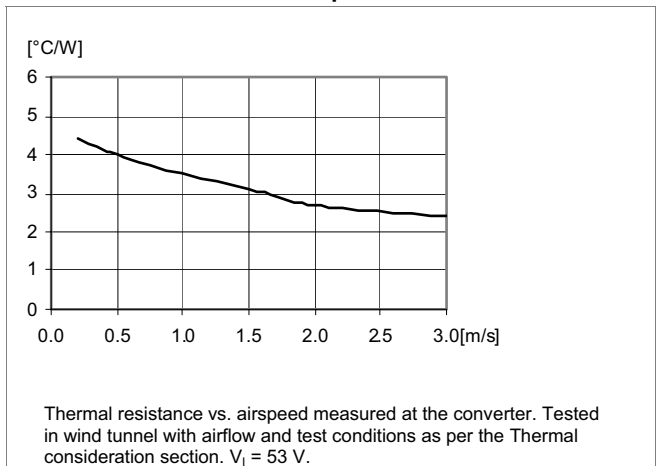

Output Current Derating – Base Plate + Heat sink

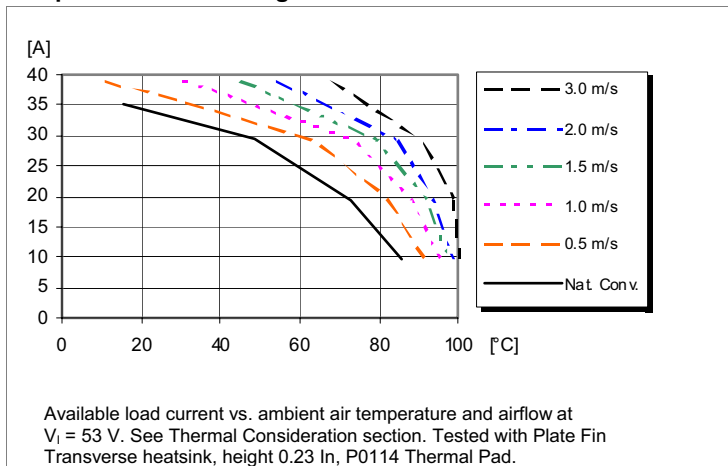

Output Current Derating – Cold wall sealed box

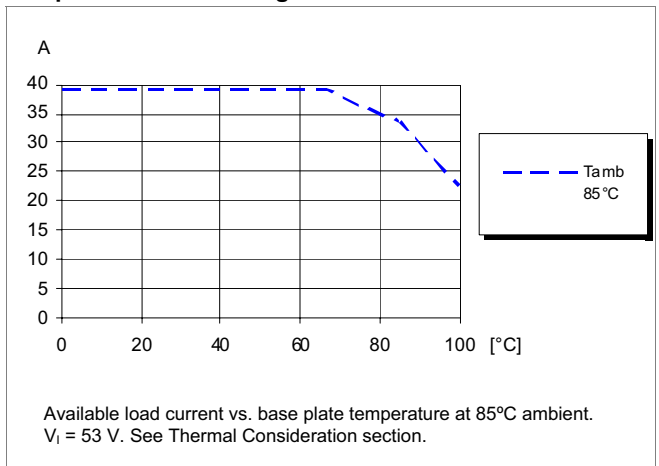

EMC Specification

Conducted EMI measured according to EN55022, CISPR 22 and FCC part 15J (see test set-up). The fundamental switching frequency is 140 kHz for NQB at $V_I = 53\text{ V}$, max I_O .

Conducted EMI Input terminal value (typ)

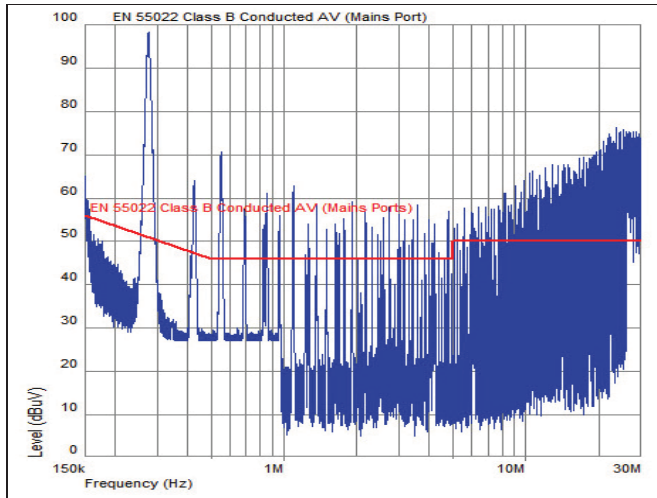

EMI without filter

Optional external filter for class B

Suggested external input filter in order to meet class B in EN 55022, CISPR 22 and FCC part 15J.

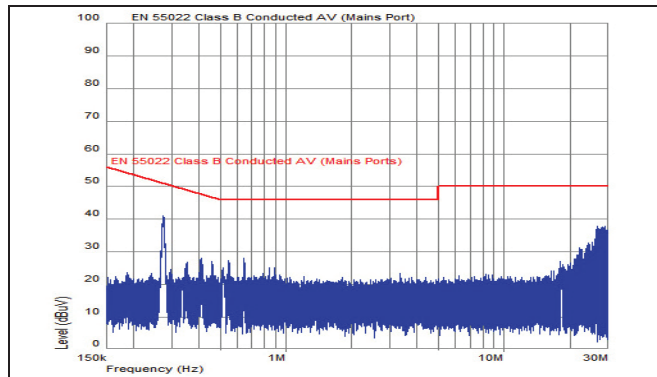
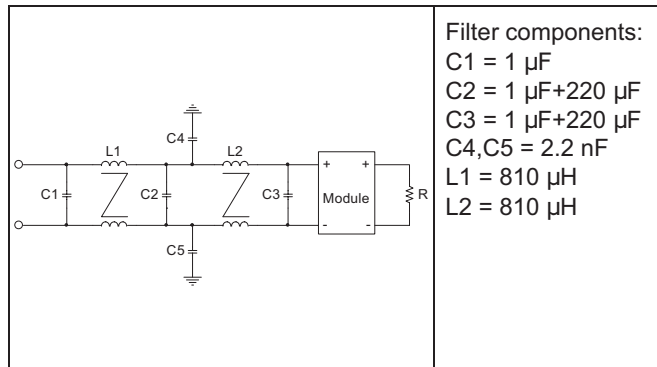

EMI with filter

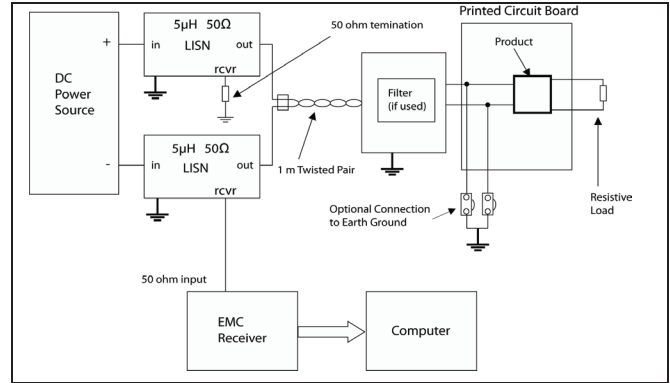

Test set-up

Layout recommendations

The radiated EMI performance of the product will depend on the PWB layout and ground layer design. It is also important to consider the stand-off of the product. If a ground layer is used, it should be connected to the output of the product and the equipment ground or chassis.

A ground layer will increase the stray capacitance in the PWB and improve the high frequency EMC performance.

Output ripple and noise

Output ripple and noise measured according to figure below.

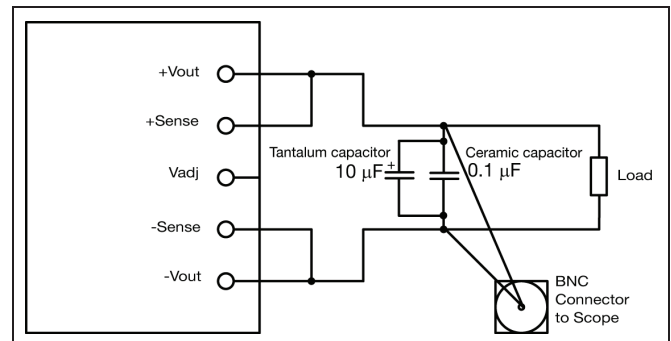

Output ripple and noise test setup

Operating information

Power Management Overview

This product includes protection features that continuously safeguard the load from damage due to unexpected system faults.

Input Voltage

The NQB consists of two different product families designed for two different input voltage ranges, 36 to 75 Vdc and 40 to 60 Vdc, see ordering information.

The input voltage range 36 to 75 Vdc meets the requirements of the European Telecom Standard ETS 300 132-2 for normal input voltage range in -48 and

-60 Vdc systems, -40.5 to -57.0 V and -50.0 to -72 V respectively.

At input voltages exceeding 75 V, the power loss will be higher than at normal input voltage and T_{p1} must be limited to absolute max +125°C. The absolute maximum continuous input voltage is 80 Vdc.

The input voltage range 40 to 60 Vdc meets the requirements for normal input voltage range in -48 V systems, -40.5 to -57.0 V. At input voltages exceeding 60 V, the power loss will be higher than at normal input voltage and T_{p1} must be limited to absolute max +125°C. The absolute maximum continuous input voltage is 65 Vdc.

Turn-off Input Voltage

The product monitors the input voltage and will turn on and turn off at predetermined levels. The minimum hysteresis between turn on and turn off input voltage is 2 V.

Remote Control (RC)

The products are fitted with a remote control function. The remote control is referenced to the primary negative input connection (-In). The RC function allows the converter to be turned on/off by an external device like a semiconductor or mechanical switch. The RC pin has an internal pull up resistor. The device should be capable of sinking 0.7 mA. When the RC pin is left open, the voltage

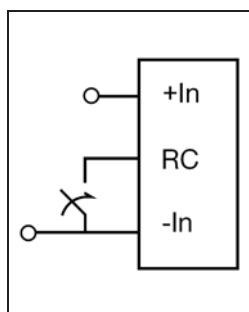

generated on the RC pin is max 6 V. The product is provided with "negative logic" remote control and will be off until the RC pin is connected to the -In. To turn on the product the voltage between RC pin and -In should be less than 1 V. To turn off the product the RC pin should be left open for a minimum of time 150 μ s, the same time requirement applies when the product shall turn on. In

situations where it is desired to have the product to power up automatically without the need for control signals or a switch, the RC pin can be wired directly to -In

Input and Output Impedance

The impedance of both the input source and the load will interact with the impedance of the product. It is important that the input source has low characteristic impedance. Minimum recommended external input capacitance is 100 μ F. The performance in some applications can be enhanced by addition of external capacitance as described under External Decoupling Capacitors.

External Decoupling Capacitors

When powering loads with significant dynamic current requirements, the voltage regulation at the point of load can be improved by addition of decoupling capacitors at the load. The most effective technique is to locate low ESR ceramic and electrolytic capacitors as close to the load as possible, using several parallel capacitors to lower the effective ESR. The ceramic capacitors will handle high-frequency dynamic load changes while the electrolytic

capacitors are used to handle low frequency dynamic load changes. Ceramic capacitors will also reduce any high frequency noise at the load. It is equally important to use low resistance and low inductance PWB layouts and cabling. External decoupling capacitors will become part of the product's control loop. The control loop is optimized for a wide range of external capacitance and the maximum recommended value that could be used without any additional analysis is found in the electrical specification. The ESR of the capacitors is a very important parameter. Stable operation is guaranteed with a verified ESR value of >10 m Ω across the output connections. For further information please contact your local CUI Power Modules representative.

Parallel Operation (Droop Load Share, DLS)

The NQB, DLS products are variants that can be connected in parallel. The products have a pre-configured voltage droop: The stated output voltage set point is at no load. The output voltage will decrease when the load current is increased. The voltage will droop 0.6 V while load reaches max load. This feature allows the products to be connected in parallel and share the current with 10% accuracy. Up to 90% of max output current can be used from each product.

Voltage regulation DLS products

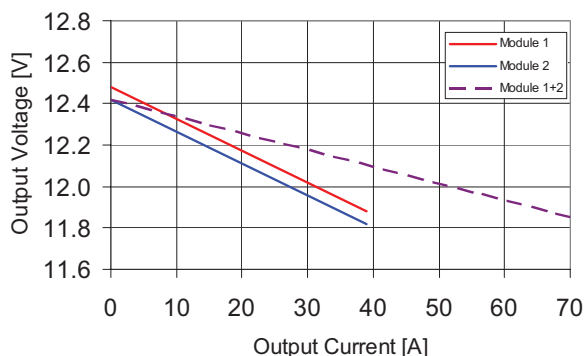

Feed Forward Capability

The NQB products have a feed forward function implemented that can handle sudden input voltage changes. The output voltage will be regulated during an input transient and will typically stay within 10% when an input transient is applied.

Soft-start Power Up

The rise time of the ramp up is 10 ms. When starting by applying input voltage the control circuit boot-up time adds an additional 15 ms delay. The DLS variants have a pre-configured ramp up time of 25 ms.

Temperature Protection (OTP, UTP)

The products are protected from thermal overload by an internal temperature shutdown protection. When T_{p1} as defined in thermal consideration section is exceeded the product will shut down. The product will make continuous attempts to start up and resume normal operation

automatically when the temperature has dropped below the temperature threshold; the hysteresis is defined in general electrical specification. The product has also an under temperature protection.

Over Voltage Protection (OVP)

The product includes over voltage limiting circuitry for protection of the load. The OVP limit is 30% above the nominal output voltage. The response from an over voltage fault is to immediately shut down. The device will continuously check for the presence of the fault condition, and when the fault condition no longer exists the device will be re-enabled.

Over Current Protection (OCP)

The product includes current limiting circuitry for protection at continuous overload. The setting for the product is hic-up mode if the maximum output current is exceeded and the output voltage is below $0.3 \times V_{out}$. Above the trip voltage the product will continue operate while maintaining the output current at the maximum output current. The load distribution should be designed for the maximum output short circuit current specified.

Droop Load Share variants (DLS) will enter hic-up mode, with a trip voltage, $0.04 \times V_{out}$. Above the trip voltage the product will continue to operate while maintaining the output current at the maximum output current

Input Over/Under voltage protection

The input of the product is protected from high input voltage and low input voltage.

Pre-bias Start-up Capability

The product has a Pre-bias start up functionality and will not sink current during start up if a Pre-bias source is present at the output terminals. If the Pre-bias voltage is lower than the target value, the product will ramp up to the target value. If the Pre-bias voltage is higher than the target value, the product will ramp down to the target value and in this case sink current for a limited time.

Output Voltage Regulation

The NQB products are designed to be fully regulated within the plotted area. Operating outside this area is not recommended.

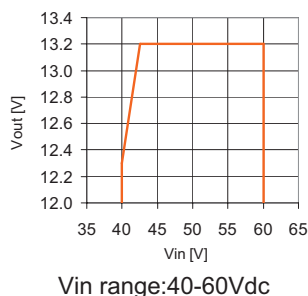
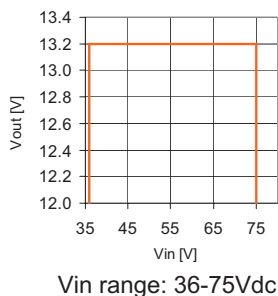

Thermal Consideration

General

The product is designed to operate in different thermal environments and sufficient cooling must be provided to ensure reliable operation. For products mounted on a PWB without a heat sink attached, cooling is achieved mainly by conduction, from the pins to the host board, and convection, which is dependant on the airflow across the product. Increased airflow enhances the cooling of the product. The Output Current Derating graph found in the output section for each model provides the available output current vs. ambient air temperature and air velocity at $V_1 = 53$ V.

The product is tested on a 254 x 254 mm, 35 μ m (1 oz), 16-layer test board mounted vertically in a wind tunnel with a cross-section of 608 x 203 mm.

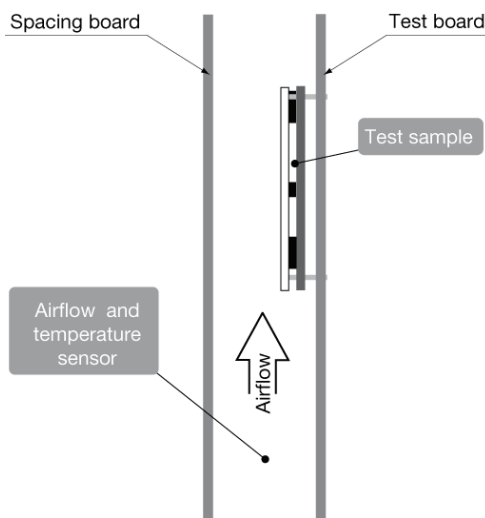

For products with base plate used in a sealed box/cold wall application, cooling is achieved mainly by conduction through the cold wall. The Output Current Derating graphs are found in the output section for each model. The product is tested in a sealed box test set up with ambient temperatures 85, 55 and 25°C.

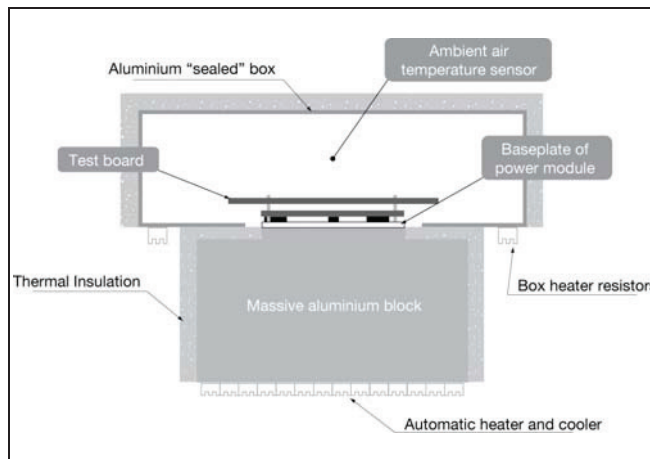

Definition of product operating temperature

The product operating temperature is used to monitor the temperature of the product, and proper thermal conditions can be verified by measuring the temperature at positions P1, P2, P3 and P4. The temperature at these positions (T_{P1} , T_{P2} , T_{P3} , T_{P4}) should not exceed the maximum temperatures in the table below. The number of measurement points may vary with different thermal design and topology. Temperatures above maximum T_{P1} , measured at the reference point P1 (T_{P3} / P_3 for base plate versions) are not allowed and may cause permanent damage.

Position	Description	Max temperature
P1	PWB (reference point, open frame)	$T_{P1}=125^{\circ}\text{C}$
P2	Opto-coupler	$T_{P2}=105^{\circ}\text{C}$
P3	PWB (reference point for base-plate version)	$T_{P3}=125^{\circ}\text{C}$
P4	Primary MOSFET	$T_{P4}=125^{\circ}\text{C}$

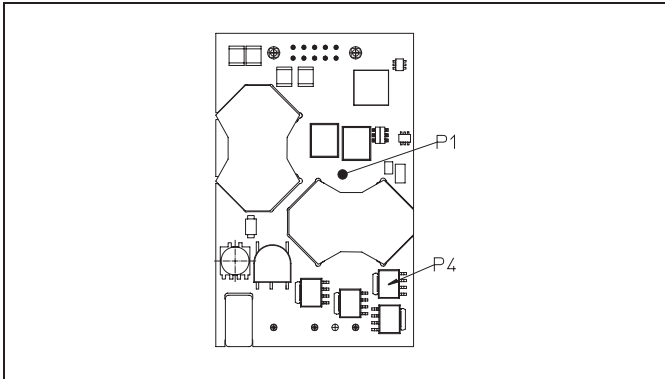

Top view

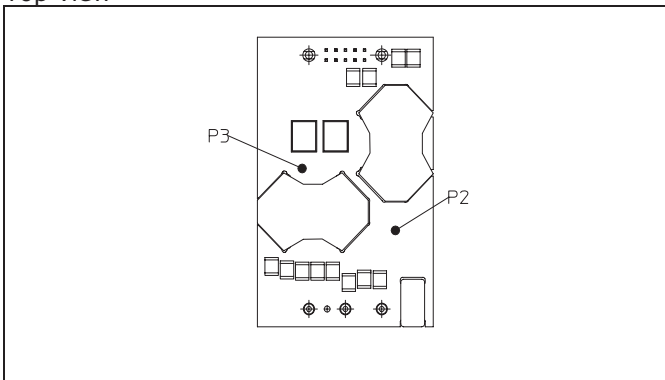

Bottom view

(Best air flow direction is from positive to negative pins.)

Ambient Temperature Calculation

For products with base plate the maximum allowed ambient temperature can be calculated by using the thermal resistance.

1. The power loss is calculated by using the formula $((1/\eta) - 1) \times \text{output power} = \text{power losses } (P_d)$.
 η = efficiency of product. E.g. 95 % = 0.95
2. Find the thermal resistance (R_{th}) in the Thermal

Resistance graph found in the Output section for each model. Note that the thermal resistance can be significantly reduced if a heat sink is mounted on the top of the base plate.

Calculate the temperature increase (ΔT).
 $\Delta T = R_{th} \times P_d$

3. Max allowed ambient temperature is:
 $\text{Max } T_{P1} - \Delta T$.

E.g. NQB-468 at 2m/s:

1. $((1/0.95) - 1) \times 468\text{ W} = 24.6\text{ W}$
2. $19.5\text{ W} \times 2.8^{\circ}\text{C/W} = 69.0^{\circ}\text{C}$
3. $125^{\circ}\text{C} - 69.0^{\circ}\text{C} = \text{max ambient temperature is } 56^{\circ}\text{C}$
 The actual temperature will be dependent on several factors such as the PWB size, number of layers and direction of airflow.

Connections (Top view)

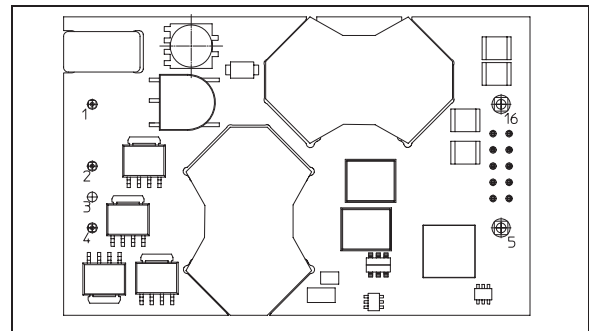

Pin	Designation	Function
1	+In	Positive Input
2	RC	Remote Control
3	Case	Case to GND (optional)
4	-In	Negative Input
5	-Out	Negative Output
16	+Out	Positive Output

Mechanical Information - Hole Mount, Open Frame Version

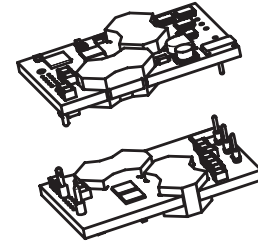
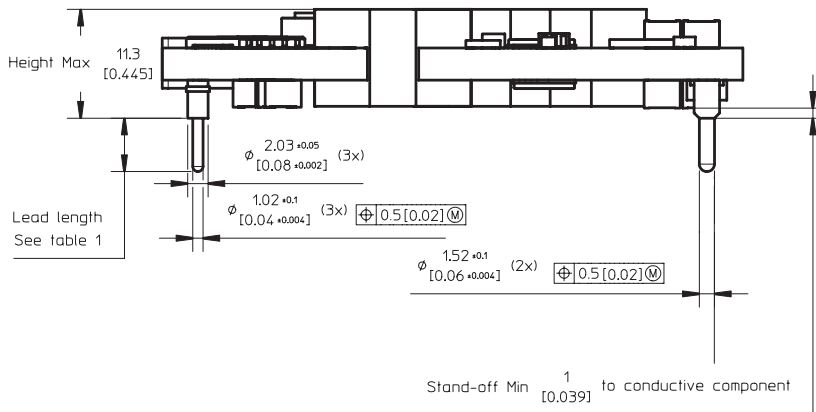

Top View
Pin Positions According To Recommended Footprint

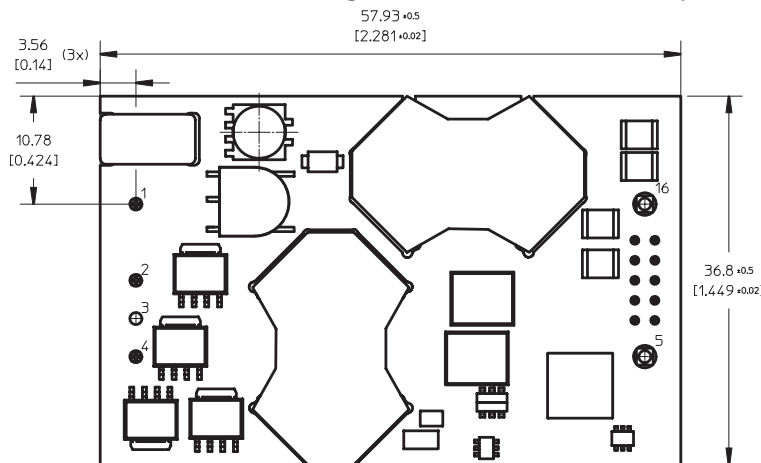

X1	Lead length
0	5.33 [0.210]
2	3.69 [0.145] (cut)
3	4.57 [0.180] (cut)
4	2.79 [0.110] (cut)

Table 1.
X1 = Ordering information

PIN SPECIFICATIONS
 Pin 1, 2, 4, 5 & 16 Material: Copper alloy
 Plating: Min Au 0.1 μ m over 1-3 μ m Ni.
 Pin position 3 is only used for base plate GND connection which is not available on this module.

Recommended Footprint - Top View

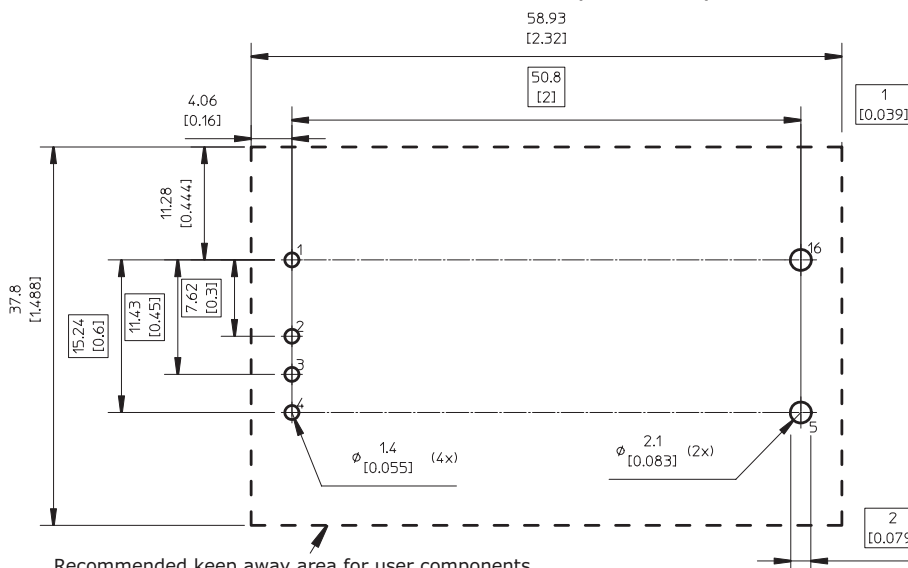

Recommended keep away area for user components.
 The stand-off in combination with insulating material ensures that requirements as per IEC/EN/UL60950 are met and 2250 V isolation maintained even if open vias or traces are present under the DC/DC converter.

Weight: Typical 48 g
 All dimensions: mm [inch]
 Tolerances:
 x.x \pm 0.50 [0.02]
 x.xx \pm 0.25 [0.01]
 (not applied on footprint or typical values)



Mechanical Information - Hole Mount, Base Plate Version

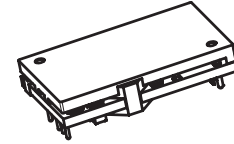
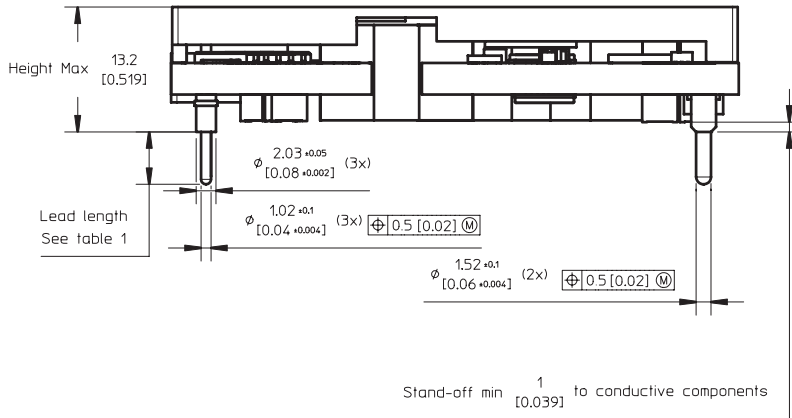

Top View
Pin Positions According To Recommended Footprint

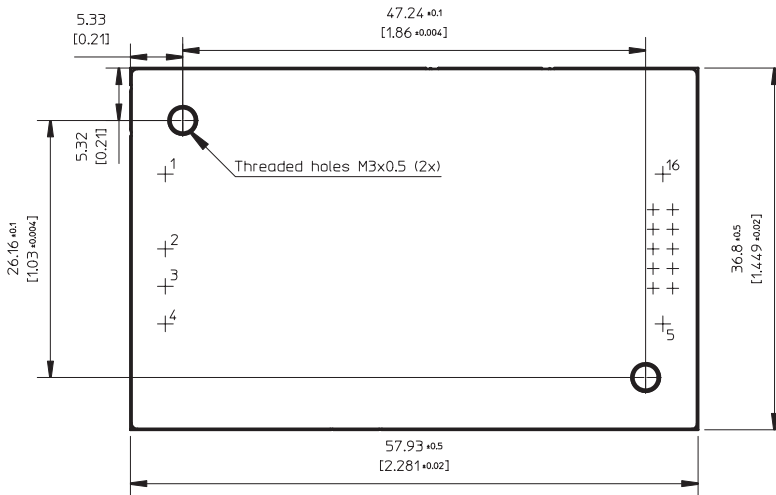

Recommended Footprint - Top View

X1	Lead length
0	5.33 [0.210]
2	3.69 [0.145] (cut)
3	4.57 [0.180] (cut)
4	2.79 [0.110] (cut)

Table 1.
X1 = Ordering information

CASE

Material: Aluminum
For screw attachment apply mounting torque of max 0.44 Nm [3.9 lbf in]. M3 screws must not protrude more than 2.7mm [0.106] into the base plate.

PIN SPECIFICATIONS

Pin 1, 2, 3, 4, 5 & 16 Material: Copper alloy
Plating: Min Au 0.1 μm over 1-3 μm Ni.

Pin position 3 is only used for base plate GND connection.

Weight: Typical 68 g
All dimensions: mm [inch]
Tolerances:
x.x \pm 0.50 [0.02]
x.xx \pm 0.25 [0.01]
(not applied on footprint or typical values)

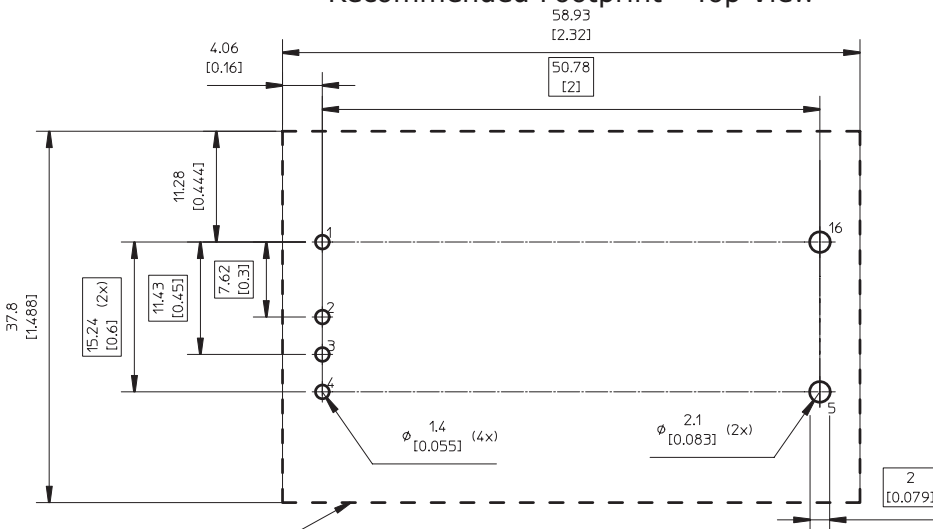

Recommended keep away area for user components.
The stand-off in combination with insulating material ensures that requirements as per IEC/EN/UL60950 are met and 2250 V isolation maintained even if open vias or traces are present under the DC/DC converter.

Mechanical Information - Surface Mount Version

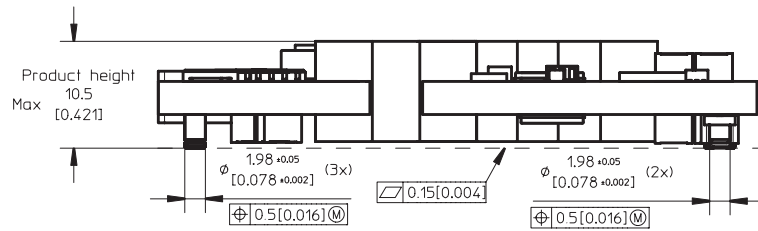
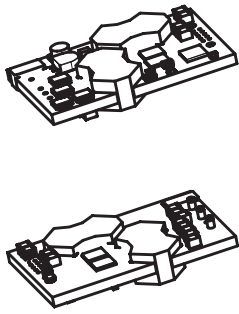

Top View
Pin Positions According To Recommended Footprint

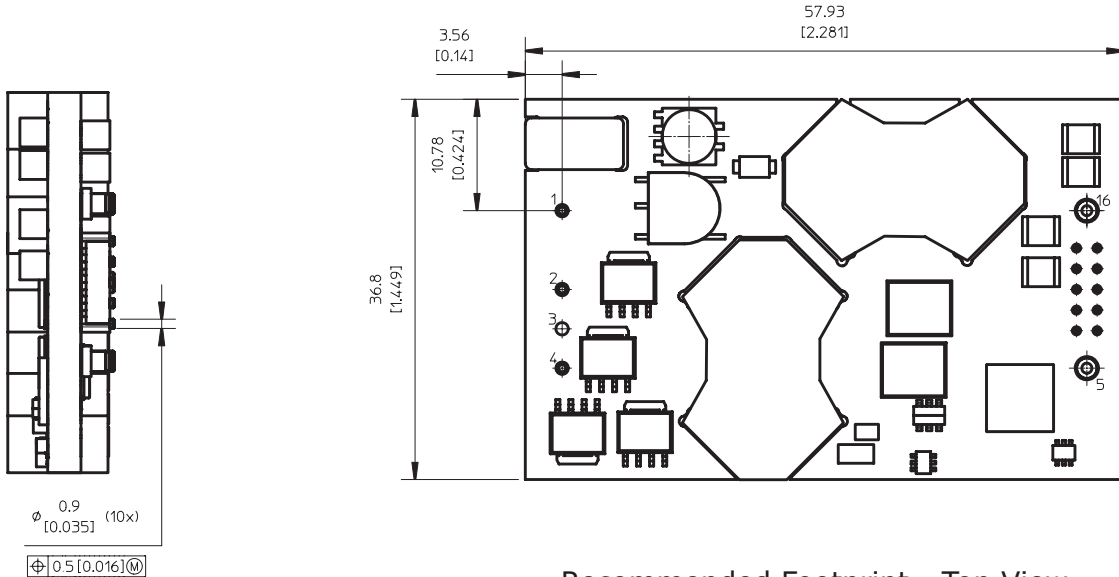

Recommended Footprint - Top View

PIN SPECIFICATIONS

Pin 1, 2, 4, 5 & 16 Material: Copper alloy
Plating: Min Au 0.1 µm over 1-3 µm Ni.

Weight: Typical 46 g
All dimensions: mm [inch]
Tolerances:
x.x ±0.50 [0.02]
x.xx ±0.25 [0.01]
(not applied on footprint or typical values)

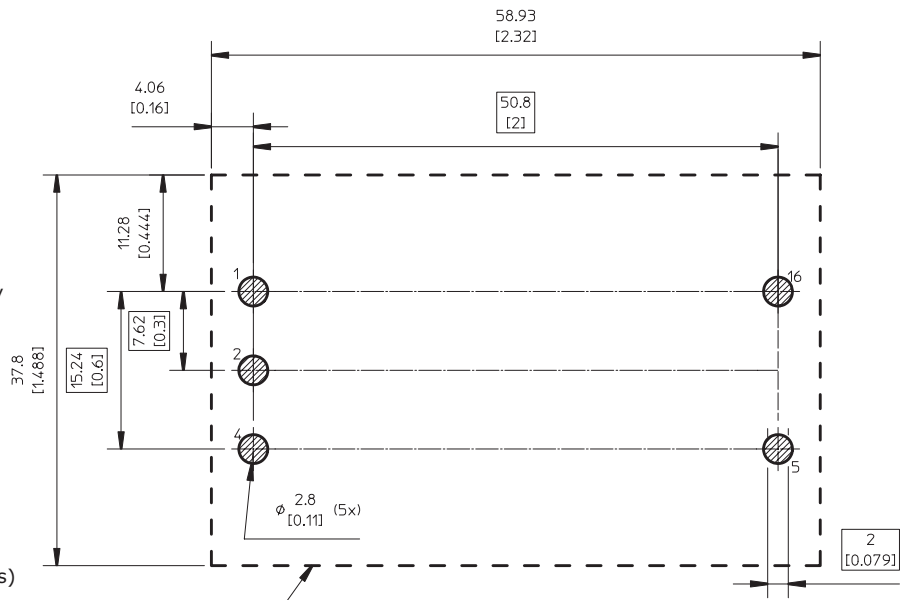

Recommended keep away area for user components.
The stand-off in combination with insulating material ensures that requirements as per IEC/EN/UL60950 are met and 2250 V isolation maintained even if open vias or traces are present under the DC/DC converter.



Soldering Information - Surface Mounting

The surface mount product is intended for forced convection or vapor phase reflow soldering in SnPb and Pb-free processes.

The reflow profile should be optimised to avoid excessive heating of the product. It is recommended to have a sufficiently extended preheat time to ensure an even temperature across the host PWB and it is also recommended to minimize the time in reflow.

A no-clean flux is recommended to avoid entrapment of cleaning fluids in cavities inside the product or between the product and the host board, since cleaning residues may affect long time reliability and isolation voltage.

General reflow process specifications		SnPb eutectic	Pb-free
Average ramp-up ($T_{PRODUCT}$)		3°C/s max	3°C/s max
Typical solder melting (liquidus) temperature	T_L	183°C	221°C
Minimum reflow time above T_L		60 s	60 s
Minimum pin temperature	T_{PIN}	210°C	235°C
Peak product temperature	$T_{PRODUCT}$	225°C	260°C
Average ramp-down ($T_{PRODUCT}$)		6°C/s max	6°C/s max
Maximum time 25°C to peak		6 minutes	8 minutes

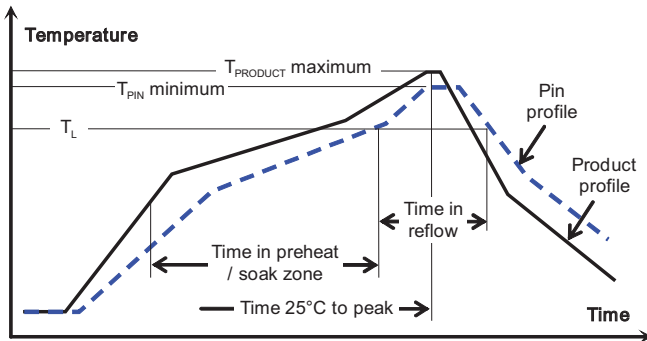

Minimum Pin Temperature Recommendations

Pin number 5 chosen as reference location for the minimum pin temperature recommendation since this will likely be the coolest solder joint during the reflow process.

SnPb solder processes

For SnPb solder processes, a pin temperature (T_{PIN}) in excess of the solder melting temperature, (T_L , 183°C for Sn63Pb37) for more than 60 seconds and a peak temperature of 220°C is recommended to ensure a reliable solder joint.

For dry packed products only: depending on the type of solder paste and flux system used on the host board, up to a recommended maximum temperature of 245°C could be used, if the products are kept in a controlled environment (dry pack handling and storage) prior to assembly.

Lead-free (Pb-free) solder processes

For Pb-free solder processes, a pin temperature (T_{PIN}) in excess of the solder melting temperature (T_L , 217 to 221°C for SnAgCu solder alloys) for more than 60 seconds and a peak temperature of 245°C on all solder joints is recommended to ensure a reliable solder joint.

Maximum Product Temperature Requirements

Top of the product PWB near pin 2 is chosen as reference location for the maximum (peak) allowed product temperature ($T_{PRODUCT}$) since this will likely be the warmest part of the product during the reflow process.

SnPb solder processes

For SnPb solder processes, the product is qualified for MSL 1 according to IPC/JEDEC standard J STD 020C.

During reflow $T_{PRODUCT}$ must not exceed 225 °C at any time.

Pb-free solder processes

For Pb-free solder processes, the product is qualified for MSL 3 according to IPC/JEDEC standard J-STD-020C.

During reflow $T_{PRODUCT}$ must not exceed 260 °C at any time.

Dry Pack Information

Products intended for Pb-free reflow soldering processes are delivered in standard moisture barrier bags according to IPC/JEDEC standard J STD 033 (Handling, packing, shipping and use of moisture/reflow sensitivity surface mount devices).

Using products in high temperature Pb-free soldering processes requires dry pack storage and handling. In case the products have been stored in an uncontrolled environment and no longer can be considered dry, the modules must be baked according to J STD 033.

Thermocoupler Attachment

Top of PWB near pin 2 for measurement of maximum product temperature, $T_{PRODUCT}$

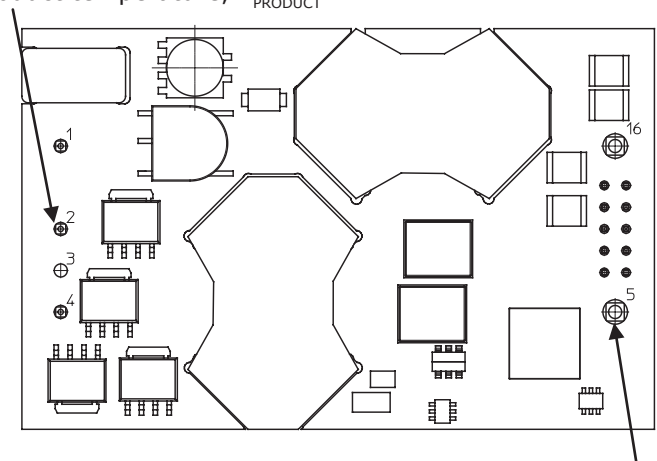

Pin 5 for measurement of minimum pin (solder joint) temperature, T_{PIN}

Soldering Information - Hole Mounting

The hole mounted product is intended for plated through hole mounting by wave or manual soldering. The pin temperature is specified to maximum to 270°C for maximum 10 seconds.

A maximum preheat rate of 4°C/s and maximum preheat temperature of 150°C is suggested. When soldering by hand, care should be taken to avoid direct contact between the hot soldering iron tip and the pins for more than a few seconds in order to prevent overheating.

A no-clean flux is recommended to avoid entrapment of cleaning fluids in cavities inside the product or between the product and the host board. The cleaning residues may affect long time reliability and isolation voltage.

Delivery Package Information

The products are delivered in antistatic injection molded trays (Jedec design guide 4.10D standard) and in antistatic trays.

Tray Specifications – SMD	
Material	Antistatic PPE
Surface resistance	$10^5 < \text{Ohm/square} < 10^{12}$
Bakability	The trays can be baked at maximum 125°C for 48 hours
Tray thickness	14.50 mm 0.571 [inch]
Box capacity	20 products (2 full trays/box)
Tray weight	125 g empty, 574 g full tray

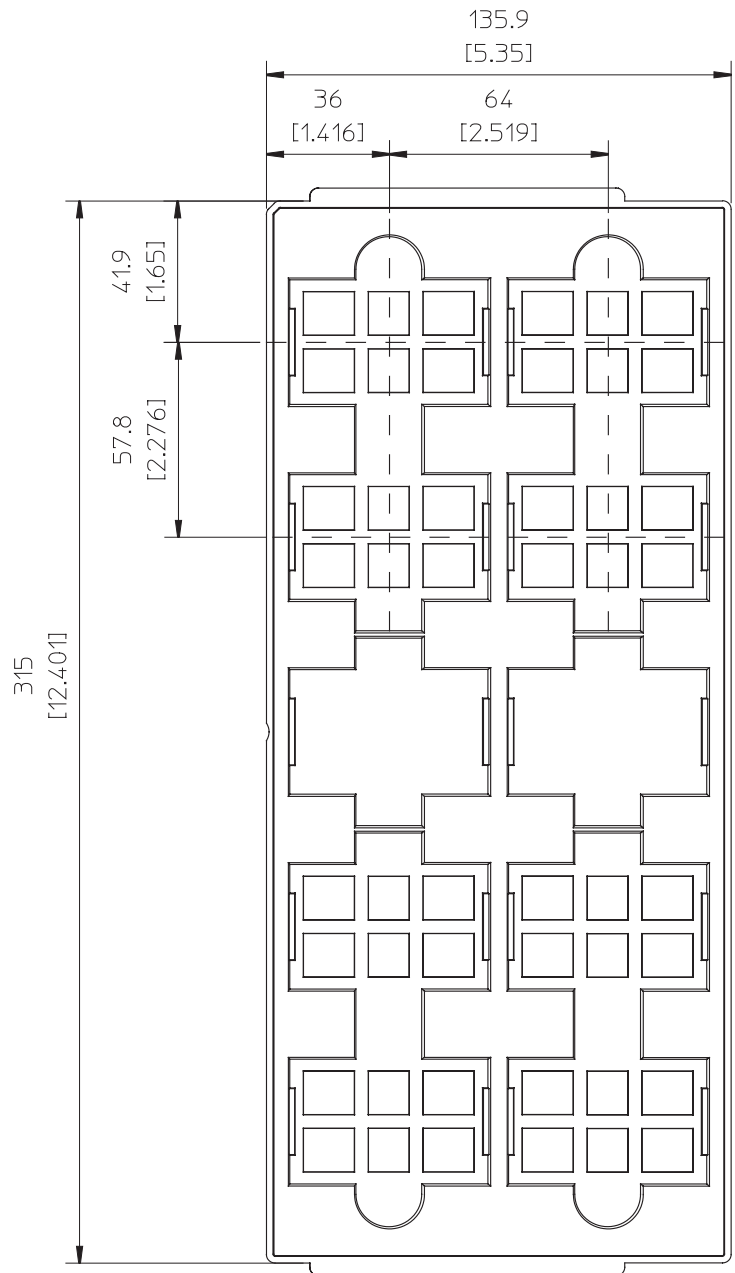

JEDEC standard tray for 2x5 = 10 products.

All dimensions in mm [inch]

Tolerances: X.x ±0.26 [0.01], X.xx ±0.13 [0.005]

Note: pick up positions refer to center of pocket.

See mechanical drawing for exact location on product.

Tray Specifications - TH	
Material	PE Foam
Surface resistance	$10^5 < \text{Ohm/square} < 10^{12}$
Bakability	The trays are not bakeable
Tray capacity	20 converters/tray
Box capacity	20 products (1 full tray/box)
Weight	Product – Open frame 1100 g full tray, 140g empty tray Product – Base plate option 1480 g full tray, 140 g empty tray

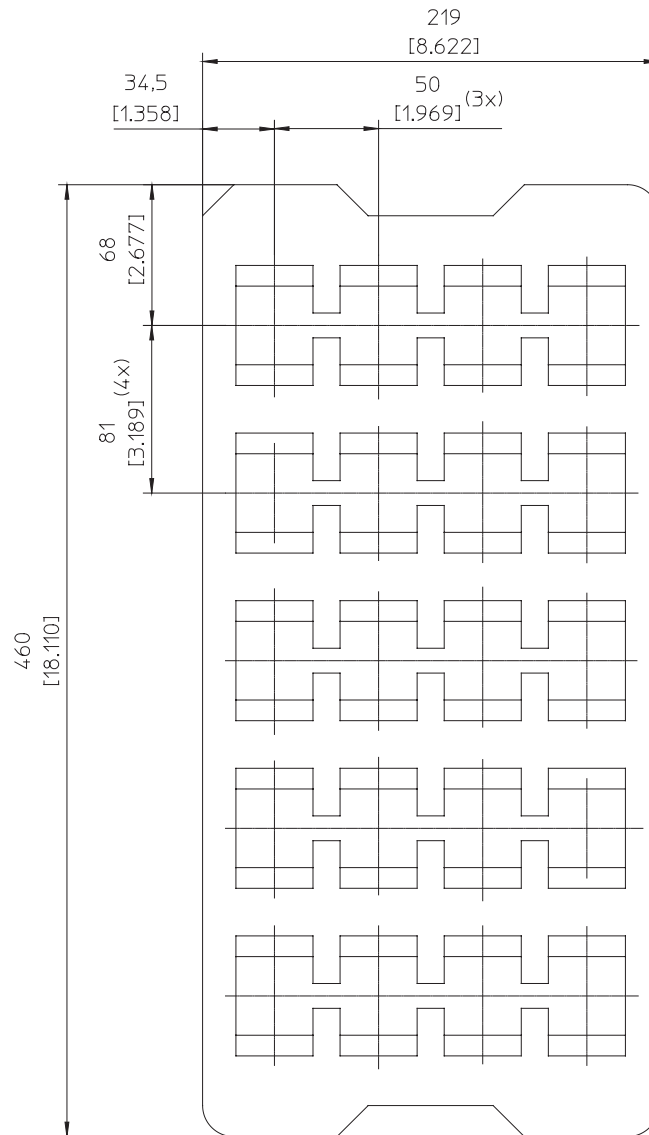

Product Qualification Specification

Characteristics			
External visual inspection	IPC-A-610		
Change of temperature (Temperature cycling)	IEC 60068-2-14 Na	Temperature range Number of cycles Dwell/transfer time	-40 to 100°C 500 15 min/0-1 min
Cold (in operation)	IEC 60068-2-1 Ad	Temperature T _A Duration	-45°C 72 h
Damp heat	IEC 60068-2-67 Cy	Temperature Humidity Duration	85°C 85 % RH 1000 hours
Dry heat	IEC 60068-2-2 Bd	Temperature Duration	125°C 1000 h
Electrostatic discharge susceptibility	IEC 61340-3-1, JESD 22-A114 IEC 61340-3-2, JESD 22-A115	Human body model (HBM) Machine Model (MM)	Class 2, 2000 V Class 3, 200 V
Immersion in cleaning solvents	IEC 60068-2-45 XA, method 2	Water Glycol ether Isopropyl alcohol	55°C 35°C 35°C
Mechanical shock	IEC 60068-2-27 Ea	Peak acceleration Duration	100 g 6 ms
Moisture reflow sensitivity ¹	J-STD-020C	Level 1 (SnPb-eutectic) Level 3 (Pb Free)	225°C 260°C
Operational life test	MIL-STD-202G, method 108A	Duration	1000 h
Resistance to soldering heat ²	IEC 60068-2-20 Tb, method 1A	Solder temperature Duration	270°C 10-13 s
Robustness of terminations	IEC 60068-2-21 Test Ua1 IEC 60068-2-21 Test Ue1	Through hole mount products Surface mount products	All leads All leads
Solderability	IEC 60068-2-58 test Td ¹	Preconditioning Temperature, SnPb Eutectic Temperature, Pb-free	150°C dry bake 16 h 215°C 235°C
	IEC 60068-2-20 test Ta ²	Preconditioning Temperature, SnPb Eutectic Temperature, Pb-free	Steam ageing 235°C 245°C
Vibration, broad band random	IEC 60068-2-64 Fh, method 1	Frequency Spectral density Duration	10 to 500 Hz 0.07 g ² /Hz 10 min in each direction

Notes: 1. Only for products intended for reflow soldering (surface mount products)
2. Only for products intended for wave soldering (plated through hole products)

REVISION HISTORY

rev.	date
1.01	11/07/2014

The revision history provided is for informational purposes only and is believed to be accurate.



Headquarters
20050 SW 112th Ave.
Tualatin, OR 97062
800.275.4899

Fax 503.612.2383
cui.com
techsupport@cui.com

Novum and Architects of Modern Power are trademarks of CUI.
All other trademarks are the property of their respective owners.

CUI offers a two (2) year limited warranty. Complete warranty information is listed on our website.

CUI reserves the right to make changes to the product at any time without notice. Information provided by CUI is believed to be accurate and reliable. However, no responsibility is assumed by CUI for its use, nor for any infringements of patents or other rights of third parties which may result from its use.

CUI products are not authorized or warranted for use as critical components in equipment that requires an extremely high level of reliability. A critical component is any component of a life support device or system whose failure to perform can be reasonably expected to cause the failure of the life support device or system, or to affect its safety or effectiveness.