

## Gallium Nitride 28V, 100W RF Power Transistor

Built using the SIGANTIC® NRF1 process - A proprietary GaN-on-Silicon technology

### FEATURES

- Optimized for broadband operation from DC – 2000MHz
- 100W  $P_{3dB}$  CW power at 900MHz
- 60-95 W  $P_{SAT}$  CW power from 500-1000MHz in broadband application design
- High efficiency from 14 - 28V
- 1.4 °C/W  $R_{TH}$  with maximum  $T_J$  rating of 200°C
- Robust up to 10:1 VSWR mismatch at all phase angles with no damage to the device
- Subject to EAR99 export control

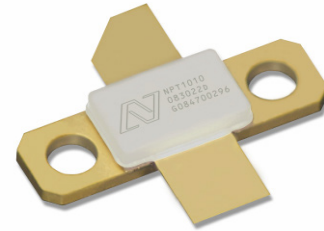

**DC – 2000 MHz**  
**14 – 28 Volt**  
**GaN HEMT**



**RF Specifications (CW, 900MHz):**  $V_{DS} = 28V$ ,  $I_{DQ} = 700mA$ ,  $T_A = 25^\circ C$ , Measured in Nitronex Test Fixture

Symbol	Parameter	Min	Typ	Max	Units
$P_{3dB}$	Average Output Power at 3dB Gain Compression	49.0	50.0	-	dBm
$P_{1dB}$	Average Output Power at 1dB Gain Compression	-	49.0	-	dBm
$G_{SS}$	Small Signal Gain	18.7	19.7	-	dB
$\eta$	Drain Efficiency at 3dB Gain Compression	57	64	-	%
VSWR	10:1 VSWR at all phase angles	No damage to the device			

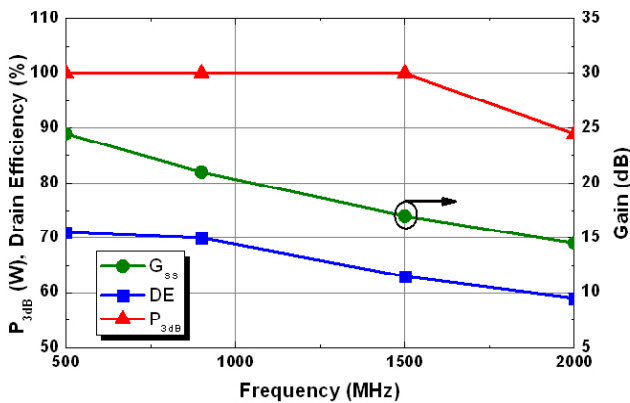

**Figure 1 - Typical CW Performance in Load-Pull,**  
 $V_{DS} = 28V$ ,  $I_{DQ} = 700mA$

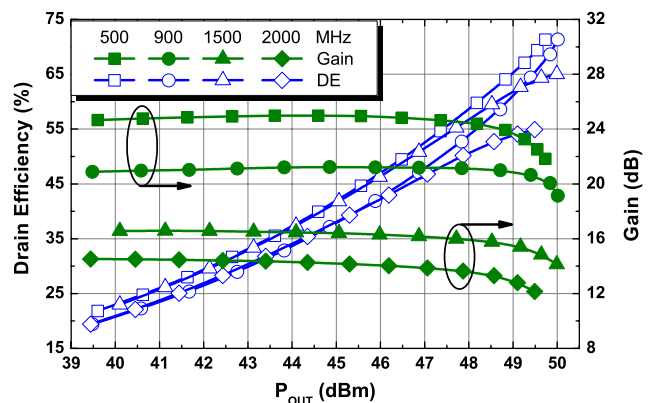

**Figure 2 - Typical CW Performance in Load-Pull,**  
 $V_{DS} = 28V$ ,  $I_{DQ} = 700mA$

## DC Specifications: $T_A = 25^\circ\text{C}$

Symbol	Parameter	Min	Typ	Max	Units
<b>Off Characteristics</b>					
$V_{BDS}$	Drain-Source Breakdown Voltage ( $V_{GS} = -8\text{V}$ , $I_D = 36\text{mA}$ )	100	-	-	V
$I_{DLK}$	Drain-Source Leakage Current ( $V_{GS} = -8\text{V}$ , $V_{DS} = 60\text{V}$ )	-	9	18	mA
<b>On Characteristics</b>					
$V_T$	Gate Threshold Voltage ( $V_{DS} = 28\text{V}$ , $I_D = 36\text{mA}$ )	-2.3	-1.8	-1.3	V
$V_{GSQ}$	Gate Quiescent Voltage ( $V_{DS} = 28\text{V}$ , $I_D = 700\text{mA}$ )	-2.0	-1.5	-1.0	V
$R_{ON}$	On Resistance ( $V_{GS} = 2\text{V}$ , $I_D = 270\text{mA}$ )	-	0.13	0.14	$\Omega$
$I_{D,MAX}$	Drain Current ( $V_{DS} = 7\text{V}$ pulsed, 300 $\mu\text{s}$ pulse width, 0.2% duty cycle)	19.0	21.0	-	A

## Thermal Resistance Specification

Symbol	Parameter	Min	Typ	Max	Units
$\theta_{JC}$	Thermal Resistance (Junction-to-Case), $T_J = 180^\circ\text{C}$	-	1.4	-	$^\circ\text{C}/\text{W}$

## Absolute Maximum Ratings: Not simultaneous, $T_C = 25^\circ\text{C}$ unless otherwise noted

Symbol	Parameter	Max	Units
$V_{DS}$	Drain-Source Voltage	100	V
$V_{GS}$	Gate-Source Voltage	-10 to 3	V
$I_G$	Gate Current	180	mA
$P_T$	Total Device Power Dissipation (Derated above $25^\circ\text{C}$ )	125	W
$T_{STG}$	Storage Temperature Range	-65 to 150	$^\circ\text{C}$
$T_J$	Operating Junction Temperature	200	$^\circ\text{C}$
HBM	Human Body Model ESD Rating (per JESD22-A114)	1B (>500V)	
MM	Machine Model ESD Rating (per JESD22-A115)	Class A ( $\leq 200\text{V}$ )	
CDM	Charge Device Model ESD Rating (per JESD22-C101)	IV (>1000V)	

## Load-Pull Data, Reference Plane at Device Leads

$V_{DS}=28V$ ,  $I_{DQ}=700mA$ ,  $T_A=25^\circ C$  unless otherwise noted

**Table 1:** Optimum Source and Load Impedances for CW Gain, Drain Efficiency, and Output Power Performance

Frequency (MHz)	$Z_S (\Omega)$	$Z_L (\Omega)$	$P_{SAT} (W)$	$G_{SS} (dB)$	Drain Efficiency @ $P_{SAT}$ (%)
500	$2.8 + j2.2$	$2.7 + j2.0$	100	24.5	71%
900	$1.1 - j0.5$	$1.9 + j0.6$	100	21.0	70%
1500	$1.1 - j3.6$	$2.0 - j1.2$	100	17.0	63%
2000	$1.1 - j4.9$	$1.9 - j3.8$	89	14.5	59%

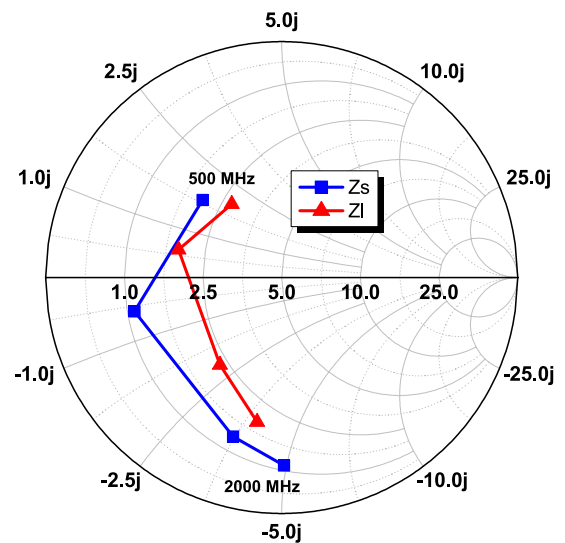
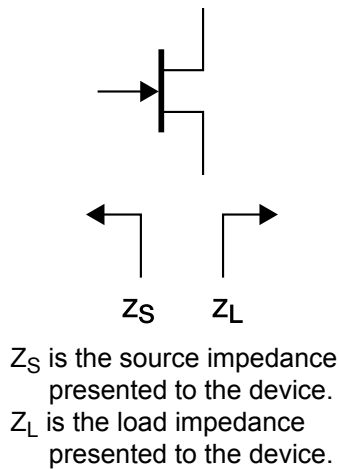

**Figure 3 - Optimum Impedances for CW Performance.  $Z_0 = 5 \Omega$**

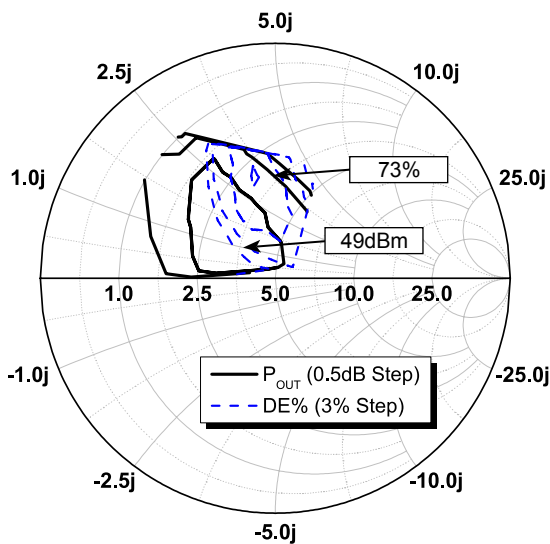

**Figure 4 - Load-Pull Contours, 500MHz,  $P_{IN} = 27dBm$ ,  $Z_S = 2.8 + j2.2 \Omega$**

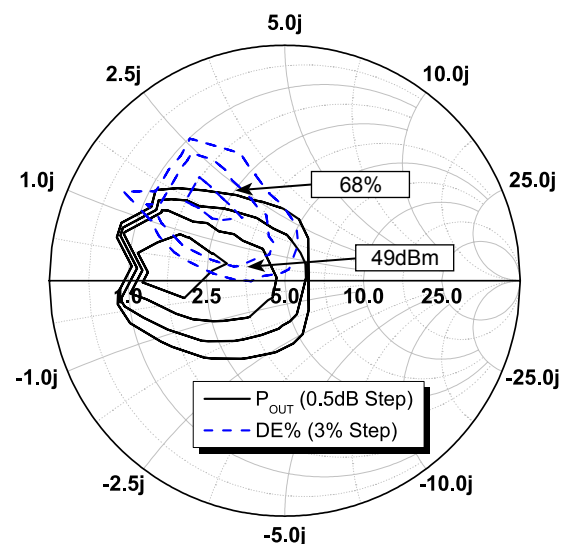

**Figure 5 - Load-Pull Contours, 900MHz,  $P_{IN} = 32.5dBm$ ,  $Z_S = 1.1 - j0.5 \Omega$**

## Load-Pull Data, Reference Plane at Device Leads

$V_{DS}=28V, I_{DQ}=700mA, T_A=25^\circ C$  unless otherwise noted.

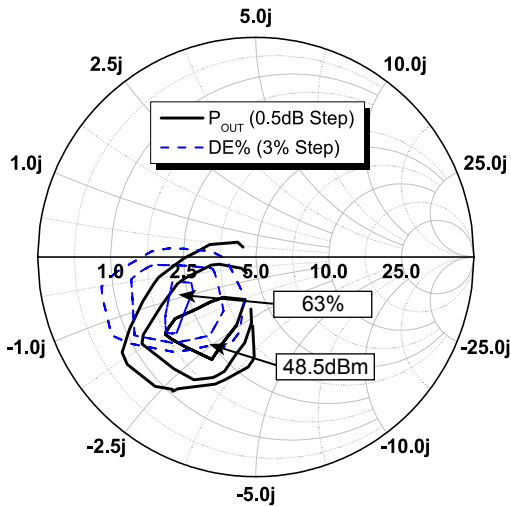

**Figure 6** - Load-Pull Contours, 1500MHz,  $P_{IN} = 29dBm, Z_S = 1.1 - j3.6 \Omega$

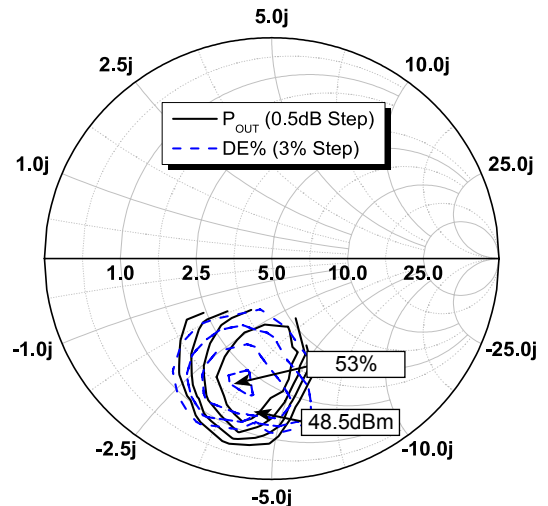

**Figure 7** - Load-Pull Contours, 2000MHz,  $P_{IN} = 36dBm, Z_S = 1.1 - j4.9 \Omega$

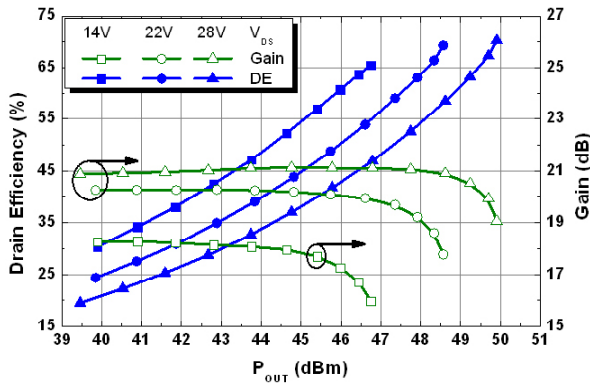

**Figure 8** - Typical CW Performance Over Voltage in Load-Pull, 900MHz

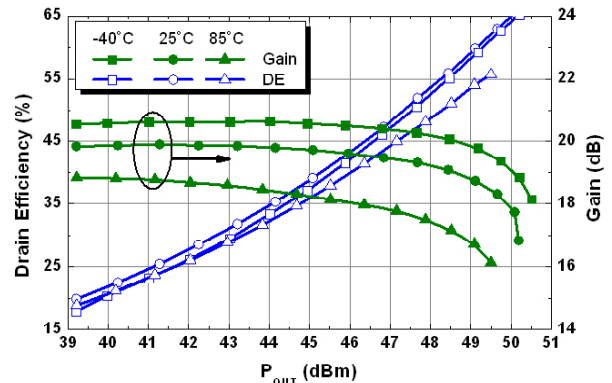

**Figure 9** - Typical CW Performance Over Temperature in Nitronex Test Fixture, 900MHz

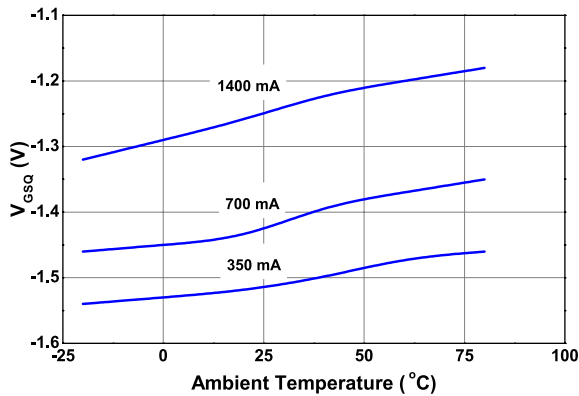

**Figure 10** - Quiescent Gate Voltage ( $V_{GSQ}$ ) Required to Reach  $I_{DQ}$  as a Function of Ambient Temperature,  $V_{DS} = 28V$

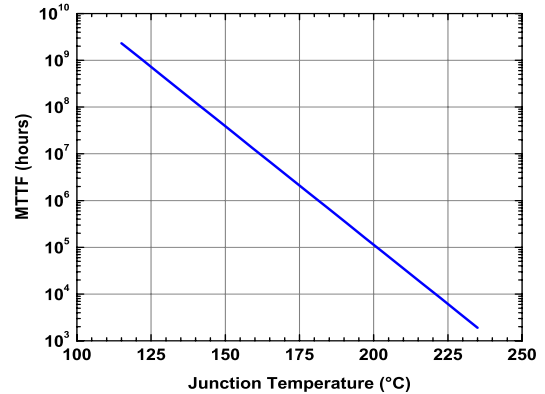

**Figure 11** - MTTF of NRF1 Devices as a Function of Junction Temperature

## RF Performance in 500-1000MHz Broadband Application Circuit

$V_{DS}=28V$ ,  $I_{DQ}=700mA$ ,  $T_A=25^\circ C$  unless otherwise noted

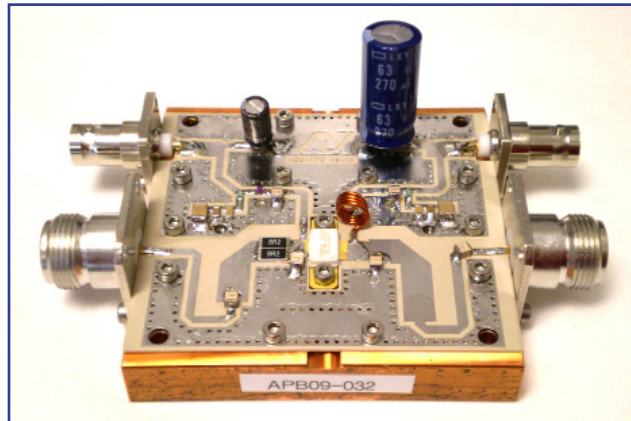

**Figure 12** - Photograph of 500-1000MHz broadband application circuit for NPT1010

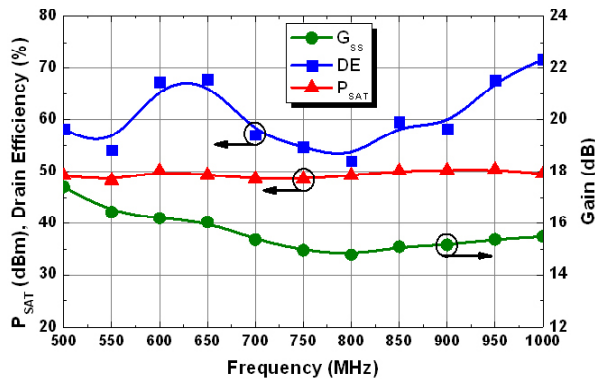

**Figure 13** - CW Performance in broadband circuit. Measurements (symbols) are connected by a smoothing function (25 °C)

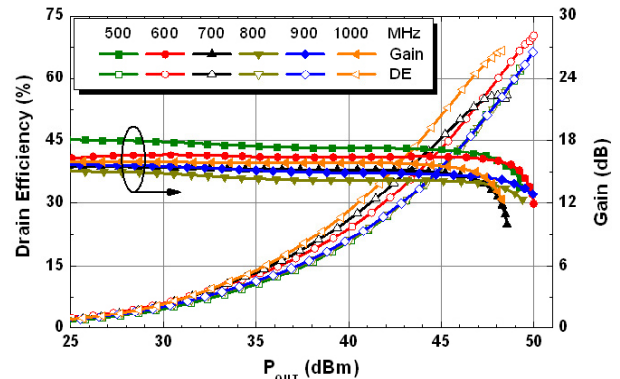

**Figure 14** - CW drive up curves in broadband circuit.

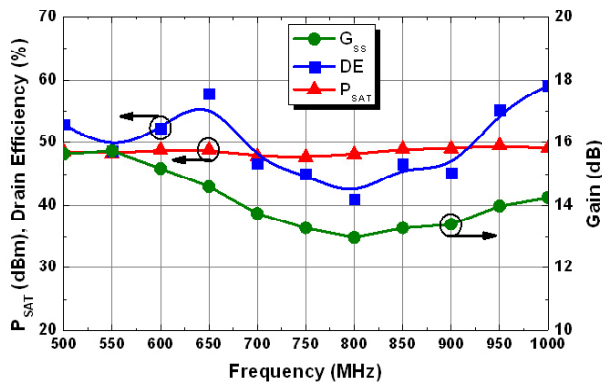

**Figure 15** - CW Performance in broadband circuit. Measurements (symbols) are connected by a smoothing function (100 °C)

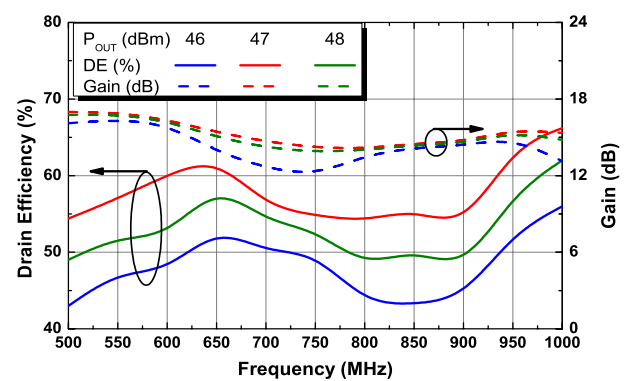

**Figure 16** - CW Performance in broadband circuit at different output powers connected by a smoothing function

## RF Performance in 500-1000MHz Broadband Application Circuit

$V_{DS}=28V$ ,  $I_{DQ}=700mA$ ,  $T_A=25^\circ C$  unless otherwise noted

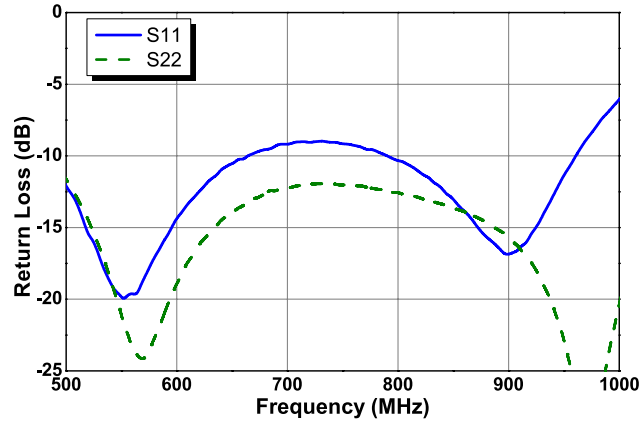
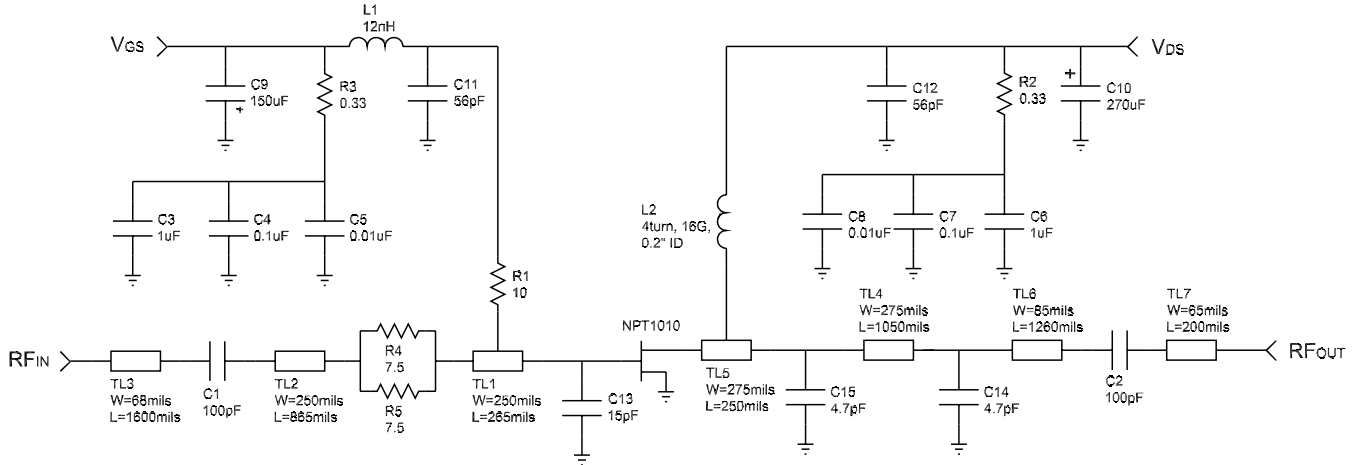

**Figure 17** - Input and output return loss of the 500-1000MHz broadband application circuit,  $P_{IN} = -5dBm$

**Table 2:** Power, gain, efficiency and temperature rise across frequency in the 500-1000MHz application circuit

Frequency (MHz)	$P_{SAT}$ (dBm)	$P_{SAT}$ (W)	Drain Efficiency @ $P_{SAT}$ (%)	$G_{SS}$ (dB)	$T_{J,RISE}$ ( $^\circ C$ ) <sup>1</sup>
500	48.9	77.8	60	18.1	76
550	49.3	84.9	65	17.4	66
600	49.8	94.8	69	16.6	63
650	48.3	68.2	63	16.1	59
700	48.1	63.8	56	15.5	73
750	48.0	63.1	55	15.1	76
800	49.4	86.9	63	15.1	76
850	49.7	92.5	66	15.4	71
900	50.0	98.9	66	15.7	74
950	49.0	79.4	69	16.0	53
1000	48.3	67.1	67	16.0	49

Note 1: Temperature rise is from junction to case and is calculated from the dissipated power using an  $R_{TH}$  value of  $1.4^\circ C/W$



**Figure 18 - Schematic of 500-1000MHz application board for NPT1010**

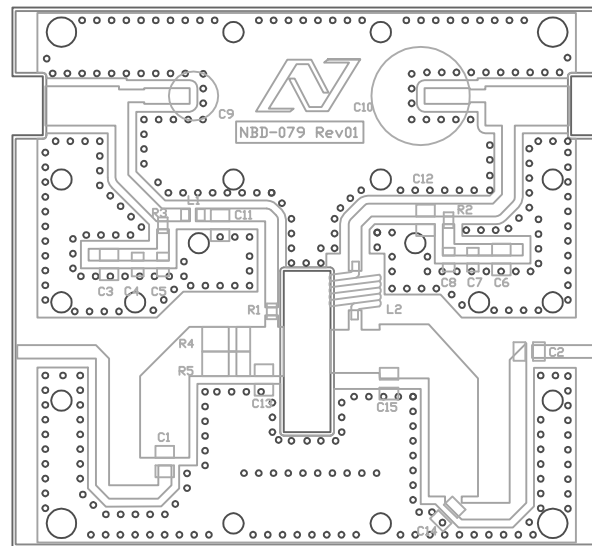

**Figure 19 - Layout of 500-1000MHz application board for NPT1010**

**Table 3:** NPT1010 500-1000MHz Application Board Build of Materials

Name	Value	Tolerance	Size	Vendor	Vendor Number
C1	100pF	5%	.11"X.11"	ATC	ATC100B101J
C2	100pF	5%	.11"X.11"	ATC	ATC100B101J
C3, C6	1.0uF	10%	1812	AVX Corp	18121C105KAT2A
C4, C7	0.1uF	10%	1206	Kemet	C1206C104K1RACTU
C5, C8	0.01uF	1%	1206	AVX Corp	12061C103KAT2A
C9	150uF	20%	3216(EIA)	Nichicon	UPW1C151MED
C10	270uF	20%	10mm(dia)	United Chmi-Con	ELXY 630ELL271MK25S
C11, C12	56pF	1%	.11"X.11"	ATC	ATC100B560J
C14, C15	4.7pF	1%	.11"X.11"	ATC	ATC100B4R7J
C13	15pF	1%	.11"X.11"	ATC	ATC100B150J
R1	10 ohms	5%	805	Panasonic	ERJ-6ENF10R0V
R2, R3	0.33 ohms	1%	805	Panasonic	ERJ-6RQFR33V
R4, R5	7.5 ohms	1%	2512	Stackpole Electron-	RHC 2512 10 1% R
L1	12nH	5%	805	Coilcraft	0805CS-120XJB
L2	4 Turn, 16G, 0.2"ID Copper Wire				
N Connector				Amphenol	172195
nbd-079_Rev1				Rogers	Rogers 6010LM 25mil, 1oz, $\epsilon_r = 10.2$
Copper Heatsink					
BNC Connectors				Tyco Electronics	1052566-1
Metric 18-8 SS Socket head Cap Screw M2.5 Thread, 8mm Length, 0.45mm Pitch				McMaster Carr	91292A012



## Ordering Information<sup>1</sup>

Part Number	Description
NPT1010B	NPT1010 in AC360B-2 Metal-Ceramic Bolt-Down Package

1: To find a Nitronex contact in your area, visit our website at <http://www.nitronex.com>

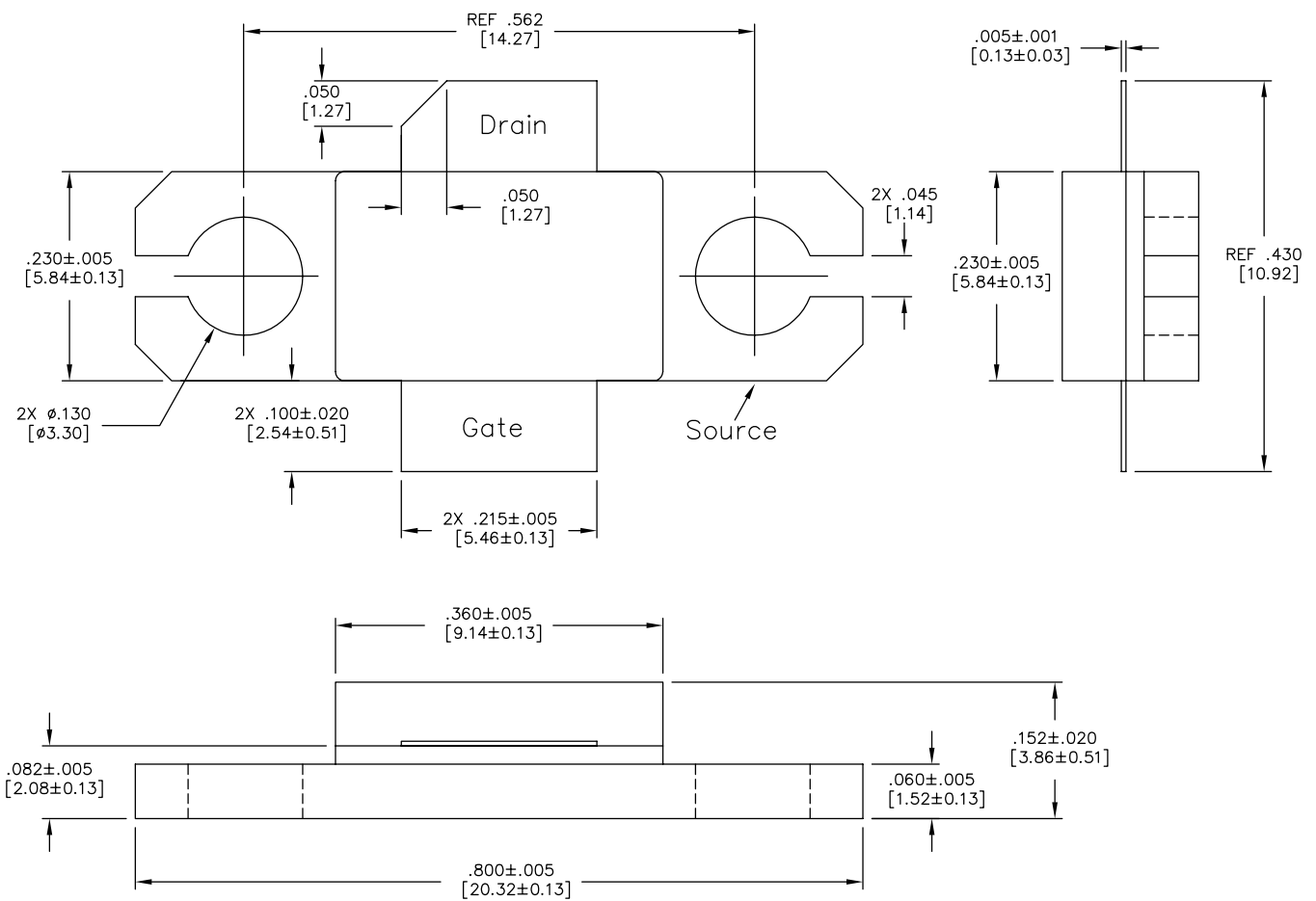

**Figure 20 - AC360B-2 Metal-Ceramic Package Dimensions and Pinout (all dimensions are in inches [mm])**

## Nitronex, LLC

2305 Presidential Drive  
Durham, NC 27703 USA  
+1.919.807.9100 (telephone)  
+1.919.807.9200 (fax)  
info@nitronex.com  
www.nitronex.com

## Additional Information

**This part is lead-free and is compliant with the RoHS directive (Restrictions on the Use of Certain Hazardous Substances in Electrical and Electronic Equipment).**

## Important Notice

Nitronex, LLC reserves the right to make corrections, modifications, enhancements, improvements and other changes to its products and services at any time and to discontinue any product or service without notice. Customers should obtain the latest relevant information before placing orders and should verify that such information is current and complete. All products are sold subject to Nitronex terms and conditions of sale supplied at the time of order acknowledgment. The latest information from Nitronex can be found either by calling Nitronex at 1-919-807-9100 or visiting our website at [www.nitronex.com](http://www.nitronex.com).

Nitronex warrants performance of its packaged semiconductor or die to the specifications applicable at the time of sale in accordance with Nitronex standard warranty. Testing and other quality control techniques are used to the extent Nitronex deems necessary to support the warranty. Except where mandated by government requirements, testing of all parameters of each product is not necessarily performed.

Nitronex assumes no liability for applications assistance or customer product design. Customers are responsible for their product and applications using Nitronex semiconductor products or services. To minimize the risks associated with customer products and applications, customers should provide adequate design and operating safeguards.

Nitronex does not warrant or represent that any license, either express or implied, is granted under any Nitronex patent right, copyright, mask work right, or other Nitronex intellectual property right relating to any combination, machine or process in which Nitronex products or services are used.

Reproduction of information in Nitronex data sheets is permitted if and only if said reproduction does not alter any of the information and is accompanied by all associated warranties, conditions, limitations and notices. Any alteration of the contained information invalidates all warranties and Nitronex is not responsible or liable for any such statements.

Nitronex products are not intended or authorized for use in life support systems, including but not limited to surgical implants into the body or any other application intended to support or sustain life. Should Buyer purchase or use Nitronex, LLC products for any such unintended or unauthorized application, Buyer shall indemnify and hold Nitronex, LLC, its officers, employees, subsidiaries, affiliates, distributors, and its successors harmless against all claims, costs, damages, and expenses, and reasonable attorney fees arising out of, directly or indirectly, any claim of personal injury or death associated with such unintended or unauthorized use, notwithstanding if such claim alleges that Nitronex was negligent regarding the design or manufacture of said products.

Nitronex and the Nitronex logo are registered trademarks of Nitronex, LLC.  
All other product or service names are the property of their respective owners.  
©Nitronex, LLC 2012. All rights reserved.