

## Features

- GaN on Si HEMT D-Mode Amplifier
- Suitable for linear and saturated applications
- Broadband operation from 20 - 1000 MHz
- 50  $\Omega$  Input Matched, Output Unmatched
- 28 V Operation
- 14 dB Gain @ 900 MHz
- 65% Drain Efficiency @ 900 MHz
- 100% RF Tested
- Lead-Free 6 x 5 mm 8-lead PDFN Package
- Halogen-Free “Green” Mold Compound
- RoHS\* Compliant



## Description

The NPA1006 is a wideband GaN power amplifier optimized for 20 - 1000 MHz operation. This amplifier has been designed for saturated and linear operation with output levels to 12.5 W (41 dBm) assembled in a lead-free 6 x 5 mm 8-lead PDFN plastic package.

The NPA1006 is ideally suited for general purpose narrowband to broadband applications in test and measurement, defense communications, land mobile radio and wireless infrastructure.

## Functional Schematic

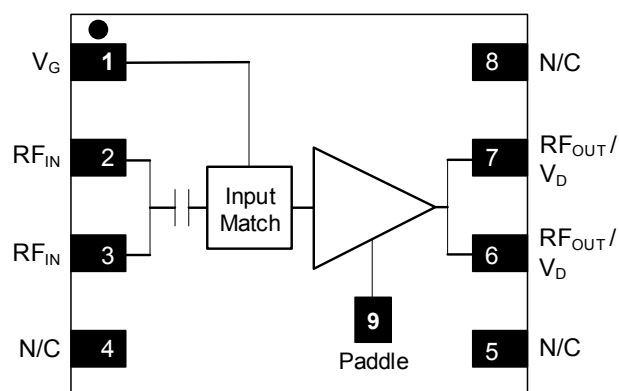

## Pin Designations

Pin No.	Pin Name	Function
1	$V_G$	Gate Voltage
2	$RF_{IN}$	RF Input
3	$RF_{IN}$	RF Input
4	N/C <sup>1</sup>	No Connection
5	N/C <sup>1</sup>	No Connection
6	$RF_{OUT} / V_D$	RF Output / Drain Voltage
7	$RF_{OUT} / V_D$	RF Output / Drain Voltage
8	N/C <sup>1</sup>	No Connection
9	Paddle <sup>2</sup>	Ground

1. All no connection pins may be left floating or grounded.
2. The exposed pad centered on the package bottom must be connected to RF and DC ground. This path must also provide a low thermal resistance heat path.

## Ordering Information

Part Number	Package
NPA1006	Bulk Quantity
NPA1006-SMB	Sample Board

\* Restrictions on Hazardous Substances, European Union Directive 2011/65/EU.

## GaN Wideband Power Amplifier, 28 V, 12.5 W 20 - 1000 MHz

Rev. V2

### RF Electrical Specifications:

$T_C = 25^\circ\text{C}$  ,  $V_{DS} = 28\text{ V}$  ,  $I_{DQ} = 88\text{ mA}$  , 100 - 1000 MHz Broadband Characterization Circuit

Parameter	Test Conditions	Symbol	Min.	Typ.	Max.	Units
Small Signal Gain	CW, 900 MHz	$G_{SS}$	-	15.0	-	dB
Gain	CW, $P_{OUT} = 41\text{ dBm}$ , 900 MHz	$G_P$	12.5	14.0	-	dB
Saturated Output Power	CW, 900 MHz	$P_{SAT}$	-	42.9	-	dBm
Drain Efficiency	CW, $P_{OUT} = 41\text{ dBm}$ , 900 MHz	$\eta_D$	61	65	-	%
Power Added Efficiency	CW, $P_{OUT} = 41\text{ dBm}$ , 900 MHz	PAE	57.5	62.4	-	%
Drain Efficiency	CW, 900 MHz	$\eta_{DSAT}$	-	70	-	%
Drain Voltage ( $V_{DS}$ )	Drain Voltage	$V_{DS}$	-	28	-	V
Ruggedness	All phase angles	$\Psi$	VSWR = 15:1, No Device Damage			

### DC Electrical Specifications: $T_C = 25^\circ\text{C}$

Parameter	Test Conditions	Symbol	Min.	Typ.	Max.	Units
Drain-Source Leakage Current	$V_{GS} = -8\text{ V}$ , $V_{DS} = 100\text{ V}$	$I_{DLK}$	-	6	-	mA
Gate-Source Leakage Current	$V_{GS} = -8\text{ V}$ , $V_{DS} = 0\text{ V}$	$I_{GLK}$	-	3	-	mA
Gate Threshold Voltage	$V_{DS} = 28\text{ V}$ , $I_D = 6\text{ mA}$	$V_T$	-2.5	-1.5	-0.5	V
Gate Quiescent Voltage	$V_{DS} = 28\text{ V}$ , $I_D = 88\text{ mA}$	$V_{GSQ}$	-2.1	-1.2	-0.3	V
On Resistance	$V_{DS} = 2\text{ V}$ , $I_D = 45\text{ mA}$	$R_{ON}$	-	0.8	-	$\Omega$
Saturated Drain Current	$V_{DS} = 7\text{ V}$ pulsed, pulse width 300 $\mu\text{s}$	$I_{D(SAT)}$	-	3.5	-	A

## Absolute Maximum Ratings<sup>3,4,5</sup>

Parameter	Absolute Maximum
Drain Source Voltage, $V_{DS}$	100 V
Gate Source Voltage, $V_{GS}$	-10 to 3 V
Gate Current, $I_G$	12 mA
Junction Temperature, $T_J$	+200°C
Operating Temperature	-40°C to +85°C
Storage Temperature	-65°C to +150°C
ESD Min. - Human Body Model (HBM)	+500 V

3. Exceeding any one or combination of these limits may cause permanent damage to this device.
4. MACOM does not recommend sustained operation near these survivability limits.
5. Operating at nominal conditions with  $T_J \leq 200^\circ\text{C}$  will ensure  $\text{MTTF} > 1 \times 10^6$  hours.

## Thermal Characteristics<sup>6</sup>

Parameter	Test Conditions	Symbol	Typical	Units
Thermal Resistance	$V_{DS} = 28 \text{ V}, T_J = 200^\circ\text{C}$	$\Theta_{JC}$	4.6	°C/W

6. Junction temperature ( $T_J$ ) measured using IR Microscopy. Case temperature measured using thermocouple embedded in heat-sink.

## Handling Procedures

Please observe the following precautions to avoid damage:

## Static Sensitivity

Gallium Nitride Circuits are sensitive to electrostatic discharge (ESD) and can be damaged by static electricity. Proper ESD control techniques should be used when handling these HBM Class 1B devices.

## Characterization Circuit and Recommended Tuning Solution

100 - 1000 MHz Broadband

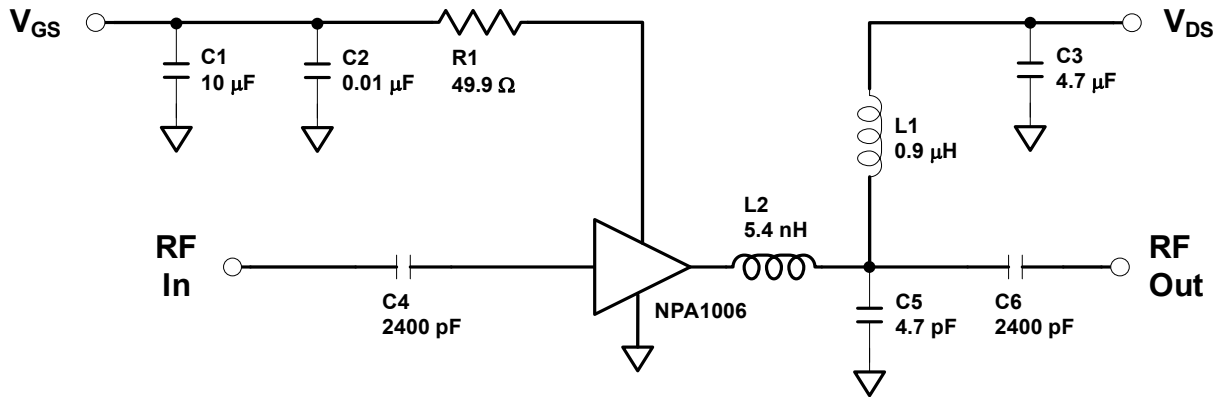

### Description

Parts measured on the characterization board (20-mil thick RO4350). The PCB's electrical and thermal ground is provided using a standard-plated densely packed via hole array (see recommended via pattern).

Matching is provided using a combination of lumped elements and transmission lines as shown in the simplified schematic above. Recommended tuning solution component placement, transmission lines, and details are shown on the next page.

### Bias Sequencing

#### Turning the device ON

1. Set  $V_{GS}$  to the pinch-off ( $V_P$ ), typically -5 V.
2. Turn on  $V_{DS}$  to nominal voltage (28 V).
3. Increase  $V_{GS}$  until the  $I_{DS}$  current is reached.
4. Apply RF power to desired level.

#### Turning the device OFF

1. Turn the RF power off.
2. Decrease  $V_{GS}$  down to  $V_P$ .
3. Decrease  $V_{DS}$  down to 0 V.
4. Turn off  $V_{GS}$ .

### Recommended Via Pattern (All dimensions shown as inches)

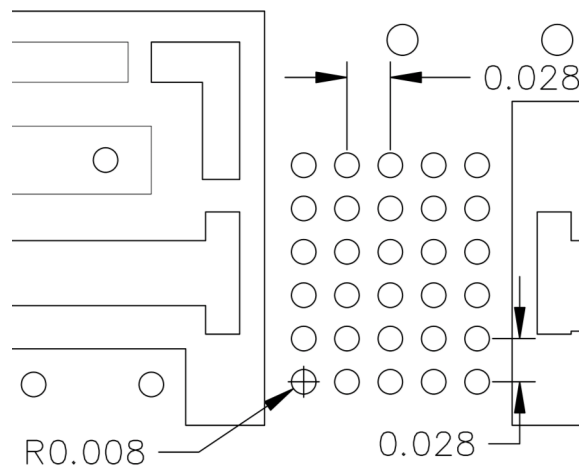

## Characterization Circuit and Recommended Tuning Solution

100 - 1000 MHz Broadband

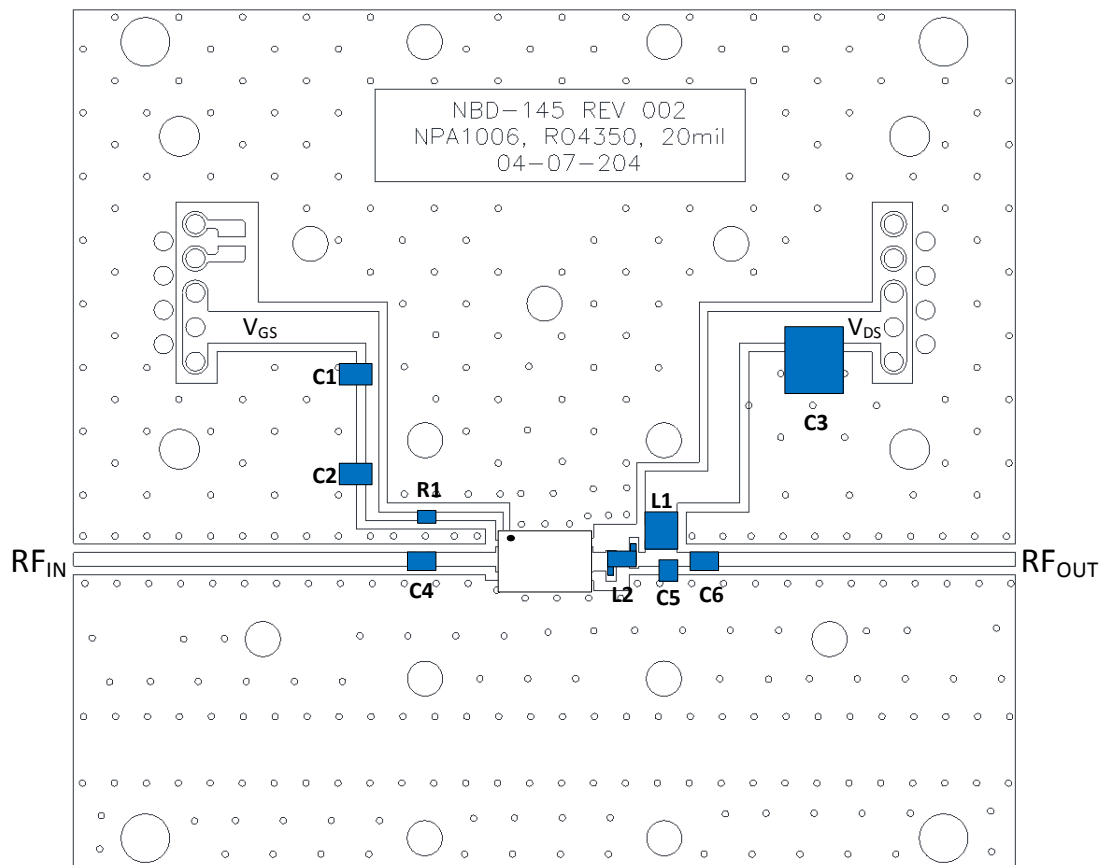

### Parts List

Reference	Value	Tolerance	Manufacturer	Part Number
C1	10 $\mu$ F	20%	TDK	C2012X5R1C106M085AC
C2	0.01 $\mu$ F	10%	AVX	06031C103JAT2A
C3	4.7 $\mu$ F	10%	TDK	C5750X7R2A475K230KA
C4, C6	2400 pF	-	Dielectric Labs, Inc.	C08BL242X-5UN-X0
C5	4.7 pF	0.1 pF	Murata	GQM2195C2E4R7BB12
R1	49.9 $\Omega$	1%	Panasonic	ERJ-6ENF49R9V
L1	0.9 $\mu$ H	10%	Coilcraft	1008AF-901XJLC
L2	5.4 nH	5%	Coilcraft	0906-5_LB
PCB	Rogers RO4350, $\epsilon_r=3.5$ , 0.020"			
Heat Sink	Copper Heat Sink 3.0" x 2.75"			

## GaN Wideband Power Amplifier, 28 V, 12.5 W 20 - 1000 MHz

Rev. V2

Typical Performance as measured in the Broadband 100 - 1000 MHz Characterization  
Circuit: CW,  $V_{DS} = 28$  V,  $I_{DQ} = 88$  mA (unless otherwise noted)

Deembedded device S-Parameters with  $R_G = 470 \Omega$

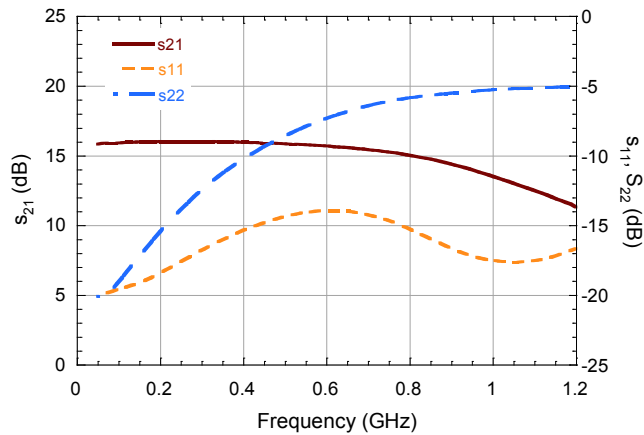

Broadband Circuit S-Parameters

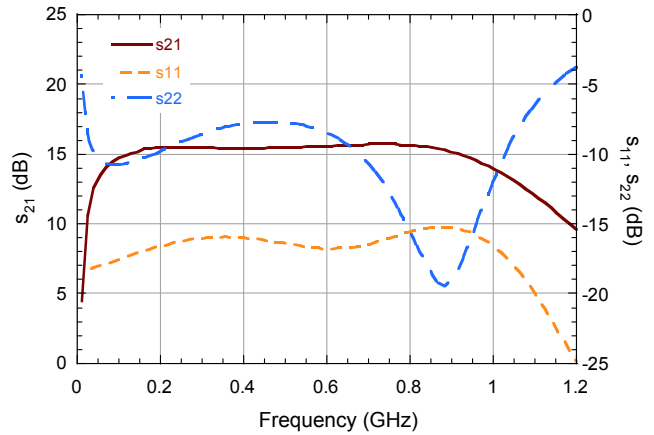

Performance vs. Frequency at  $P_{OUT} = 41$  dBm

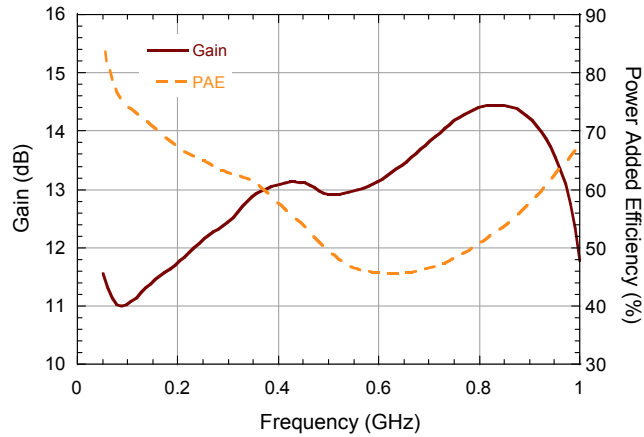

Performance vs. Input Return Loss at  $P_{OUT} = 41$  dBm

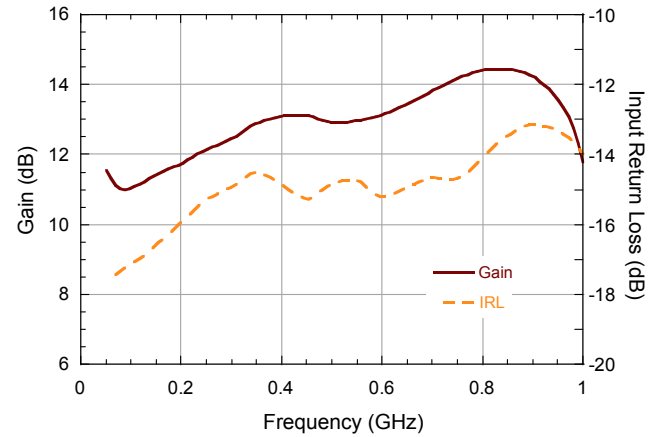

## GaN Wideband Power Amplifier, 28 V, 12.5 W 20 - 1000 MHz

Rev. V2

Typical Performance as measured in the Broadband 100 - 1000 MHz Characterization Circuit: CW,  $V_{DS} = 28$  V,  $I_{DQ} = 88$  mA (unless otherwise noted)

Gain vs. Frequency

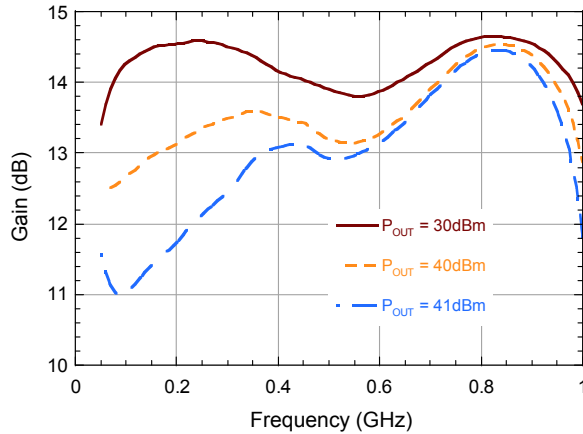

Gain vs. Frequency at  $P_{IN} = 27$  dBm

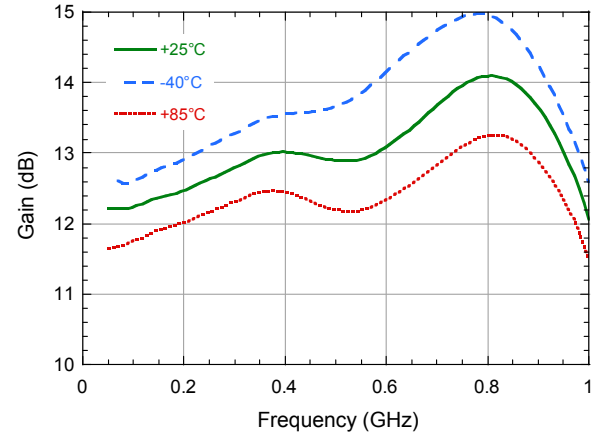

Input Return Loss vs. Frequency

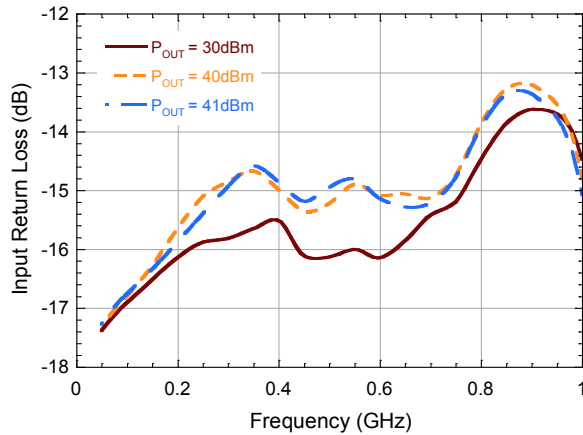

Input Return Loss at  $P_{IN} = 27$  dBm vs. Frequency

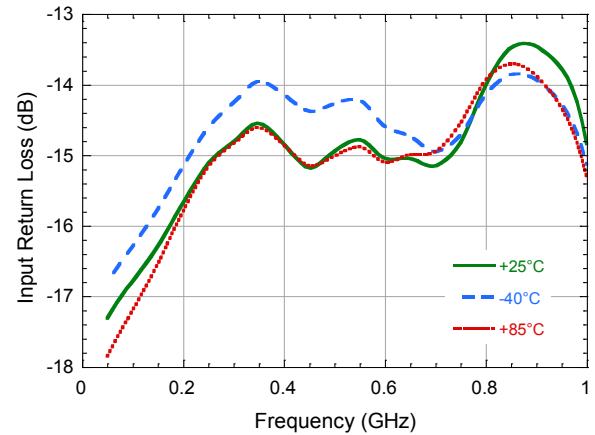

Power Added Efficiency vs. Frequency

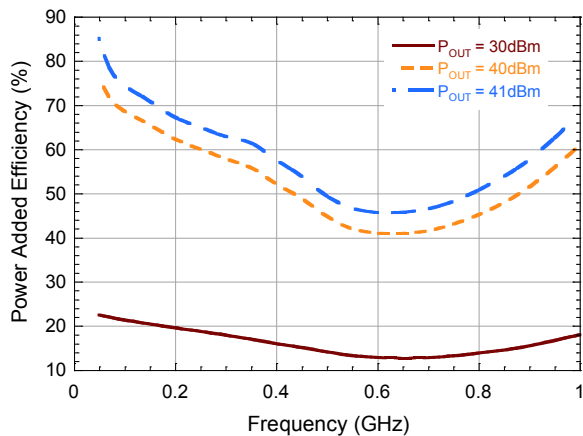

Power Added Efficiency at  $P_{IN} = 27$  dBm vs. Frequency

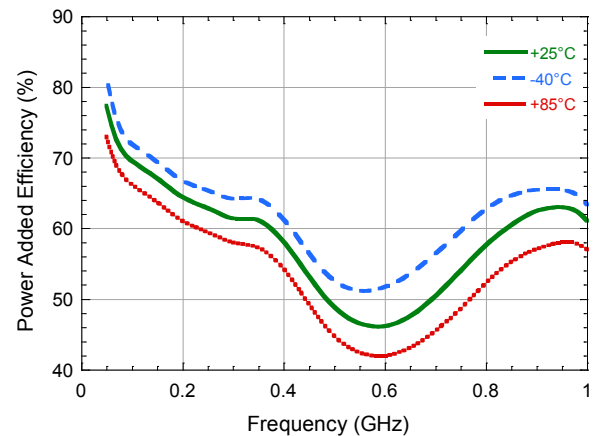

## GaN Wideband Power Amplifier, 28 V, 12.5 W 20 - 1000 MHz

Rev. V2

Typical Performance as measured in the Broadband 100 - 1000 MHz Characterization Circuit: CW,  $V_{DS} = 28\text{ V}$ ,  $I_{DQ} = 88\text{ mA}$  (unless otherwise noted)

Gain vs.  $P_{OUT}$

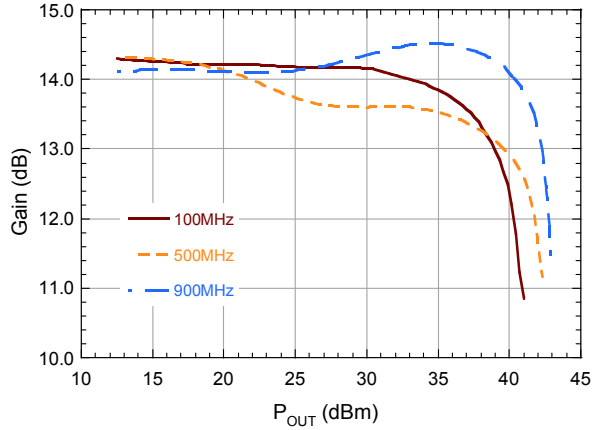

Power Added Efficiency vs.  $P_{OUT}$

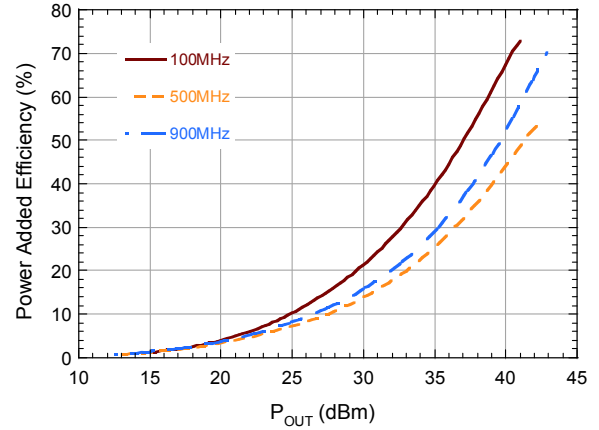

Input Return Loss vs.  $P_{OUT}$

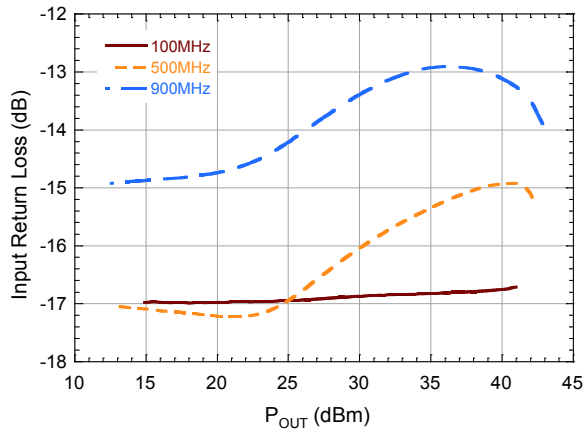

Quiescent  $V_{GS}$  vs. Temperature

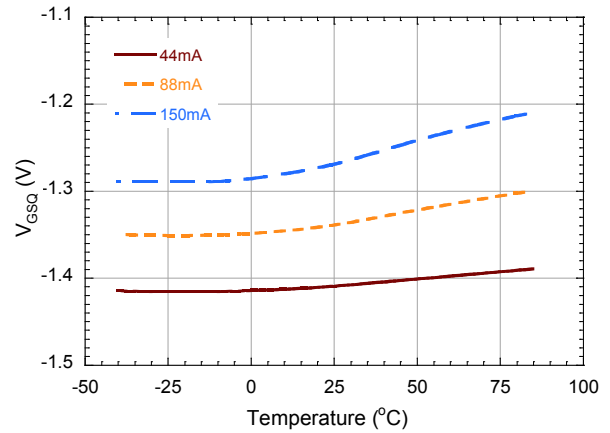



## GaN Wideband Power Amplifier, 28 V, 12.5 W 20 - 1000 MHz

Rev. V2

Typical 2-Tone Performance as measured in the Broadband 100 - 1000 MHz Characterization Circuit: 1 MHz Tone Spacing,  $V_{DS} = 28$  V,  $I_{DQ} = 88$  mA (unless otherwise noted)

2-Tone IMD vs. Output Power vs.  $I_{DQ}$

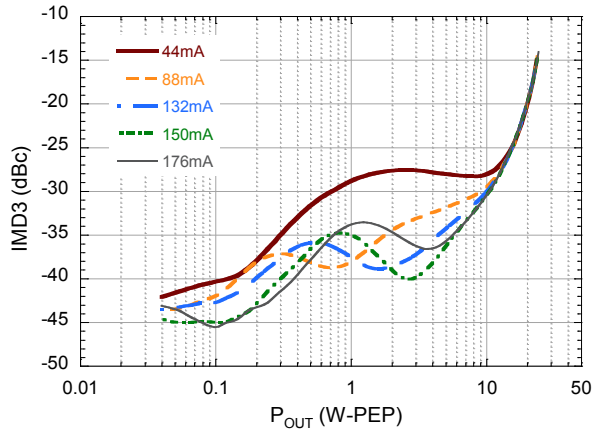

2-Tone Gain vs. Output Power vs.  $I_{DQ}$

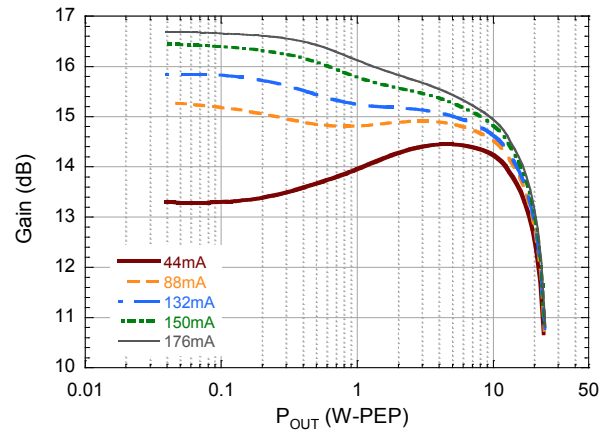

2-Tone IMD vs. Output Power  
(1 MHz Tone Spacing,  $I_{DQ} = 132$  mA,  $F = 450$  MHz)

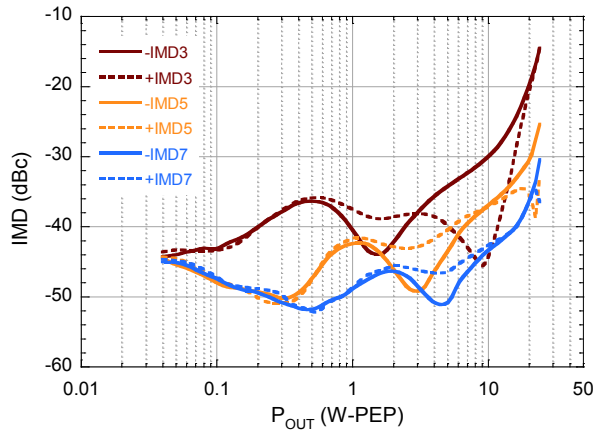

2-Tone IMD vs. Tone Spacing  
( $P_{OUT} = 41$  dBm-PEP,  $I_{DQ} = 132$  mA,  $F = 450$  MHz)

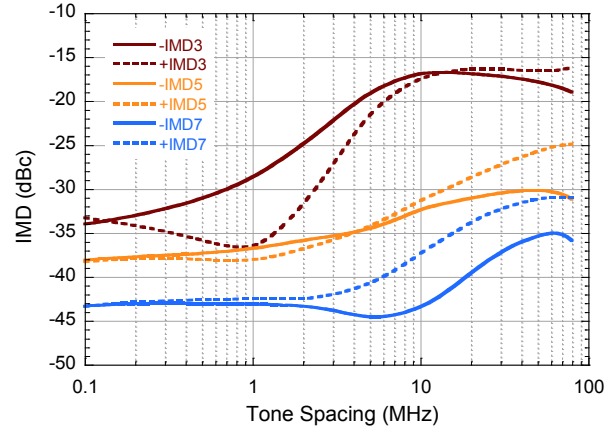

**Sample Board and Recommended Tuning Solution**  
**20 - 1000 MHz Broadband Circuit (NPA1006-SMB)**

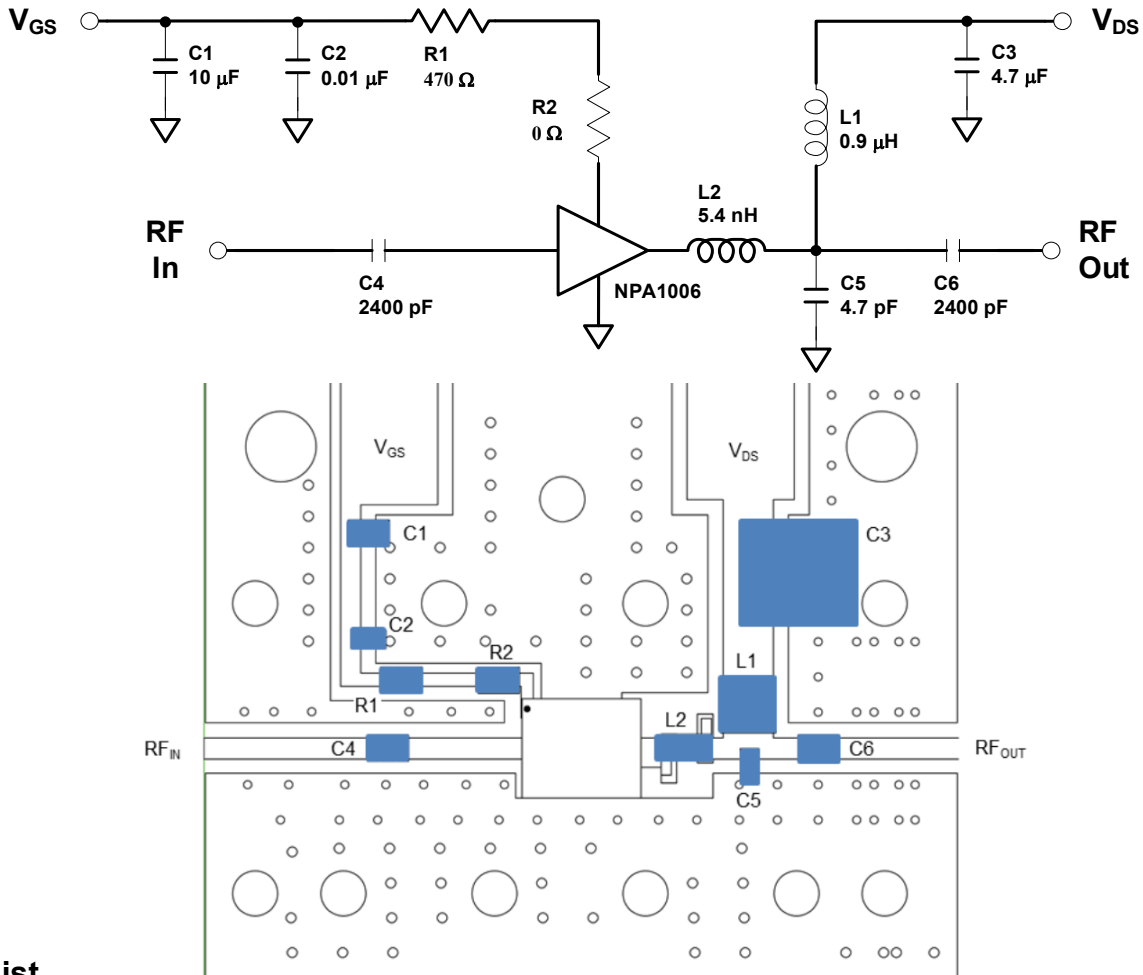

**Parts List**

Reference	Value	Tolerance	Manufacturer	Part Number
C1	10 µF	20%	TDK	C2012X5R1C106M085AC
C2	0.01 µF	10%	AVX	06031C103JAT2A
C3	4.7 µF	10%	TDK	C5750X7R2A475K230KA
C4, C6	2400 pF	-	Dielectric Labs, Inc.	C08BL242X-5UN-X0
C5	4.7 pF	0.1 pF	Murata	GQM2195C2E4R7BB12
R1	470 Ω	1%	Panasonic	ERJ-3EKF4700V
R2	0 Ω	-	Panasonic	ERJ-6GEY0R00V
L1	0.9 µH	10%	Coilcraft	1008AF-901XJLC
L2	5.4 nH	5%	Coilcraft	0906-5_LB
PCB	Rogers RO4350, $\epsilon_r=3.5$ , 0.020"			
Al Heat Sink	Aluminum Heat sink			

## GaN Wideband Power Amplifier, 28 V, 12.5 W 20 - 1000 MHz

Rev. V2

Typical Performance as measured in the Broadband 20 - 1000 MHz Sample Board:  
CW,  $V_{DS} = 28\text{ V}$ ,  $I_{DQ} = 88\text{ mA}$  (unless otherwise noted)

Performance vs. Frequency at  $P_{OUT} = P_{SAT}$

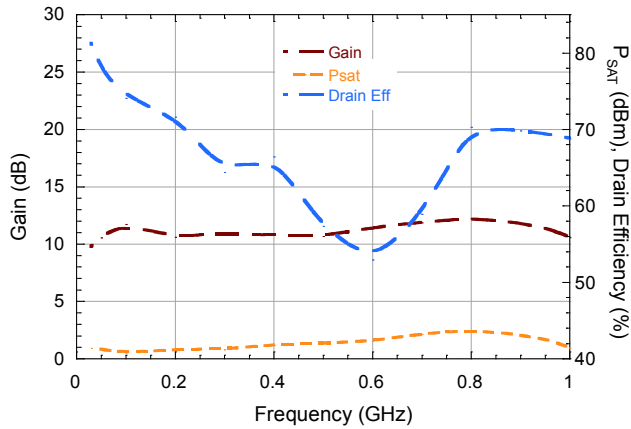

Performance vs. Frequency at  $P_{OUT} = 41\text{ dBm}$

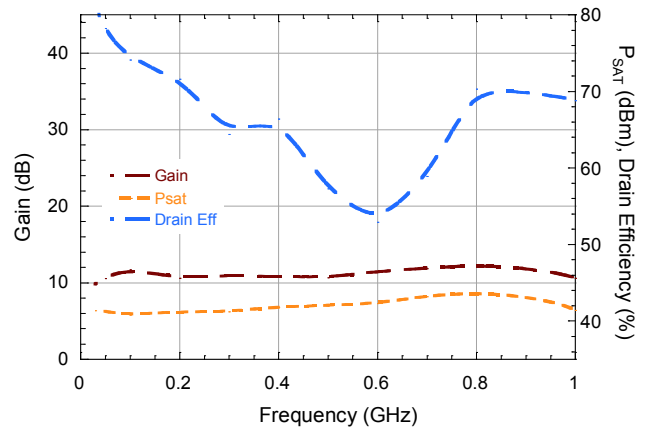

Performance vs. Output Power ( $f = 900\text{ MHz}$ )

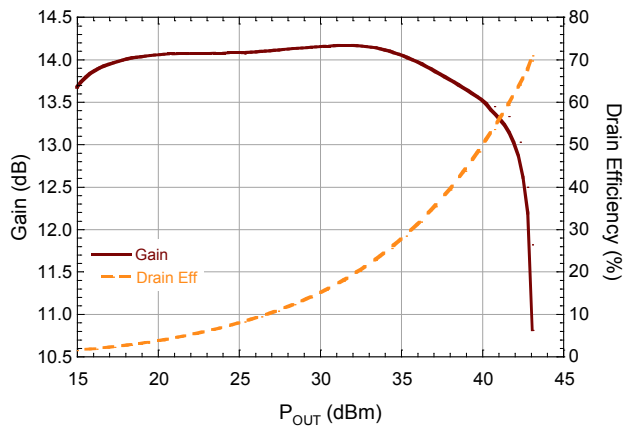

Small Signal S-Parameters vs. Frequency

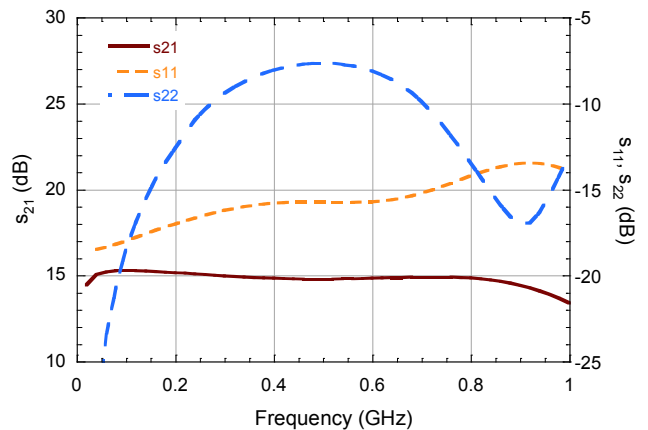

**Lead-Free 6 x 5 mm 8-Lead PDFN†**

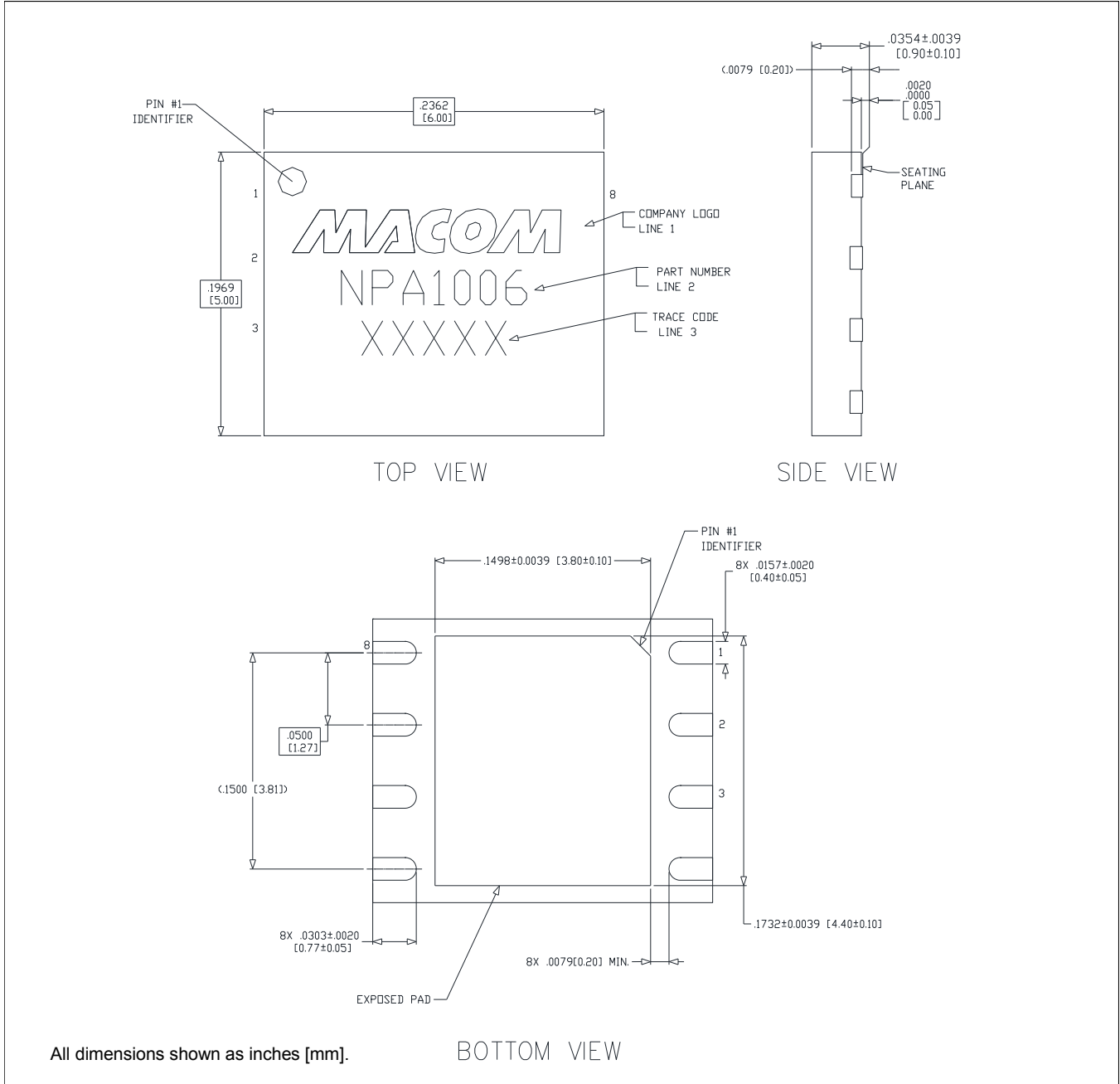

† Meets JEDEC moisture sensitivity level 3 requirements.  
 Plating is Ni/Pd/Au

M/A-COM Technology Solutions Inc. All rights reserved.

Information in this document is provided in connection with M/A-COM Technology Solutions Inc ("MACOM") products. These materials are provided by MACOM as a service to its customers and may be used for informational purposes only. Except as provided in MACOM's Terms and Conditions of Sale for such products or in any separate agreement related to this document, MACOM assumes no liability whatsoever. MACOM assumes no responsibility for errors or omissions in these materials. MACOM may make changes to specifications and product descriptions at any time, without notice. MACOM makes no commitment to update the information and shall have no responsibility whatsoever for conflicts or incompatibilities arising from future changes to its specifications and product descriptions. No license, express or implied, by estoppel or otherwise, to any intellectual property rights is granted by this document.

THESE MATERIALS ARE PROVIDED "AS IS" WITHOUT WARRANTY OF ANY KIND, EITHER EXPRESS OR IMPLIED, RELATING TO SALE AND/OR USE OF MACOM PRODUCTS INCLUDING LIABILITY OR WARRANTIES RELATING TO FITNESS FOR A PARTICULAR PURPOSE, CONSEQUENTIAL OR INCIDENTAL DAMAGES, MERCHANTABILITY, OR INFRINGEMENT OF ANY PATENT, COPYRIGHT OR OTHER INTELLECTUAL PROPERTY RIGHT. MACOM FURTHER DOES NOT WARRANT THE ACCURACY OR COMPLETENESS OF THE INFORMATION, TEXT, GRAPHICS OR OTHER ITEMS CONTAINED WITHIN THESE MATERIALS. MACOM SHALL NOT BE LIABLE FOR ANY SPECIAL, INDIRECT, INCIDENTAL, OR CONSEQUENTIAL DAMAGES, INCLUDING WITHOUT LIMITATION, LOST REVENUES OR LOST PROFITS, WHICH MAY RESULT FROM THE USE OF THESE MATERIALS.

MACOM products are not intended for use in medical, lifesaving or life sustaining applications. MACOM customers using or selling MACOM products for use in such applications do so at their own risk and agree to fully indemnify MACOM for any damages resulting from such improper use or sale.