

# NE3521M04

Data Sheet  
R09DS0058EJ0100  
Rev.1.00  
Mar 19, 2013

N-Channel GaAs HJ-FET, K Band Low Noise and High-Gain

## FEATURES

- Low noise figure and high associated gain:  
 $NF = 0.85 \text{ dB TYP.}, Ga = 11 \text{ dB TYP. @ } V_{DS} = 2 \text{ V}, I_D = 10 \text{ mA}, f = 20 \text{ GHz}$   
 $NF = 0.9 \text{ dB TYP.}, Ga = 10.5 \text{ dB TYP. @ } V_{DS} = 2 \text{ V}, I_D = 6 \text{ mA}, f = 20 \text{ GHz}$  (Reference Value)
- Flat-lead 4-pin thin-type super minimold (M04) package

## APPLICATIONS

- DBS LNB gain-stage, Mix-stage
- Low noise amplifier for microwave communication system

## ORDERING INFORMATION

Part Number	Order Number	Package	Quantity	Marking	Supplying Form
NE3521M04-T2	NE3521M04-T2-A	Flat-lead 4-pin thin-type super minimold (M04) (Pb-Free)	3 kpcs/reel	V86	<ul style="list-style-type: none"> <li>• Embossed tape 8 mm wide</li> <li>• Pin 1 (Source), Pin 2 (Drain) face the perforation side of the tape</li> </ul>
NE3521M04-T2B	NE3521M04-T2B-A		15 kpcs/reel		

**Remark** To order evaluation samples, contact your nearby sales office.  
Part number for sample order: NE3521M04-A

## ABSOLUTE MAXIMUM RATINGS ( $T_A = +25^\circ\text{C}$ , unless otherwise specified)

Parameter	Symbol	Ratings	Unit
Drain to Source Voltage	$V_{DS}$	4.0	V
Gate to Source Voltage	$V_{GS}$	-3.0	V
Drain Current	$I_D$	$I_{DSS}$	mA
Gate Current	$I_G$	80	$\mu\text{A}$
Total Power Dissipation <sup>Note</sup>	$P_{tot}$	125	mW
Channel Temperature	$T_{ch}$	+125	$^\circ\text{C}$
Storage Temperature	$T_{stg}$	-65 to +125	$^\circ\text{C}$

Note: Mounted on  $1.08 \text{ cm}^2 \times 1.0 \text{ mm}$  (t) glass epoxy PWB

### CAUTION

Observe precautions when handling because these devices are sensitive to electrostatic discharge.

**RECOMMENDED OPERATING RANGE ( $T_A = +25^\circ\text{C}$ , unless otherwise specified)**

Parameter	Symbol	MIN.	TYP.	MAX.	Unit
Drain to Source Voltage	$V_{DS}$	1	2	3	V
Drain Current	$I_D$	3	10	15	mA
Input Power	$P_{in}$	–	–	0	dBm

**ELECTRICAL CHARACTERISTICS ( $T_A = +25^\circ\text{C}$ , unless otherwise specified)**

Parameter	Symbol	Test Conditions	MIN.	TYP.	MAX.	Unit
Gate to Source Leak Current	$I_{GSO}$	$V_{GS} = -3.0\text{ V}$	–	0.5	10	$\mu\text{A}$
Saturated Drain Current	$I_{DSS}$	$V_{DS} = 2\text{ V}, V_{GS} = 0\text{ V}$	25	45	70	mA
Gate to Source Cut-off Voltage	$V_{GS(off)}$	$V_{DS} = 2\text{ V}, I_D = 100\ \mu\text{A}$	-0.2	-0.7	-1.3	V
Transconductance	gm	$V_{DS} = 2\text{ V}, I_D = 10\text{ mA}$	50	–	–	mS
Noise Figure	NF	$V_{DS} = 2\text{ V}, I_D = 10\text{ mA}, f = 20\text{ GHz}$	–	0.85	1.2	dB
Associated Gain	Ga		9	11	–	dB

**STANDARD CHARACTERISTICS FOR REFERENCE  
( $T_A = +25^\circ\text{C}$ , unless otherwise specified)**

Parameter	Symbol	Test Conditions	Reference Value	Unit
Noise Figure	NF	$V_{DS} = 2\text{ V}, I_D = 6\text{ mA}, f = 20\text{ GHz}$	0.9	dB
Associated Gain	Ga		10.5	dB

**TYPICAL CHARACTERISTICS (T<sub>A</sub> = +25°C, unless otherwise specified)**

**TOTAL POWER DISSIPATION vs. AMBIENT TEMPERATURE**

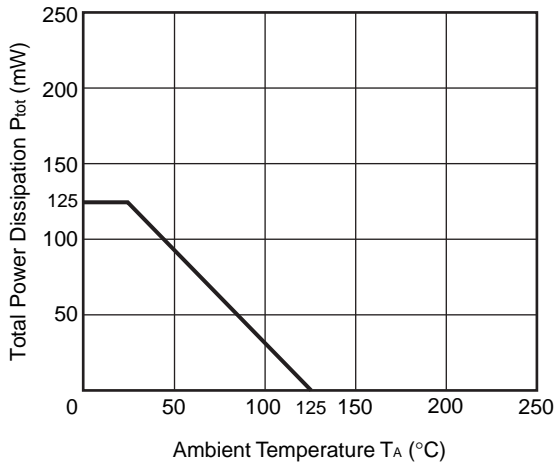

**DRAIN CURRENT vs. GATE TO SOURCE VOLTAGE**

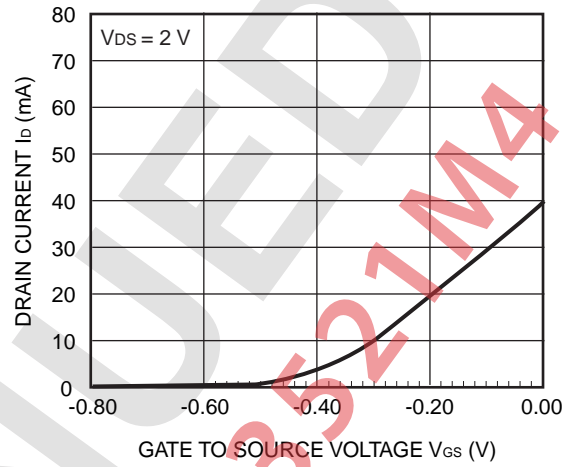

**MINIMUM NOISE FIGURE, ASSOCIATED GAIN vs. DRAIN CURRENT**

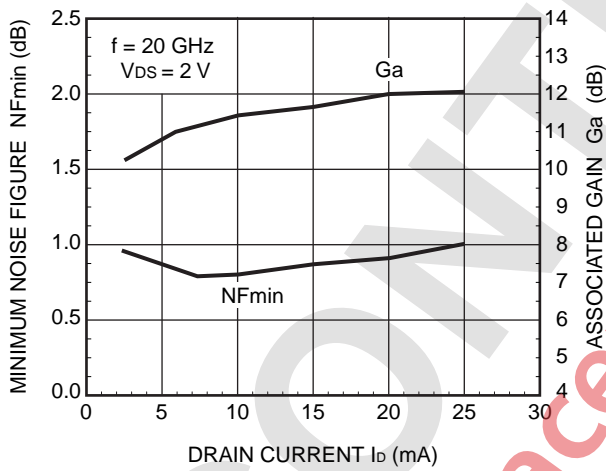

**DRAIN CURRENT vs. DRAIN TO SOURCE VOLTAGE**

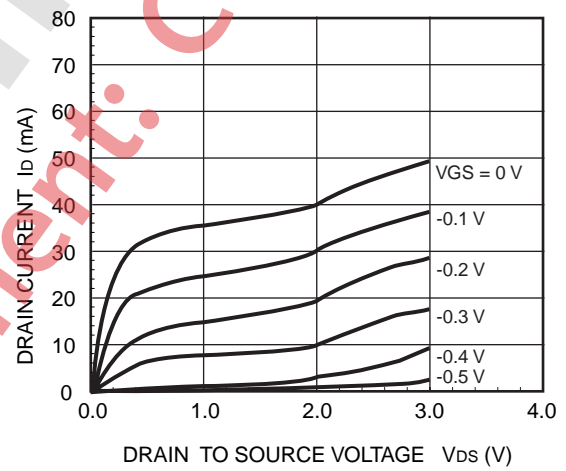

**MINIMUM NOISE FIGURE, ASSOCIATED GAIN vs. FREQUENCY**

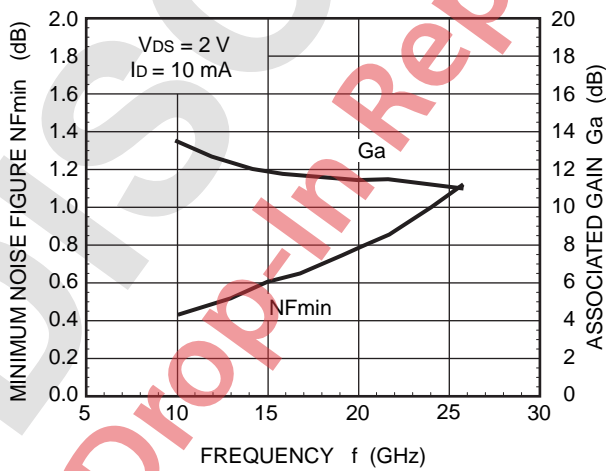

**Remark** The graphs indicate nominal characteristics.

## S-PARAMETERS

S-parameters and noise parameters are provided on our web site in a form (S2P) that enables direct import of the parameters to microwave circuit simulators without the need for keyboard inputs.

Click here to download S-parameters.

[Products] → [RF Devices] → [Device Parameters]

URL <http://www.renesas.com/products/microwave/>

**DISCONTINUED**  
**Drop-In Replacement: CE3521M4**

**PACKAGE DIMENSIONS**

FLAT-LEAD 4-PIN THIN-TYPE SUPER MINIMOLD (M04) (UNIT: mm)

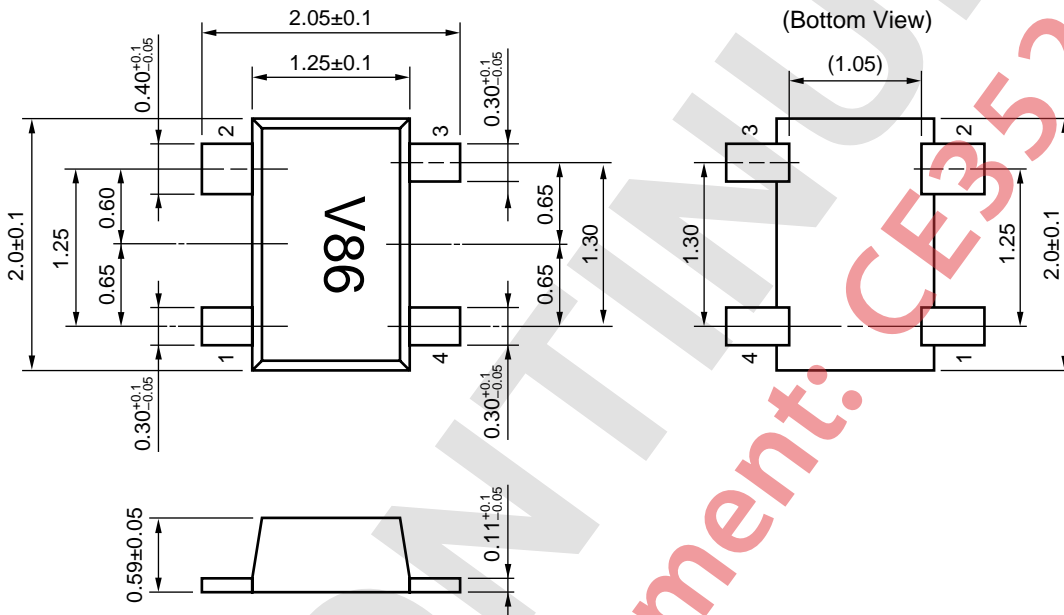
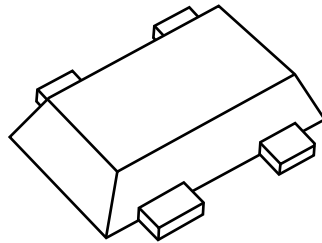

**PIN CONNECTIONS**

- 1. Source
- 2. Drain
- 3. Source
- 4. Gate

**MOUNTING PAD DIMENSIONS**

FLAT-LEAD 4-PIN THIN-TYPE SUPER MINIMOLD (M04) (UNIT: mm)

-Reference 1-

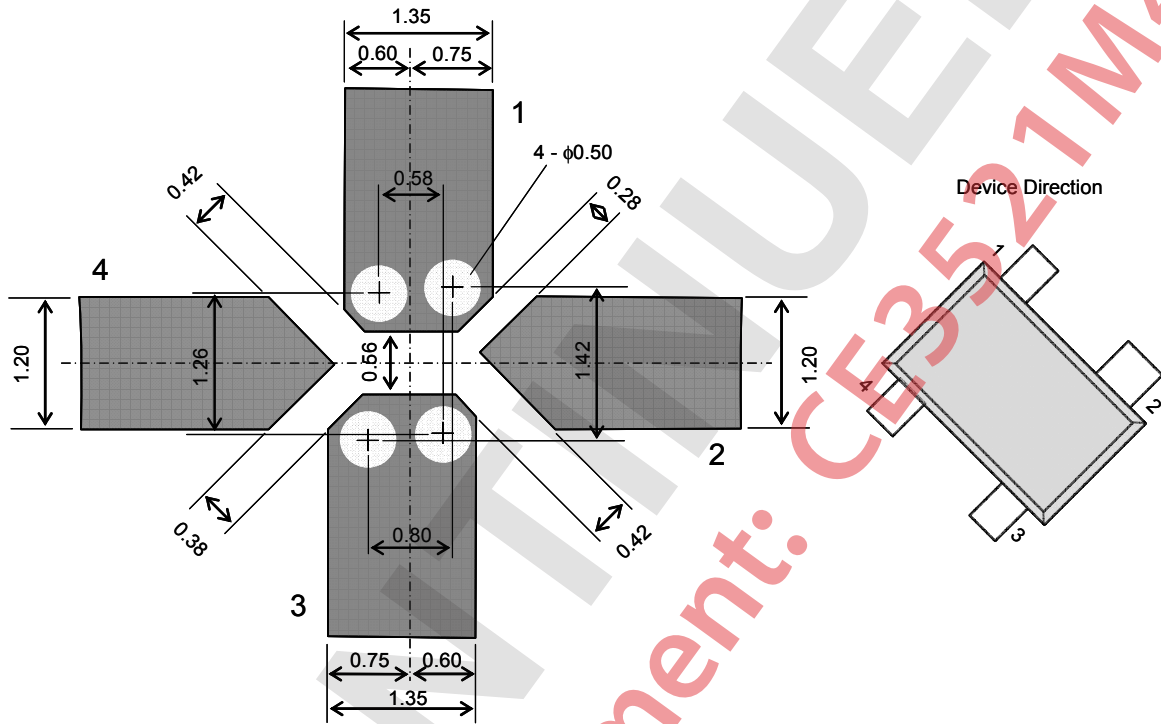

-Reference 2-

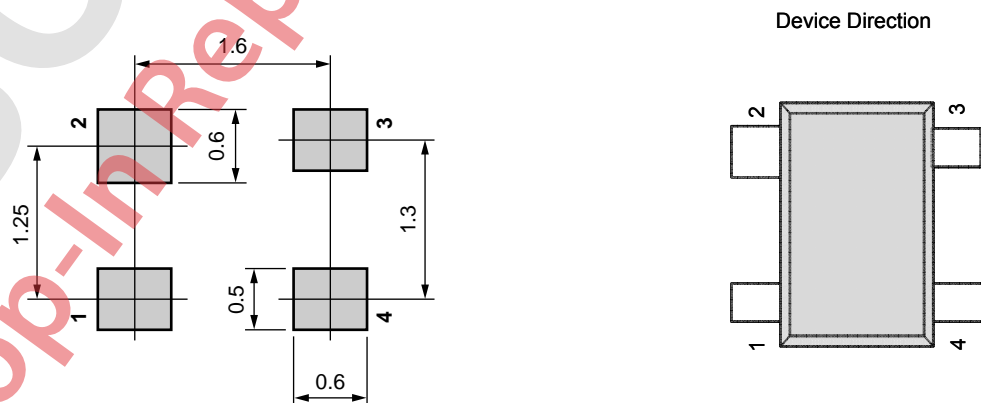

**Remark** The mounting pad layout in this document is for reference only.

**RECOMMENDED SOLDERING CONDITIONS**

This product should be soldered and mounted under the following recommended conditions. For soldering methods and conditions other than those recommended below, contact your nearby sales office.

Soldering Method	Soldering Conditions	Condition Symbol
Infrared Reflow	Peak temperature (package surface temperature) : 260°C or below Time at peak temperature : 10 seconds or less Time at temperature of 220°C or higher : 60 seconds or less Preheating time at 120 to 180°C : 120±30 seconds Maximum number of reflow processes : 3 times Maximum chlorine content of rosin flux (% mass) : 0.2% (Wt.) or below	IR260
Partial Heating	Peak temperature (package surface temperature) : 350°C or below Soldering time (per side of device) : 3 seconds or less Maximum chlorine content of rosin flux (% mass) : 0.2% (Wt.) or below	HS350

**CAUTION**

Do not use different soldering methods together (except for partial heating).

<b>Caution</b> GaAs Products	<p>This product uses gallium arsenide (GaAs). GaAs vapor and powder are hazardous to human health if inhaled or ingested, so please observe the following points.</p> <ul style="list-style-type: none"><li>• Follow related laws and ordinances when disposing of the product. If there are no applicable laws and/or ordinances, dispose of the product as recommended below.</li></ul> <ol style="list-style-type: none"><li>1. Commission a disposal company able to (with a license to) collect, transport and dispose of materials that contain arsenic and other such industrial waste materials.</li><li>2. Exclude the product from general industrial waste and household garbage, and ensure that the product is controlled (as industrial waste subject to special control) up until final disposal.</li></ol> <ul style="list-style-type: none"><li>• Do not burn, destroy, cut, crush, or chemically dissolve the product.</li><li>• Do not lick the product or in any way allow it to enter the mouth.</li></ul>
------------------------------	---

DISCONTINUED  
Drop-In Replacement: CE3521M4



<b>Revision History</b>	<b>NE3521M04 Data Sheet</b>
-------------------------	-----------------------------

Rev.	Date	Description	
		Page	Summary
1.00	Mar 19, 2013	-	First edition issued

DISCONTINUED

Drop-In Replacement: CE3521M4

All trademarks and registered trademarks are the property of their respective owners.
---

## NOTICE

1. Descriptions of circuits, software and other related information in this document are provided only to illustrate the operation of semiconductor products and application examples. You are fully responsible for the incorporation of these circuits, software, and information in the design of your equipment. California Eastern Laboratories and Renesas Electronics assumes no responsibility for any losses incurred by you or third parties arising from the use of these circuits, software, or information.
2. California Eastern Laboratories has used reasonable care in preparing the information included in this document, but California Eastern Laboratories does not warrant that such information is error free. California Eastern Laboratories and Renesas Electronics assumes no liability whatsoever for any damages incurred by you resulting from errors in or omissions from the information included herein.
3. California Eastern Laboratories and Renesas Electronics do not assume any liability for infringement of patents, copyrights, or other intellectual property rights of third parties by or arising from the use of Renesas Electronics products or technical information described in this document. No license, express, implied or otherwise, is granted hereby under any patents, copyrights or other intellectual property rights of California Eastern Laboratories or Renesas Electronics or others.
4. You should not alter, modify, copy, or otherwise misappropriate any Renesas Electronics product, whether in whole or in part. California Eastern Laboratories and Renesas Electronics assume no responsibility for any losses incurred by you or third parties arising from such alteration, modification, copy or otherwise misappropriation of Renesas Electronics product.
5. Renesas Electronics products are classified according to the following two quality grades: "Standard" and "High Quality". The recommended applications for each Renesas Electronics product depends on the product's quality grade, as indicated below. "Standard": Computers; office equipment; communications equipment; test and measurement equipment; audio and visual equipment; home electronic appliances; machine tools; personal electronic equipment; and industrial robots etc. "High Quality": Transportation equipment (automobiles, trains, ships, etc.); traffic control systems; anti-disaster systems; anti-crime systems; and safety equipment etc. Renesas Electronics products are neither intended nor authorized for use in products or systems that may pose a direct threat to human life or bodily injury (artificial life support devices or systems, surgical implantations etc.), or may cause serious property damages (nuclear reactor control systems, military equipment etc.). You must check the quality grade of each Renesas Electronics product before using it in a particular application. You may not use any Renesas Electronics product for any application for which it is not intended. California Eastern Laboratories and Renesas Electronics shall not be in any way liable for any damages or losses incurred by you or third parties arising from the use of any Renesas Electronics product for which the product is not intended by California Eastern Laboratories or Renesas Electronics.
6. You should use the Renesas Electronics products described in this document within the range specified by California Eastern Laboratories, especially with respect to the maximum rating, operating supply voltage range, movement power voltage range, heat radiation characteristics, installation and other product characteristics. California Eastern Laboratories shall have no liability for malfunctions or damages arising out of the use of Renesas Electronics products beyond such specified ranges.
7. Although Renesas Electronics endeavors to improve the quality and reliability of its products, semiconductor products have specific characteristics such as the occurrence of failure at a certain rate and malfunctions under certain use conditions. Further, Renesas Electronics products are not subject to radiation resistance design. Please be sure to implement safety measures to guard them against the possibility of physical injury, and injury or damage caused by fire in the event of the failure of a Renesas Electronics product, such as safety design for hardware and software including but not limited to redundancy, fire control and malfunction prevention, appropriate treatment for aging degradation or any other appropriate measures. Because the evaluation of microcomputer software alone is very difficult, please evaluate the safety of the final products or systems manufactured by you.
8. Please contact a California Eastern Laboratories sales office for details as to environmental matters such as the environmental compatibility of each Renesas Electronics product. Please use Renesas Electronics products in compliance with all applicable laws and regulations that regulate the inclusion or use of controlled substances, including without limitation, the EU RoHS Directive. California Eastern Laboratories and Renesas Electronics assume no liability for damages or losses occurring as a result of your noncompliance with applicable laws and regulations.
9. Renesas Electronics products and technology may not be used for or incorporated into any products or systems whose manufacture, use, or sale is prohibited under any applicable domestic or foreign laws or regulations. You should not use Renesas Electronics products or technology described in this document for any purpose relating to military applications or use by the military, including but not limited to the development of weapons of mass destruction. When exporting the Renesas Electronics products or technology described in this document, you should comply with the applicable export control laws and regulations and follow the procedures required by such laws and regulations.
10. It is the responsibility of the buyer or distributor of California Eastern Laboratories, who distributes, disposes of, or otherwise places the Renesas Electronics product with a third party, to notify such third party in advance of the contents and conditions set forth in this document, California Eastern Laboratories and Renesas Electronics assume no responsibility for any losses incurred by you or third parties as a result of unauthorized use of Renesas Electronics products.
11. This document may not be reproduced or duplicated in any form, in whole or in part, without prior written consent of California Eastern Laboratories.
12. Please contact a California Eastern Laboratories sales office if you have any questions regarding the information contained in this document or Renesas Electronics products, or if you have any other inquiries.

**NOTE 1:** "Renesas Electronics" as used in this document means Renesas Electronics Corporation and also includes its majority-owned subsidiaries.

**NOTE 2:** "Renesas Electronics product(s)" means any product developed or manufactured by or for Renesas Electronics.

**NOTE 3:** Products and product information are subject to change without notice.

**CEL Headquarters** • 4590 Patrick Henry Drive, Santa Clara, CA 95054 • Phone (408) 919-2500 • [www.cel.com](http://www.cel.com)

For a complete list of sales offices, representatives and distributors,  
Please visit our website: [www.cel.com/contactus](http://www.cel.com/contactus)