

Silicon Super Fast Recovery Diode

$V_{RRM} = 50\text{ V} - 200\text{ V}$

$I_{F(AV)} = 300\text{ A}$

Features

- High Surge Capability
- Types from 50 V to 200 V V_{RRM}
- Isolation Type Package
- Electrically Isolated base plate
- Not ESD Sensitive

Three Tower Package

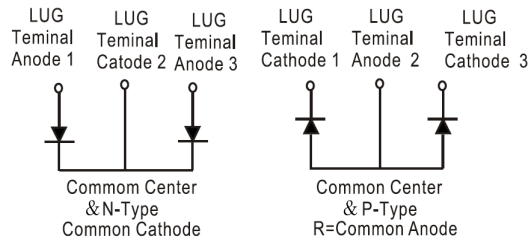

Maximum ratings, at $T_j = 25\text{ }^\circ\text{C}$, unless otherwise specified ("R" devices have leads reversed)

Parameter	Symbol	Conditions	MURT30005(R)	MURT30010(R)	MURT30020(R)	Unit
Repetitive peak reverse voltage	V_{RRM}		50	100	200	V
RMS reverse voltage	V_{RMS}		35	71	141	V
DC blocking voltage	V_{DC}		50	100	200	V
Operating temperature	T_j		-55 to 150	-55 to 150	-55 to 150	$^\circ\text{C}$
Storage temperature	T_{stg}		-55 to 150	-55 to 150	-55 to 150	$^\circ\text{C}$

Electrical characteristics, at $T_j = 25\text{ }^\circ\text{C}$, unless otherwise specified

Parameter	Symbol	Conditions	MURT30005(R)	MURT30010(R)	MURT30020(R)	Unit
Average forward current (per pkg)	$I_{F(AV)}$	$T_C = 125\text{ }^\circ\text{C}$	300	300	300	A
Peak forward surge current (per leg)	I_{FSM}	$t_p = 8.3\text{ ms}$, half sine	2750	2750	2750	A
Maximum instantaneous forward voltage (per leg)	V_F	$I_{FM} = 150\text{ A}$, $T_j = 25\text{ }^\circ\text{C}$	1.0	1.0	1.0	V
Maximum instantaneous reverse current at rated DC blocking voltage (per leg)	I_R	$T_j = 25\text{ }^\circ\text{C}$	25	25	25	μA
		$T_j = 125\text{ }^\circ\text{C}$	2	2	2	mA
Maximum reverse recovery time (per leg)	T_{rr}	$I_F = 0.5\text{ A}$, $I_R = 1.0\text{ A}$, $I_{RR} = 0.25\text{ A}$	100	100	100	nS

Thermal characteristics

Thermal resistance, junction - case (per leg)	$R_{\theta JC}$		0.40	0.40	0.40	$^\circ\text{C/W}$
---	-----------------	--	------	------	------	--------------------

Figure .1- Typical Forward Characteristics

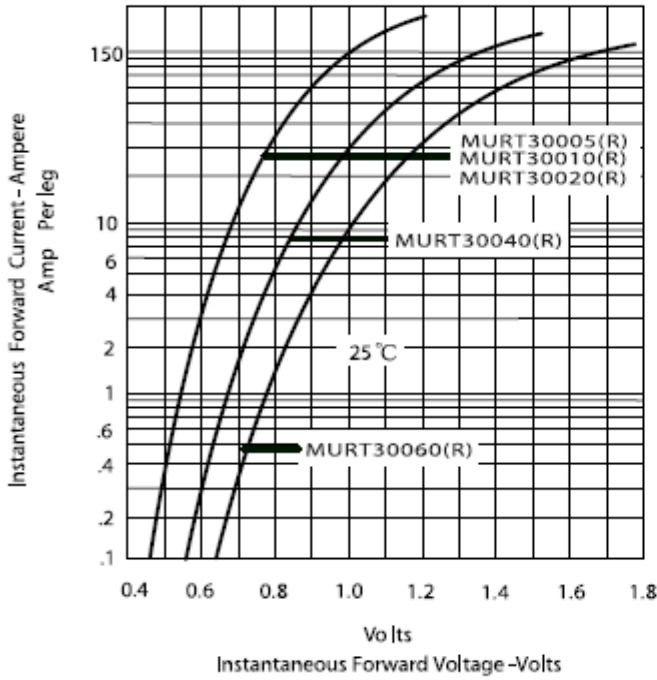

Figure .2- Forward Derating Curve

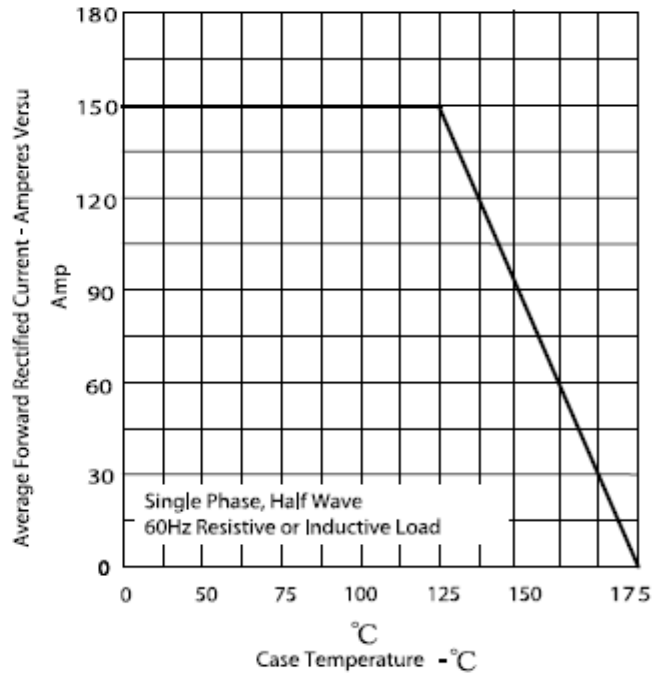

Figure.3- Peak Forward Surge Current

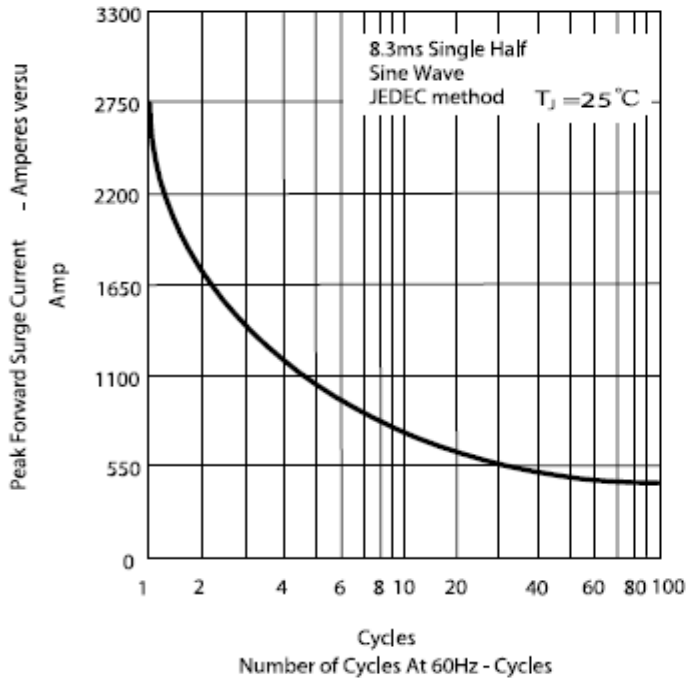
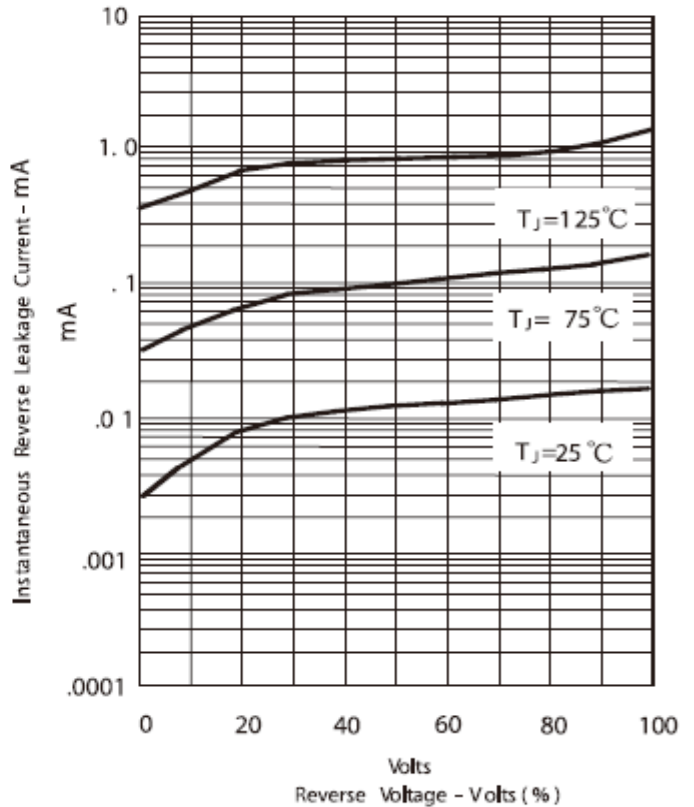
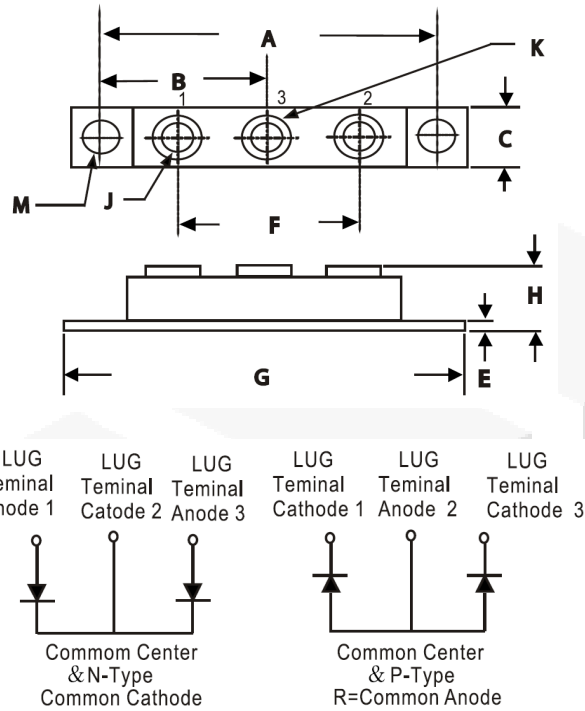

Figure .4-Typical Reverse Characteristics



Package dimensions and terminal configuration

Product is marked with part number and terminal configuration.



DIM	Inches		Millimeters	
	Min	Max	Min	Max
A	3.150	NOM	80.01	NOM
B	1.565	1.585	39.75	40.26
C	.700	.800	17.78	20.32
E	.119	.132	3.02	3.35
F	1.327	REF	33.72	REF
G	3.550	3.65	90.17	92.71
H	—	.73	—	18.30
J	1/4-20 UNC FULL			
K	.472	.511	12.00	13.00
M	.275	.295	6.99	7.49
N	2.380	2.46	60.50	62.50