

## Silicon Super Fast Recovery Diode

$V_{RRM} = 50\text{ V} - 200\text{ V}$

$I_F = 50\text{ A}$

### Features

- High Surge Capability
- Types from 50 V to 200 V  $V_{RRM}$
- Not ESD Sensitive

### Note:

1. Standard polarity: Stud is cathode.
2. Reverse polarity (R): Stud is anode.
3. Stud is base.

DO-5 Package

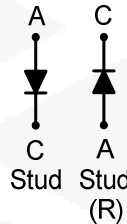

### Maximum ratings, at $T_j = 25\text{ }^\circ\text{C}$ , unless otherwise specified ("R" devices have leads reversed)

Parameter	Symbol	Conditions	MUR5005 (R)	MUR5010 (R)	MUR5020 (R)	Unit
Repetitive peak reverse voltage	$V_{RRM}$		50	100	200	V
RMS reverse voltage	$V_{RMS}$		35	70	140	V
DC blocking voltage	$V_{DC}$		50	100	200	V
Continuous forward current	$I_F$	$T_C \leq 125\text{ }^\circ\text{C}$	50	50	50	A
Surge non-repetitive forward current, Half Sine Wave	$I_{F,SM}$	$T_C = 25\text{ }^\circ\text{C}$ , $t_p = 8.3\text{ ms}$	600	600	600	A
Operating temperature	$T_j$		-55 to 150	-55 to 150	-55 to 150	$^\circ\text{C}$
Storage temperature	$T_{stg}$		-55 to 150	-55 to 150	-55 to 150	$^\circ\text{C}$

### Electrical characteristics, at $T_j = 25\text{ }^\circ\text{C}$ , unless otherwise specified

Parameter	Symbol	Conditions	MUR5005 (R)	MUR5010 (R)	MUR5020 (R)	Unit
Diode forward voltage	$V_F$	$I_F = 50\text{ A}$ , $T_j = 25\text{ }^\circ\text{C}$	1	1	1	V
Reverse current	$I_R$	$V_R = 50\text{ V}$ , $T_j = 25\text{ }^\circ\text{C}$	10	10	10	$\mu\text{A}$
		$V_R = 50\text{ V}$ , $T_j = 125\text{ }^\circ\text{C}$	3	3	3	mA

### Recovery Time

Maximum reverse recovery time	$T_{RR}$	$I_F = 0.5\text{ A}$ , $I_R = 1.0\text{ A}$ , $I_{RR} = 0.25\text{ A}$	75	75	75	ns
-------------------------------	----------	---	----	----	----	----

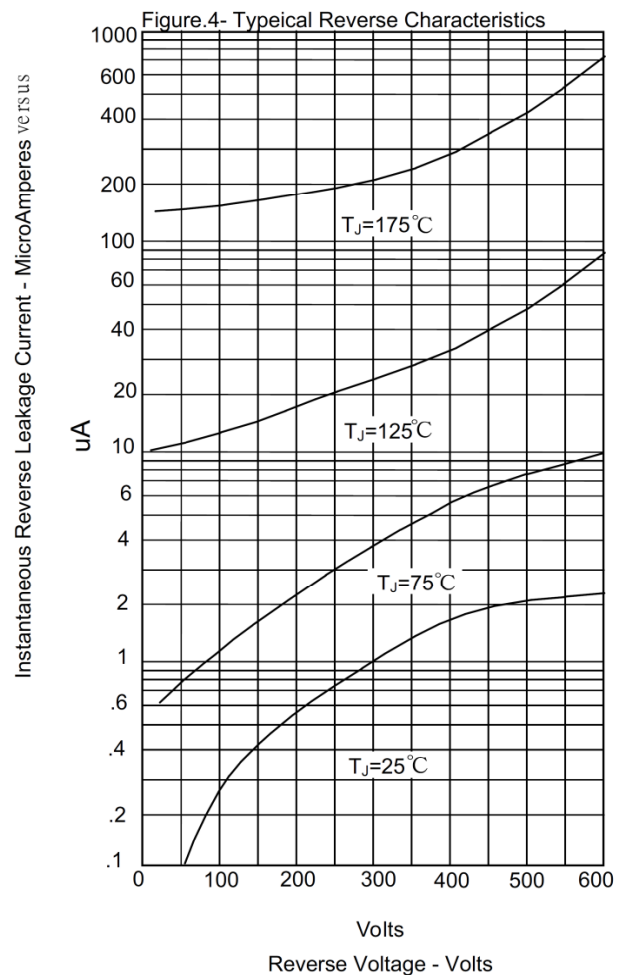
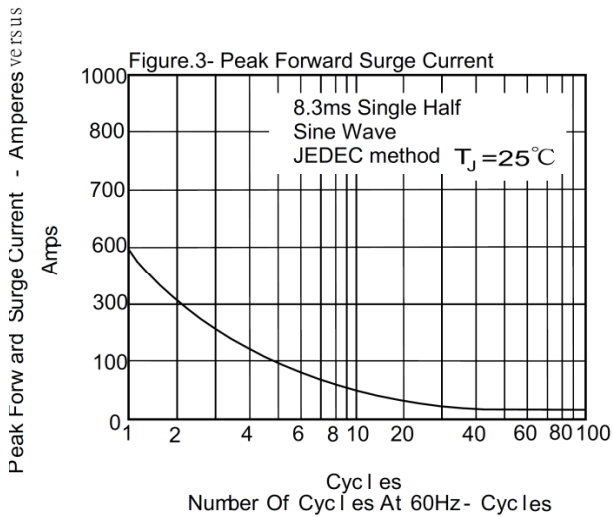
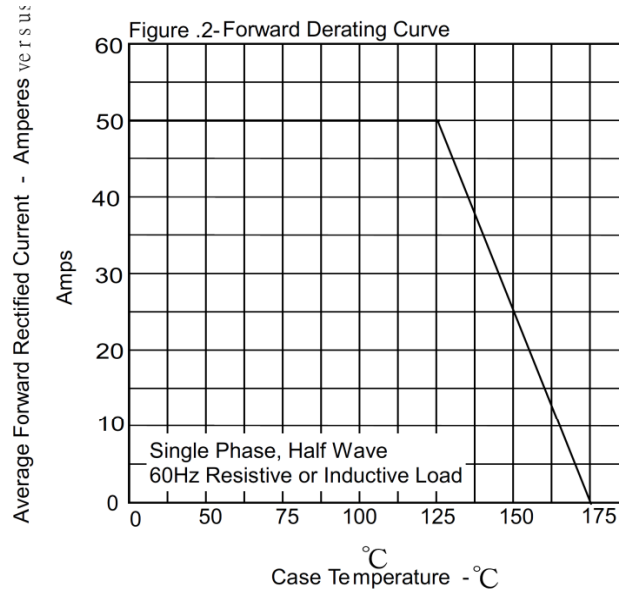
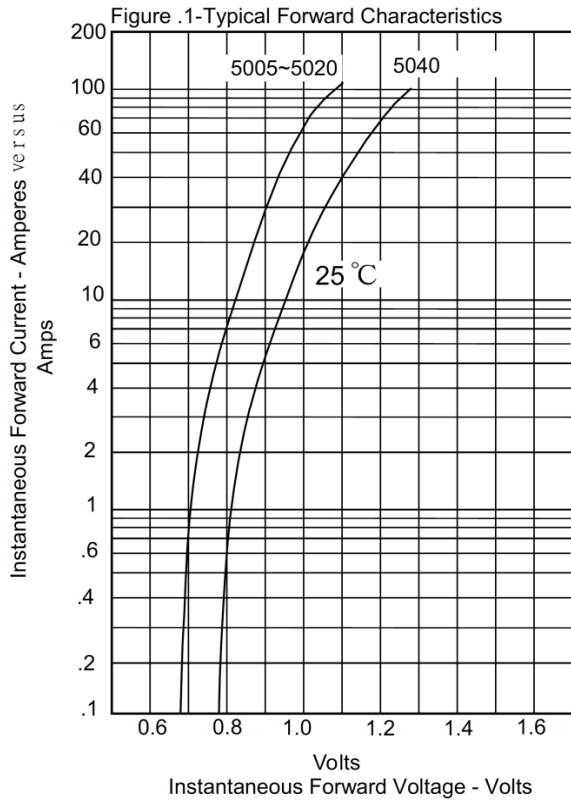

## Package dimensions and terminal configuration

Product is marked with part number and terminal configuration.

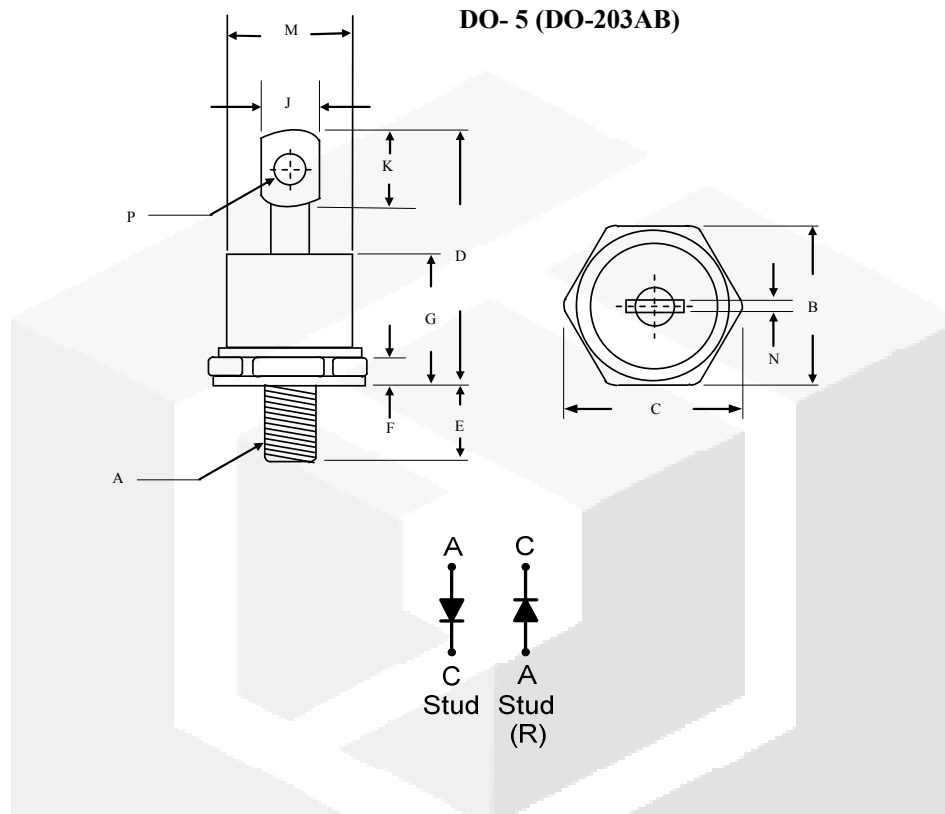

	Inches		Millimeters	
	Min	Max	Min	Max
A	1/4 -28 UNF			
B	0.669	0.687	17.19	17.44
C	----	0.794	----	20.16
D	----	1.020	----	25.91
E	0.422	0.453	10.72	11.50
F	0.115	0.200	2.93	5.08
G	----	0.460	----	11.68
J	----	0.280	----	7.00
K	0.236	----	6.00	----
M	----	0.589	----	14.96
N	----	0.063	----	1.60
P	0.140	0.175	3.56	4.45