

RF Power Field Effect Transistors

N-Channel Enhancement-Mode Lateral MOSFETs

Designed for CDMA base station applications with frequencies from 1805 MHz to 1995 MHz. Can be used in Class AB and Class C for all typical cellular base station modulation formats.

- Typical Single-Carrier W-CDMA Performance: $V_{DD} = 30$ Volts, $I_{DQ} = 1300$ mA, $P_{out} = 50$ Watts Avg., IQ Magnitude Clipping, Channel Bandwidth = 3.84 MHz, Input Signal PAR = 9.9 dB @ 0.01% Probability on CCDF.

Frequency	G_{ps} (dB)	η_D (%)	Output PAR (dB)	ACPR (dBc)
1930 MHz	17.8	29.2	7.0	-34.2
1960 MHz	17.8	28.2	7.0	-34.4
1995 MHz	18.1	27.6	7.1	-34.3

- Capable of Handling 10:1 VSWR, @ 32 Vdc, 1840 MHz, 268 Watts CW (1) Output Power (3 dB Input Overdrive from Rated P_{out})
- Typical P_{out} @ 1 dB Compression Point ≈ 210 Watts CW

1800 MHz

- Typical Single-Carrier W-CDMA Performance: $V_{DD} = 30$ Volts, $I_{DQ} = 1300$ mA, $P_{out} = 50$ Watts Avg., IQ Magnitude Clipping, Channel Bandwidth = 3.84 MHz, Input Signal PAR = 9.9 dB @ 0.01% Probability on CCDF.

Frequency	G_{ps} (dB)	η_D (%)	Output PAR (dB)	ACPR (dBc)
1805 MHz	18.2	30.1	7.3	-35.1
1840 MHz	18.1	29.1	7.4	-35.4
1880 MHz	18.2	27.8	7.4	-35.9

Features

- Designed for Wide Instantaneous Bandwidth Applications
- Designed for Wideband Applications that Require 40 MHz Signal Bandwidth
- 100% PAR Tested for Guaranteed Output Power Capability
- Characterized with Series Equivalent Large-Signal Impedance Parameters and Common Source S-Parameters
- Internally Matched for Ease of Use
- Integrated ESD Protection
- Greater Negative Gate-Source Voltage Range for Improved Class C Operation
- Designed for Digital Predistortion Error Correction Systems
- Optimized for Doherty Applications
- In Tape and Reel. R3 Suffix = 250 Units per 56 mm, 13 inch Reel. For R5 Tape and Reel option, see p. 17.

MRF8S18210WHSR3
MRF8S18210WGHSR3

1805 MHz - 1995 MHz
50 W AVG., 30 V
SINGLE W-CDMA
LATERAL N-CHANNEL
RF POWER MOSFETs

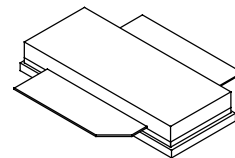

NI-880XS-2
MRF8S18210WHSR3

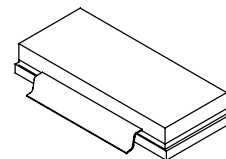

NI-880XS-2 GULL
MRF8S18210WGHSR3

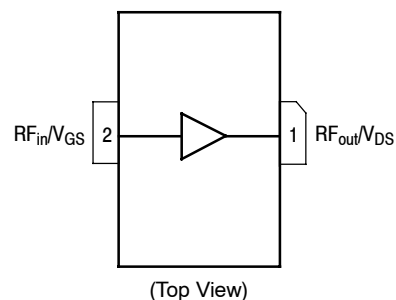

Figure 1. Pin Connections

Table 1. Maximum Ratings

Rating	Symbol	Value	Unit
Drain-Source Voltage	V_{DSS}	-0.5, +65	Vdc
Gate-Source Voltage	V_{GS}	-6.0, +10	Vdc
Operating Voltage	V_{DD}	32, +0	Vdc
Storage Temperature Range	T_{stg}	-65 to +150	$^{\circ}C$
Case Operating Temperature	T_C	125	$^{\circ}C$
Operating Junction Temperature (2,3)	T_J	225	$^{\circ}C$
CW Operation @ $T_C = 25^{\circ}C$	CW	239	W
Derate above $25^{\circ}C$		1.44	W/ $^{\circ}C$

1. Exceeds recommended operating conditions. See CW operation data in Maximum Ratings table.
2. Continuous use at maximum temperature will affect MTTF.
3. MTTF calculator available at <http://www.freescale.com/rf>. Select Software & Tools/Development Tools/Calculators to access MTTF calculators by product.

Table 2. Thermal Characteristics

Characteristic	Symbol	Value (1,2)	Unit
Thermal Resistance, Junction to Case Case Temperature 81°C, 50 W CW, 30 Vdc, I _{DQ} = 1300 mA, 1840 MHz Case Temperature 101°C, 210 W CW ⁽³⁾ , 30 Vdc, I _{DQ} = 1300 mA, 1840 MHz	R _{θJC}	0.48 0.44	°C/W

Table 3. ESD Protection Characteristics

Test Methodology	Class
Human Body Model (per JESD22-A114)	2
Machine Model (per EIA/JESD22-A115)	B
Charge Device Model (per JESD22-C101)	IV

Table 4. Electrical Characteristics (T_A = 25°C unless otherwise noted)

Characteristic	Symbol	Min	Typ	Max	Unit
----------------	--------	-----	-----	-----	------

Off Characteristics

Zero Gate Voltage Drain Leakage Current (V _{DS} = 65 Vdc, V _{GS} = 0 Vdc)	I _{DSS}	—	—	10	μAdc
Zero Gate Voltage Drain Leakage Current (V _{DS} = 30 Vdc, V _{GS} = 0 Vdc)	I _{DSS}	—	—	5	μAdc
Gate-Source Leakage Current (V _{GS} = 5 Vdc, V _{DS} = 0 Vdc)	I _{GSS}	—	—	1	μAdc

On Characteristics

Gate Threshold Voltage (V _{DS} = 10 Vdc, I _D = 306 μAdc)	V _{GS(th)}	1.2	1.9	2.7	Vdc
Gate Quiescent Voltage (V _{DD} = 30 Vdc, I _D = 1300 mAdc, Measured in Functional Test)	V _{GS(Q)}	2.0	2.7	3.5	Vdc
Drain-Source On-Voltage (V _{GS} = 10 Vdc, I _D = 3.06 Adc)	V _{DS(on)}	0.1	0.24	0.3	Vdc

Functional Tests ^(4,5) (In Freescale Test Fixture, 50 ohm system) V_{DD} = 30 Vdc, I_{DQ} = 1300 mA, P_{out} = 50 W Avg., f = 1930 MHz, Single-Carrier W-CDMA, IQ Magnitude Clipping, Input Signal PAR = 9.9 dB @ 0.01% Probability on CCDF. ACPR measured in 3.84 MHz Channel Bandwidth @ ±5 MHz Offset.

Power Gain	G _{ps}	17.0	17.8	20.0	dB
Drain Efficiency	η _D	26.0	29.2	—	%
Output Peak-to-Average Ratio @ 0.01% Probability on CCDF	PAR	6.7	7.0	—	dB
Adjacent Channel Power Ratio	ACPR	—	-34.2	-30.0	dBc
Input Return Loss	IRL	—	-9	-7	dB

Typical Broadband Performance (In Freescale Test Fixture, 50 ohm system) V_{DD} = 30 Vdc, I_{DQ} = 1300 mA, P_{out} = 50 W Avg., Single-Carrier W-CDMA, IQ Magnitude Clipping, Input Signal PAR = 9.9 dB @ 0.01% Probability on CCDF. ACPR measured in 3.84 MHz Channel Bandwidth @ ±5 MHz Offset.

Frequency	G _{ps} (dB)	η _D (%)	Output PAR (dB)	ACPR (dBc)	IRL (dB)
1930 MHz	17.8	29.2	7.0	-34.2	-9
1960 MHz	17.8	28.2	7.0	-34.4	-9
1995 MHz	18.1	27.6	7.1	-34.3	-13

1. MTTF calculator available at <http://www.freescale.com/rf>. Select Software & Tools/Development Tools/Calculators to access MTTF calculators by product.
2. Refer to AN1955, *Thermal Measurement Methodology of RF Power Amplifiers*. Go to <http://www.freescale.com/rf>. Select Documentation/Application Notes - AN1955.
3. Exceeds recommended operating conditions. See CW operation data in Maximum Ratings table.
4. Part internally matched both on input and output.
5. Measurement made with device in straight lead configuration before any lead forming operation is applied.

(continued)

Table 4. Electrical Characteristics ($T_A = 25^\circ\text{C}$ unless otherwise noted) (continued)

Characteristic	Symbol	Min	Typ	Max	Unit
Typical Performance (In Freescale Test Fixture, 50 ohm system) $V_{DD} = 30\text{ Vdc}$, $I_{DQ} = 1300\text{ mA}$, 1930 MHz - 1995 MHz Bandwidth					
P_{out} @ 1 dB Compression Point, CW	P1dB	—	210	—	W
IMD Symmetry @ 80 W PEP, P_{out} where IMD Third Order Intermodulation $\cong 30\text{ dBc}$ (Delta IMD Third Order Intermodulation between Upper and Lower Sidebands > 2 dB)	IMD _{sym}	—	12	—	MHz
VBW Resonance Point (IMD Third Order Intermodulation Inflection Point)	VBW _{res}	—	100	—	MHz
Gain Flatness in 65 MHz Bandwidth @ $P_{out} = 50\text{ W Avg.}$	G _F	—	0.14	—	dB
Gain Variation over Temperature (-30°C to $+85^\circ\text{C}$)	ΔG	—	0.02	—	dB/ $^\circ\text{C}$
Output Power Variation over Temperature (-30°C to $+85^\circ\text{C}$) (1)	$\Delta P1\text{dB}$	—	0.008	—	dB/ $^\circ\text{C}$

Typical Broadband Performance — 1800 MHz (In Freescale 1800 MHz Test Fixture, 50 ohm system) $V_{DD} = 30\text{ Vdc}$, $I_{DQ} = 1300\text{ mA}$, $P_{out} = 50\text{ W Avg.}$, Single-Carrier W-CDMA, IQ Magnitude Clipping, Input Signal PAR = 9.9 dB @ 0.01% Probability on CCDF. ACPR measured in 3.84 MHz Channel Bandwidth @ $\pm 5\text{ MHz}$ Offset.

Frequency	G _{ps} (dB)	η_D (%)	Output PAR (dB)	ACPR (dBc)	IRL (dB)
1805 MHz	18.2	30.1	7.3	-35.1	-10
1840 MHz	18.1	29.1	7.4	-35.4	-9
1880 MHz	18.2	27.8	7.4	-35.9	-10

1. Exceeds recommended operating conditions. See CW operation data in Maximum Ratings table.

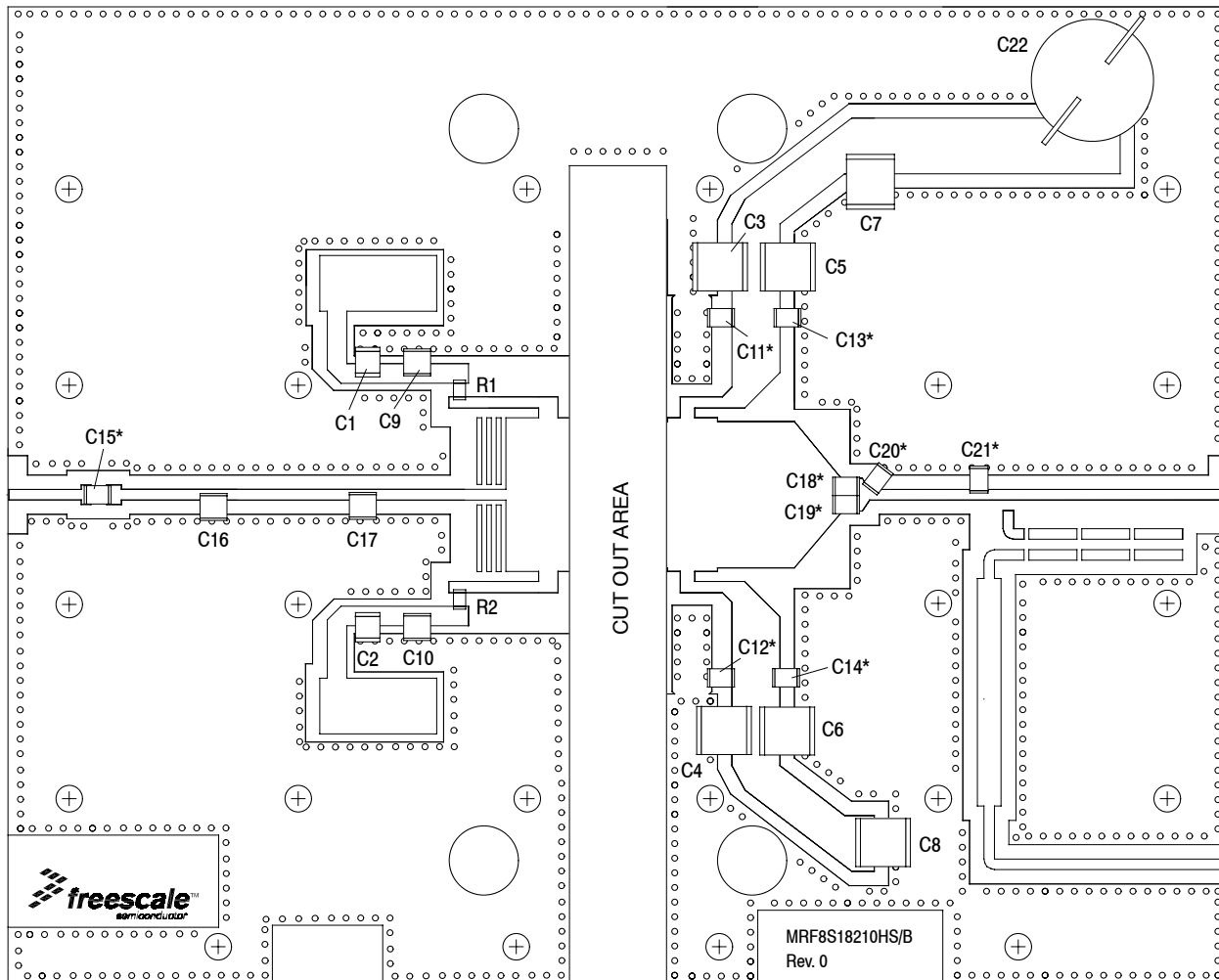

*C11, C12, C13, C14, C15, C18, C19, C20, and C21 are mounted vertically.

Figure 2. MRF8S18210WHSR3(WGHSR3) Test Circuit Component Layout

Table 5. MRF8S18210WHSR3(WGHSR3) Test Circuit Component Designations and Values

Part	Description	Part Number	Manufacturer
C1, C2	2.2 μ F Chip Capacitors	C3225X7R2A225M	TDK
C3, C4, C5, C6, C7, C8	10 μ F Chip Capacitors	C5750X7S2A106MT	TDK
C9, C10, C11, C12, C13, C14	8.2 pF Chip Capacitors	ATC100B8R2BT500XT	ATC
C15	1.3 pF Chip Capacitor	ATC100B1R3BT500XT	ATC
C16, C21	1.8 pF Chip Capacitors	ATC100B1R8BT500XT	ATC
C17	2.0 pF Chip Capacitor	ATC100B2R0BT500XT	ATC
C18, C19	3.9 pF Chip Capacitors	ATC100B3R9BT500XT	ATC
C20	1.0 pF Chip Capacitor	ATC100B1R0BT500XT	ATC
C22	470 μ F, 63 V Electrolytic Capacitor	B41858-C8477-M000	EPCOS
R1, R2	10 Ω , 1/4 W Chip Resistors	232272461009	Phycomp
PCB	0.020", $\epsilon_r = 3.5$	RO4350B	Rogers

TYPICAL CHARACTERISTICS

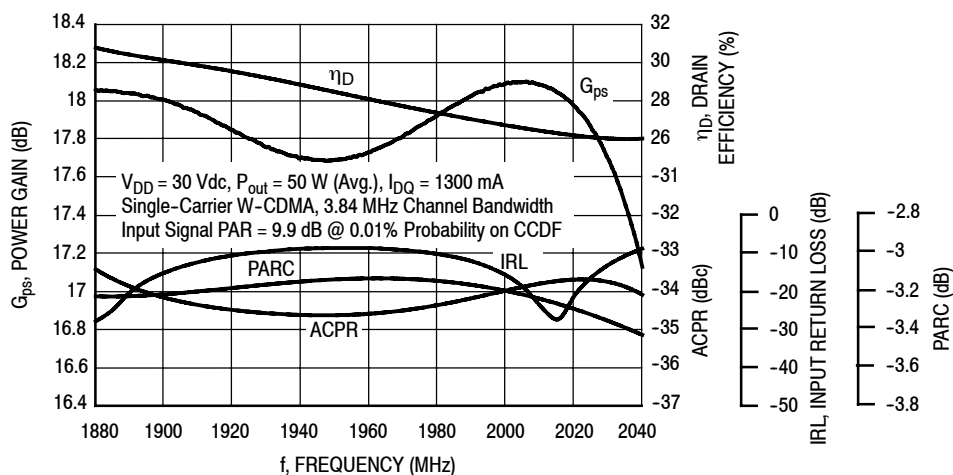

Figure 3. Output Peak-to-Average Ratio Compression (PARC) Broadband Performance @ $P_{out} = 50$ Watts Avg.

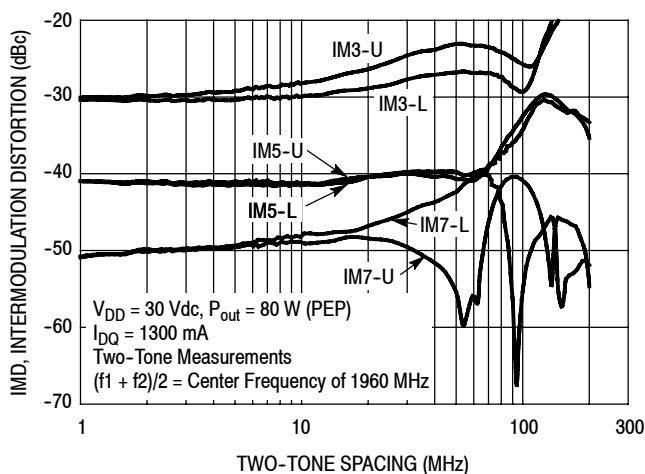

Figure 4. Intermodulation Distortion Products versus Two-Tone Spacing

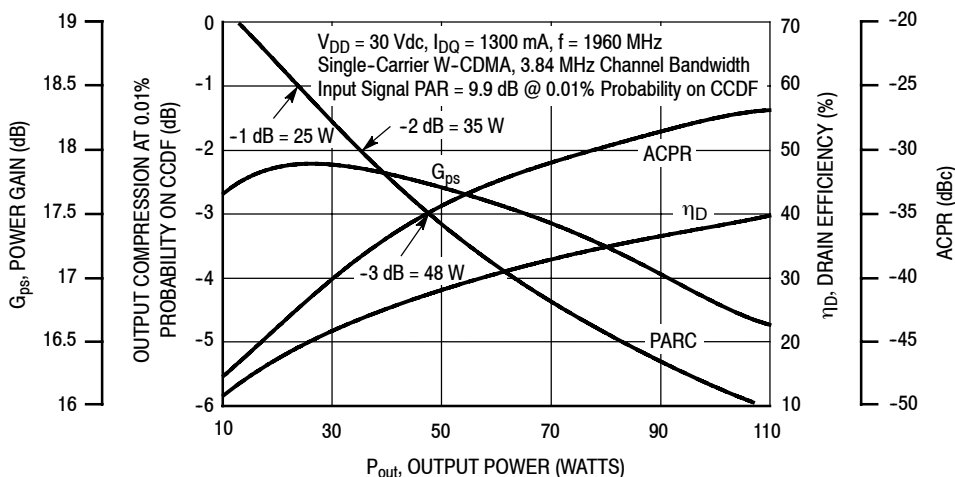

Figure 5. Output Peak-to-Average Ratio Compression (PARC) versus Output Power

TYPICAL CHARACTERISTICS

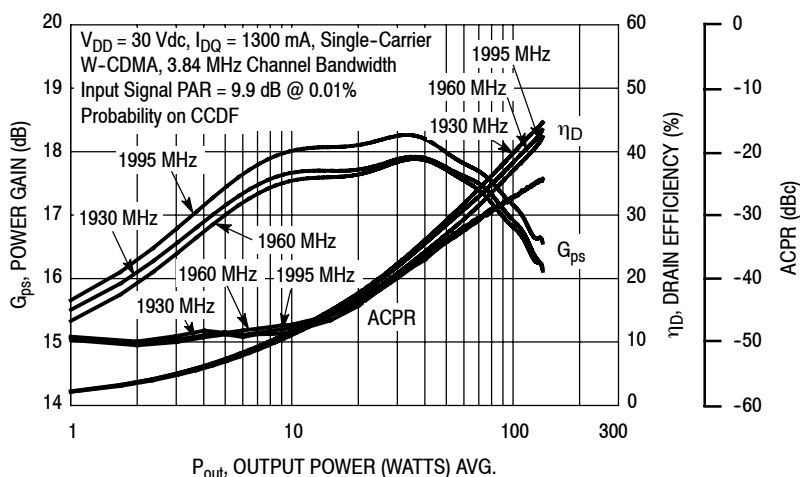

Figure 6. Single-Carrier W-CDMA Power Gain, Drain Efficiency and ACPR versus Output Power

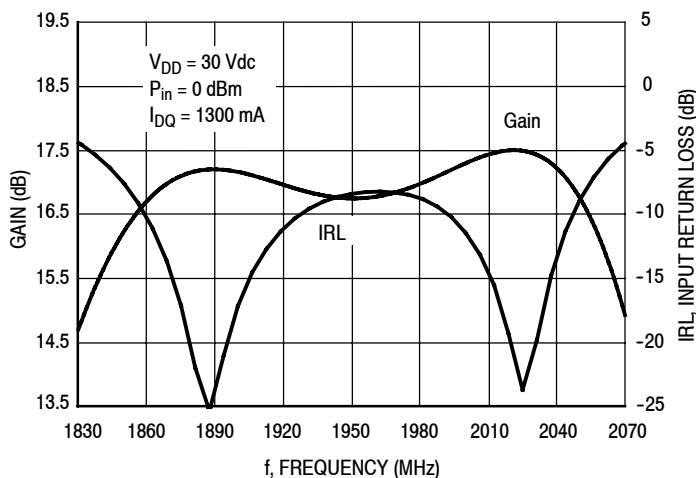

Figure 7. Broadband Frequency Response

W-CDMA TEST SIGNAL

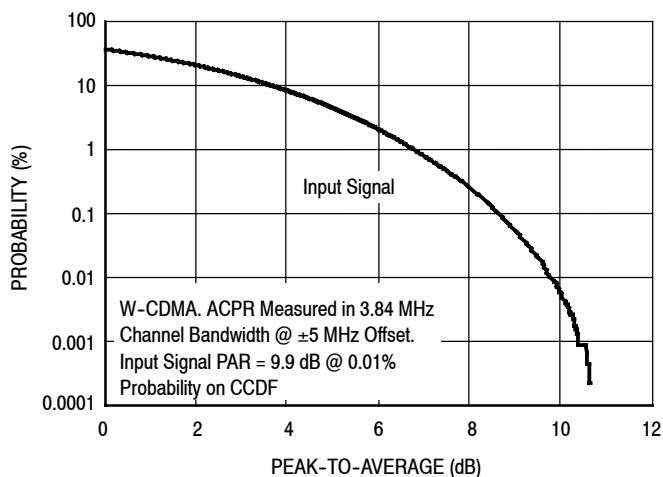

Figure 8. CCDF W-CDMA IQ Magnitude Clipping, Single-Carrier Test Signal

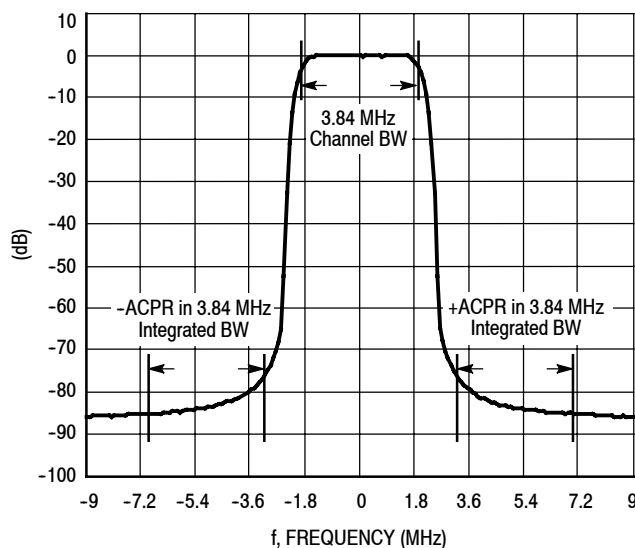

Figure 9. Single-Carrier W-CDMA Spectrum

$V_{DD} = 30 \text{ Vdc}$, $I_{DQ} = 1300 \text{ mA}$, $P_{out} = 50 \text{ W Avg.}$

f MHz	Z_{source} Ω	Z_{load} Ω
1880	$3.52 - j5.54$	$3.50 - j2.60$
1900	$3.71 - j4.76$	$3.42 - j2.64$
1920	$3.97 - j3.96$	$3.33 - j2.67$
1940	$4.31 - j3.15$	$3.23 - j2.69$
1960	$4.76 - j2.29$	$3.13 - j2.71$
1980	$5.33 - j1.40$	$3.02 - j2.71$
2000	$6.08 - j0.48$	$2.89 - j2.71$
2020	$7.08 + j0.47$	$2.77 - j2.71$
2040	$8.39 + j1.41$	$2.64 - j2.69$

Z_{source} = Test circuit impedance as measured from gate to ground.

Z_{load} = Test circuit impedance as measured from drain to ground.

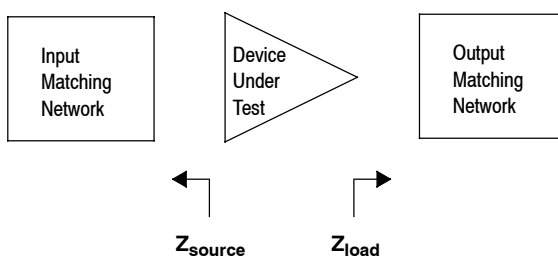

Figure 10. Series Equivalent Source and Load Impedance

$V_{DD} = 30 \text{ Vdc}$, $I_{DQ} = 1300 \text{ mA}$, Pulsed CW, $10 \mu\text{sec}(\text{on})$, 10% Duty Cycle

f (MHz)	Z_{source} (Ω)	$Z_{\text{load}}^{(1)}$ (Ω)	Max Output Power					
			P1dB			P3dB		
			(dBm)	(W)	η_D (%)	(dBm)	(W)	η_D (%)
1930	5.06 - j7.33	2.07 - j3.37	54.3	269	49.2	55.2	331	51.2
1960	10.2 - j6.91	2.14 - j3.42	54.2	263	48.7	55.1	324	50.8
1995	13.1 - j0.18	2.39 - j3.53	54.1	257	48.5	55.0	316	49.7

(1) Load impedance for optimum P1dB power.

Z_{source} = Impedance as measured from gate contact to ground.

Z_{load} = Impedance as measured from drain contact to ground.

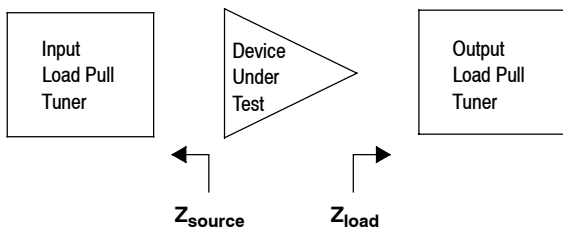

Figure 11. Load Pull Performance — Maximum P1dB Tuning

$V_{DD} = 30 \text{ Vdc}$, $I_{DQ} = 1300 \text{ mA}$, Pulsed CW, $10 \mu\text{sec}(\text{on})$, 10% Duty Cycle

f (MHz)	Z_{source} (Ω)	$Z_{\text{load}}^{(1)}$ (Ω)	Max Drain Efficiency					
			P1dB			P3dB		
			(dBm)	(W)	η_D (%)	(dBm)	(W)	η_D (%)
1930	5.06 - j7.33	2.44 - j1.46	52.7	186	58.9	53.4	219	61.4
1960	10.2 - j6.91	2.23 - j1.55	52.6	182	57.8	53.5	224	60.3
1995	13.1 - j0.18	2.31 - j1.63	52.6	182	56.6	53.3	214	59.8

(1) Load impedance for optimum P1dB efficiency.

Z_{source} = Impedance as measured from gate contact to ground.

Z_{load} = Impedance as measured from drain contact to ground.

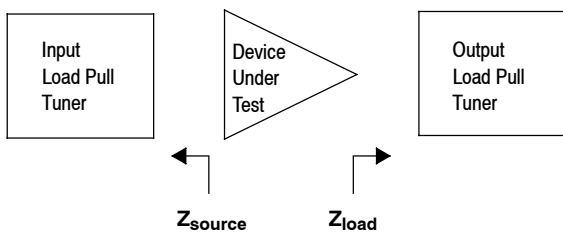
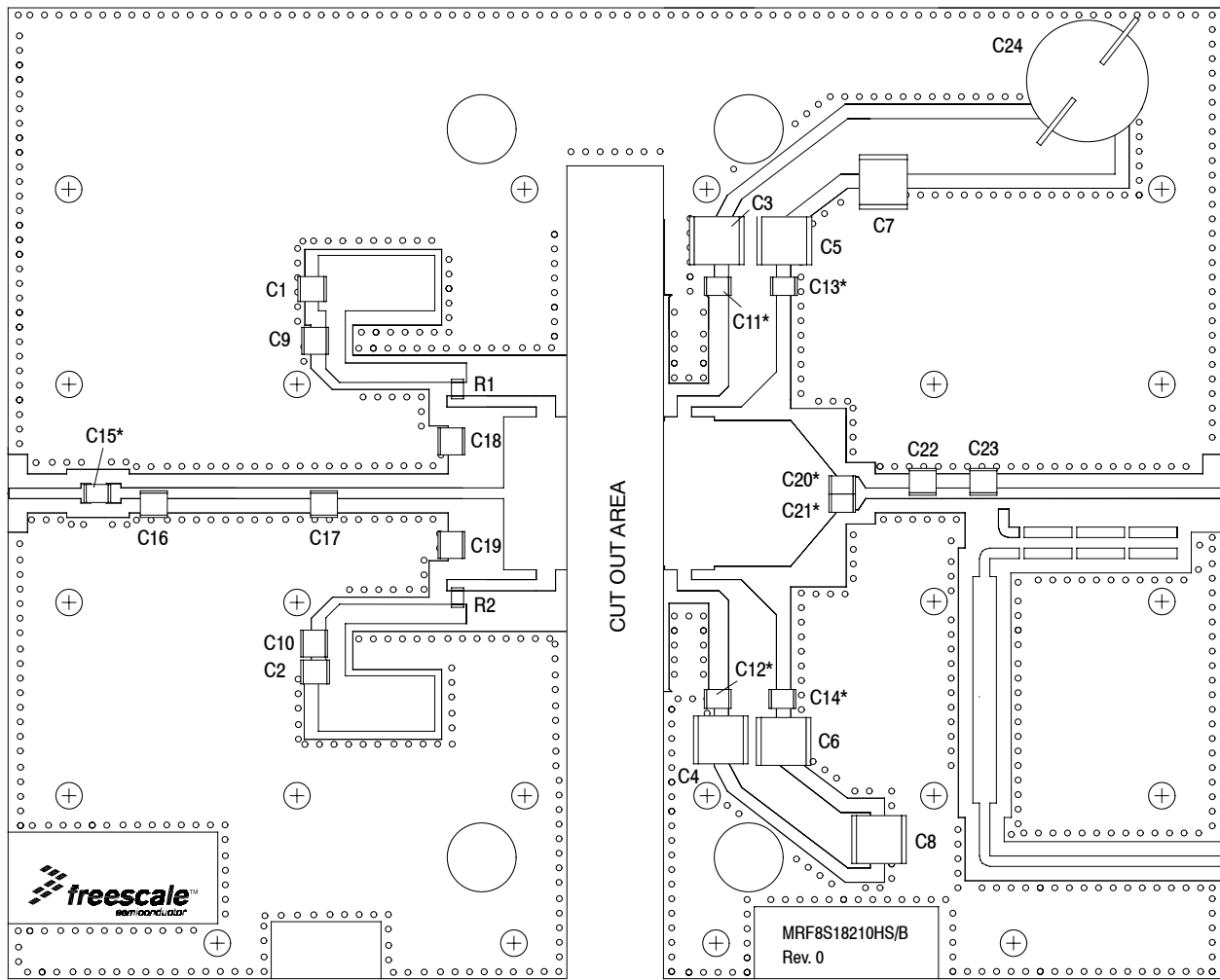

Figure 12. Load Pull Performance — Maximum Drain Efficiency Tuning



*C11, C12, C13, C14, C15, C20, and C21 are mounted vertically.

Figure 13. MRF8S18210WHSR3(WGHSR3) Test Circuit Component Layout — 1805 MHz - 1880 MHz

Table 6. MRF8S18210WHSR3(WGHSR3) Test Circuit Component Designations and Values — 1805 MHz - 1880 MHz

Part	Description	Part Number	Manufacturer
C1, C2	2.2 μ F Chip Capacitors	C3225X7R2A225M	TDK
C3, C4, C5, C6, C7, C8	10 μ F Chip Capacitors	C5750X7S2A106MT	TDK
C9, C10, C11, C12, C13, C14	8.2 pF Chip Capacitors	ATC100B8R2BT500XT	ATC
C15	10 pF Chip Capacitor	ATC100B10R0BT500XT	ATC
C16, C17	2.2 pF Chip Capacitors	ATC100B2R2BT500XT	ATC
C18, C19, C22	0.8 pF Chip Capacitors	ATC100B0R8BT500XT	ATC
C20, C21	3.9 pF Chip Capacitors	ATC100B3R9BT500XT	ATC
C23	1.8 pF Chip Capacitor	ATC100B1R8BT500XT	ATC
C24	470 μ F, 63 V Electrolytic Capacitor	B41858-C8477-M000	EPCOS
R1, R2	10 Ω , 1/4 W Chip Resistors	232272461009	Phycomp
PCB	0.020", $\epsilon_r = 3.5$	RO4350B	Rogers

TYPICAL CHARACTERISTICS — 1805 MHz - 1880 MHz

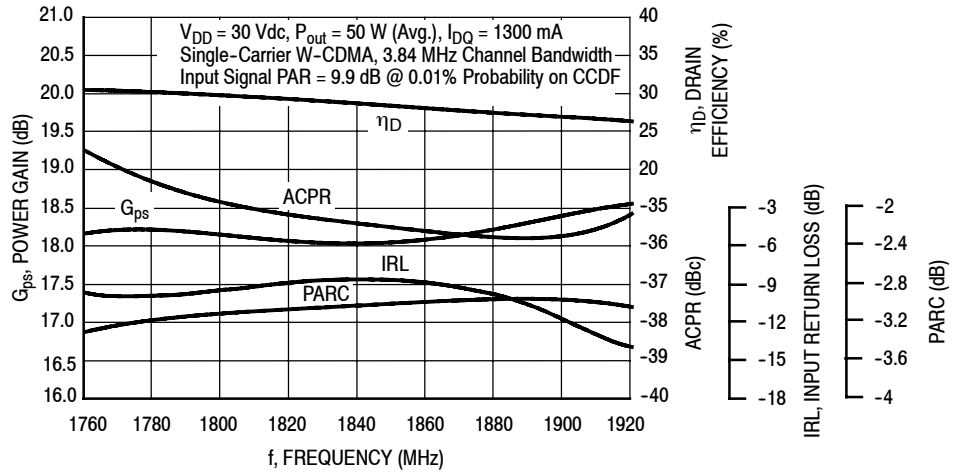

Figure 14. Output Peak-to-Average Ratio Compression (PARC) Broadband Performance @ $P_{out} = 50$ Watts Avg.

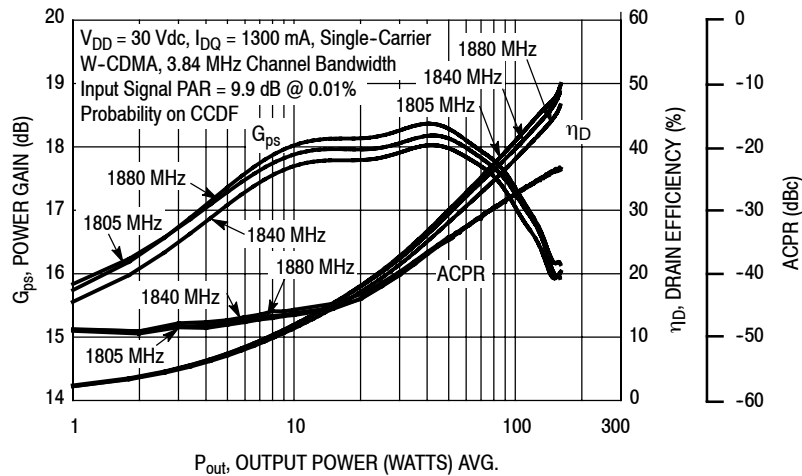

Figure 15. Single-Carrier W-CDMA Power Gain, Drain Efficiency and ACPR versus Output Power

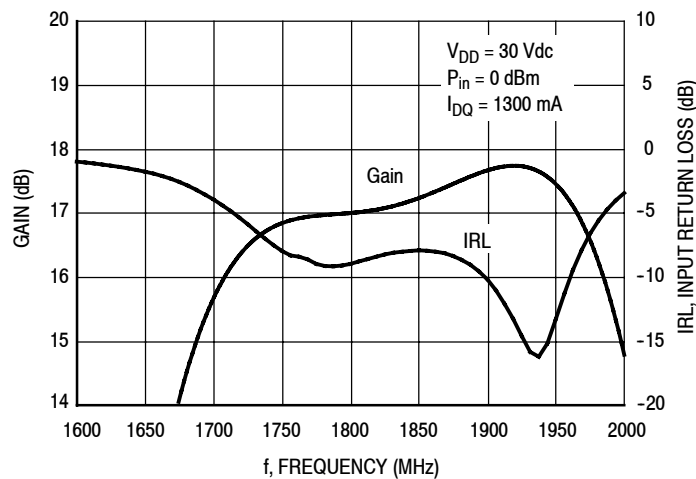

Figure 16. Broadband Frequency Response

$V_{DD} = 30 \text{ Vdc}$, $I_{DQ} = 1300 \text{ mA}$, $P_{out} = 50 \text{ W Avg.}$

f MHz	Z_{source} Ω	Z_{load} Ω
1760	1.81 - j4.25	3.09 - j2.28
1780	1.95 - j4.06	2.97 - j2.29
1800	2.13 - j3.89	2.85 - j2.29
1820	2.35 - j3.77	2.71 - j2.28
1840	2.61 - j3.70	2.58 - j2.25
1860	2.91 - j3.74	2.45 - j2.21
1880	3.19 - j3.90	2.32 - j2.16
1900	3.41 - j4.21	2.19 - j2.10
1920	3.48 - j4.64	2.06 - j2.03

Z_{source} = Test circuit impedance as measured from gate to ground.

Z_{load} = Test circuit impedance as measured from drain to ground.

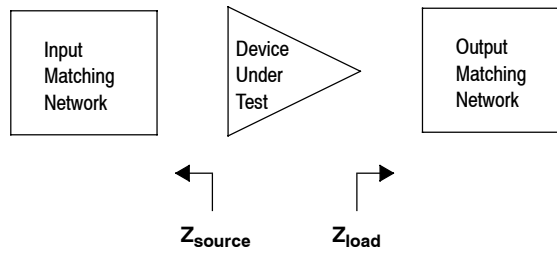

Figure 17. Series Equivalent Source and Load Impedance — 1805 MHz - 1880 MHz

$V_{DD} = 30 \text{ Vdc}$, $I_{DQ} = 1300 \text{ mA}$, Pulsed CW, $10 \mu\text{sec}(\text{on})$, 10% Duty Cycle

f (MHz)	Z_{source} (Ω)	$Z_{\text{load}}^{(1)}$ (Ω)	Max Output Power					
			P1dB			P3dB		
			(dBm)	(W)	η_D (%)	(dBm)	(W)	η_D (%)
1805	0.79 - j4.26	1.77 - j2.83	54.4	275	50.5	55.3	339	52.0
1840	1.34 - j5.03	1.83 - j2.96	54.5	282	50.8	55.3	339	52.2
1880	2.15 - j5.84	1.89 - j2.98	54.4	275	51.0	55.3	339	51.8

(1) Load impedance for optimum P1dB power.

Z_{source} = Impedance as measured from gate contact to ground.

Z_{load} = Impedance as measured from drain contact to ground.

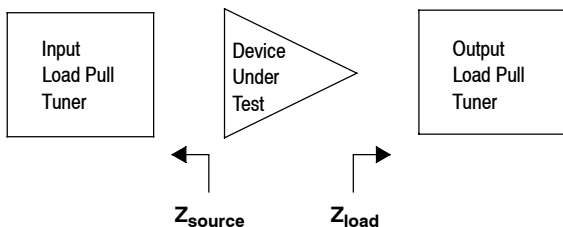

Figure 18. Load Pull Performance — Maximum P1dB Tuning — 1805 MHz - 1880 MHz

$V_{DD} = 30 \text{ Vdc}$, $I_{DQ} = 1300 \text{ mA}$, Pulsed CW, $10 \mu\text{sec}(\text{on})$, 10% Duty Cycle

f (MHz)	Z_{source} (Ω)	$Z_{\text{load}}^{(1)}$ (Ω)	Max Drain Efficiency					
			P1dB			P3dB		
			(dBm)	(W)	η_D (%)	(dBm)	(W)	η_D (%)
1805	0.79 - j4.26	3.02 - j1.55	53.0	200	59.6	53.4	219	62.5
1840	1.34 - j5.03	2.64 - j1.20	52.8	191	60.7	53.5	224	63.0
1880	2.15 - j5.84	2.40 - j1.51	53.1	204	59.7	53.2	209	62.2

(1) Load impedance for optimum P1dB efficiency.

Z_{source} = Impedance as measured from gate contact to ground.

Z_{load} = Impedance as measured from drain contact to ground.

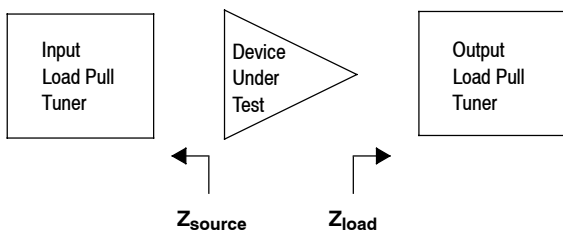
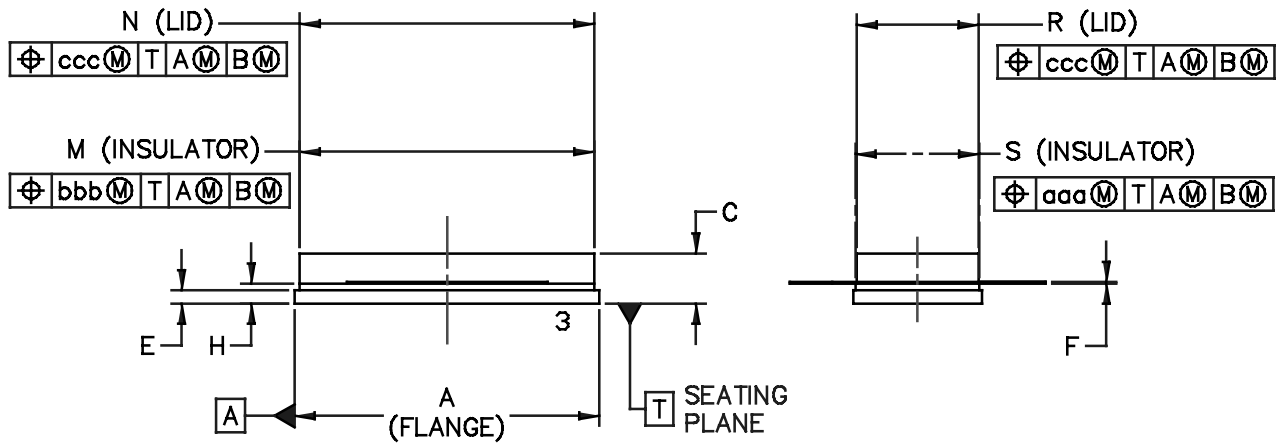
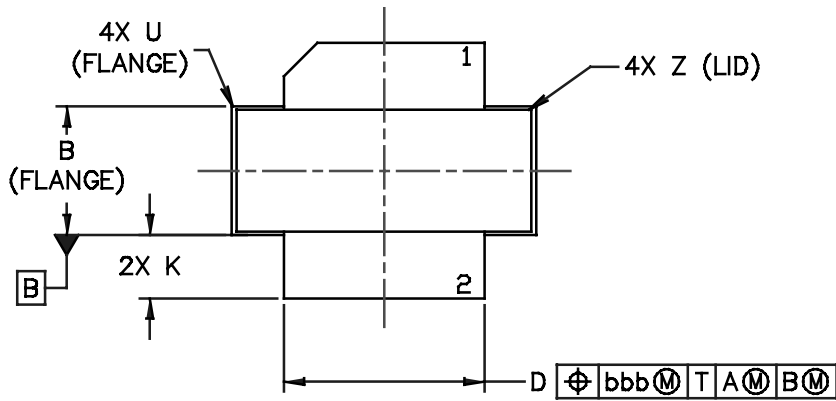

Figure 19. Load Pull Performance — Maximum Drain Efficiency Tuning — 1805 MHz - 1880 MHz

PACKAGE DIMENSIONS



© FREESCALE SEMICONDUCTOR, INC. ALL RIGHTS RESERVED.	MECHANICAL OUTLINE		PRINT VERSION NOT TO SCALE	
	TITLE: NI-880XS		DOCUMENT NO: 98ASA00325D	REV: 0
			CASE NUMBER: 2194-01	10 MAY 2011
STANDARD: NON-JEDEC				

NOTES:

1. DIMENSIONING AND TOLERANCING PER ANSI Y14.5M–1994.
2. CONTROLLING DIMENSION: INCH.
3. DIMENSION H IS MEASURED .030 (0.762) AWAY FROM PACKAGE BODY.

DIM	INCH		MILLIMETER		DIM	INCH		MILLIMETER	
	MIN	MAX	MIN	MAX		MIN	MAX	MIN	MAX
A	.905	– .915	22.99	– 23.24	U	–	– .040	–	– 1.02
B	.380	– .390	9.65	– 9.91	Z	–	– .030	–	– 0.76
C	.125	– .170	3.18	– 4.32	aaa	–	.005 –	–	0.127 –
D	.595	– .605	15.11	– 15.37	bbb	–	.010 –	–	0.254 –
E	.035	– .045	0.89	– 1.14	ccc	–	.015 –	–	0.381 –
F	.003	– .006	0.08	– 0.15	–	–	– –	–	– –
H	.057	– .067	1.45	– 1.70	–	–	– –	–	– –
K	.170	– .210	4.32	– 5.33	–	–	– –	–	– –
M	.872	– .888	22.15	– 22.56	–	–	– –	–	– –
N	.871	– .889	22.12	– 22.58	–	–	– –	–	– –
R	.365	– .375	9.27	– 9.53	–	–	– –	–	– –
S	.365	– .375	9.27	– 9.53	–	–	– –	–	– –

© FREESCALE SEMICONDUCTOR, INC. ALL RIGHTS RESERVED.	MECHANICAL OUTLINE	PRINT VERSION NOT TO SCALE
TITLE: NI–880XS	DOCUMENT NO: 98ASA00325D CASE NUMBER: 2194–01 STANDARD: NON–JEDEC	REV: 0 10 MAY 2011

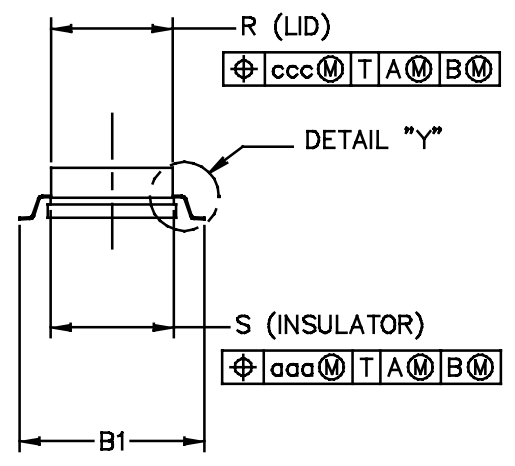
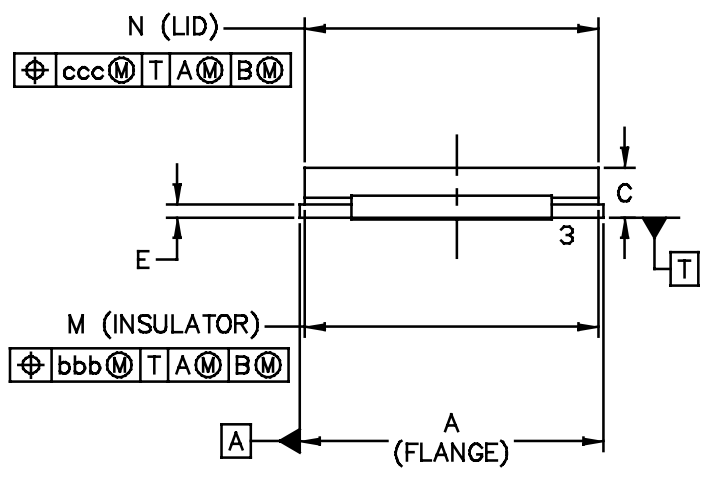
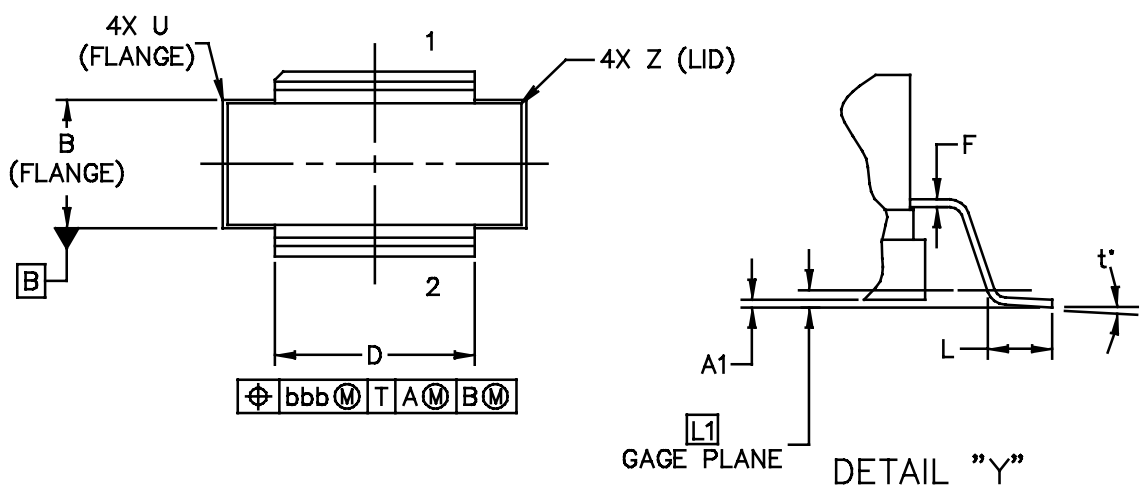

© FREESCALE SEMICONDUCTOR, INC. ALL RIGHTS RESERVED.	MECHANICAL OUTLINE	PRINT VERSION NOT TO SCALE	
	TITLE: NI-880XS-2 GULL	DOCUMENT NO: 98ASA00456D CASE NUMBER: 2279-01 STANDARD: NON-JEDEC	REV: 0 23 FEB 2012

NOTES:

1. DIMENSIONING AND TOLERANCING PER ANSI Y14.5M-1994.
2. CONTROLLING DIMENSION: INCH.
3. DIMENSION A1 IS MEASURED WITH REFERENCE TO DATUM T. THE POSITIVE VALUE IMPLIES THAT THE PACKAGE BOTTOM IS HIGHER THAN THE LEAD BOTTOM.

DIM	INCH		MILLIMETER		DIM	INCH		MILLIMETER	
	MIN	MAX	MIN	MAX		MIN	MAX	MIN	MAX
A	.905	-.915	22.99	- 23.24	U	R.000	- R.040	R0.00	- R1.02
A1	.000	-.010	0.00	- 0.25	Z	-	- .030	-	- 0.76
B	.380	-.390	9.65	- 9.91	t'	0'	- 8'	0'	- 8'
B1	.549	-.559	13.94	- 14.20					
C	.125	-.170	3.18	- 4.32					
D	.595	-.605	15.11	- 15.37	aaa	-	.005 -	-	0.127 -
E	.035	-.045	0.89	- 1.14	bbb	-	.010 -	-	0.254 -
F	.003	-.006	0.08	- 0.15	ccc	-	.015 -	-	0.381 -
L	.038	-.046	0.97	- 1.17	-	-	- -	-	- -
L1	.01 BSC		0.25 BSC		-	-	- -	-	- -
M	.872	-.888	22.15	- 22.56	-	-	- -	-	- -
N	.871	-.889	22.12	- 22.58	-	-	- -	-	- -
R	.365	-.375	9.27	- 9.53					
S	.365	-.375	9.27	- 9.53					
© FREESCALE SEMICONDUCTOR, INC. ALL RIGHTS RESERVED.			MECHANICAL OUTLINE			PRINT VERSION NOT TO SCALE			
TITLE: NI-880XS-2 GULL					DOCUMENT NO: 98ASA00456D			REV: 0	
					CASE NUMBER: 2279-01			23 FEB 2012	
					STANDARD: NON-JEDEC				

Refer to the following documents, software and tools to aid your design process.

Application Notes

- AN1955: Thermal Measurement Methodology of RF Power Amplifiers

Engineering Bulletins

- EB212: Using Data Sheet Impedances for RF LDMOS Devices

Software

- Electromigration MTTF Calculator
- RF High Power Model
- .s2p File

Development Tools

- Printed Circuit Boards

For Software and Tools, do a Part Number search at <http://www.freescale.com>, and select the “Part Number” link. Go to the Software & Tools tab on the part’s Product Summary page to download the respective tool.

R5 TAPE AND REEL OPTION

R5 Suffix = 50 Units, 56 mm Tape Width, 13 inch Reel.

The R5 tape and reel option for MRF8S18210WHS and MRF8S18210WGHS parts will be available for 2 years after release of MRF8S18210WHS and MRF8S18210WGHS. Freescale Semiconductor, Inc. reserves the right to limit the quantities that will be delivered in the R5 tape and reel option. At the end of the 2 year period customers who have purchased these devices in the R5 tape and reel option will be offered MRF8S18210WHS and MRF8S18210WGHS in the R3 tape and reel option.

REVISION HISTORY

The following table summarizes revisions to this document.

Revision	Date	Description
0	Apr. 2012	• Initial Release of Data Sheet

How to Reach Us:

Home Page:
freescale.com

Web Support:
freescale.com/support

Information in this document is provided solely to enable system and software implementers to use Freescale products. There are no express or implied copyright licenses granted hereunder to design or fabricate any integrated circuits based on the information in this document.

Freescale reserves the right to make changes without further notice to any products herein. Freescale makes no warranty, representation, or guarantee regarding the suitability of its products for any particular purpose, nor does Freescale assume any liability arising out of the application or use of any product or circuit, and specifically disclaims any and all liability, including without limitation consequential or incidental damages. "Typical" parameters that may be provided in Freescale data sheets and/or specifications can and do vary in different applications, and actual performance may vary over time. All operating parameters, including "typicals," must be validated for each customer application by customer's technical experts. Freescale does not convey any license under its patent rights nor the rights of others. Freescale sells products pursuant to standard terms and conditions of sale, which can be found at the following address: <http://www.reg.net/v2/webservices/Freescale/Docs/TermsandConditions.htm>.

Freescale, the Freescale logo, Altivec, C-5, CodeTest, CodeWarrior, ColdFire, C-Ware, Energy Efficient Solutions logo, Kinetis, mobileGT, PowerQUICC, Processor Expert, QorIQ, Qorivva, StarCore, Symphony, and VortiQa are trademarks of Freescale Semiconductor, Inc., Reg. U.S. Pat. & Tm. Off. Airfast, BeeKit, BeeStack, ColdFire+, CoreNet, Flexis, MagniV, MXC, Platform in a Package, QorIQ Qonverge, QUICC Engine, Ready Play, SafeAssure, SMARTMOS, TurboLink, Vybrid, and Xtrinsic are trademarks of Freescale Semiconductor, Inc. All other product or service names are the property of their respective owners.

© 2012 Freescale Semiconductor, Inc.