

Designed primarily for wideband large-signal output and driver from 30–500MHz.

N-Channel enhancement mode MOSFET

- MRF166C — Guaranteed performance at 500 MHz, 28 Vdc  
Output power = 20 W  
Gain = 13.5 dB  
Efficiency = 50%
- Replacement for industry standards such as MRF136, V2820, BLF244, SD1902, and ST1001
- 100% tested for load mismatch at all phase angles with 30:1 VSWR
- Facilitates manual gain control, ALC and modulation techniques
- Excellent thermal stability, ideally suited for Class A operation
- Low Crss — 4.0 pF @ VDS = 28 V

## Product Image

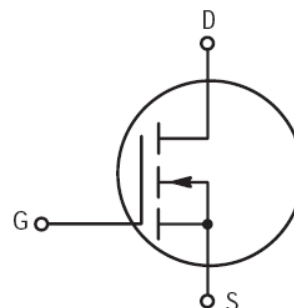
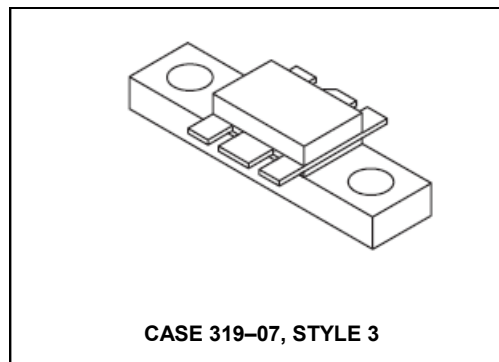

## MAXIMUM RATINGS

Rating	Symbol	Value	Unit
Drain–Gate Voltage	$V_{DSS}$	65	Vdc
Drain–Gate Voltage ( $R_{GS} = 1.0 \text{ M}\Omega$ )	$V_{DGR}$	65	Vdc
Gate–Source Voltage	$V_{GS}$	$\pm 20$	Adc
Drain Current — Continuous	$I_D$	4.0	Adc
Total Device Dissipation @ $T_C = 25^\circ\text{C}$ Derate Above $25^\circ\text{C}$	$P_D$	70 0.4	Watts W/ $^\circ\text{C}$
Storage Temperature Range	$T_{stg}$	–65 to 150	$^\circ\text{C}$
Operating Junction Temperature	$T_J$	200	$^\circ\text{C}$

## THERMAL CHARACTERISTICS

Characteristic	Symbol	Max	Unit
Thermal Resistance, Junction to Case	$R_{\theta JC}$	2.5	$^\circ\text{C}/\text{W}$

NOTE — **CAUTION** — MOS devices are susceptible to damage from electrostatic charge. Reasonable precautions in handling and packaging MOS devices should be observed.

**ELECTRICAL CHARACTERISTICS** ( $T_C = 25^\circ\text{C}$  unless otherwise noted)

Characteristic	Symbol	Min	Typ	Max	Unit
----------------	--------	-----	-----	-----	------

**OFF CHARACTERISTICS**

Drain-Source Breakdown Voltage ( $V_{GS} = 0\text{ V}, I_D = 5.0\text{ mA}$ )	$V_{(BR)DSS}$	65	—	—	V
Zero Gate Voltage Drain Current ( $V_{DS} = 28\text{ V}, V_{GS} = 0\text{ V}$ )	$I_{DSS}$	—	—	0.5	mA
Gate-Source Leakage Current ( $V_{GS} = 20\text{ V}, V_{DS} = 0\text{ V}$ )	$I_{GSS}$	—	—	1.0	$\mu\text{A}$

**ON CHARACTERISTICS**

Gate Threshold Voltage ( $V_{DS} = 10\text{ V}, I_D = 25\text{ mA}$ )	$V_{GS(th)}$	1.5	3.0	4.5	V
Forward Transconductance ( $V_{DS} = 10\text{ V}, I_D = 1.5\text{ A}$ )	$g_{fs}$	0.8	1.1	—	mhos

**DYNAMIC CHARACTERISTICS**

Input Capacitance ( $V_{DS} = 28\text{ V}, V_{GS} = 0\text{ V}, f = 1.0\text{ MHz}$ )	$C_{iss}$	—	28	—	pF
Output Capacitance ( $V_{DS} = 28\text{ V}, V_{GS} = 0\text{ V}, f = 1.0\text{ MHz}$ )	$C_{oss}$	—	30	—	pF
Reverse Transfer Capacitance ( $V_{DS} = 28\text{ V}, V_{GS} = 0\text{ V}, f = 1.0\text{ MHz}$ )	$C_{rss}$	—	4.0	—	pF

**FUNCTIONAL CHARACTERISTICS**

Common Source Power Gain ( $V_{DD} = 28\text{ V}, P_{out} = 20\text{ W}, f = 500\text{ MHz}, I_{DQ} = 25\text{ mA}$ )	$G_{ps}$	13.5	16	—	dB
Drain Efficiency ( $V_{DD} = 28\text{ V}, P_{out} = 20\text{ W}, f = 500\text{ MHz}, I_{DQ} = 25\text{ mA}$ )	$\eta$	50	55	—	%
Electrical Ruggedness ( $V_{DD} = 28\text{ V}, P_{out} = 20\text{ W}, f = 500\text{ MHz}, I_{DQ} = 25\text{ mA}$ , Load VSWR 30:1 at All Phase Angles)	$\psi$	No Degradation in Output Power			

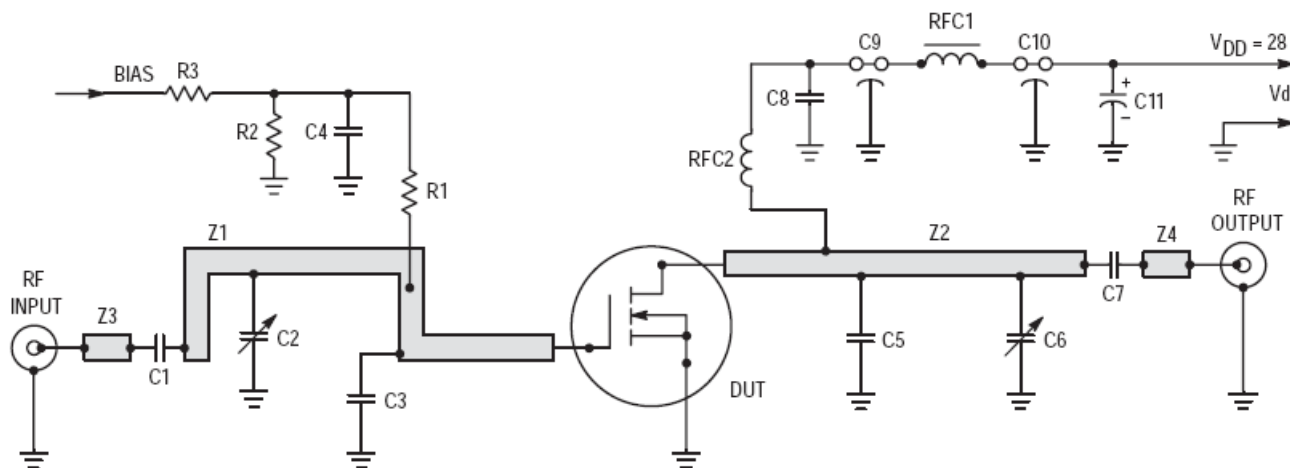

- C1, C7 200 pF, Chip Capacitor
- C2, C6 2–10 pF, Trimmer Capacitor, Johansen
- C3 27 pF, ATC 100 mil Chip Capacitor
- C4, C8 0.1  $\mu$ F, Chip Capacitor
- C5 15 pF, ATC 100 mil Chip Capacitor
- C9, C10 680 pF, Feedthru Capacitor
- C11 50  $\mu$ F, 50 V, Electrolytic Capacitor
- R1 120  $\Omega$ , 1/2 W Resistor
- R2 10 k $\Omega$ , 1/2 W Resistor
- R3 1 k $\Omega$ , 1/2 W Resistor
- RFC1 Ferroxcube VK200 19/4B
- RFC2 10 Turns AWG #18, 0.125" I.D., Enameled
- Board Material 0.062" Teflon<sup>®</sup> Fiberglass  
1 oz. Copper Clad Both Sides  
 $\epsilon_r = 2.56$

Z1 0.120" x 3.3", Microstrip Line

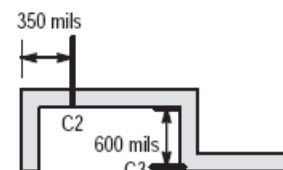

Z2 0.120" x 2.1", Microstrip Line

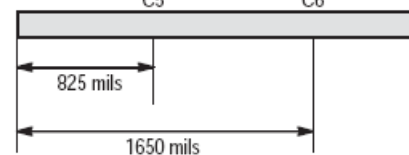

Z3, Z4 0.120" x 0.25", Microstrip Line

Figure 1. MRF166C 500 MHz Test Circuit

## TYPICAL CHARACTERISTICS

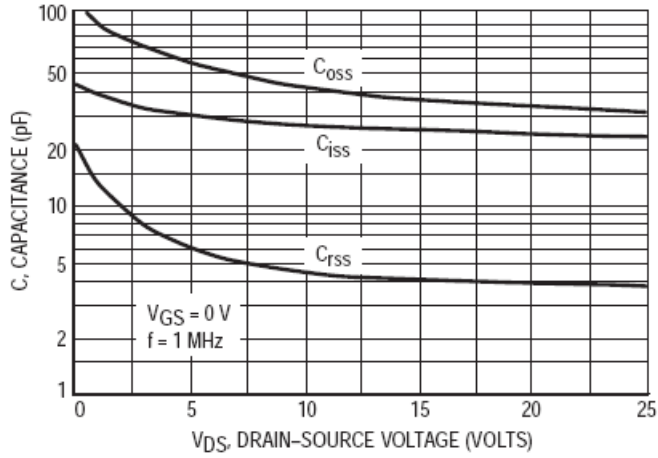

Figure 2. Capacitance versus Drain-Source Voltage

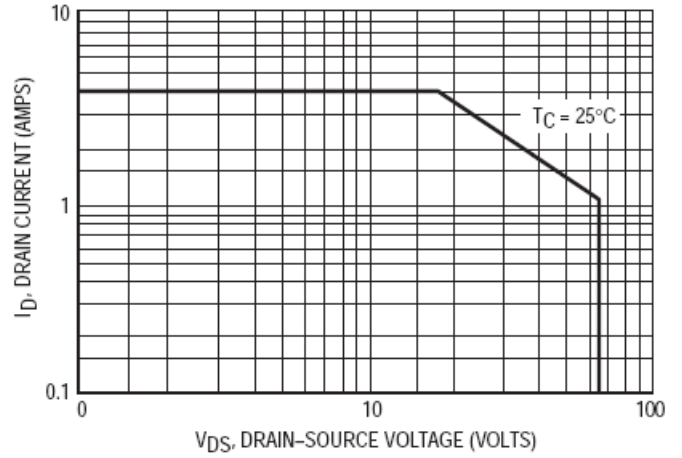

Figure 3. DC Safe Operating Area

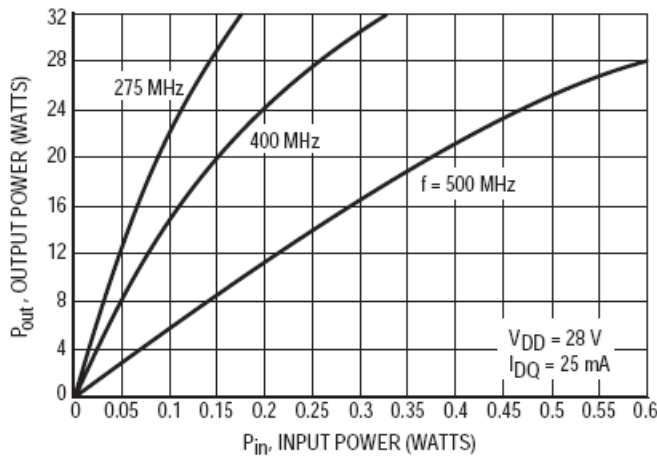

Figure 4. Output Power versus Input Power

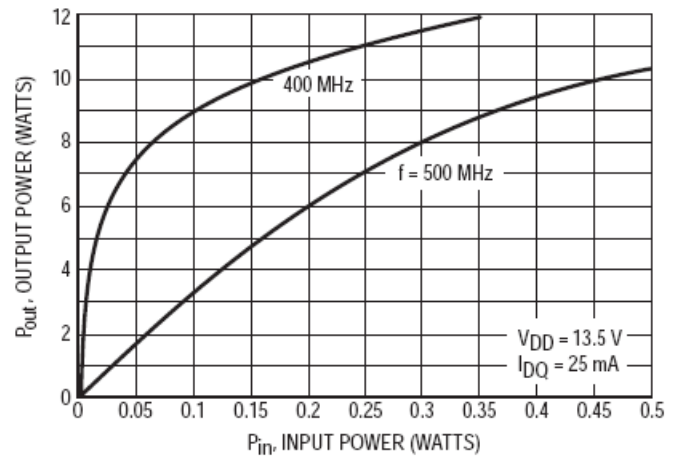

Figure 5. Output Power versus Input Power

## TYPICAL CHARACTERISTICS

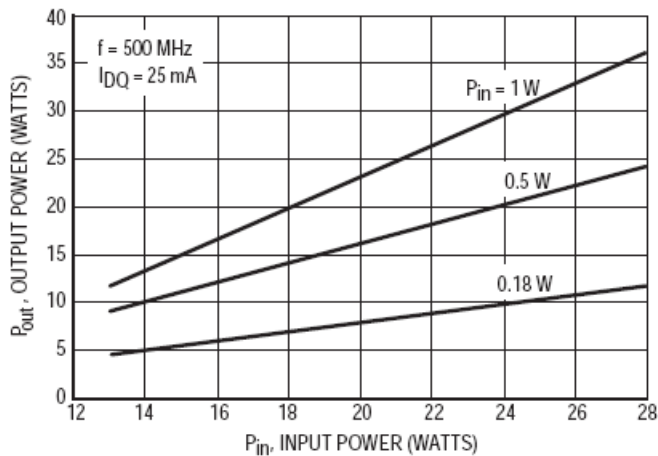

Figure 6. Output Power versus Supply Voltage

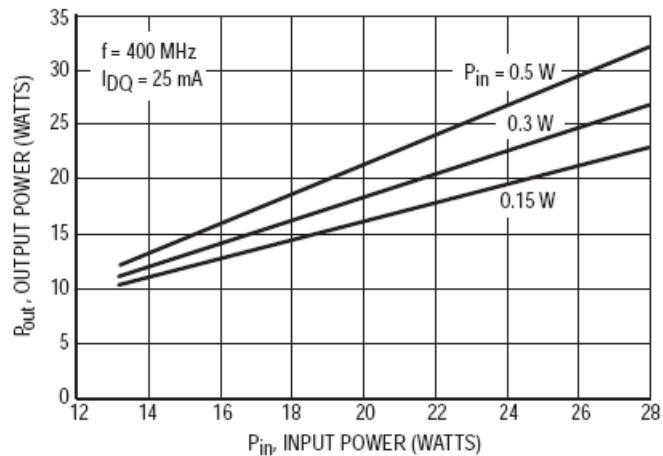
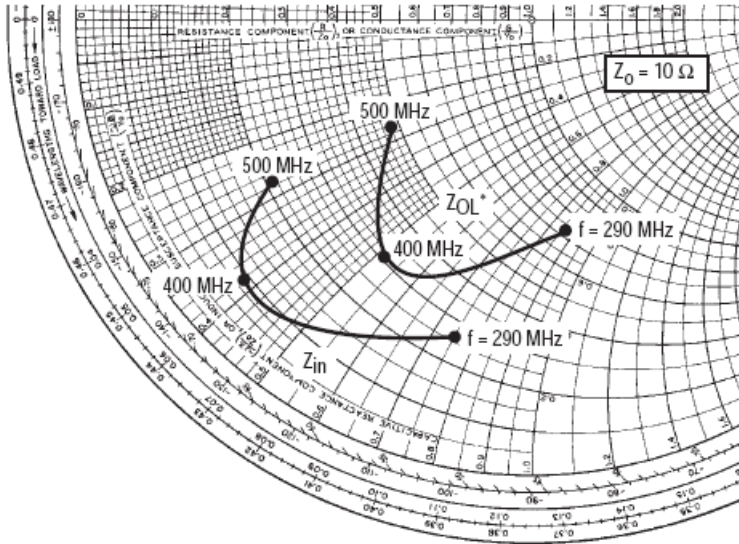

Figure 7. Output Power versus Supply Voltage



$V_{DD} = 28\text{ V}$ ,  $I_{DQ} = 25\text{ mA}$ ,  $P_{out} = 20\text{ Watts}$

f MHz	$Z_{in}$ Ohms	$Z_{OL}^*$ Ohms
500	$2.09 - j2.77$	$4.87 - j2.63$
400	$0.93 - j3.80$	$3.09 - j5.24$
290	$2.63 - j7.58$	$7.35 - j8.67$

$Z_{OL}^*$  = Conjugate of the optimum load impedance into which the device output operates at a given output power, voltage and frequency.

Figure 8. Series Equivalent Input and Output Impedance

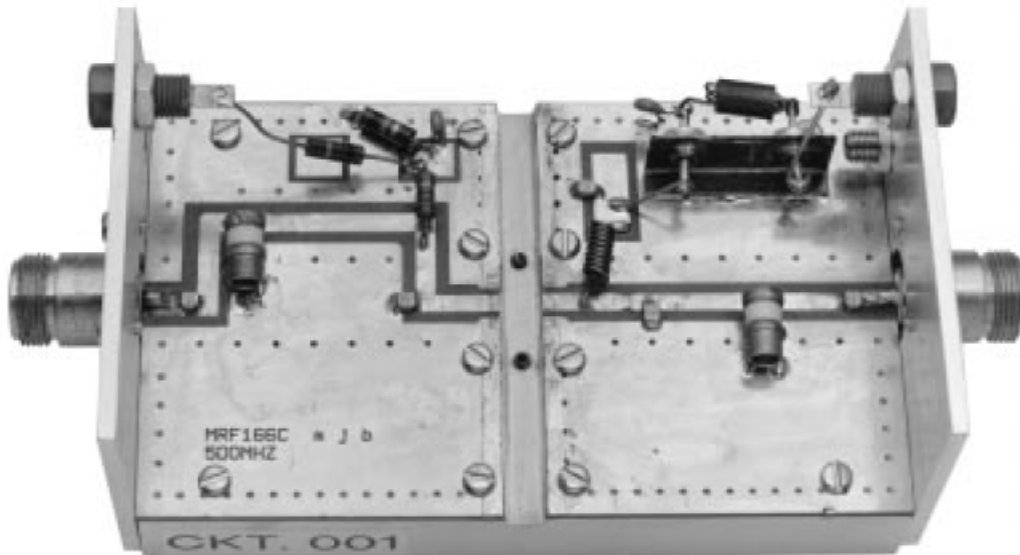

Figure 9. MRF166C Test Fixture

Table 1. Common Source S-Parameters ( $V_{DS} = 12.5\text{ V}$ ,  $I_D = 1.25\text{ A}$ )

f MHz	S <sub>11</sub>		S <sub>21</sub>		S <sub>12</sub>		S <sub>22</sub>	
	S <sub>11</sub>	φ	S <sub>21</sub>	φ	S <sub>12</sub>	φ	S <sub>22</sub>	φ
30	0.840	-142	22.59	105	0.025	20	0.727	-155
40	0.836	-151	17.4	100	0.025	17	0.743	-161
50	0.832	-156	14.1	97	0.026	15	0.751	-164
60	0.829	-159	12.0	94	0.026	14	0.764	-166
70	0.826	-162	10.4	91	0.026	14	0.763	-168
80	0.822	-164	9.09	90	0.026	14	0.763	-169
90	0.818	-165	8.07	89	0.027	14	0.765	-170
100	0.819	-167	7.28	87	0.027	14	0.774	-171
110	0.821	-168	6.61	85	0.027	14	0.773	-172
120	0.821	-169	6.00	83	0.026	15	0.771	-172
130	0.820	-169	5.56	83	0.027	16	0.778	-172
140	0.818	-170	5.22	82	0.027	17	0.785	-172
150	0.820	-170	4.86	80	0.027	17	0.786	-173
160	0.821	-171	4.52	79	0.027	17	0.781	-173
170	0.820	-171	4.23	79	0.027	20	0.774	-172
180	0.820	-171	4.03	78	0.027	20	0.799	-173
190	0.820	-172	3.86	76	0.027	20	0.799	-174
200	0.821	-172	3.62	75	0.027	20	0.784	-175
210	0.822	-173	3.39	75	0.027	22	0.780	-174
220	0.823	-173	3.25	74	0.027	24	0.795	-173
230	0.825	-173	3.12	72	0.028	23	0.823	-175
240	0.827	-173	2.96	71	0.026	24	0.791	-175
250	0.827	-174	2.83	70	0.027	26	0.789	-174
260	0.827	-174	2.71	70	0.026	27	0.791	-174
270	0.829	-174	2.62	69	0.027	28	0.801	-174
280	0.831	-174	2.52	68	0.027	29	0.807	-175
290	0.832	-174	2.42	66	0.027	30	0.788	-175
300	0.832	-174	2.32	66	0.027	32	0.792	-175
310	0.831	-174	2.25	66	0.027	33	0.797	-174
320	0.833	-175	2.18	65	0.027	34	0.810	-174
330	0.836	-175	2.10	63	0.028	35	0.812	-175
340	0.837	-175	2.00	62	0.027	35	0.789	-176
350	0.838	-175	1.95	62	0.028	39	0.806	-173
360	0.839	-175	1.90	61	0.028	39	0.817	-174
370	0.840	-176	1.84	60	0.028	40	0.817	-175
380	0.843	-176	1.77	59	0.028	41	0.811	-175
390	0.845	-176	1.71	59	0.028	42	0.805	-175
400	0.846	-176	1.66	58	0.029	46	0.801	-172
410	0.846	-176	1.64	57	0.030	46	0.845	-174
420	0.847	-176	1.59	56	0.030	46	0.836	-176
430	0.848	-176	1.52	56	0.030	47	0.823	-176
440	0.850	-176	1.48	56	0.030	49	0.816	-174

Table 1. Common Source S-Parameters ( $V_{DS} = 12.5\text{ V}$ ,  $I_D = 1.25\text{ A}$ ) (continued)

f MHz	S <sub>11</sub>		S <sub>21</sub>		S <sub>12</sub>		S <sub>22</sub>	
	S <sub>11</sub>	φ	S <sub>21</sub>	φ	S <sub>12</sub>	φ	S <sub>22</sub>	φ
450	0.851	-176	1.47	54	0.032	51	0.851	-174
460	0.853	-177	1.42	53	0.032	48	0.849	-178
470	0.853	-177	1.37	53	0.031	51	0.830	-176
480	0.856	-177	1.34	53	0.032	53	0.834	-176
490	0.857	-177	1.32	52	0.033	54	0.841	-175
500	0.859	-177	1.28	51	0.034	54	0.847	-175
600	0.857	178	0.988	41	0.032	73	0.877	180
700	0.884	176	0.789	34	0.047	65	0.881	179
800	0.881	173	0.684	30	0.031	83	0.890	174
900	0.890	172	0.580	26	0.069	71	0.885	176
1000	0.897	170	0.503	24	0.090	60	0.931	173



Table 2. Common Source S-Parameters ( $V_{DS} = 28\text{ V}$ ,  $I_D = 1.25\text{ A}$ )

f MHz	S <sub>11</sub>		S <sub>21</sub>		S <sub>12</sub>		S <sub>22</sub>	
	S <sub>11</sub>	∠	S <sub>21</sub>	∠	S <sub>12</sub>	∠	S <sub>22</sub>	∠
30	0.842	-125	29.6	113	0.024	28	0.586	-136
40	0.831	-136	23.2	106	0.025	22	0.607	-145
50	0.822	-143	19.0	101	0.026	19	0.613	-151
60	0.816	-148	16.2	98	0.026	17	0.626	-155
70	0.812	-152	14.1	95	0.027	16	0.635	-157
80	0.806	-155	12.4	92	0.026	15	0.643	-159
90	0.801	-157	11.1	90	0.027	14	0.650	-160
100	0.802	-159	9.97	88	0.027	13	0.656	-161
110	0.805	-161	9.04	86	0.027	13	0.654	-163
120	0.805	-162	8.22	84	0.026	13	0.654	-163
130	0.803	-163	7.59	83	0.026	14	0.663	-163
140	0.801	-164	7.09	82	0.026	14	0.673	-164
150	0.803	-165	6.61	80	0.026	14	0.675	-164
160	0.804	-165	6.16	79	0.026	14	0.674	-164
170	0.803	-166	5.77	78	0.026	16	0.672	-164
180	0.804	-166	5.49	77	0.026	17	0.697	-164
190	0.806	-166	5.25	75	0.026	16	0.700	-165
200	0.806	-167	4.92	73	0.025	16	0.688	-166
210	0.807	-168	4.60	73	0.025	17	0.680	-165
220	0.809	-168	4.40	72	0.025	19	0.689	-165
230	0.812	-168	4.21	70	0.025	19	0.713	-167
240	0.814	-169	3.99	69	0.024	20	0.701	-167
250	0.815	-169	3.83	68	0.024	21	0.707	-166
260	0.816	-169	3.66	67	0.024	22	0.711	-166
270	0.818	-169	3.52	66	0.024	23	0.715	-166
280	0.821	-169	3.39	65	0.025	24	0.718	-167
290	0.822	-170	3.25	63	0.024	26	0.708	-168
300	0.823	-170	3.11	62	0.023	28	0.715	-167

Table 2. Common Source S-Parameters ( $V_{DS} = 28\text{ V}$ ,  $I_D = 1.25\text{ A}$ ) (continued)

f MHz	S <sub>11</sub>		S <sub>21</sub>		S <sub>12</sub>		S <sub>22</sub>	
	S <sub>11</sub>	φ	S <sub>21</sub>	φ	S <sub>12</sub>	φ	S <sub>22</sub>	φ
310	0.822	-170	2.99	62	0.023	29	0.725	-166
320	0.825	-170	2.89	61	0.024	31	0.734	-166
330	0.828	-171	2.78	60	0.024	33	0.736	-167
340	0.830	-171	2.66	59	0.024	33	0.724	-168
350	0.832	-171	2.59	58	0.024	37	0.739	-166
360	0.834	-171	2.52	57	0.024	39	0.757	-166
370	0.836	-171	2.44	56	0.023	39	0.755	-167
380	0.839	-172	2.34	55	0.023	38	0.745	-167
390	0.840	-172	2.26	54	0.024	40	0.738	-168
400	0.841	-172	2.19	54	0.024	46	0.735	-166
410	0.842	-172	2.14	53	0.025	46	0.787	-167
420	0.844	-172	2.09	51	0.026	46	0.790	-168
430	0.845	-173	1.99	51	0.027	49	0.777	-168
440	0.846	-173	1.93	51	0.026	52	0.770	-167
450	0.849	-173	1.91	49	0.027	53	0.794	-167
460	0.853	-173	1.84	48	0.027	51	0.803	-171
470	0.855	-173	1.77	47	0.027	54	0.787	-170
480	0.857	-174	1.72	47	0.027	57	0.789	-169
490	0.857	-174	1.68	47	0.027	56	0.796	-168
500	0.859	-174	1.64	46	0.029	57	0.802	-169
600	0.862	-179	1.18	33	0.036	77	0.851	-173
700	0.893	178	0.921	26	0.043	75	0.856	-175
800	0.890	175	0.771	22	0.043	78	0.880	-178
900	0.895	173	0.635	17	0.065	74	0.882	-178
1000	0.905	171	0.544	14	0.086	69	0.931	178

## PACKAGE DIMENSIONS

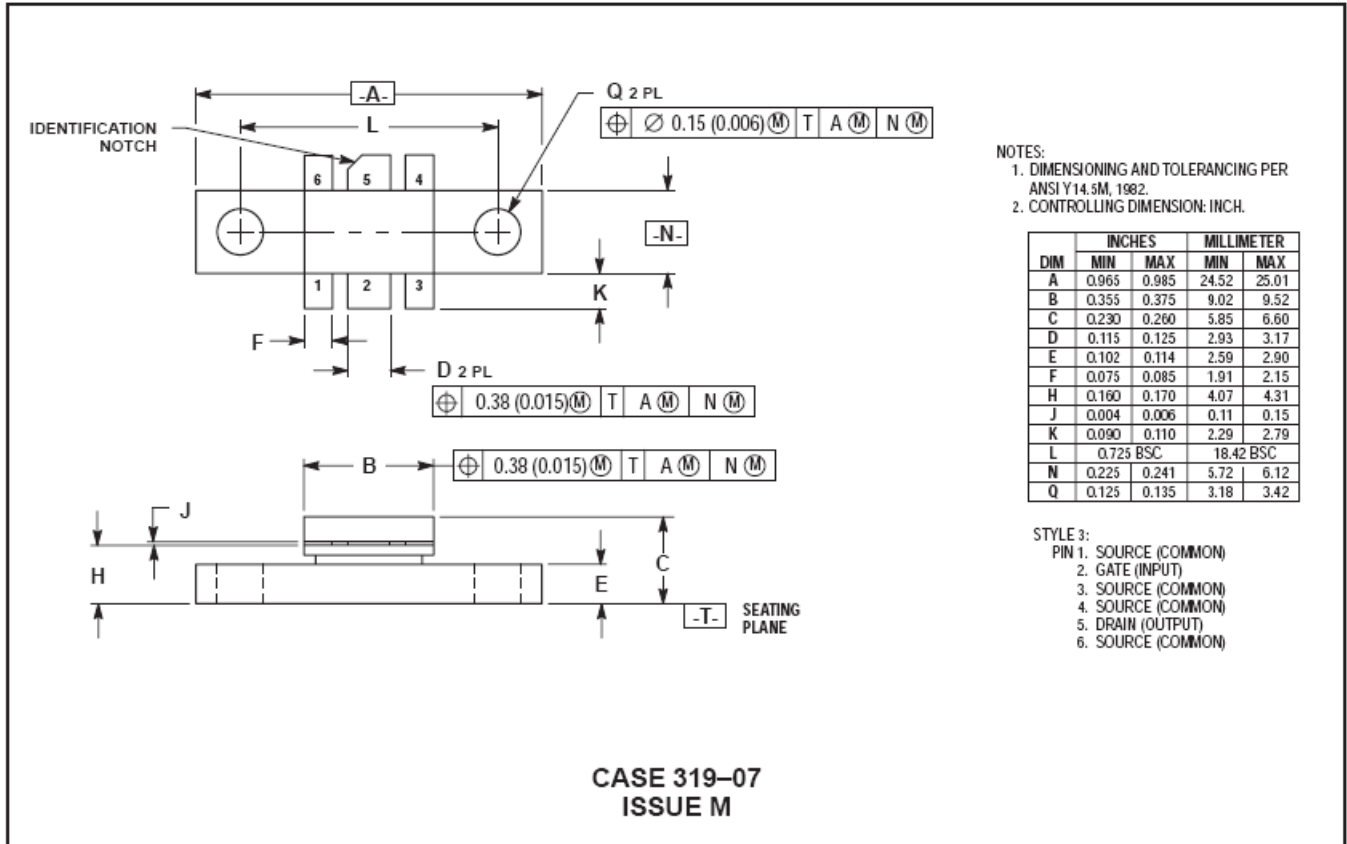

M/A-COM Technology Solutions Inc. All rights reserved.

Information in this document is provided in connection with M/A-COM Technology Solutions Inc ("MACOM") products. These materials are provided by MACOM as a service to its customers and may be used for informational purposes only. Except as provided in MACOM's Terms and Conditions of Sale for such products or in any separate agreement related to this document, MACOM assumes no liability whatsoever. MACOM assumes no responsibility for errors or omissions in these materials. MACOM may make changes to specifications and product descriptions at any time, without notice. MACOM makes no commitment to update the information and shall have no responsibility whatsoever for conflicts or incompatibilities arising from future changes to its specifications and product descriptions. No license, express or implied, by estoppel or otherwise, to any intellectual property rights is granted by this document.

THESE MATERIALS ARE PROVIDED "AS IS" WITHOUT WARRANTY OF ANY KIND, EITHER EXPRESS OR IMPLIED, RELATING TO SALE AND/OR USE OF MACOM PRODUCTS INCLUDING LIABILITY OR WARRANTIES RELATING TO FITNESS FOR A PARTICULAR PURPOSE, CONSEQUENTIAL OR INCIDENTAL DAMAGES, MERCHANTABILITY, OR INFRINGEMENT OF ANY PATENT, COPYRIGHT OR OTHER INTELLECTUAL PROPERTY RIGHT. MACOM FURTHER DOES NOT WARRANT THE ACCURACY OR COMPLETENESS OF THE INFORMATION, TEXT, GRAPHICS OR OTHER ITEMS CONTAINED WITHIN THESE MATERIALS. MACOM SHALL NOT BE LIABLE FOR ANY SPECIAL, INDIRECT, INCIDENTAL, OR CONSEQUENTIAL DAMAGES, INCLUDING WITHOUT LIMITATION, LOST REVENUES OR LOST PROFITS, WHICH MAY RESULT FROM THE USE OF THESE MATERIALS.

MACOM products are not intended for use in medical, lifesaving or life sustaining applications. MACOM customers using or selling MACOM products for use in such applications do so at their own risk and agree to fully indemnify MACOM for any damages resulting from such improper use or sale.