



### FEATURES

- UL60950 recognised
- RoHS compliant
- Typical efficiency from 83%
- Power density 2.68W/cm<sup>3</sup>
- Wide temperature performance at full 3 Watt load, -40°C to 85°C<sup>3</sup>
- UL 94V-0 package material
- No heatsink required
- Industry standard pinout
- 5V & 12V input
- 5V, 9V, 12V, & 15V output
- Fully encapsulated with toroidal magnetics
- No external components required
- No electrolytic or tantalum capacitors

### PRODUCT OVERVIEW

The MEE3 series is a new range of high performance 3W DC-DC converters, offering 3W of available output power in a previously rated 2W package capable of operation over the full industrial temperature range of -40°C to 85°C<sup>3</sup>. Available in an industry standard SIP package, with a pin compatible power upgrade path from the 1W NME/NKE and 2W NML series<sup>1</sup>, they are ideally suited for providing local supplies on control system boards with the added benefit of 1kVDC galvanic isolation.



For full details go to  
[www.murata-ps.com/rohs](http://www.murata-ps.com/rohs)

### SELECTION GUIDE

Order Code	Nominal Input Voltage	Output Voltage	Output Current	Input Current at Rated Load	Load Regulation (Typ)	Load Regulation (Max)	Ripple & Noise (Typ) <sup>1</sup>	Ripple & Noise (Max) <sup>1</sup>	Efficiency (Min.)	Efficiency (Typ.)	Isolation Capacitance	MTTF <sup>2</sup>
	V	V	mA	mA	%	%	mVp-p	mVp-p	%	%	pF	MHrs
MEE3S0505SC	5	5	600	703	6.3	8	46	70	80	83	32	3.9
MEE3S0509SC	5	9	333	677	5.2	6.5	28	45	84	87	50	2.9
MEE3S0512SC	5	12	250	691	4.7	6	26	45	83	86	41	4.2
MEE3S0515SC	5	15	200	679	4.7	6.5	24	45	85	88	51	2.5
MEE3S1205SC	12	5	600	290	4.3	6	41	60	82	85	42	3.6
MEE3S1209SC	12	9	333	280	3.5	5	21	40	84	88	66	3.7
MEE3S1212SC	12	12	250	280	3	4.5	19	40	84	88	77	3.4
MEE3S1215SC	12	15	200	277	2.7	4	21	40	85	89	91	3.4

### INPUT CHARACTERISTICS

Parameter	Conditions	Min.	Typ.	Max.	Units
Voltage range	Continuous operation, 5V input types	4.5	5	5.5	V
	Continuous operation, 12V input types	10.8	12	13.2	
Reflected ripple current	5V input types		5	15	mA p-p
	12V input types		5	15	

### OUTPUT CHARACTERISTICS

Parameter	Conditions	Min.	Typ.	Max.	Units
Rated Power	T <sub>A</sub> = -40°C to 85°C			3	W
Voltage Set Point Accuracy	See tolerance envelope				
Line regulation	High V <sub>IN</sub> to low V <sub>IN</sub>		1.01	1.1	%/%

### ISOLATION CHARACTERISTICS

Parameter	Conditions	Min.	Typ.	Max.	Units
Isolation test voltage	Flash tested for 1 second	1000			VDC
Resistance	Viso = 1000VDC	10			GΩ

### GENERAL CHARACTERISTICS

Parameter	Conditions	Min.	Typ.	Max.	Units
Switching frequency			60		kHz

### TEMPERATURE CHARACTERISTICS

Parameter	Conditions	Min.	Typ.	Max.	Units
Specification	All output types	-40		85	°C
Storage		-50		125	
Case Temperature rise above ambient	MEE3Sxx05SC, MEE3S0512C			40	
	MEE3S0515C, MEE3S1209C, MEE3S1212C			35	
	MEE3S1215C, MEE3S0509C			30	
Cooling	Free air convection				

### ABSOLUTE MAXIMUM RATINGS

Lead temperature 1mm from case for 10 seconds	260°C
Input voltage V <sub>IN</sub> , MEE3S05 types	7V
Input voltage V <sub>IN</sub> , MEE3S12 types	15V

1. See Ripple & Noise characterisation method.
  2. Calculated using MIL-HDBK-217F FN2 with nominal input voltage at full load.
  3. See safety approval section on page 2.
- All specifications typical at T<sub>A</sub> = 25°C, nominal input voltage and rated output current unless otherwise specified.

**TEMPERATURE DERATING GRAPH**

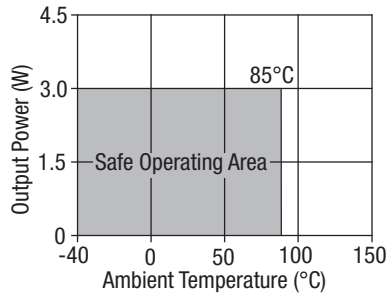

**OUTPUT VOLTAGE TOLERANCE ENVELOPE**

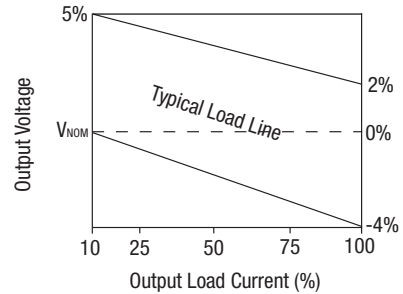

The voltage tolerance envelope shows typical load regulation characteristics for this product series. The tolerance envelope is the maximum output voltage variation due to changes in output loading.

**TECHNICAL NOTES**

**ISOLATION VOLTAGE**

'Hi Pot Test', 'Flash Tested', 'Withstand Voltage', 'Proof Voltage', 'Dielectric Withstand Voltage' & 'Isolation Test Voltage' are all terms that relate to the same thing, a test voltage, applied for a specified time, across a component designed to provide electrical isolation, to verify the integrity of that isolation.

Murata Power Solutions MEE3 series of DC-DC converters are all 100% production tested at their stated isolation voltage. This is 1kVDC for 1 second.

A question commonly asked is, "What is the continuous voltage that can be applied across the part in normal operation?"

The MEE3 series has been recognized by Underwriters Laboratory for functional isolation. Both input and output should normally be maintained within SELV limits i.e. less than 42.4V peak, or 60VDC. The isolation test voltage represents a measure of immunity to transient voltages and the part should never be used as an element of a safety isolation system. The part could be expected to function correctly with several hundred volts offset applied continuously across the isolation barrier; but then the circuitry on both sides of the barrier must be regarded as operating at an unsafe voltage and further isolation/insulation systems must form a barrier between these circuits and any user-accessible circuitry according to safety standard requirements.

**REPEATED HIGH-VOLTAGE ISOLATION TESTING**

It is well known that repeated high-voltage isolation testing of a barrier component can actually degrade isolation capability, to a lesser or greater degree depending on materials, construction and environment. The MEE3 series has toroidal isolation transformers, with no additional insulation between primary and secondary windings of enamelled wire. While parts can be expected to withstand several times the stated test voltage, the isolation capability does depend on the wire insulation. Any material, including this enamel (typically polyurethane) is susceptible to eventual chemical degradation when subject to very high applied voltages thus implying that the number of tests should be strictly limited. We therefore strongly advise against repeated high voltage isolation testing, but if it is absolutely required, that the voltage be reduced by 20% from specified test voltage.

This consideration equally applies to agency recognized parts rated for better than functional isolation where the wire enamel insulation is always supplemented by a further insulation system of physical spacing or barriers.

**RoHS COMPLIANT INFORMATION**



This series is compatible with RoHS soldering systems with a peak wave solder temperature of 260°C for 10 seconds. The pin termination finish is Tin Plate, Hot Dipped over Matte Tin with Nickel Preplate. They are backward compatible with Sn/Pb soldering systems. For further information, please visit [www.murata-ps.com/rohs](http://www.murata-ps.com/rohs)

**SAFETY APPROVAL**

The MEE3 series has been recognized by Underwriters Laboratory (UL) to UL 60950 for functional isolation in a maximum still air ambient temperature of 63°C and/or case temperature limit of 91°C. Case temperature measured on the face opposite the pins. File number E151252 applies.

The MEE3 series of converters are not internally fused so to meet the requirement of UL 60950, an input line fuse should always be used. An anti-surge 2.5A should be used for MEE3S05XXSC models, and an anti-surge 1A should be used for MEE3S12xxSC models. All fuses should be UL approved and rated to at least the maximum allowable DC input voltage.

**APPLICATION NOTES**

**Output Ripple Reduction**

By using the values of inductance and capacitance stated, the output ripple at the rated load is lowered to 5mV p-p max.

**Component selection**

**Capacitor:** It is required that the ESR (Equivalent Series Resistance) should be as low as possible, ceramic types are recommended. The voltage rating should be at least twice (except for 15V output), the rated output voltage of the DC-DC converter.

**Inductor:** The rated current of the inductor should not be less than that of the output of the DC-DC converter. At the rated current, the DC resistance of the inductor should be such that the voltage drop across the inductor is <2% of the rated voltage of the DC-DC converter. The SRF (Self Resonant Frequency) should be >20MHz.

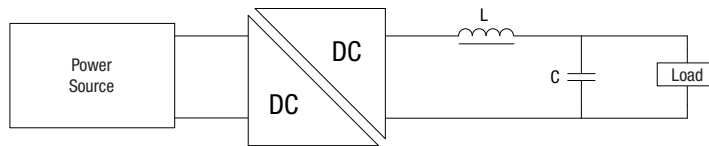

	Inductor			Capacitor
	L, $\mu$ H	SMD	Through Hole	C, $\mu$ F
MEE3S0505SC	10	84103C	11R103C	4.7
MEE3S0509SC	22	84223C	11R223C	2.2
MEE3S0512SC	47	84473C	11R473C	1
MEE3S0515SC	47	84473C	11R473C	1
MEE3S1205SC	10	84103C	11R103C	4.7
MEE3S1209SC	22	84223C	11R223C	2.2
MEE3S1212SC	47	84473C	11R473C	1
MEE3S1215SC	47	84473C	11R473C	1

**Ripple & Noise Characterisation Method**

Ripple and noise measurements are performed with the following test configuration.

C1	1 $\mu$ F X7R multilayer ceramic capacitor, voltage rating to be a minimum of 3 times the output voltage of the DC-DC converter
C2	10 $\mu$ F tantalum capacitor, voltage rating to be a minimum of 1.5 times the output voltage of the DC-DC converter with an ESR of less than 100m $\Omega$ at 100 kHz
C3	100nF multilayer ceramic capacitor, general purpose
R1	450 $\Omega$ resistor, carbon film, $\pm$ 1% tolerance
R2	50 $\Omega$ BNC termination
T1	3T of the coax cable through a ferrite toroid
RLOAD	Resistive load to the maximum power rating of the DC-DC converter. Connections should be made via twisted wires

Measured values are multiplied by 10 to obtain the specified values.

**Differential Mode Noise Test Schematic**

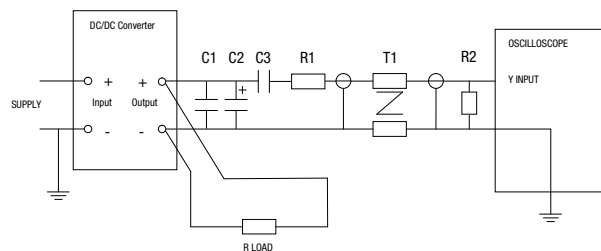

**APPLICATION NOTES (continued)**

**Minimum Load**

The minimum load to meet datasheet specification is 10% of the full rated load across the specified input voltage range. Lower than 10% minimum loading will result in an increase in output voltage, which may rise to typically 1.25 times the specified output voltage if the output load falls to less than 5%.

**Capacitive Loading & Start Up**

Typical start up times for this series, with a typical input voltage rise time of 2.2µs with resistive only load, and with added output capacitance of 47µF, are shown in the table below

Part Number	Start-Up Time µS
MEE3S0505SC	490
MEE3S0509SC	1130
MEE3S0512SC	2070
MEE3S0515SC	3515
MEE3S1205SC	415
MEE3S1209SC	715
MEE3S1212SC	1100
MEE3S1215SC	1430

Typical Start-Up Wave Form

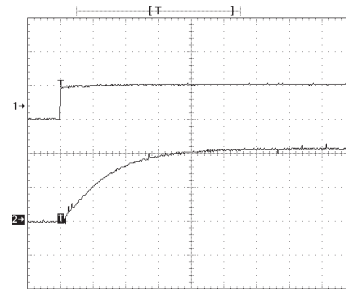

**EFFICIENCY VS LOAD**

**MEE3S05XXSC Input Voltage**

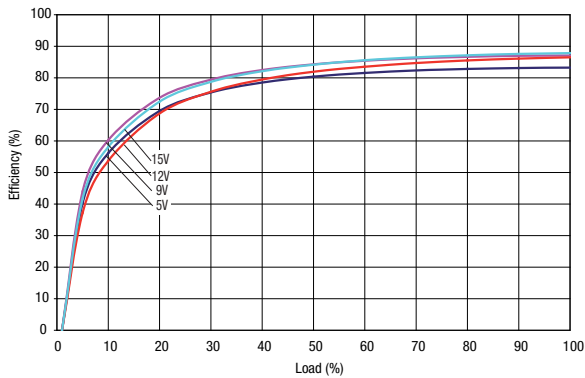

**MEE3S12XXSC Input Voltage**

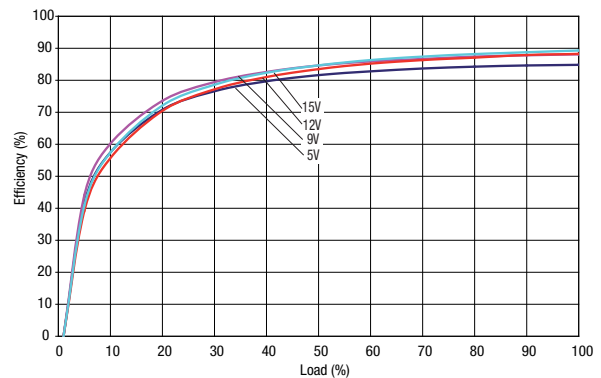

**PACKAGE SPECIFICATIONS**

**MECHANICAL DIMENSIONS**

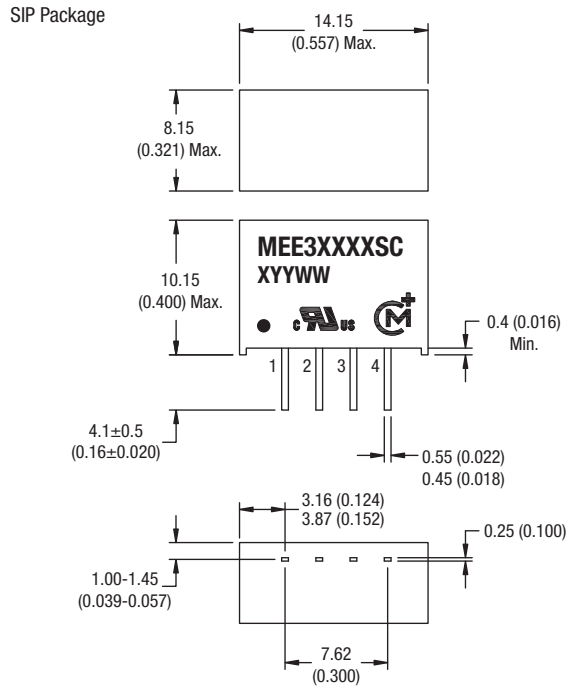

All dimensions in mm  $\pm 0.1$ mm (inches  $\pm 0.004$ ). All pins on a 2.54 (0.1) pitch and within  $\pm 0.25$  (0.01) of true position. Weight: 2.3 g

**PIN CONNECTIONS - 4 PIN SIP**

Pin	Function
1	-VIN
2	+VIN
3	-VOUT
4	+VOUT

**TUBE OUTLINE DIMENSIONS**

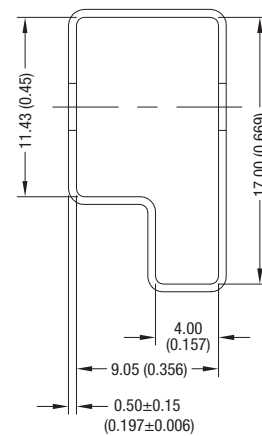

Unless otherwise stated all dimensions in mm (inches)  $\pm 0.5$ mm. Tube length: 520mm  $\pm 2$ mm (20.47). Tube Quantity: 35

**RECOMMENDED FOOTPRINT DETAILS**

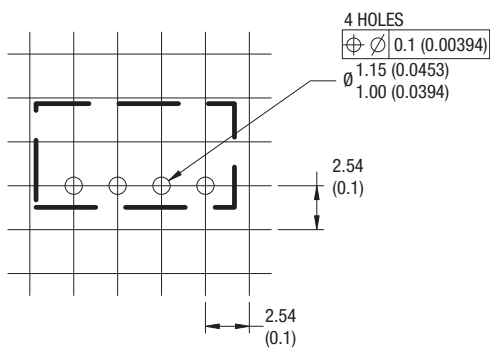

Unless otherwise stated all dimensions in mm (inches)  $\pm 0.5$ mm.



This product is subject to the following **operating requirements** and the **Life and Safety Critical Application Sales Policy**:

Refer to: <http://www.murata-ps.com/requirements/>

Murata Power Solutions, Inc. makes no representation that the use of its products in the circuits described herein, or the use of other technical information contained herein, will not infringe upon existing or future patent rights. The descriptions contained herein do not imply the granting of licenses to make, use, or sell equipment constructed in accordance therewith. Specifications are subject to change without notice. ©2018 Murata Power Solutions, Inc.