

## 2.6W Stereo Audio Power Amplifiers and DirectDrive Headphone Amplifiers

### General Description

The MAX9750/MAX9751/MAX9755 combine a stereo, 2.6W audio power amplifier and stereo DirectDrive® 110mW headphone amplifier in a single device. The headphone amplifier uses Maxim's DirectDrive architecture that produces a ground-referenced output from a single supply, eliminating the need for large DC-blocking capacitors, saving cost, space, and component height. A high 90dB PSRR and low 0.01% THD+N ensures clean, low-distortion amplification of the audio signal.

The MAX9750 features an analog volume control, and a BEEP input. The MAX9751 features a 2:1 input multiplexer, allowing multiple audio sources to be selected. All devices feature a single-supply voltage, a shutdown mode, logic-selectable gain, and a headphone sense input. Industry-leading click-and-pop suppression eliminates audible transients during power and shutdown cycles.

The MAX9750/MAX9751/MAX9755 are offered in a space-saving, thermally efficient 28-pin thin QFN (5mm x 5mm x 0.8mm) package. These devices have thermal-overload and output short-circuit protection, and are specified over the extended -40°C to +85°C temperature range.

### Applications

Notebook PCs	Flat-Panel TVs
Tablet PCs	PC Displays
Portable DVD Players	LCD Projectors

### Simplified Block Diagrams

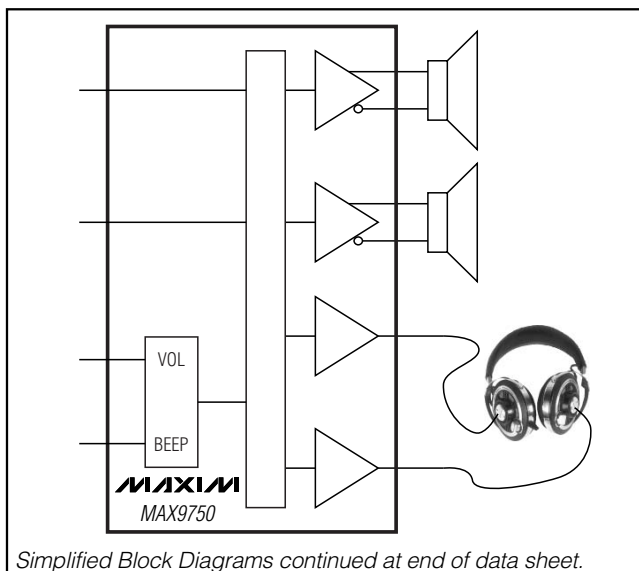

### Features

- ◆ No DC-Blocking Capacitors Required—Provides Industry's Most Compact Notebook Audio Solution
- ◆ PC2001 Compliant
- ◆ 5V Single-Supply Operation
- ◆ Class AB 2.6W Stereo BTL Speaker Amplifiers
- ◆ 110mW DirectDrive Headphone Amplifiers
- ◆ High 90dB PSRR
- ◆ Low-Power Shutdown Mode
- ◆ Industry-Leading Click-and-Pop Suppression
- ◆ Low 0.01% THD+N at 1kHz
- ◆ Short-Circuit and Thermal Protection
- ◆ Selectable Gain Settings
- ◆ Analog Volume Control (MAX9750)
- ◆ BEEP Input with Glitch Filter (MAX9750)
- ◆ 2:1 Stereo Input MUX (MAX9751)
- ◆ ±8kV ESD-Protected Headphone Driver Outputs
- ◆ Available in Space-Saving, Thermally Efficient 28-Pin Thin QFN (5mm x 5mm x 0.8mm) Package

### Ordering Information

PART*	PIN-PACKAGE	MAXIMUM GAIN (dB)
MAX9750AETI+	28 Thin QFN	13.5
MAX9750BETI+	28 Thin QFN	19.5
MAX9750CETI+	28 Thin QFN	10.5
MAX9751ETI+	28 Thin QFN	10.5
MAX9755ETI+	28 Thin QFN	10.5

\*Denotes a lead-free/RoHS-compliant package.

\*All devices specified over the -40°C to +85°C temperature range.

DirectDrive is a registered trademark of Maxim Integrated Products, Inc.

## 2.6W Stereo Audio Power Amplifiers and DirectDrive Headphone Amplifiers

### ABSOLUTE MAXIMUM RATINGS

Supply Voltage ( $V_{DD}$ ,  $PV_{DD}$ ,  $HPV_{DD}$ ,  $CPV_{DD}$  to GND) ..... +6V  
 GND to PGND .....  $\pm 0.3V$   
 $CPV_{SS}$ , C1N,  $V_{SS}$  to GND ..... -6.0V to (GND + 0.3V)  
 HPOUT\_ to GND .....  $\pm 3V$   
 Any Other Pin ..... -0.3V to ( $V_{DD}$  + 0.3V)  
 Duration of OUT\_ Short Circuit to GND or  $PV_{DD}$  ..... Continuous  
 Duration of OUT\_+ Short Circuit to OUT\_-, ..... Continuous  
 Duration of HPOUT\_ Short Circuit to GND,  
 $V_{SS}$  or  $HPV_{DD}$  ..... Continuous  
 Continuous Current ( $PV_{DD}$ , OUT\_-, PGND) ..... 1.7A  
 Continuous Current ( $CPV_{DD}$ , C1N, C1P,  $CPV_{SS}$ ,  $V_{SS}$ ,  $HPV_{DD}$ ,  
 HPOUT\_) ..... 850mA

Continuous Input Current (All Other Pins) .....  $\pm 20mA$   
 Continuous Power Dissipation ( $T_A = +70^\circ C$ , multilayer board)  
 28-Pin Thin QFN (derate 23.8mW/ $^\circ C$  above  $+70^\circ C$ ) .1900mW  
 Junction-to-Case Thermal Resistance ( $\theta_{JC}$ )  
 28-Pin Thin QFN .....  $24^\circ C/W$   
 Junction Temperature .....  $+150^\circ C$   
 Operating Temperature Range .....  $-40^\circ C$  to  $+85^\circ C$   
 Storage Temperature Range .....  $-65^\circ C$  to  $+150^\circ C$   
 Lead Temperature (soldering, 10s) .....  $+300^\circ C$

Stresses beyond those listed under "Absolute Maximum Ratings" may cause permanent damage to the device. These are stress ratings only, and functional operation of the device at these or any other conditions beyond those indicated in the operational sections of the specifications is not implied. Exposure to absolute maximum rating conditions for extended periods may affect device reliability.

### ELECTRICAL CHARACTERISTICS

( $V_{DD} = PV_{DD} = CPV_{DD} = HPV_{DD} = 5V$ ,  $V_{GND} = V_{PGND} = V_{CPGND} = 0V$ ,  $\overline{SHDN} = V_{DD}$ ,  $C_{BIAS} = 1\mu F$ ,  $C_1 = C_2 = 1\mu F$ , speaker load terminated between OUT\_+ and OUT\_-, headphone load terminated between HPOUT\_ and GND,  $V_{GAIN1} = V_{GAIN2} = V_{VOL} = V_{GAIN} = 0V$ ,  $T_A = T_{MIN}$  to  $T_{MAX}$ , unless otherwise noted. Typical values are at  $T_A = +25^\circ C$ .) (Note 1)

PARAMETER	SYMBOL	CONDITIONS		MIN	TYP	MAX	UNITS
<b>GENERAL</b>							
Supply Voltage Range	$V_{DD}$ , $PV_{DD}$	Inferred from PSRR test		4.5		5.5	V
Headphone Supply Voltage	$CPV_{DD}$ , $HPV_{DD}$	Inferred from PSRR test		3.0		5.5	V
Quiescent Supply Current	$I_{DD}$	HPS = GND, speaker mode, $R_L = \infty$			14	29	mA
		HPS = $V_{DD}$ , headphone mode, $R_L = \infty$			7	13	
Shutdown Supply Current	$I_{SHDN}$	$\overline{SHDN} = GND$			0.2	5	$\mu A$
Bias Voltage	$V_{BIAS}$			1.7	1.8	1.9	V
Switching Time	$t_{SW}$	Gain or input switching			10		$\mu s$
Input Resistance	$R_{IN}$	Amplifier inputs (Note 2)	MAX9750	10	20	30	k $\Omega$
			MAX9751/MAX9755	4.5	6	8.0	
Turn-On Time	$t_{SON}$				25		ms
<b>SPEAKER AMPLIFIER (HPS = GND)</b>							
Output Offset Voltage	$V_{OS}$	Measured between OUT_+ and OUT_-, $T_A = +25^\circ C$	MAX9750A/MAX9750B/ MAX9751/MAX9755		$\pm 1$	$\pm 15$	mV
			MAX9750C		$\pm 0.4$	$\pm 6$	
Power-Supply Rejection Ratio (Note 3)	PSRR	$PV_{DD}$ or $V_{DD} =$ 4.5V to 5.5V ( $T_A = +25^\circ C$ )	MAX9750A/MAX9750B/ MAX9750C/MAX9751	75	90		dB
			MAX9755	72	90		
			$f = 1kHz$ , $V_{RIPPLE} = 200mV_{P-P}$		80		
		$f = 10kHz$ , $V_{RIPPLE} = 200mV_{P-P}$			55		

# 2.6W Stereo Audio Power Amplifiers and DirectDrive Headphone Amplifiers

MAX9750/MAX9751/MAX9755

## ELECTRICAL CHARACTERISTICS (continued)

(V<sub>DD</sub> = P<sub>VDD</sub> = CP<sub>VDD</sub> = HP<sub>VDD</sub> = 5V, V<sub>GND</sub> = V<sub>PGND</sub> = V<sub>CPGND</sub> = 0V,  $\overline{\text{SHDN}}$  = V<sub>DD</sub>, C<sub>BIAS</sub> = 1μF, C<sub>1</sub> = C<sub>2</sub> = 1μF, speaker load terminated between OUT<sub>+</sub> and OUT<sub>-</sub>, headphone load terminated between HPOUT<sub>-</sub> and GND, V<sub>GAIN1</sub> = V<sub>GAIN2</sub> = V<sub>VOL</sub> = V<sub>GAIN</sub> = 0V, T<sub>A</sub> = T<sub>MIN</sub> to T<sub>MAX</sub>, unless otherwise noted. Typical values are at T<sub>A</sub> = +25°C.) (Note 1)

PARAMETER	SYMBOL	CONDITIONS		MIN	TYP	MAX	UNITS
Output Power (Note 4)	P <sub>OUT</sub>	THD+N = 1%, f = 1kHz, T <sub>A</sub> = +25°C	R <sub>L</sub> = 8Ω	MAX9750A/ MAX9750B/ MAX9751/ MAX9755	0.9	1.4	W
				MAX9750C	0.65	0.8	
			R <sub>L</sub> = 4Ω	MAX9750A/ MAX9750B/ MAX9751/ MAX9755	2.3		
				MAX9750C	1.2	1.5	
			R <sub>L</sub> = 3Ω	MAX9750A/ MAX9750B/ MAX9751/ MAX9755	2.6		
				MAX9750C	2.2		
Total Harmonic Distortion Plus Noise	THD+N	R <sub>L</sub> = 8Ω, P <sub>OUT</sub> = 500mW, f = 1kHz		0.01		%	
		R <sub>L</sub> = 4Ω, P <sub>OUT</sub> = 1W, f = 1kHz		0.02			
Signal-to-Noise Ratio	SNR	R <sub>L</sub> = 8Ω, P <sub>OUT</sub> = 500mW, BW = 22Hz to 22kHz		96		dB	
Noise	V <sub>n</sub>	BW = 22Hz to 22kHz, A-weighted		22		μV <sub>RMS</sub>	
Capacitive-Load Drive	C <sub>L</sub>	No sustained oscillations		200		pF	
Crosstalk		L to R, R to L, f = 10kHz		75		dB	
Off-Isolation		Any unselected input to any active input, f = 10kHz (MAX9751), input referred		75			
Slew Rate	SR			1.4		V/μs	
Gain (Maximum Volume Setting)	A <sub>VMAX</sub> (SPKR)	MAX9750A	GAIN1 = 0, GAIN2 = 0		9		dB
			GAIN1 = 1, GAIN2 = 0		10.5		
			GAIN1 = 0, GAIN2 = 1		12		
			GAIN1 = 1, GAIN2 = 1		13.5		
		MAX9750B	GAIN1 = 0, GAIN2 = 0		15		
			GAIN1 = 1, GAIN2 = 0		16.5		
			GAIN1 = 0, GAIN2 = 1		18		
			GAIN1 = 1, GAIN2 = 1		19.5		
		MAX9750C	GAIN1 = 0, GAIN2 = 0		6		
			GAIN1 = 1, GAIN2 = 0		7.5		
			GAIN1 = 0, GAIN2 = 1		9		
			GAIN1 = 1, GAIN2 = 1		10.5		
Gain (MAX9751/MAX9755)	A <sub>v</sub>	GAIN = 1		9		dB	
		GAIN = 0		10.5			

## 2.6W Stereo Audio Power Amplifiers and DirectDrive Headphone Amplifiers

### ELECTRICAL CHARACTERISTICS (continued)

( $V_{DD} = PV_{DD} = CPV_{DD} = HPV_{DD} = 5V$ ,  $V_{GND} = V_{PGND} = V_{CPGND} = 0V$ ,  $\overline{SHDN} = V_{DD}$ ,  $C_{BIAS} = 1\mu F$ ,  $C_1 = C_2 = 1\mu F$ , speaker load terminated between  $OUT_+$  and  $OUT_-$ , headphone load terminated between  $HPOUT_-$  and  $GND$ ,  $V_{GAIN1} = V_{GAIN2} = V_{VOL} = V_{GAIN} = 0V$ ,  $T_A = T_{MIN}$  to  $T_{MAX}$ , unless otherwise noted. Typical values are at  $T_A = +25^\circ C$ .) (Note 1)

PARAMETER	SYMBOL	CONDITIONS	MIN	TYP	MAX	UNITS
<b>HEADPHONE AMPLIFIER (HPS = <math>V_{DD}</math>)</b>						
Output Offset Voltage	$V_{OS}$	$T_A = +25^\circ C$		$\pm 2$	$\pm 7$	mV
Power-Supply Rejection Ratio (Note 3)	PSRR	$HPV_{DD} = 3V$ to $5.5V$ , $T_A = +25^\circ C$	60	75		dB
		$f = 1kHz$ , $V_{RIPPLE} = 200mV_{P-P}$		73		
		$f = 10kHz$ , $V_{RIPPLE} = 200mV_{P-P}$		63		
Output Power	$P_{OUT}$	THD+N = 1%, $f = 1kHz$ , $T_A = +25^\circ C$	$R_L = 32\Omega$	40	50	mW
			$R_L = 16\Omega$		110	
Total Harmonic Distortion Plus Noise	THD+N	$R_L = 32\Omega$ , $P_{OUT} = 20mW$ , $f = 1kHz$		0.007		%
		$R_L = 16\Omega$ , $P_{OUT} = 75mW$ , $f = 1kHz$		0.03		
Signal-to-Noise Ratio	SNR	$R_L = 32\Omega$ , $P_{OUT} = 50mW$ , $BW = 22Hz$ to $22kHz$		101		dB
Noise	$V_n$	$BW = 22Hz$ to $22kHz$		11		$\mu V_{RMS}$
Capacitive-Load Drive	$C_L$	No sustained oscillations		200		pF
Crosstalk		L to R, R to L, $f = 10kHz$		88		dB
Off-Isolation		Any unselected input to any active input, $f = 10kHz$ (MAX9751), input referred		74		
Slew Rate	SR			0.4		$V/\mu s$
ESD	ESD	IEC air discharge		$\pm 8$		kV
Gain	$A_v$	$GAIN2 = GAIN = 0$ , $GAIN1 = X$		3		dB
		$GAIN2 = GAIN = 1$ , $GAIN1 = X$		0		
<b>CHARGE PUMP</b>						
Charge-Pump Frequency	$f_{OSC}$		500	550	600	kHz
<b>VOLUME CONTROL (MAX9750_)</b>						
VOL Input Impedance	$R_{VOL}$			100		$M\Omega$
VOL Input Hysteresis				10		mV
Full Mute Input Voltage		(Note 5)		$0.858 \times HPV_{DD}$		V
Channel Matching		$A_v = -25dB$ to $+13.5dB$		$\pm 0.2$		dB
<b>BEEP INPUT (MAX9750_)</b>						
Beep Signal Minimum Amplitude	$V_{BEEP}$	$R_B = 33k\Omega$ (Note 6)	0.8			$V_{P-P}$
Beep Signal Minimum Frequency	$f_{BEEP}$		300			Hz

# 2.6W Stereo Audio Power Amplifiers and DirectDrive Headphone Amplifiers

MAX9750/MAX9751/MAX9755

## ELECTRICAL CHARACTERISTICS (continued)

( $V_{DD} = PV_{DD} = CPV_{DD} = HPV_{DD} = 5V$ ,  $V_{GND} = V_{PGND} = V_{CPGND} = 0V$ ,  $\overline{SHDN} = V_{DD}$ ,  $C_{BIAS} = 1\mu F$ ,  $C1 = C2 = 1\mu F$ , speaker load terminated between  $OUT_{+}$  and  $OUT_{-}$ , headphone load terminated between  $HPOUT_{-}$  and  $GND$ ,  $V_{GAIN1} = V_{GAIN2} = V_{VOL} = V_{GAIN} = 0V$ ,  $T_A = T_{MIN}$  to  $T_{MAX}$ , unless otherwise noted. Typical values are at  $T_A = +25^{\circ}C$ .) (Note 1)

PARAMETER	SYMBOL	CONDITIONS	MIN	TYP	MAX	UNITS
<b>LOGIC INPUT (<math>\overline{SHDN}</math>, GAIN1, GAIN2, GAIN, VOL, IN1/2)</b>						
Logic Input High Voltage	$V_{IH}$		2			V
Logic Input Low Voltage	$V_{IL}$				0.8	V
Logic Input Current	$I_{IN}$				$\pm 1$	$\mu A$
<b>LOGIC INPUT HEADPHONE (HPS)</b>						
Logic Input High Voltage	$V_{IH}$		2			V
Logic Input Low Voltage	$V_{IL}$				0.8	V
Logic Input Current	$I_{IN}$			10		$\mu A$

**Note 1:** All devices are 100% production tested at room temperature. All temperature limits are guaranteed by design.

**Note 2:** Guaranteed by design. Not production tested.

**Note 3:** PSRR is specified with the amplifier input connected to GND through  $C_{IN}$ .

**Note 4:** Output power levels are measured with the thin QFN's exposed paddle soldered to the ground plane.

**Note 5:** See Table 3 for details of the mute levels.

**Note 6:** The value of  $R_B$  dictates the minimum beep signal amplitude (see the *Beep Input* section).

# 2.6W Stereo Audio Power Amplifiers and DirectDrive Headphone Amplifiers

## Typical Operating Characteristics

(Measurement BW = 22Hz to 22kHz,  $T_A = +25^\circ\text{C}$ , unless otherwise noted.)

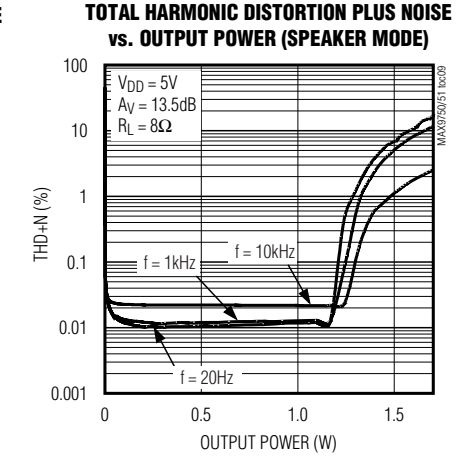
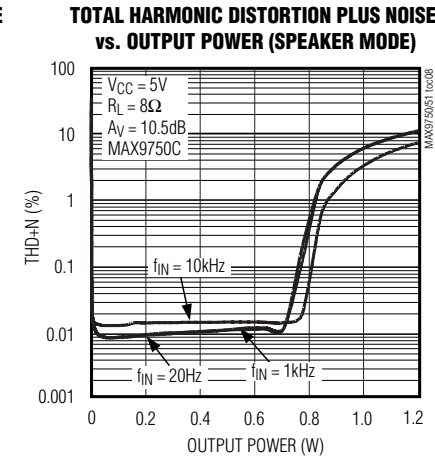
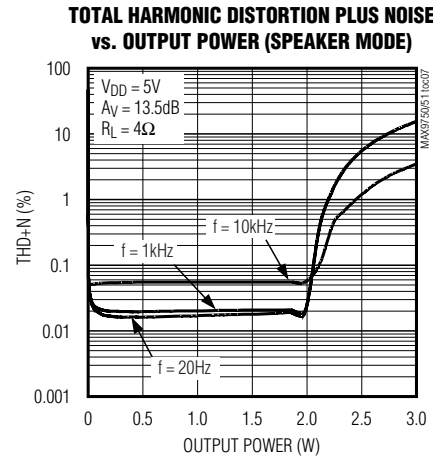
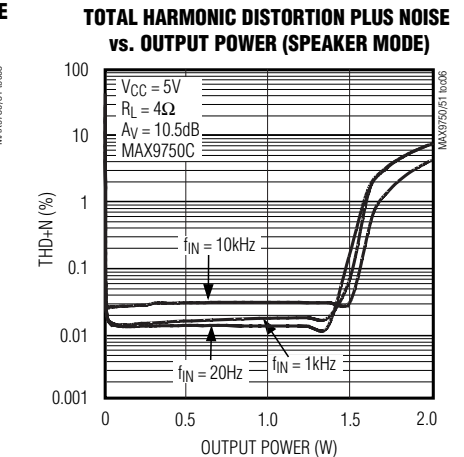
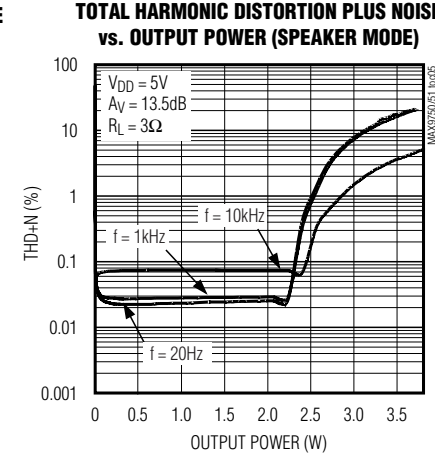
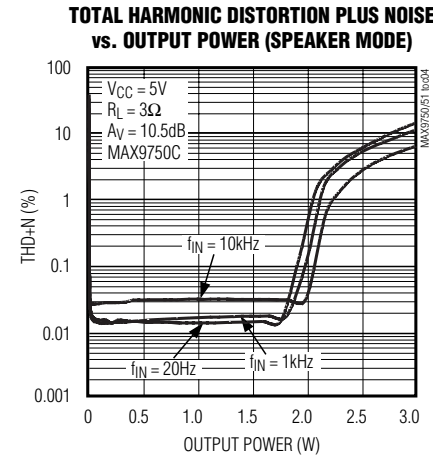
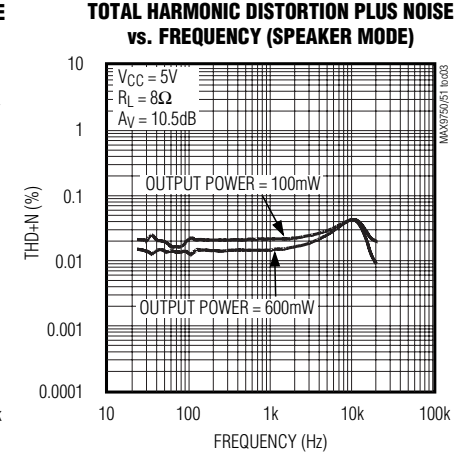
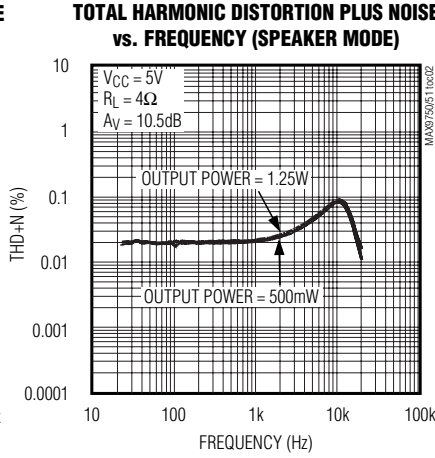
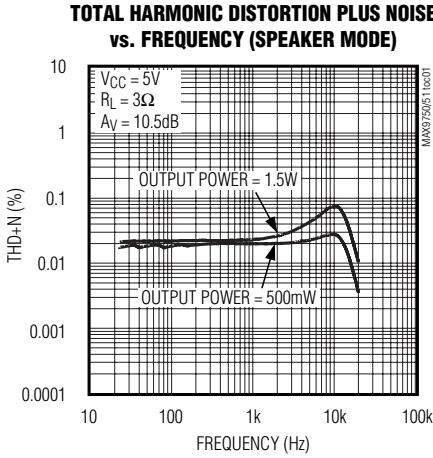

# 2.6W Stereo Audio Power Amplifiers and DirectDrive Headphone Amplifiers

## Typical Operating Characteristics (continued)

(Measurement BW = 22Hz to 22kHz,  $T_A = +25^\circ\text{C}$ , unless otherwise noted.)

MAX9750/MAX9751/MAX9755

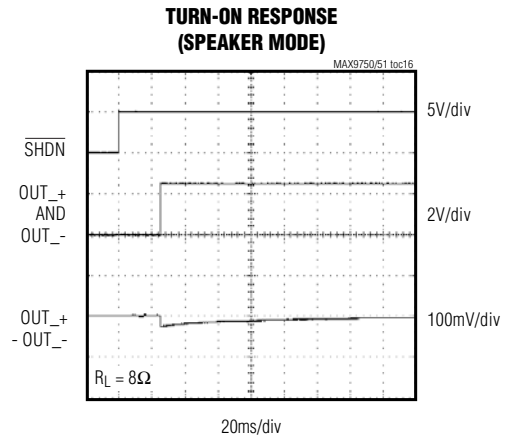
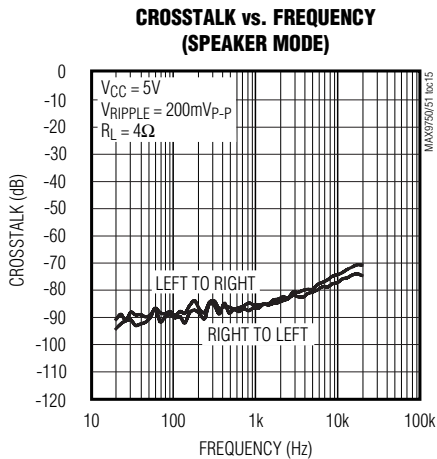
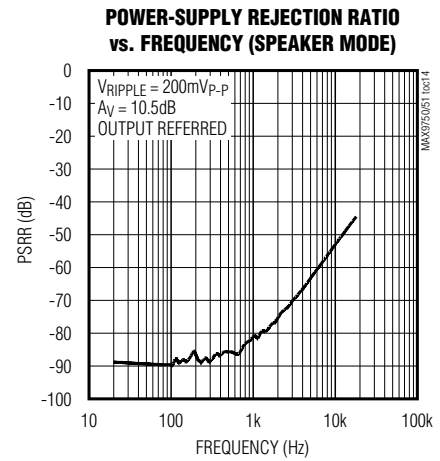
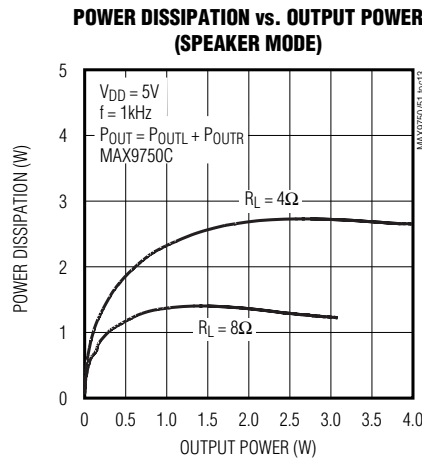
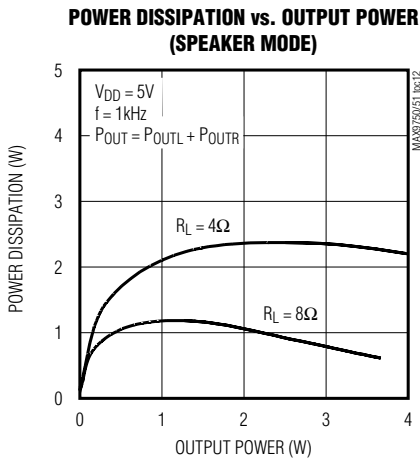
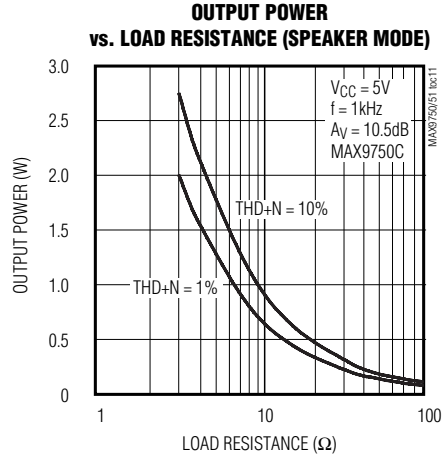
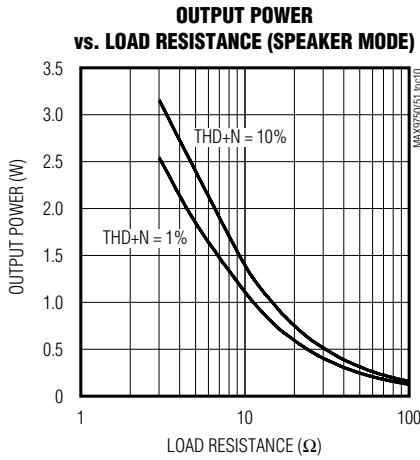

# 2.6W Stereo Audio Power Amplifiers and DirectDrive Headphone Amplifiers

## Typical Operating Characteristics (continued)

(Measurement BW = 22Hz to 22kHz,  $T_A = +25^\circ\text{C}$ , unless otherwise noted.)

**TURN-OFF RESPONSE (SPEAKER MODE)**

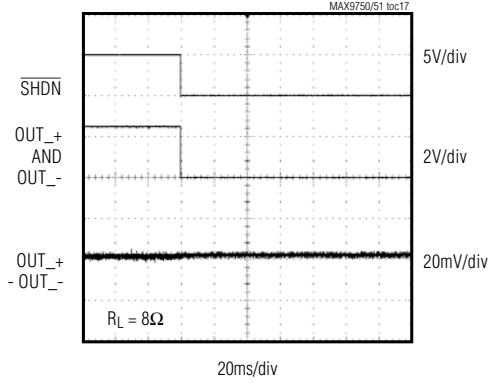

**TOTAL HARMONIC DISTORTION PLUS NOISE vs. FREQUENCY (HEADPHONE MODE)**

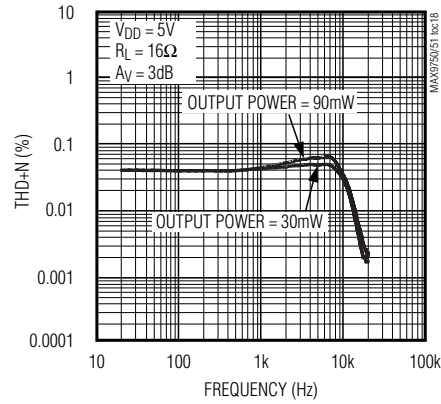

**TOTAL HARMONIC DISTORTION PLUS NOISE vs. FREQUENCY (HEADPHONE MODE)**

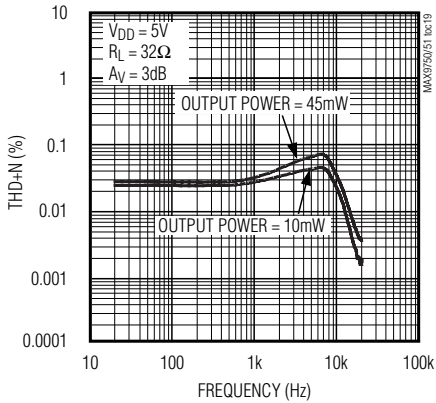

**TOTAL HARMONIC DISTORTION PLUS NOISE vs. FREQUENCY (HEADPHONE MODE)**

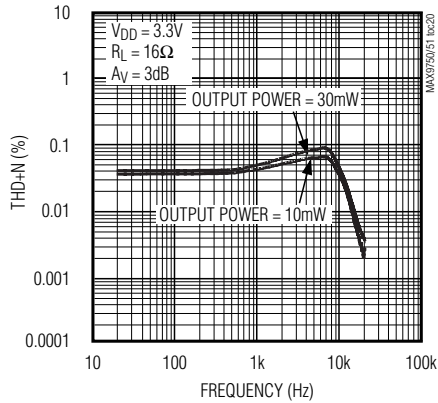

**TOTAL HARMONIC DISTORTION PLUS NOISE vs. FREQUENCY (HEADPHONE MODE)**

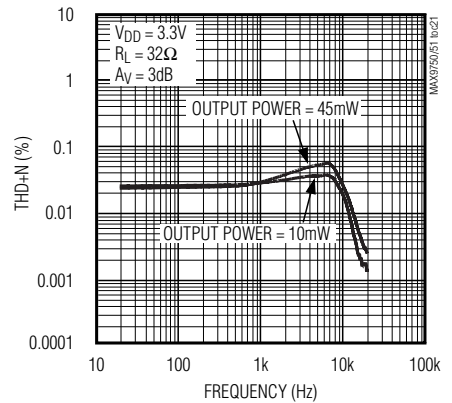

**TOTAL HARMONIC DISTORTION PLUS NOISE vs. OUTPUT POWER (HEADPHONE MODE)**

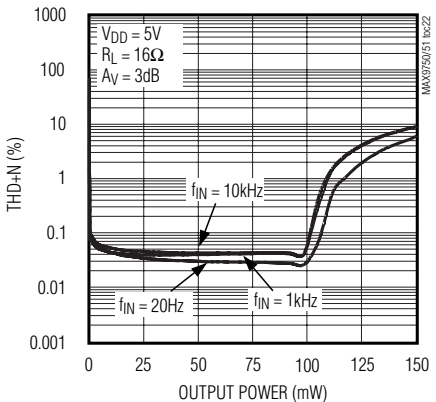

**TOTAL HARMONIC DISTORTION PLUS NOISE vs. OUTPUT POWER (HEADPHONE MODE)**

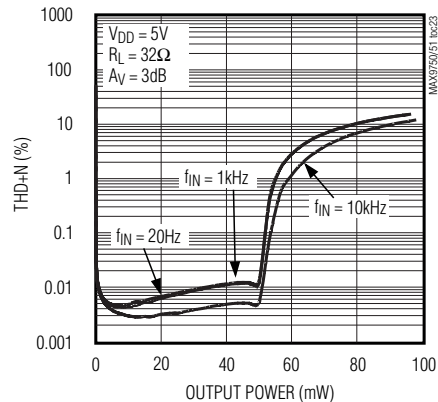

**TOTAL HARMONIC DISTORTION PLUS NOISE vs. OUTPUT POWER (HEADPHONE MODE)**

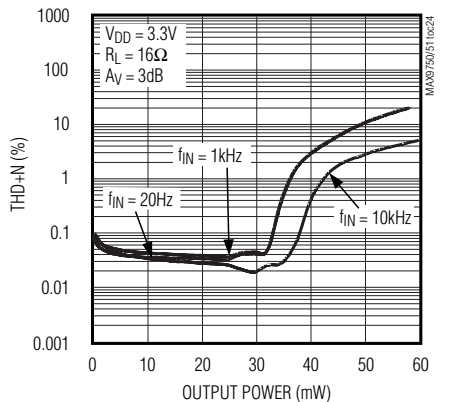



# 2.6W Stereo Audio Power Amplifiers and DirectDrive Headphone Amplifiers

## Typical Operating Characteristics (continued)

(Measurement BW = 22Hz to 22kHz,  $T_A = +25^\circ\text{C}$ , unless otherwise noted.)

MAX9750/MAX9751/MAX9755

**TOTAL HARMONIC DISTORTION PLUS NOISE vs. OUTPUT POWER (HEADPHONE MODE)**

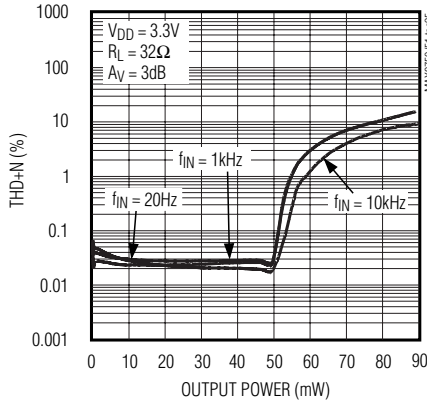

**OUTPUT POWER vs. LOAD RESISTANCE (HEADPHONE MODE)**

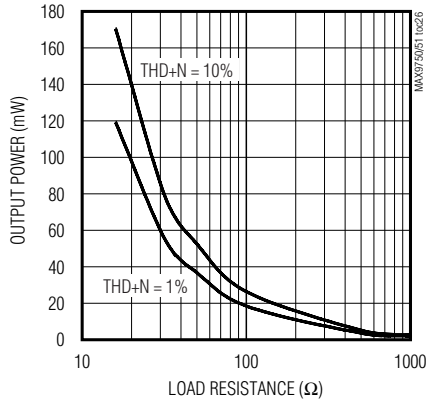

**POWER DISSIPATION vs. OUTPUT POWER (HEADPHONE MODE)**

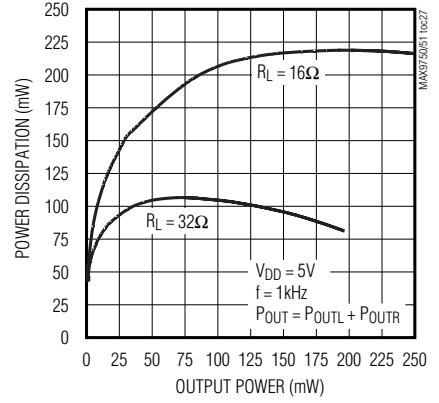

**OUTPUT POWER vs. SUPPLY VOLTAGE (HEADPHONE MODE)**

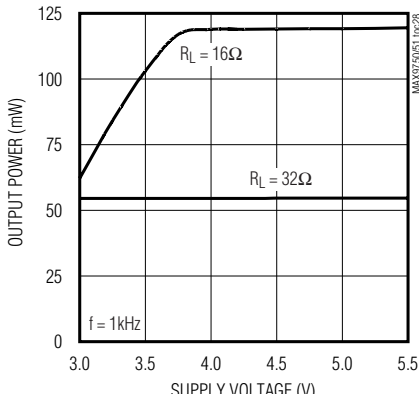

**POWER-SUPPLY REJECTION RATIO vs. FREQUENCY (HEADPHONE MODE)**

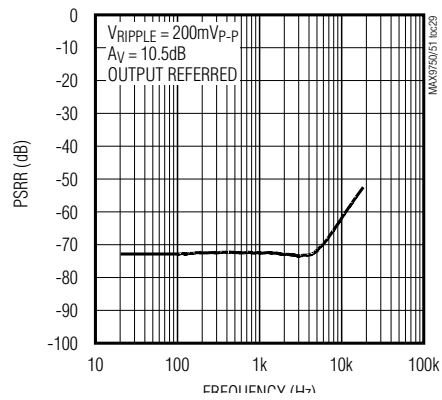

**CROSSTALK vs. FREQUENCY (HEADPHONE MODE)**

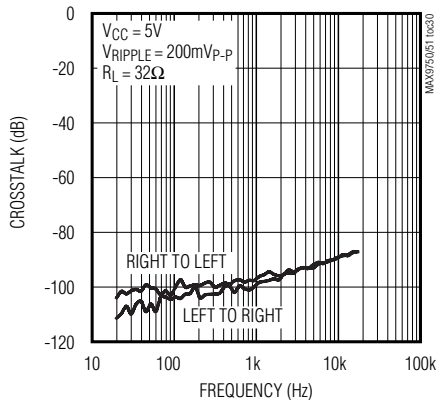

**OUTPUT POWER vs. CHARGE-PUMP CAPACITANCE AND LOAD RESISTANCE**

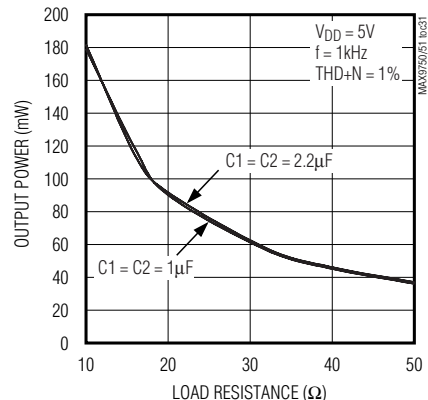

# 2.6W Stereo Audio Power Amplifiers and DirectDrive Headphone Amplifiers

## Typical Operating Characteristics (continued)

(Measurement BW = 22Hz to 22kHz,  $T_A = +25^\circ\text{C}$ , unless otherwise noted.)

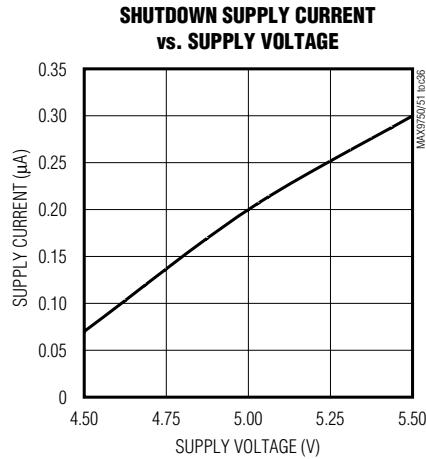
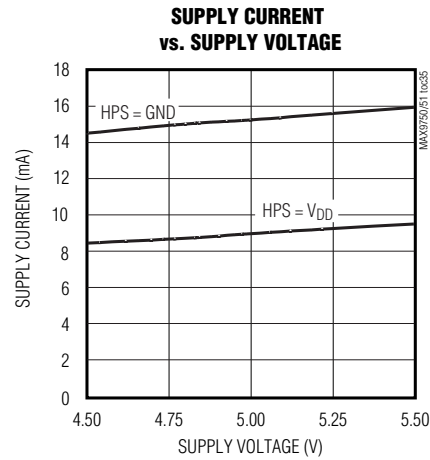
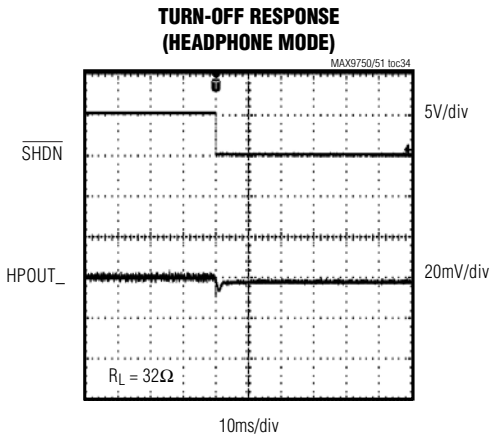
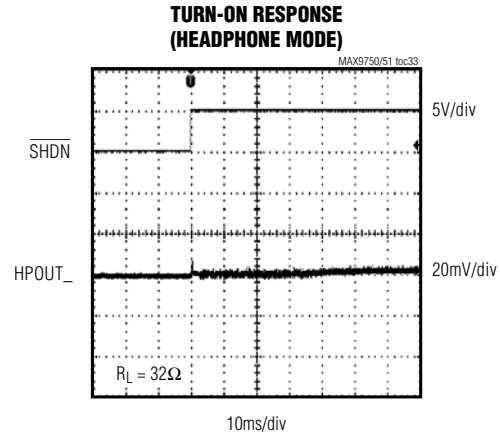
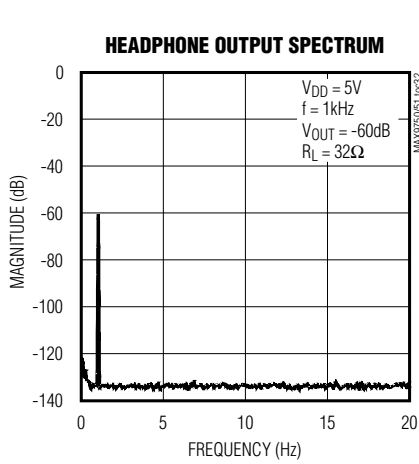

# 2.6W Stereo Audio Power Amplifiers and DirectDrive Headphone Amplifiers

## Pin Description

MAX9750/MAX9751/MAX9755

PIN			NAME	FUNCTION
MAX9750	MAX9751	MAX9755		
1	—	2	INL	Left-Channel Audio Input
2	—	—	BEEP	Audible Alert Beep Input
3, 19	3, 19	3, 19	PGND	Power Ground. Connect PGND to GND at a single point on the PCB near the device.
4	4	4	OUTL+	Left-Channel Positive Speaker Output
5	5	5	OUTL-	Left-Channel Negative Speaker Output
6, 16	6, 16	6, 16	PVDD	Speaker Amplifier Power Supply
7	7	7	CPVDD	Charge-Pump Power Supply
8	8	8	C1P	Charge-Pump Flying-Capacitor Positive Terminal
9	9	9	CPGND	Charge-Pump Ground. Connect CPGND to PGND.
10	10	10	C1N	Charge-Pump Flying-Capacitor Negative Terminal
11	11	11	CPVSS	Charge-Pump Output. Connect to VSS.
12	12	12	VSS	Headphone Amplifier Negative Power Supply
13	13	13	HPOUTR	Right-Channel Headphone Output
14	14	14	HPOUTL	Left-Channel Headphone Output
15	15	15	HPVDD	Headphone Positive Power Supply
17	17	17	OUTR-	Right-Channel Negative Speaker Output
18	18	18	OUTR+	Right-Channel Positive Speaker Output
20	20	20	HPS	Headphone Sense Input
21	21	21	BIAS	Common-Mode Bias Voltage. Bypass with a 1µF capacitor to GND.
22	22	22	$\overline{\text{SHDN}}$	Shutdown. Drive $\overline{\text{SHDN}}$ low to disable the device. Connect $\overline{\text{SHDN}}$ to VDD for normal operation.
23	—	—	GAIN2	Gain Control Input 2
24	—	—	GAIN1	Gain Control Input 1
25	25	25	VDD	Power Supply
26	26	23, 26	GND	Ground. Connect GND to PGND at a single point on the PCB near the device.
27	—	28	INR	Right-Channel Audio Input
28	—	—	VOL	Analog Volume Control Input
—	1	—	INL1	Left-Channel Audio Input 1
—	2	—	INL2	Left-Channel Audio Input 2
—	23	—	IN1/2	Input Select
—	24	24	GAIN	Gain Select
—	27	—	INR1	Right-Channel Audio Input 1
—	28	—	INR2	Right-Channel Audio Input 2
—	—	1, 27	N.C.	No Connection. Not internally connected.
—	—	1, 27	N.C.	No Connection. Not internally connected.
EP	EP	EP	EP	Exposed Paddle. Connect to GND.

## 2.6W Stereo Audio Power Amplifiers and DirectDrive Headphone Amplifiers

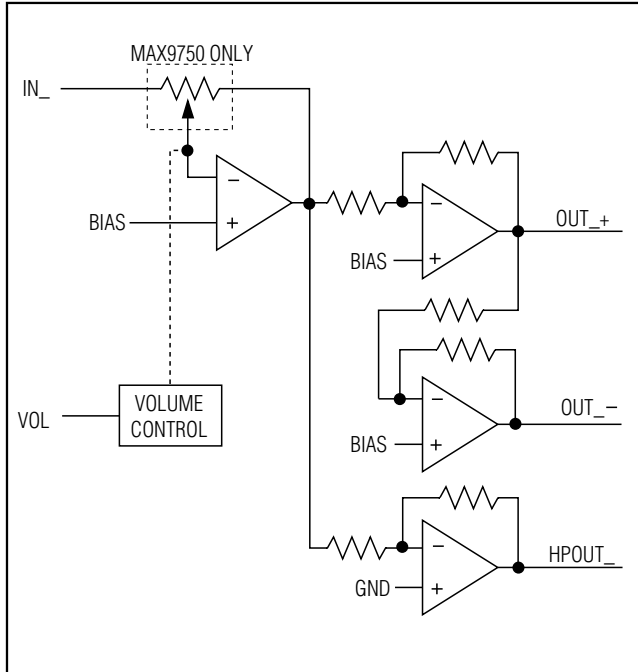

Figure 1. MAX9750/MAX9751 Signal Path

### Detailed Description

The MAX9750/MAX9751/MAX9755 combine a 2.6W BTL speaker amplifier and a 110mW DirectDrive headphone amplifier with integrated headphone sensing and comprehensive click-and-pop suppression. The MAX9750 features an analog volume control, BEEP input, and four-level gain control. The MAX9751 features a 2:1 input stereo multiplexer and two-level gain control. All devices feature high 90dB PSRR, low 0.01% THD+N, industry-leading click-and-pop performance, and a low-power shutdown mode.

Each signal path consists of an input amplifier that sets the gain of the signal path and feeds both the speaker and headphone amplifier (Figure 1). The speaker amplifier uses a BTL architecture, doubling the voltage drive to the speakers and eliminating the need for DC-blocking capacitors. The output consists of two signals, identical in magnitude, but 180° out of phase.

The headphone amplifiers use Maxim's DirectDrive architecture that eliminates the bulky output DC-blocking capacitors required by traditional headphone amplifiers. A charge pump inverts the positive supply (CPV<sub>DD</sub>), creating a negative supply (CPV<sub>SS</sub>). The headphone amplifiers operate from these bipolar supplies with their outputs biased about GND (Figure 2).

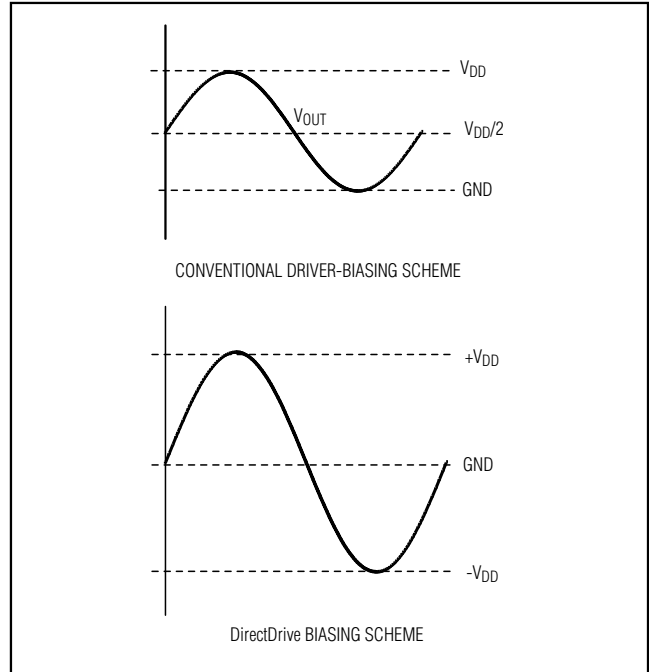

Figure 2. Traditional Headphone Amplifier Output Waveform vs. DirectDrive Headphone Amplifier Output Waveform

The amplifiers have almost twice the supply range compared to other single-supply amplifiers, nearly quadrupling the available output power. The benefit of the GND bias is that the amplifier outputs no longer have a DC component (typically  $V_{DD} / 2$ ). This eliminates the large DC-blocking capacitors required with conventional headphone amplifiers, conserving board space and system cost, and improving frequency response.

The MAX9750 features an analog volume control that varies the gain of the amplifiers based on the DC voltage applied at VOL. Both devices feature an undervoltage lockout that prevents operation from an insufficient power supply and click-and-pop suppression that eliminates audible transients on startup and shutdown. The amplifiers include thermal-overload and short-circuit protection, and can withstand  $\pm 8\text{kV}$  ESD strikes on the headphone amplifier outputs (IEC air discharge). An additional feature of the speaker amplifiers is that there is no phase inversion from input to output.

### DirectDrive

Conventional single-supply headphone amplifiers have their outputs biased about a nominal DC voltage (typically half the supply) for maximum dynamic range. Large coupling capacitors are needed to block this DC bias from the headphones. Without these capacitors, a

# 2.6W Stereo Audio Power Amplifiers and DirectDrive Headphone Amplifiers

MAX9750/MAX9751/MAX9755

significant amount of DC current flows to the headphone, resulting in unnecessary power dissipation and possible damage to both headphone and headphone amplifier.

Maxim's DirectDrive architecture uses a charge pump to an internal negative supply voltage. This allows the MAX9750/MAX9751/MAX9755 headphone amplifier output to be biased about GND, almost doubling the dynamic range while operating from a single supply. With no DC component, there is no need for the large DC-blocking capacitors. Instead of two large capacitors (220µF typ), the MAX9750/MAX9751/MAX9755 charge pump requires only two small ceramic capacitors (1µF typ), conserving board space, reducing cost, and improving the frequency response of the headphone amplifier. See the Output Power vs. Charge-Pump Capacitance and Load Resistance graph in the *Typical Operating Characteristics* for details of the possible capacitor values.

Previous attempts to eliminate the output coupling capacitors involved biasing the headphone return (sleeve) to the DC bias voltage of the headphone amplifiers. This method raised some issues:

- 1) The sleeve is typically grounded to the chassis. Using this biasing approach, the sleeve must be isolated from system ground, complicating product design.
- 2) During an ESD strike, the amplifier's ESD structures are the only path to system ground. The amplifier must be able to withstand the full ESD strike.
- 3) When using the headphone jack as a lineout to other equipment, the bias voltage on the sleeve may conflict with the ground potential from other equipment, resulting in large ground-loop current and possible damage to the amplifiers.

### Low-Frequency Response

In addition to the cost and size disadvantages, the DC-blocking capacitors limit the low-frequency response of the amplifier and distort the audio signal:

- 1) The impedance of the headphone load to the DC-blocking capacitor forms a highpass filter with the -3dB point determined by:

$$f_{-3dB} = \frac{1}{2\pi R_L C_{OUT}}$$

where  $R_L$  is the impedance of the headphone and  $C_{OUT}$  is the value of the DC-blocking capacitor.

The highpass filter is required by conventional single-ended, single-supply headphone amplifiers to block the midrail DC component of the audio signal from the headphones. Depending on the -3dB point,

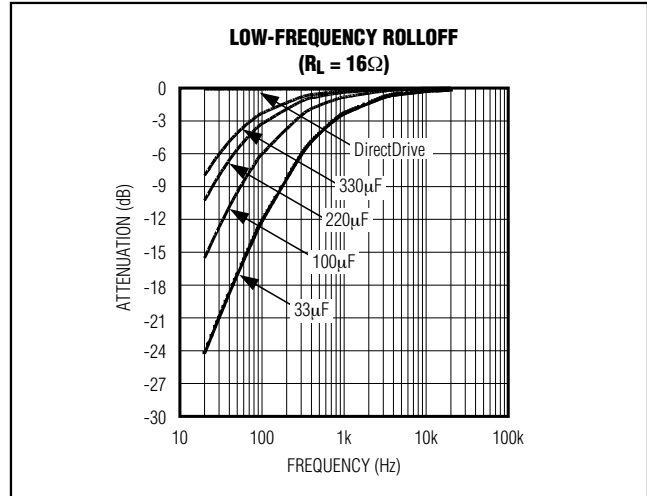

Figure 3. Low-Frequency Attenuation of Common DC-Blocking Capacitor Values

the filter can attenuate low-frequency signals within the audio band. Larger values of  $C_{OUT}$  reduce the attenuation but are physically larger, more expensive capacitors. Figure 3 shows the relationship between the size of  $C_{OUT}$  and the resulting low-frequency attenuation. Note that the -3dB point for a 16Ω headphone with a 100µF blocking capacitor is 100Hz, well within the audio band.

- 2) The voltage coefficient of the capacitor, the change in capacitance due to a change in the voltage across the capacitor, distorts the audio signal. At frequencies around the -3dB point, the reactance of the capacitor dominates, and the voltage coefficient appears as frequency-dependent distortion. Figure 4 shows the THD+N introduced by two different capacitor dielectrics. Note that around the -3dB point, THD+N increases dramatically.

The combination of low-frequency attenuation and frequency-dependent distortion compromises audio reproduction. DirectDrive improves low-frequency reproduction in portable audio equipment that emphasizes low-frequency effects such as multimedia laptops, and MP3, CD, and DVD players.

### Charge Pump

The MAX9750/MAX9751/MAX9755 feature a low-noise charge pump. The 550kHz switching frequency is well beyond the audio range, and does not interfere with the audio signals. The switch drivers feature a controlled switching speed that minimizes noise generated by turn-on and turn-off transients. Limiting the switching speed of the charge pump minimizes the di/dt noise caused by the

## 2.6W Stereo Audio Power Amplifiers and DirectDrive Headphone Amplifiers

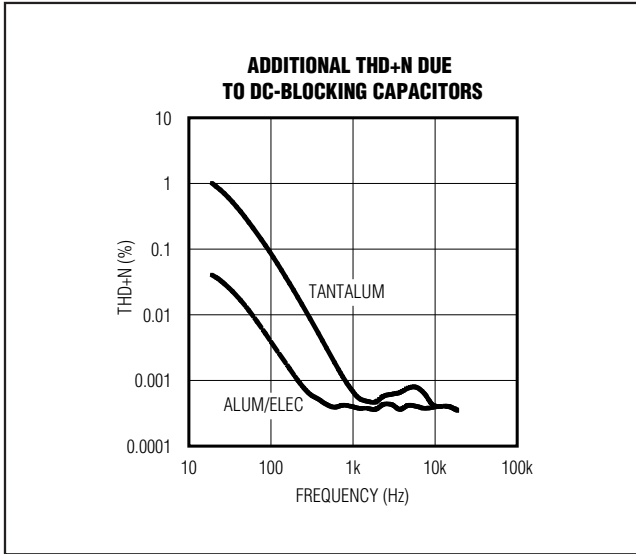

Figure 4. Distortion Contributed by DC-Blocking Capacitors

parasitic bond wire and trace inductance. Although not typically required, additional high-frequency ripple attenuation can be achieved by increasing the size of C2 (see the *Block Diagrams*).

### Headphone Sense Input (HPS)

The headphone sense input (HPS) monitors the headphone jack and automatically configures the device based upon the voltage applied at HPS. A voltage of less than 0.8V sets the device to speaker mode. A voltage of greater than 2V disables the bridge amplifiers and enables the headphone amplifiers.

For automatic headphone detection, connect HPS to the control pin of a 3-wire headphone jack as shown in Figure 5. With no headphone present, the output impedance of the headphone amplifier pulls HPS low. When a headphone plug is inserted into the jack, the control pin is disconnected from the tip contact and HPS is pulled to V<sub>DD</sub> through a 10μA current source.

### BIAS

The MAX9750/MAX9751/MAX9755 feature an internally generated, power-supply independent, common-mode bias voltage of 1.8V referenced to GND. BIAS provides both click-and-pop suppression and sets the DC bias level for the amplifiers. Choose the value of the bypass capacitor as described in the *BIAS Capacitor* section. No external load should be applied to BIAS. Any load lowers the BIAS voltage, affecting the overall performance of the device.

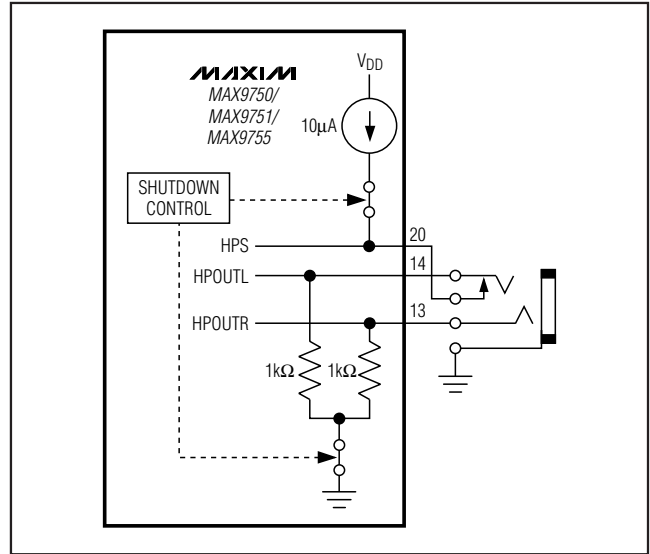

Figure 5. HPS Configuration

### Gain Selection

#### MAX9750

The MAX9750 features an internally set, selectable gain. The GAIN1 and GAIN2 inputs set the maximum gain of the MAX9750 speaker and headphone amplifiers (Table 1). The gain of the device can vary based upon the voltage at VOL (see the *Analog Volume Control (VOL)* section). However, the maximum gain cannot be exceeded.

#### MAX9751/MAX9755

The gain of the MAX9751/MAX9755 is set by the GAIN input. Driving GAIN high sets the gain of the speaker amplifiers to 9dB and the gain of the headphone amplifiers to 0dB. Driving GAIN low sets the gain of the speaker amplifiers to 10.5dB, and the gain of the headphone amplifiers to 3dB (Table 2).

### Analog Volume Control (VOL)

The MAX9750 features an analog volume control that varies the gain of the device in 31 discrete steps based upon the DC voltage applied to VOL. The input range of V<sub>VOL</sub> is from 0 (full volume) to 0.858 x HPV<sub>DD</sub> (full mute), with example step sizes shown in Table 3. Connect the reference of the device driving VOL (Figure 6) to HPV<sub>DD</sub>. Since the volume control ADC is ratiometric to HPV<sub>DD</sub>, any changes in HPV<sub>DD</sub> are negated. The gain step sizes are not constant; the step sizes are 0.5dB/step at the upper extreme, 2dB/step in the midrange, and 4dB/step at the lower extreme. Figure 7 shows the transfer function of the volume control for a 3.3V supply.

# 2.6W Stereo Audio Power Amplifiers and DirectDrive Headphone Amplifiers

MAX9750/MAX9751/MAX9755

**Table 1. MAX9750 Maximum Gain Settings**

GAIN2	GAIN1	SPEAKER MODE GAIN (dB)			HEADPHONE MODE GAIN (dB)
		MAX9750A	MAX9750B	MAX9750C	
0	0	9	15	6	0
0	1	10.5	16.5	7.5	0
1	0	12	18	9	3
1	1	13.5	19.5	10.5	3

**Table 2. MAX9751/MAX9755 Gain Settings**

GAIN	SPEAKER MODE GAIN (dB)	HEADPHONE MODE GAIN (dB)
0	10.5	3
1	9	0

### BEEP Input

The MAX9750 features an audible alert beep input (BEEP) that accepts a mono system alert signal and mixes it into the stereo audio path. When the amplitude of  $V_{BEEP(OUT)}$  exceeds  $800mV_{P-P}$  (Figure 8) and the frequency of the beep signal is greater than 300Hz, the beep signal is mixed into the active audio path (speaker or headphone). If the signal at  $V_{BEEP(OUT)}$  is either  $< 800mV_{P-P}$  or  $< 300Hz$ , the BEEP signal is not mixed into the audio path. The amplitude of the BEEP signal at the device output is roughly the amplitude of  $V_{BEEP(OUT)}$  times the gain of the selected signal path.

The input resistor ( $R_B$ ) sets the gain of the BEEP input amplifier, and thus the amplitude of  $V_{BEEP(OUT)}$ . Choose  $R_B$  based on:

$$R_B \leq \frac{V_{IN} \times R_{INT}}{0.3}$$

where  $R_{INT}$  is the value of the BEEP amplifier feedback resistor ( $47k\Omega$ ) and  $V_{IN}$  is the BEEP input amplitude. Note that the BEEP amplifier can be set up as either an attenuator, if the original alert signal amplitude is too large, or set to gain up the alert signal if it is below  $800mV_{P-P}$ . AC couple the alert signal to BEEP. Choose the value of the coupling capacitor as described in the *Input Filtering* section. Multiple beep inputs can be summed (Figure 8).

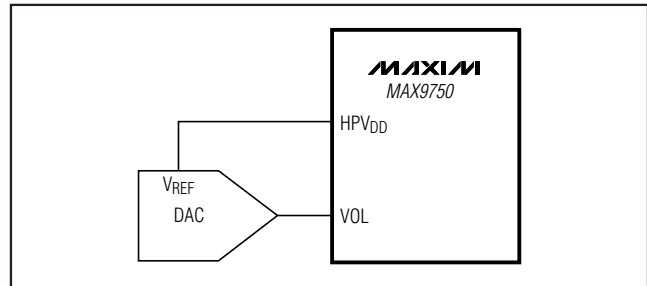

Figure 6. Volume Control Circuit

### Input Multiplexer

The MAX9751 features a 2:1 input multiplexer on each amplifier, allowing input selection between two stereo sources. The logic input  $IN1/\bar{2}$  controls both multiplexers. A logic high selects input  $IN_1$  and a logic low selects input  $IN_2$ .

### Shutdown

The MAX9750/MAX9751/MAX9755 features a  $0.2\mu A$ , low-power shutdown mode that reduces quiescent current consumption and extends battery life. Driving  $\overline{SHDN}$  low disables the drive amplifiers, bias circuitry, and charge pump, and drives BIAS and all outputs to GND. Connect  $\overline{SHDN}$  to  $V_{DD}$  for normal operation.

### Click-and-Pop Suppression

#### Speaker Amplifier

The MAX9750/MAX9751/MAX9755 speaker amplifiers feature Maxim's comprehensive, industry-leading click-and-pop suppression. During startup, the click-pop suppression circuitry eliminates any audible transient sources internal to the device. When entering shutdown, both amplifier outputs ramp to GND quickly and simultaneously.



## 2.6W Stereo Audio Power Amplifiers and DirectDrive Headphone Amplifiers

Table 3A. MAX9750A Volume Levels

Vvol (V)			SPEAKER MODE GAIN (dB)				HEADPHONE MODE GAIN (dB)	
V <sub>MIN</sub> *	V <sub>MAX</sub> *	HPV <sub>DD</sub> *	GAIN1 = 0, GAIN2 = 0	GAIN1 = 1, GAIN2 = 0	GAIN1 = 0, GAIN2 = 1	GAIN1 = 1 GAIN2 = 1	GAIN1 = X, GAIN2 = 0	GAIN1 = X, GAIN2 = 1
0	0.49	0.074	9	10.5	12	13.5	0	3
0.49	0.5673	0.160	8	10	11.5	13	-1	2.5
0.5673	0.6447	0.183	7	9	11	12.5	-2	2
0.6447	0.722	0.207	6	8	10.5	12	-3	1.5
0.722	0.7994	0.230	4	7	10	11.5	-5	1
0.7994	0.8767	0.253	2	6	9	11	-7	0
0.8767	0.9541	0.277	0	4	8	10.5	-9	-1
0.9541	1.0314	0.300	-2	2	7	10	-11	-2
1.0314	1.1088	0.324	-4	0	6	9	-13	-3
1.1088	1.1861	0.347	-6	-2	4	8	-15	-5
1.1861	1.2635	0.371	-8	-4	2	7	-17	-7
1.2635	1.3408	0.394	-10	-6	0	6	-19	-9
1.3408	1.4182	0.418	-12	-8	-2	4	-21	-11
1.4182	1.4955	0.441	-14	-10	-4	2	-23	-13
1.4955	1.5728	0.464	-16	-12	-6	0	-25	-15
1.5728	1.6502	0.488	-18	-14	-8	-2	-27	-17
1.6502	1.7275	0.511	-20	-16	-10	-4	-29	-19
1.7275	1.8049	0.535	-22	-18	-12	-6	-31	-21
1.8049	1.8822	0.558	-24	-20	-14	-8	-33	-23
1.8822	1.9596	0.582	-26	-22	-16	-10	-35	-25
1.9596	2.0369	0.605	-28	-24	-18	-12	-37	-27
2.0369	2.1143	0.628	-30	-26	-20	-14	-39	-29
2.1143	2.1916	0.652	-32	-28	-22	-16	-41	-31
2.1916	2.269	0.675	-34	-30	-24	-18	-43	-33
2.269	2.3463	0.699	-38	-32	-26	-20	-47	-35
2.3463	2.4237	0.722	-42	-34	-28	-22	-51	-37
2.4237	2.501	0.746	-46	-38	-30	-24	-55	-39
2.501	2.5783	0.769	-50	-42	-32	-26	-59	-41
2.5783	2.6557	0.793	-54	-46	-34	-28	-63	-43
2.6557	2.733	0.816	-58	-50	-38	-30	-67	-47
2.733	2.8104	0.839	-62	-54	-42	-32	-71	-51
2.8104	3.3	0.858	MUTE	MUTE	MUTE	MUTE	MUTE	MUTE

\*Based on HPV<sub>DD</sub> = 3.3V

X = Don't care.



## 2.6W Stereo Audio Power Amplifiers and DirectDrive Headphone Amplifiers

**MAX9750/MAX9751/MAX9755**

**Table 3B. MAX9750B Volume Levels**

V <sub>oL</sub> (V)			SPEAKER MODE GAIN (dB)				HEADPHONE MODE GAIN (dB)	
V <sub>MIN</sub> *	V <sub>MAX</sub> *	HPV <sub>DD</sub> *	GAIN1 = 0, GAIN2 = 0	GAIN1 = 1, GAIN2 = 0	GAIN1 = 0, GAIN2 = 1	GAIN1 = 1 GAIN2 = 1	GAIN1 = X, GAIN2 = 0	GAIN1 = X, GAIN2 = 1
0	0.49	0.074	15	16.5	18	19.5	0	3
0.49	0.5673	0.160	14	16	17.5	19	-1	2.5
0.5673	0.6447	0.183	13	15	17	18.5	-2	2
0.6447	0.722	0.207	12	14	16.5	18	-3	1.5
0.722	0.7994	0.230	10	13	16	17.5	-5	1
0.7994	0.8767	0.253	8	12	15	17	-7	0
0.8767	0.9541	0.277	6	10	14	16.5	-9	-1
0.9541	1.0314	0.300	4	8	13	16	-11	-2
1.0314	1.1088	0.324	2	6	12	15	-13	-3
1.1088	1.1861	0.347	0	4	10	14	-15	-5
1.1861	1.2635	0.371	-2	2	8	13	-17	-7
1.2635	1.3408	0.394	-4	0	6	12	-19	-9
1.3408	1.4182	0.418	-6	-2	4	10	-21	-11
1.4182	1.4955	0.441	-8	-4	2	8	-23	-13
1.4955	1.5728	0.464	-10	-6	0	6	-25	-15
1.5728	1.6502	0.488	-12	-8	-2	4	-27	-17
1.6502	1.7275	0.511	-14	-10	-4	2	-29	-19
1.7275	1.8049	0.535	-16	-12	-6	0	-31	-21
1.8049	1.8822	0.558	-18	-14	-8	-2	-33	-23
1.8822	1.9596	0.582	-20	-16	-10	-4	-35	-25
1.9596	2.0369	0.605	-22	-18	-12	-6	-37	-27
2.0369	2.1143	0.628	-24	-20	-14	-8	-39	-29
2.1143	2.1916	0.652	-26	-22	-16	-10	-41	-31
2.1916	2.269	0.675	-28	-24	-18	-12	-43	-33
2.269	2.3463	0.699	-32	-26	-20	-14	-47	-35
2.3463	2.4237	0.722	-36	-28	-22	-16	-51	-37
2.4237	2.501	0.746	-40	-32	-24	-18	-55	-39
2.501	2.5783	0.769	-44	-36	-26	-20	-59	-41
2.5783	2.6557	0.793	-48	-40	-28	-22	-63	-43
2.6557	2.733	0.816	-52	-44	-32	-24	-67	-47
2.733	2.8104	0.839	-56	-48	-36	-26	-71	-51
2.8104	3.3	0.858	MUTE	MUTE	MUTE	MUTE	MUTE	MUTE

\*Based on HPV<sub>DD</sub> = 3.3V  
X = Don't care.

## 2.6W Stereo Audio Power Amplifiers and DirectDrive Headphone Amplifiers

Table 3C. MAX9750C Volume Levels

V <sub>VoL</sub> (V)			SPEAKER MODE GAIN (dB)				HEADPHONE MODE GAIN (dB)	
V <sub>MIN</sub> *	V <sub>MAX</sub> *	HPV <sub>DD</sub> *	GAIN1 = 0, GAIN2 = 0	GAIN1 = 1, GAIN2 = 0	GAIN1 = 0, GAIN2 = 1	GAIN1 = 1 GAIN2 = 1	GAIN1 = X, GAIN2 = 0	GAIN1 = X, GAIN2 = 1
0	0.49	0.074	6	7.5	9	10.5	0	3
0.49	0.5673	0.160	5	7	8.5	10	-1	2.5
0.5673	0.6447	0.183	4	6	8	9.5	-2	2
0.6447	0.722	0.207	3	5	7.5	9	-3	1.5
0.722	0.7994	0.230	1	4	7	8.5	-5	1
0.7994	0.8767	0.253	-1	3	6	8	-7	0
0.8767	0.9541	0.277	-3	1	5	7.5	-9	-1
0.9541	1.0314	0.300	-5	-1	4	7	-11	-2
1.0314	1.1088	0.324	-7	-3	3	6	-13	-3
1.1088	1.1861	0.347	-9	-5	1	5	-15	-5
1.1861	1.2635	0.371	-11	-7	-1	4	-17	-7
1.2635	1.3408	0.394	-13	-9	-3	3	-19	-9
1.3408	1.4182	0.418	-15	-11	-5	1	-21	-11
1.4182	1.4955	0.441	-17	-13	-7	-1	-23	-13
1.4955	1.5728	0.464	-19	-15	-9	-3	-25	-15
1.5728	1.6502	0.488	-21	-17	-11	-5	-27	-17
1.6502	1.7275	0.511	-23	-19	-13	-7	-29	-19
1.7275	1.8049	0.535	-25	-21	-15	-9	-31	-21
1.8049	1.8822	0.558	-27	-23	-17	-11	-33	-23
1.8822	1.9596	0.582	-29	-25	-9	-13	-35	-25
1.9596	2.0369	0.605	-31	-27	-21	-15	-37	-27
2.0369	2.1143	0.628	-33	-29	-23	-17	-39	-29
2.1143	2.1916	0.652	-35	-31	-2	-19	-41	-31
2.1916	2.269	0.675	-37	-3	-27	-21	-43	-33
2.269	2.3463	0.699	-41	-35	-29	-23	-47	-35
2.3463	2.4237	0.722	-45	-37	-31	-25	-51	-37
2.4237	2.501	0.746	-48	-41	-33	-27	-55	-39
2.501	2.5783	0.769	-53	-45	-35	-29	-59	-41
2.5783	2.6557	0.793	-57	-49	-37	-31	-63	-43
2.6557	2.733	0.816	-61	-53	-41	-33	-67	-47
2.733	2.8104	0.839	-65	-57	-45	-35	-71	-51
2.8104	3.3	0.858	MUTE	MUTE	MUTE	MUTE	MUTE	MUTE

\*Based on HPV<sub>DD</sub> = 3.3V

X = Don't care.

# 2.6W Stereo Audio Power Amplifiers and DirectDrive Headphone Amplifiers

MAX9750/MAX9751/MAX9755

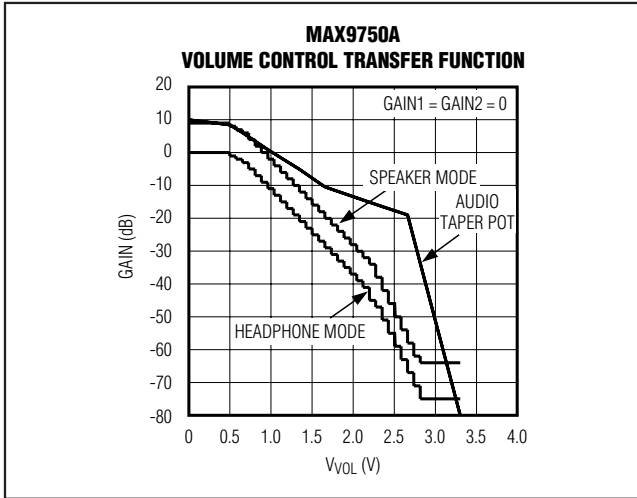

Figure 7a. Volume Control Transfer Function

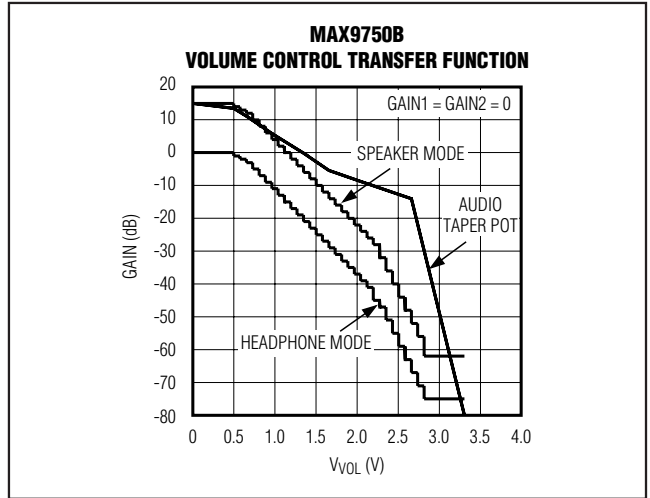

Figure 7b. Volume Control Transfer Function

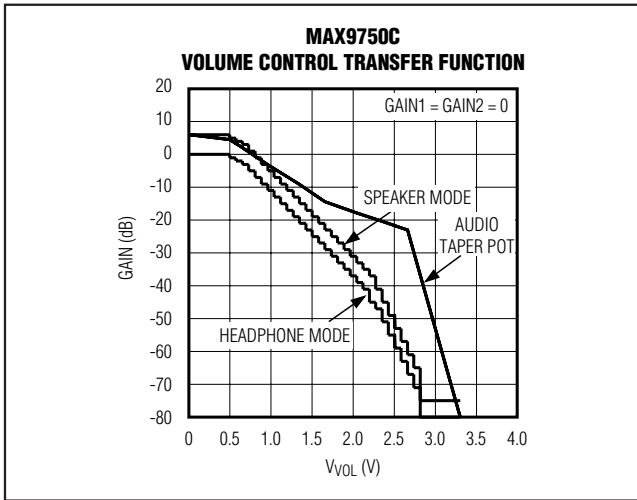

Figure 7c. Volume Control Transfer Function

### Headphone Amplifier

In conventional single-supply headphone amplifiers, the output-coupling capacitor is a major contributor of audible clicks and pops. Upon startup, the amplifier charges the coupling capacitor to its bias voltage, typically half the supply. Likewise, during shutdown, the capacitor is discharged to GND. A DC shift across the capacitor results, which in turn appears as an audible transient at the speaker. Since the MAX9750/MAX9751/MAX9755 do not require output-coupling capacitors, no audible transient occurs.

Additionally, the MAX9750/MAX9751/MAX9755 features extensive click-and-pop suppression that eliminates any audible transient sources internal to the device. The Turn-On Response (Headphone Mode) and Turn-Off Response (Headphone Mode) graphs in the *Typical Operating Characteristics* shows that there are minimal transient components in the audible range at the output upon startup and shutdown.

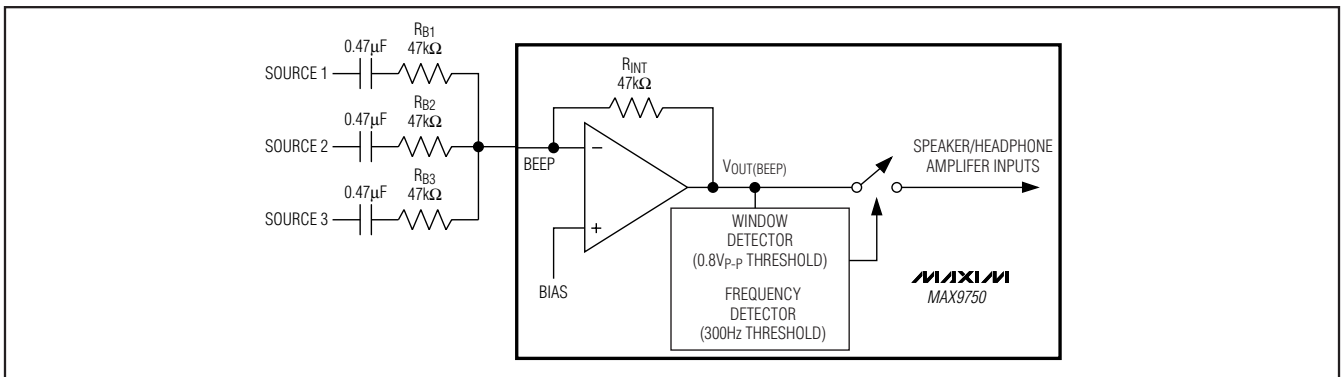

Figure 8. BEEP Input

## 2.6W Stereo Audio Power Amplifiers and DirectDrive Headphone Amplifiers

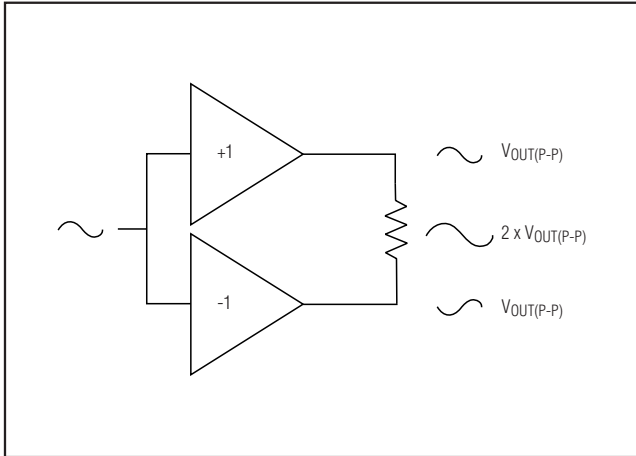

Figure 9. Bridge-Tied Load Configuration

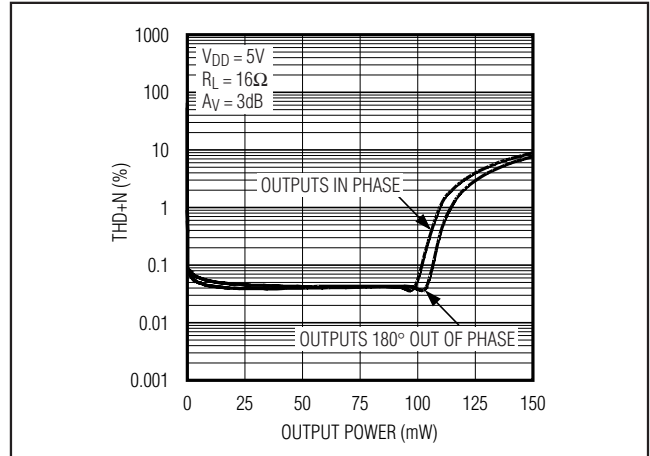

Figure 10. Total Harmonic Distortion Plus Noise vs. Output Power with Inputs In/Out of Phase (Headphone Mode)

### Applications Information

#### BTL Speaker Amplifiers

The MAX9750/MAX9751/MAX9755 feature speaker amplifiers designed to drive a load differentially, a configuration referred to as bridge-tied load (BTL). The BTL configuration (Figure 9) offers advantages over the single-ended configuration, where one side of the load is connected to ground. Driving the load differentially doubles the output voltage compared to a single-ended amplifier under similar conditions. Thus, the device's differential gain is twice the closed-loop gain of the input amplifier. The effective gain is given by:

$$A_{VD} = 2 \times \frac{R_F}{R_{IN}}$$

Substituting  $2 \times V_{OUT(P-P)}$  into the following equation yields four times the output power due to double the output voltage:

$$V_{RMS} = \frac{V_{OUT(P-P)}}{2\sqrt{2}}$$

$$P_{OUT} = \frac{V_{RMS}^2}{R_L}$$

Since the differential outputs are biased at midsupply, there is no net DC voltage across the load. This eliminates the need for DC-blocking capacitors required for single-ended amplifiers. These capacitors can be large and expensive, can consume board space, and can degrade low-frequency performance.

#### Power Dissipation and Heat Sinking

Under normal operating conditions, the MAX9750/MAX9751/MAX9755 can dissipate a significant amount of power. The maximum power dissipation for each package is given in the *Absolute Maximum Ratings* under Continuous Power Dissipation, or can be calculated by the following equation:

$$P_{DISSPKG(MAX)} = \frac{T_{J(MAX)} - T_A}{\theta_{JA}}$$

where  $T_{J(MAX)}$  is  $+150^{\circ}\text{C}$ ,  $T_A$  is the ambient temperature, and  $\theta_{JA}$  is the reciprocal of the derating factor in  $^{\circ}\text{C}/\text{W}$  as specified in the *Absolute Maximum Ratings* section. For example,  $\theta_{JA}$  of the thin QFN package is  $+42^{\circ}\text{C}/\text{W}$ . For optimum power dissipation, the exposed paddle of the package should be connected to the ground plane (see the *Layout and Grounding* section).

#### Output Power (Speaker Amplifier)

The increase in power delivered by the BTL configuration directly results in an increase in internal power dissipation over the single-ended configuration. The maximum power dissipation for a given  $V_{DD}$  and load is given by the following equation:

$$P_{DISS(MAX)} = \frac{2V_{DD}^2}{\pi^2 R_L}$$

If the power dissipation for a given application exceeds the maximum allowed for a given package, either reduce  $V_{DD}$ , increase load impedance, decrease the ambient temperature, or add heatsinking to the device. Large output, supply, and ground PC board traces improve the maximum power dissipation in the package.

# 2.6W Stereo Audio Power Amplifiers and DirectDrive Headphone Amplifiers

MAX9750/MAX9751/MAX9755

**Table 4. Suggested Capacitor Manufacturers**

SUPPLIER	PHONE	FAX	WEBSITE
Taiyo Yuden	800-348-2496	847-925-0899	www.t-yuden.com
TDK	807-803-6100	847-390-4405	www.component.tdk.com

Thermal-overload protection limits total power dissipation in these devices. When the junction temperature exceeds +160°C, the thermal-protection circuitry disables the amplifier output stage. The amplifiers are enabled once the junction temperature cools by 15°C. This results in a pulsing output under continuous thermal-overload conditions as the device heats and cools.

### Output Power (Headphone Amplifier)

The headphone amplifiers have been specified for the worst-case scenario—when both inputs are in phase. Under this condition, the drivers simultaneously draw current from the charge pump, leading to a slight loss in headroom of  $V_{SS}$ . In typical stereo audio applications, the left and right signals have differences in both magnitude and phase, subsequently leading to an increase in the maximum attainable output power. Figure 10 shows the two extreme cases for in and out of phase. In reality, the available power lies between these extremes.

### Power Supplies

The MAX9750/MAX9751/MAX9755 have different supplies for each portion of the device, allowing for the optimum combination of headroom and power dissipation and noise immunity. The speaker amplifiers are powered from  $PV_{DD}$ .  $PV_{DD}$  ranges from 4.5V to 5.5V. The headphone amplifiers are powered from  $HPV_{DD}$  and  $V_{SS}$ .  $HPV_{DD}$  is the positive supply of the headphone amplifiers and ranges from 3V to 5.5V.  $V_{SS}$  is the negative supply of the headphone amplifiers. Connect  $V_{SS}$  to  $CPV_{SS}$ . The charge pump is powered by  $CPV_{DD}$ .  $CPV_{DD}$  ranges from 3V to 5.5V and should be the same potential as  $HPV_{DD}$ . The charge pump inverts the voltage at  $CPV_{DD}$ , and the resulting voltage appears at  $CPV_{SS}$ . The remainder of the device is powered by  $V_{DD}$ .

### Component Selection

#### Input Filtering

The input capacitor ( $C_{IN}$ ), in conjunction with the amplifier input resistance ( $R_{IN}$ ), forms a highpass filter that removes the DC bias from an incoming signal (see the *Block Diagrams*). The AC-coupling capacitor allows the amplifier to bias the signal to an optimum DC level. Assuming zero source impedance, the -3dB point of the highpass filter is given by:

$$f_{-3dB} = \frac{1}{2\pi R_{IN} C_{IN}}$$

$R_{IN}$  is the amplifier's internal input resistance value given in the *Electrical Characteristics* table. Choose  $C_{IN}$  such that  $f_{-3dB}$  is well below the lowest frequency of interest. Setting  $f_{-3dB}$  too high affects the amplifier's low-frequency response. Use capacitors with low-voltage coefficient dielectrics, such as tantalum or aluminum electrolytic. Capacitors with high-voltage coefficients, such as ceramics, may result in increased distortion at low frequencies.

#### BIAS Capacitor

BIAS is the output of the internally generated DC bias voltage. The BIAS bypass capacitor,  $C_{BIAS}$ , improves PSRR and THD+N by reducing power supply and other noise sources at the common-mode bias node, and also generates the clickless/popless, startup/shutdown DC bias waveforms for the speaker amplifiers. Bypass BIAS with a 1 $\mu$ F capacitor to GND.

#### Charge-Pump Capacitor Selection

Use capacitors with an ESR less than 100m $\Omega$  for optimum performance. Low-ESR ceramic capacitors minimize the output resistance of the charge pump. For best performance over the extended temperature range, select capacitors with an X7R dielectric. Table 4 lists suggested manufacturers.

#### Flying Capacitor (C1)

The value of the flying capacitor ( $C1$ ) affects the load regulation and output resistance of the charge pump. A  $C1$  value that is too small degrades the device's ability to provide sufficient current drive, which leads to a loss of output voltage. Increasing the value of  $C1$  improves load regulation and reduces the charge-pump output resistance to an extent. See the Output Power vs. Charge-Pump Capacitance and Load Resistance graph in the *Typical Operating Characteristics*. Above 2.2 $\mu$ F, the on-resistance of the switches and the ESR of  $C1$  and  $C2$  dominate.

#### Output Capacitor (C2)

The output capacitor value and ESR directly affect the ripple at  $CPV_{SS}$ . Increasing the value of  $C2$  reduces output ripple. Likewise, decreasing the ESR of  $C2$

## 2.6W Stereo Audio Power Amplifiers and DirectDrive Headphone Amplifiers

reduces both ripple and output resistance. Lower capacitance values can be used in systems with low maximum output power levels. See the Output Power vs. Charge-Pump Capacitance and Load Resistance graph in the *Typical Operating Characteristics*.

### **CPVDD Bypass Capacitor (C3)**

The CPVDD bypass capacitor (C3) lowers the output impedance of the power supply and reduces the impact of the MAX9750/MAX9751/MAX9755's charge-pump switching transients. Bypass CPVDD with C3, the same value as C1, and place it physically close to CPVDD and PGND (refer to the MAX9750 Evaluation Kit for a suggested layout).

### **Powering Other Circuits from a Negative Supply**

An additional benefit of the MAX9750/MAX9751/MAX9755 is the internally generated negative supply voltage (CPVSS). CPVSS is used by the MAX9750/MAX9751/MAX9755 to provide the negative supply for the headphone amplifiers. It can also be used to power other devices within a design. Current draw from CPVSS should be limited to 5mA, exceeding this affects the operation of the headphone amplifier. A typical application is a negative supply to adjust the contrast of LCD modules.

When considering the use of CPVSS in this manner, note that the charge-pump voltage of CPVSS is roughly proportional to CPVDD and is not a regulated voltage. The charge-pump output impedance plot appears in the *Typical Operating Characteristics*.

### **Layout and Grounding**

Proper layout and grounding are essential for optimum performance. Use large traces for the power-supply inputs and amplifier outputs to minimize losses due to parasitic trace resistance, as well as route head away from the device. Good grounding improves audio performance, minimizes crosstalk between channels, and prevents any switching noise from coupling into the audio signal. Connect CPGND, PGND and GND

together at a single point on the PC board. Route CPGND and all traces that carry switching transients away from GND, PGND, and the traces and components in the audio signal path.

Connect all components associated with the charge pump (C2 and C3) to the CPGND plane. Connect VSS and CPVSS together at the device. Place the charge-pump capacitors (C1, C2, and C3) as close to the device as possible. Bypass HPVDD and PVDD with a 0.1 $\mu$ F capacitor to GND. Place the bypass capacitors as close to the device as possible.

Use large, low-resistance output traces. As load impedance decreases, the current drawn from the device outputs increase. At higher current, the resistance of the output traces decrease the power delivered to the load. For example, when compared to a 0 $\Omega$  trace, a 100m $\Omega$  trace reduces the power delivered to a 4 $\Omega$  load from 2.1W to 2W. Large output, supply, and GND traces also improve the power dissipation of the device.

The MAX9750/MAX9751/MAX9755 thin QFN package features an exposed thermal pad on its underside. This pad lowers the package's thermal resistance by providing a direct heat conduction path from the die to the printed circuit board. Connect the exposed thermal pad to GND by using a large pad and multiple vias to a GND plane on the bottom of the PCB.

## 2.6W Stereo Audio Power Amplifiers and DirectDrive Headphone Amplifiers

Simplified Block Diagrams (continued)

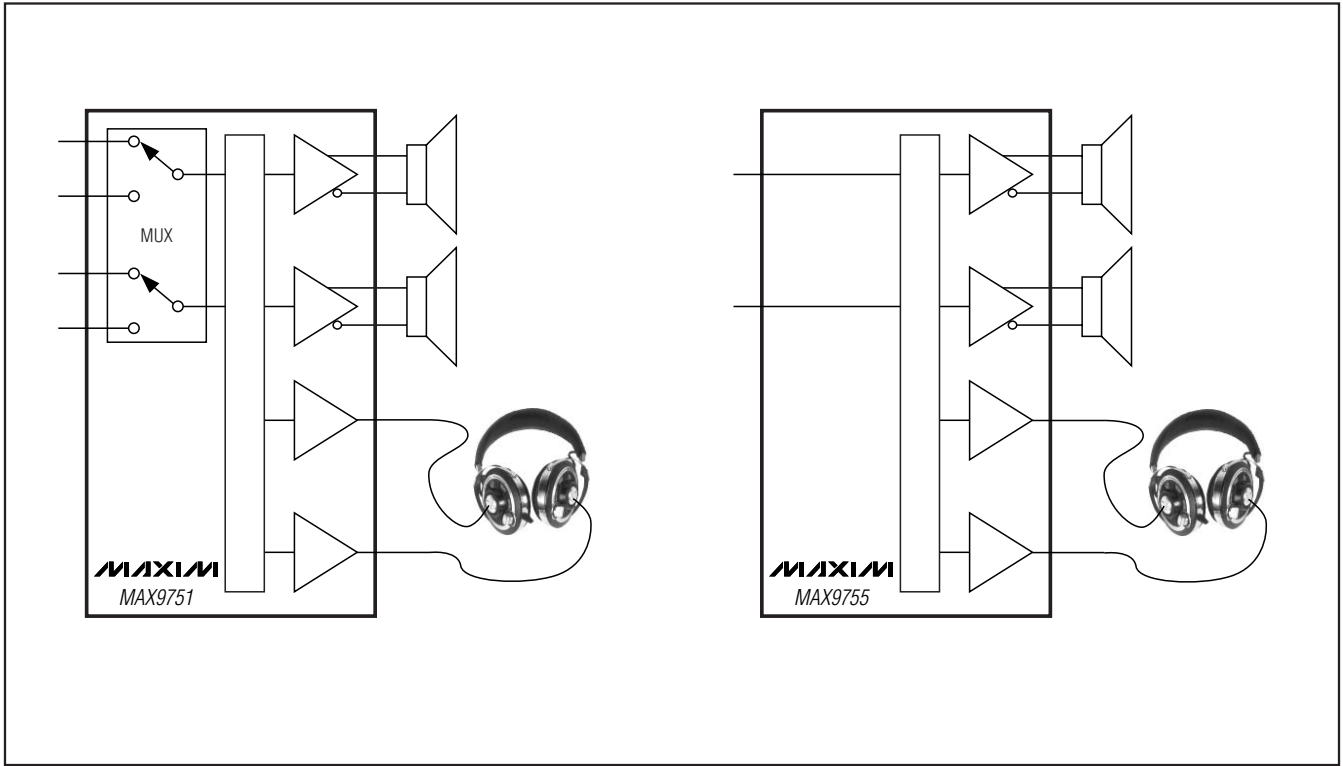

MAX9750/MAX9751/MAX9755

# 2.6W Stereo Audio Power Amplifiers and DirectDrive Headphone Amplifiers

## Block Diagrams

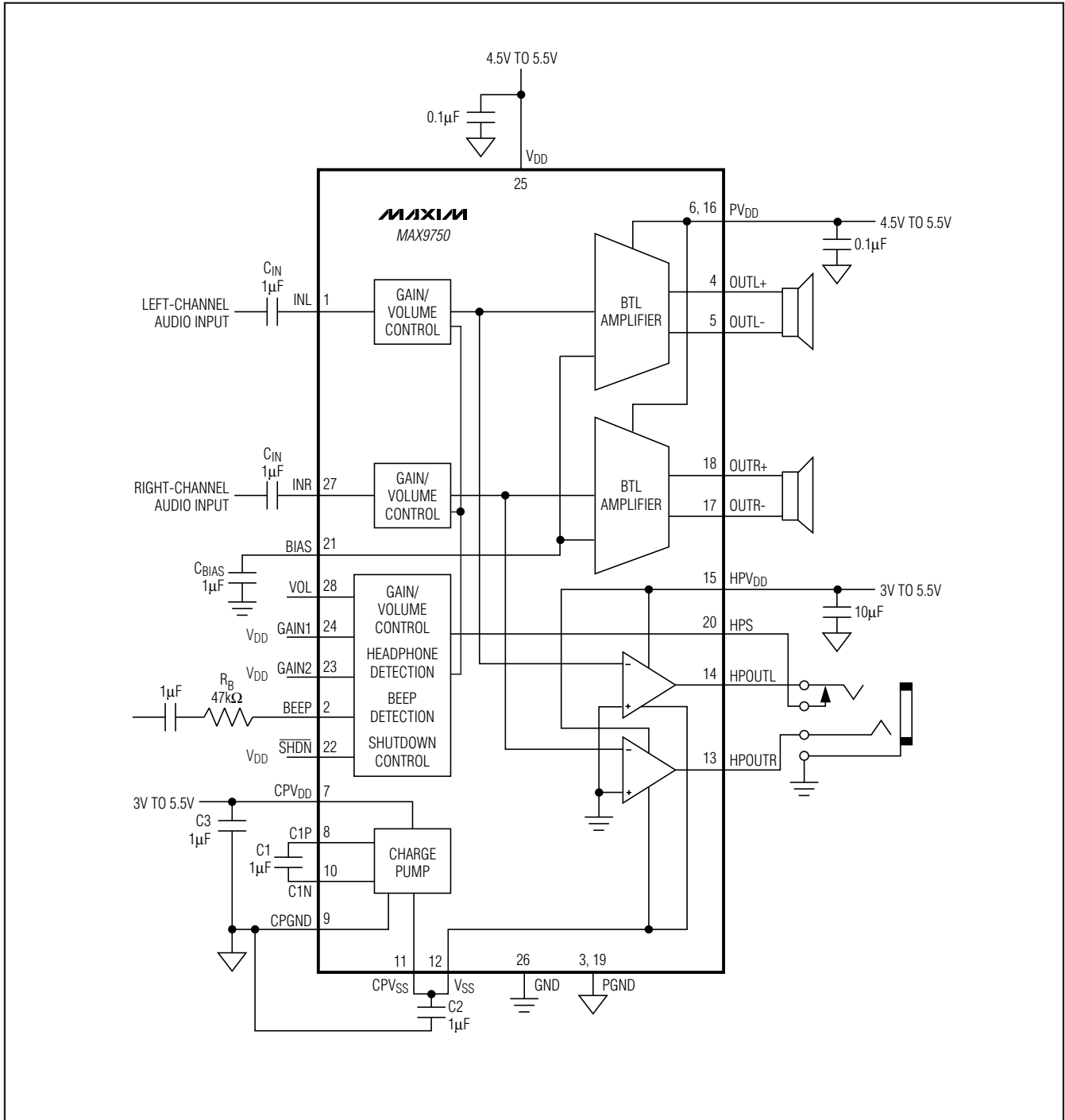



# 2.6W Stereo Audio Power Amplifiers and DirectDrive Headphone Amplifiers

Block Diagrams (continued)

MAX9750/MAX9751/MAX9755

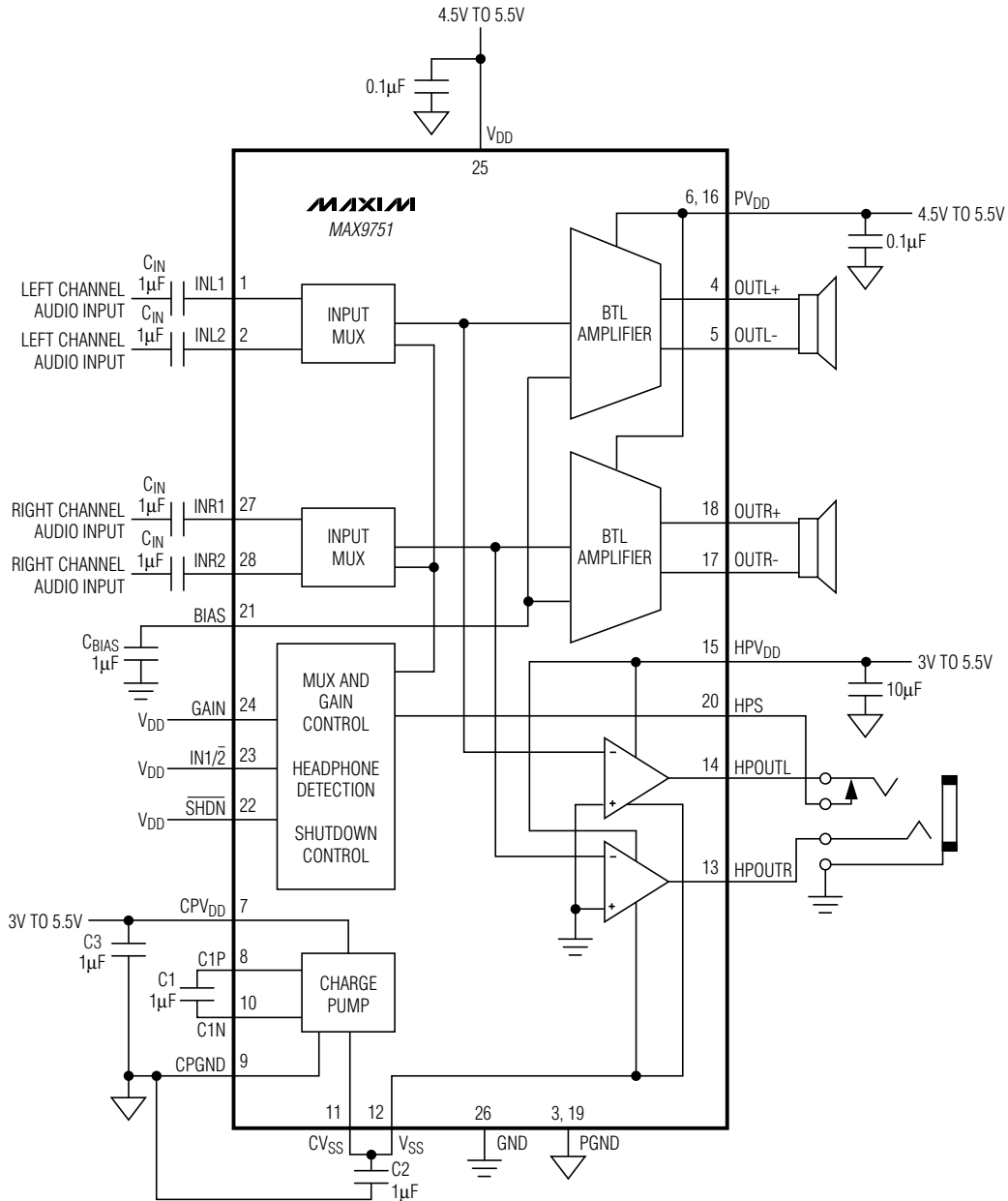

LOGIC PINS CONFIGURED FOR:  
 GAIN = 1, 9dB SPEAKER GAIN/0dB HEADPHONE GAIN.  
 IN1/2 = 1, SELECTED INPUT LINE 1.  
 SHDN = 1, PART ACTIVE.

# 2.6W Stereo Audio Power Amplifiers and DirectDrive Headphone Amplifiers

## Block Diagrams (continued)

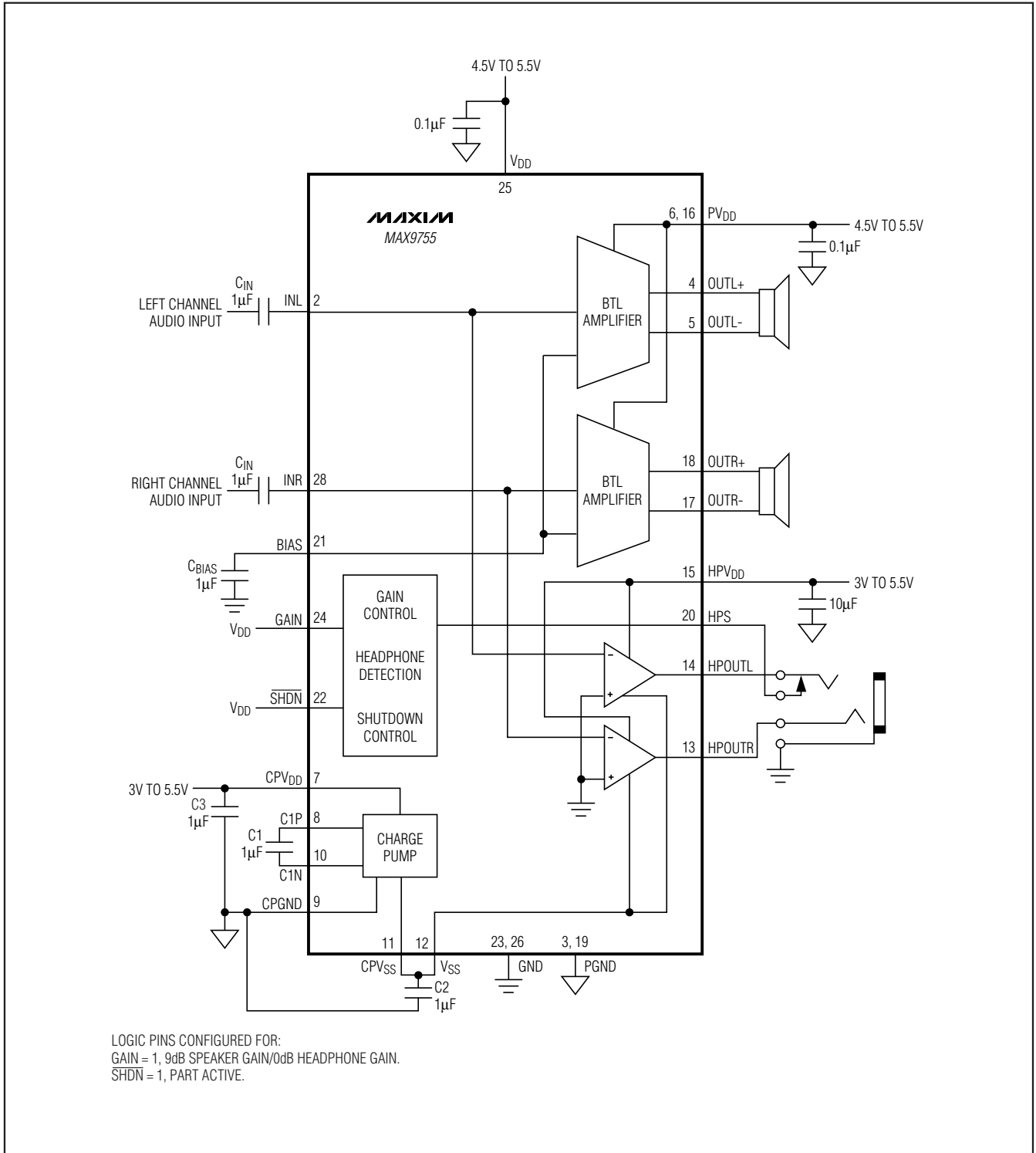

# 2.6W Stereo Audio Power Amplifiers and DirectDrive Headphone Amplifiers

## System Diagrams

MAX9750/MAX9751/MAX9755

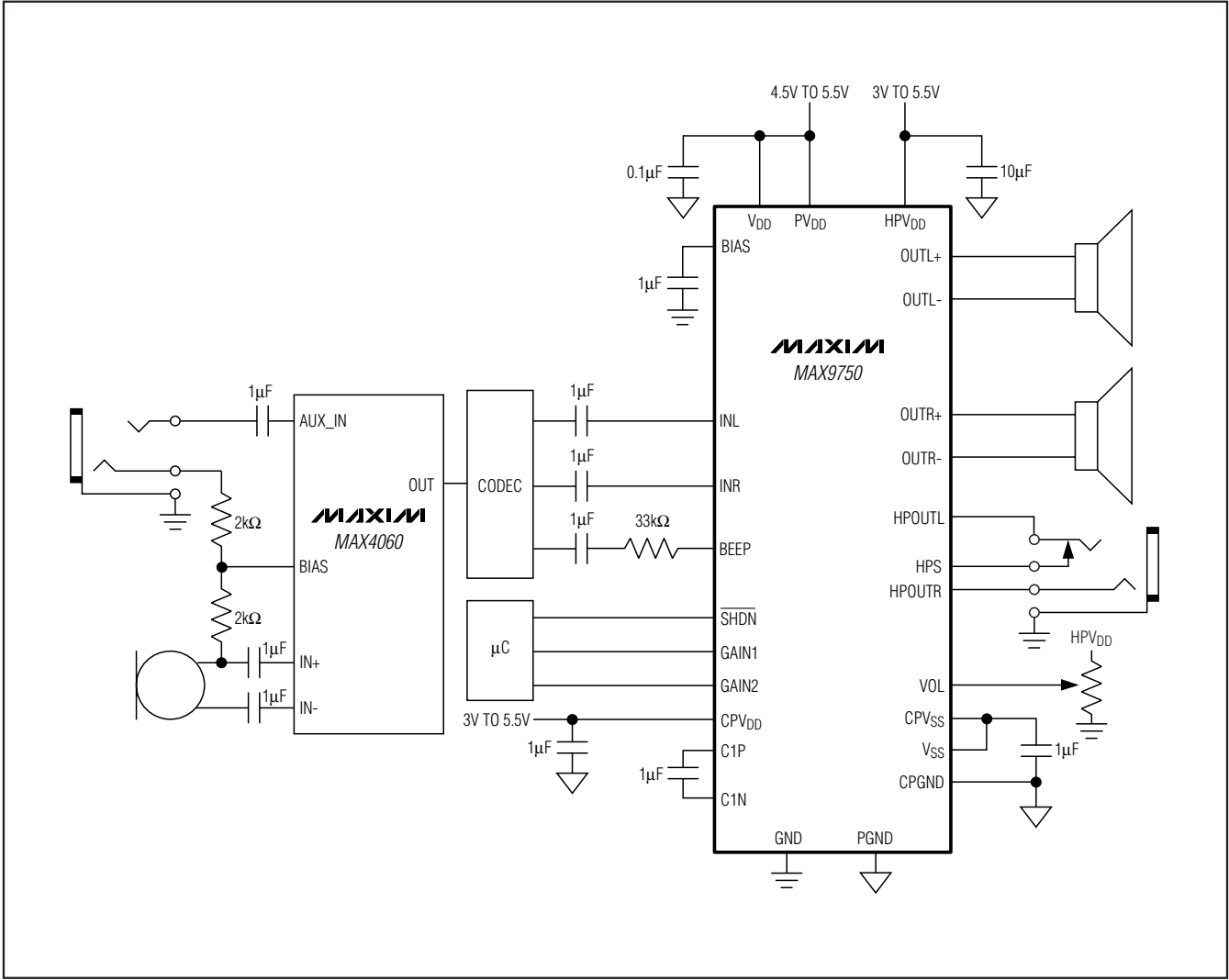

# 2.6W Stereo Audio Power Amplifiers and DirectDrive Headphone Amplifiers

## System Diagrams (continued)

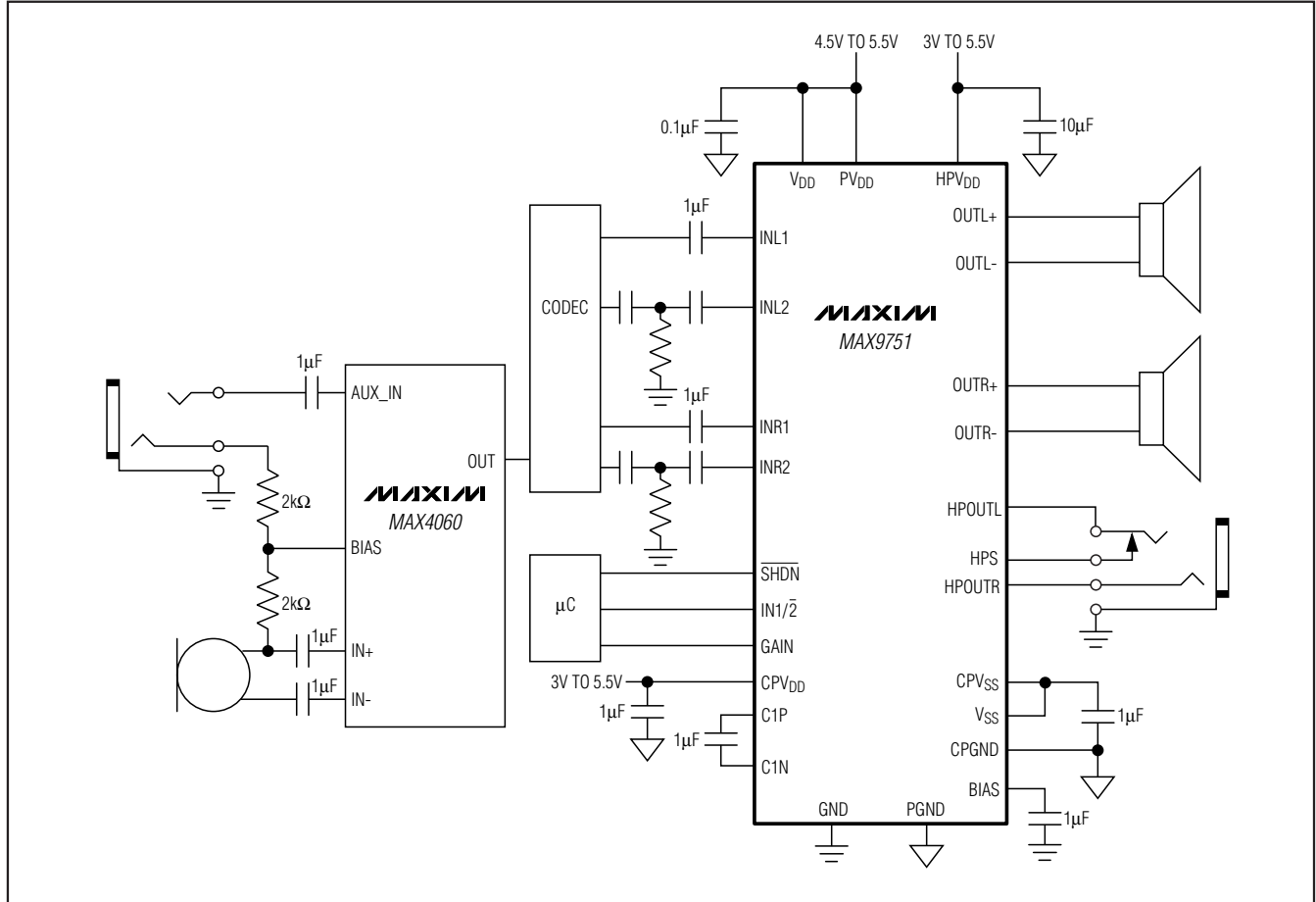

# 2.6W Stereo Audio Power Amplifiers and DirectDrive Headphone Amplifiers

## Pin Configurations

MAX9750/MAX9751/MAX9755

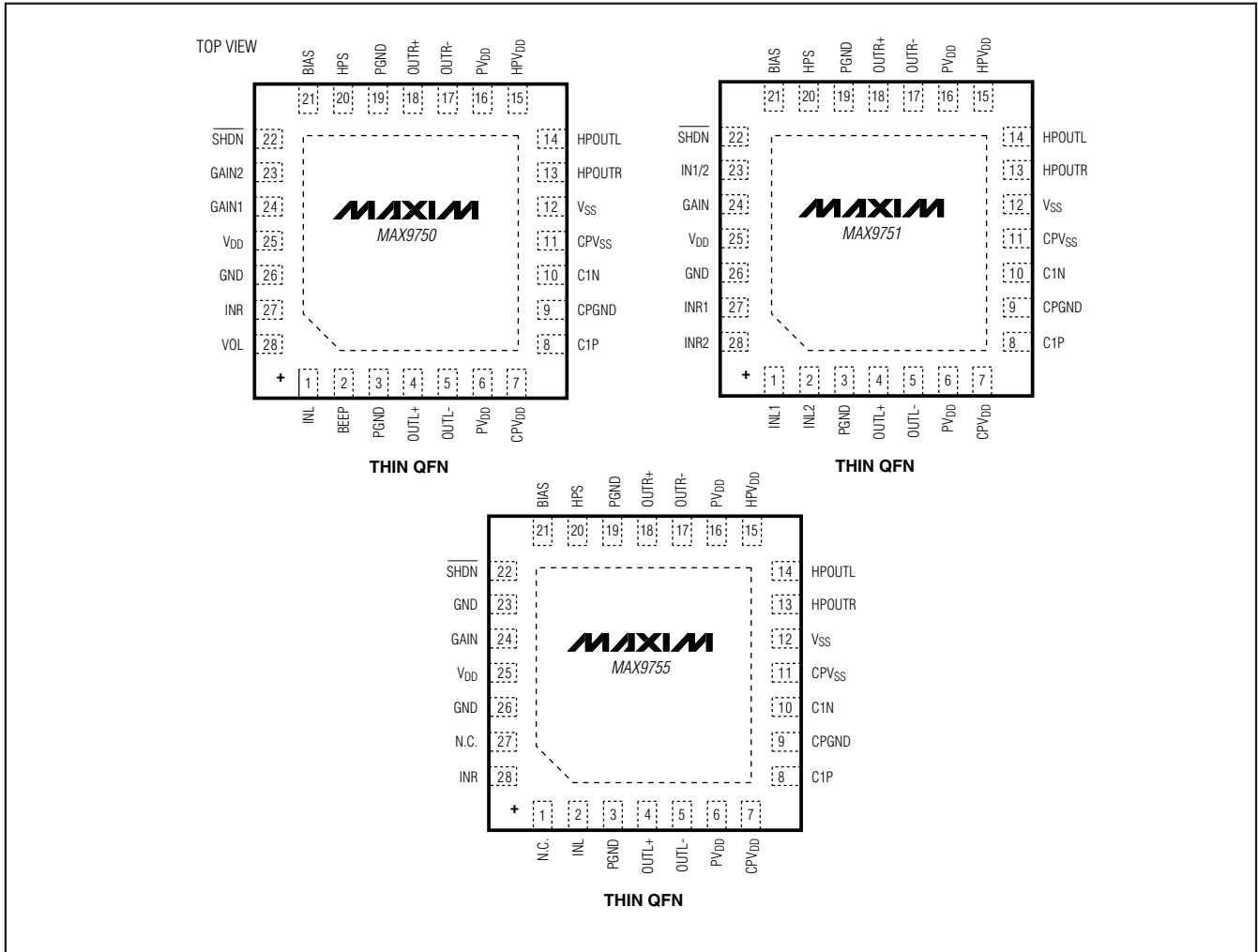

### Package Information

For the latest package outline information and land patterns, go to [www.maxim-ic.com/packages](http://www.maxim-ic.com/packages).

PACKAGE TYPE	PACKAGE CODE	DOCUMENT NO.
28 TQFN	T2855N-1	<a href="#">21-0140</a>

### Chip Information

PROCESS: BiCMOS

# **2.6W Stereo Audio Power Amplifiers and DirectDrive Headphone Amplifiers**

## **Revision History**

<b>REVISION NUMBER</b>	<b>REVISION DATE</b>	<b>DESCRIPTION</b>	<b>PAGES CHANGED</b>
8	6/08	Removed TSSOP package	1, 2, 11, 20, 24, 25, 26, 29

*Maxim cannot assume responsibility for use of any circuitry other than circuitry entirely embodied in a Maxim product. No circuit patent licenses are implied. Maxim reserves the right to change the circuitry and specifications without notice at any time.*

**30** \_\_\_\_\_ **Maxim Integrated Products, 120 San Gabriel Drive, Sunnyvale, CA 94086 408-737-7600**