

## SPDT High Isolation Terminated Switch 0.01- 4.0 GHz

Rev. V4

### Features

- Positive Voltage Control
- High Isolation:
  - 62 dB @ 1 GHz
  - 65 dB @ 2 GHz
- Low Insertion Loss:
  - 0.65 dB @ 1 GHz
  - 0.70 dB @ 2 GHz
- 50  $\Omega$  Internal Terminations
- Fast Settling for Low Gate Lag requirements
- Lead-Free MSOP-8-EP Package
- Halogen-Free “Green” Mold Compound
- RoHS\* Compliant and 260°C Reflow Compatible

### Description

The MASW-008543 GaAs monolithic switch provides high isolation in a lead-free, plastic surface mount package. This device is ideal for applications across a broad range of frequencies.

MACOM fabricates the MASW-008543 using a 0.5-micron gate length pHEMT process. The process features full chip passivation for performance and reliability.

### Ordering Information<sup>1,2</sup>

Part Number	Package
MASW-008543-000000	Bulk Packaging
MASW-008543-TR3000	3000 piece reel
MASW-008543-001SMB	Sample Board

1. Reference Application Note M513 for reel size information.
2. All sample boards include 5 loose parts.

### Functional Block Diagram

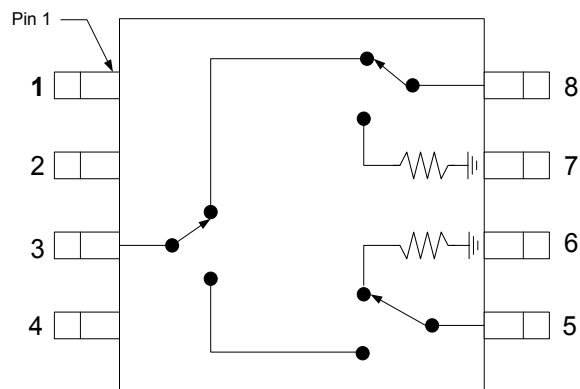

### Pin Configuration<sup>3</sup>

Pin	Function	Pin	Function
1	V1	5	RF Port 2
2	V2	6	Ground
3	RF Common	7	Ground
4	Ground	8	RF Port 1

3. The exposed pad centered on the package bottom must be connected to RF and DC ground.

### Handling Procedures

Please observe the following precautions to avoid damage:

### Static Sensitivity

Gallium Arsenide Integrated Circuits are sensitive to electrostatic discharge (ESD) and can be damaged by static electricity. Proper ESD control techniques should be used when handling these devices.

\* Restrictions on Hazardous Substances, European Union Directive 2011/65/EU.

## SPDT High Isolation Terminated Switch 0.01- 4.0 GHz

Rev. V4

### Electrical Specifications<sup>4</sup>: $T_A = 25^\circ\text{C}$ , $V_{\text{HIGH}} = 3\text{ V}$ , $V_{\text{LOW}} = 0\text{ V}$ , $Z_0 = 50\ \Omega$

Parameter	Test Conditions	Units	Min.	Typ.	Max.
Insertion Loss	1.0 GHz	dB	—	0.65	—
	2.0 GHz			0.70	0.95
	3.0 GHz			0.85	—
	4.0 GHz			1.10	—
Isolation	1.0 GHz	dB	—	62	—
	2.0 GHz		62	65	
	3.0 GHz		—	50	
	4.0 GHz		—	45	
Return Loss	0.5 - 4.0 GHz	dB	—	20	—
Input IP <sub>3</sub>	2-Tone, 2.1 GHz, 10 MHz spacing	dBm	—	53	—
P1dB	2.1 GHz, $V_{\text{HIGH}} = 3\text{ V}$	dBm	—	25	—
	2.1 GHz, $V_{\text{HIGH}} = 5\text{ V}$			30	
P0.1dB	2.1 GHz, $V_{\text{HIGH}} = 3\text{ V}$	dBm	—	20	—
	2.1 GHz, $V_{\text{HIGH}} = 5\text{ V}$			25	
T <sub>RISE</sub> , T <sub>FALL</sub>	10% to 90% RF & 90% to 10% RF	ns	—	30	—
T <sub>ON</sub> , T <sub>OFF</sub>	50% of V <sub>C</sub> to 10% / 90% RF	ns	—	52	—
Transients	In-band	mV	—	12	—
Control Current	-	μA	—	<1	5

4. External DC blocking capacitors are required on all RF ports (39 pF capacitors are recommended).

### Absolute Maximum Ratings<sup>5,6</sup>

Parameter	Absolute Maximum
Input Power, $V_{\text{HIGH}} = 3\text{ V}$ (0.5 - 3.0 GHz)	33 dBm
Operating Voltage	8 V
Operating Temperature	-40°C to +85°C
Storage Temperature	-65°C to +150°C

- Exceeding any one or combination of these limits may cause permanent damage to this device.
- MACOM does not recommend sustained operation near these survivability limits.

### Truth Table<sup>7,8,9</sup>

V1	V2	RFC-RF1	RFC-RF2
V <sub>HIGH</sub>	V <sub>LOW</sub>	On	Off
V <sub>LOW</sub>	V <sub>HIGH</sub>	Off	On

- $V_{\text{LOW}} = 0\text{ V} \pm 0.2\text{ V}$ ,  $V_{\text{HIGH}} = 1.8\text{ V to } +5\text{ V}$ , minimum  $V_{\text{High}} - V_{\text{Low}} = 1.8\text{ V}$ , maximum  $V_{\text{High}} - V_{\text{Low}} = 8.0\text{ V}$ .
- For use at low voltage, MACOM recommends connecting a 20K pull up resistor on pin 3 to a voltage equal to the most positive control voltage.
- Negative control voltage may be used. The V<sub>HIGH</sub> in the table would be the most positive (0 V) and the V<sub>LOW</sub> would be the most negative (-3 V for example).

## Typical Performance Curves

**Insertion Loss**

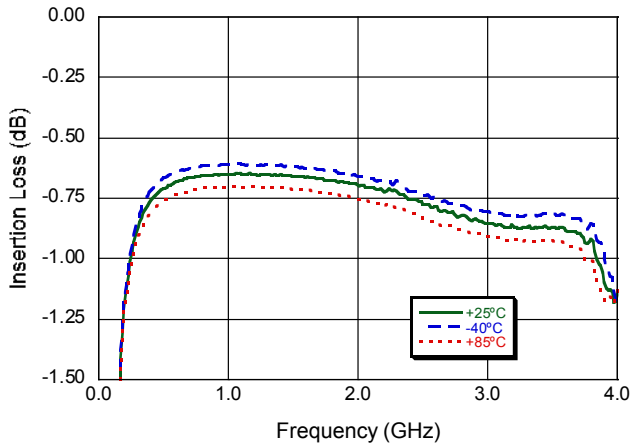

**Isolation**

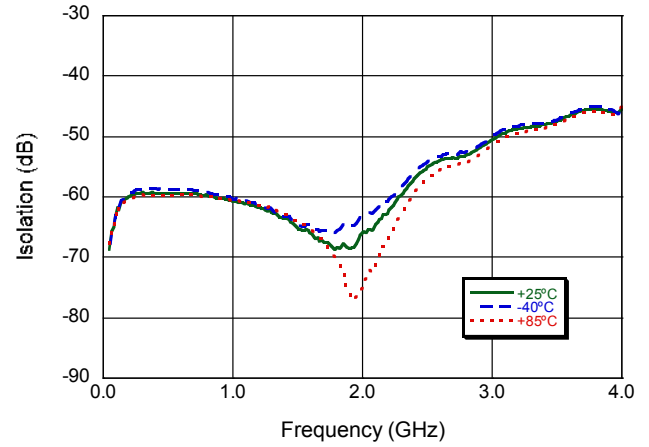

**Output Return Loss (on state)**

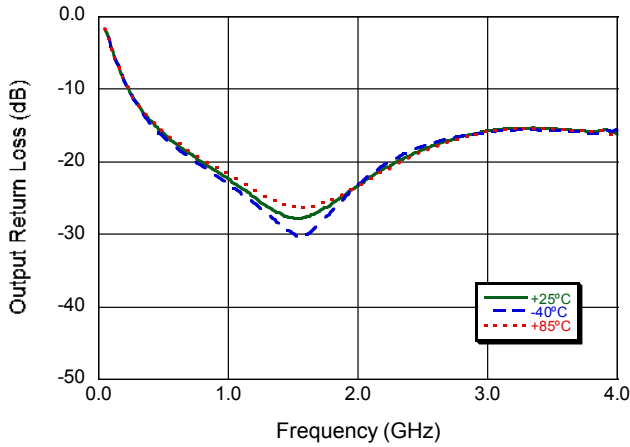

**Output Return Loss (off state)**

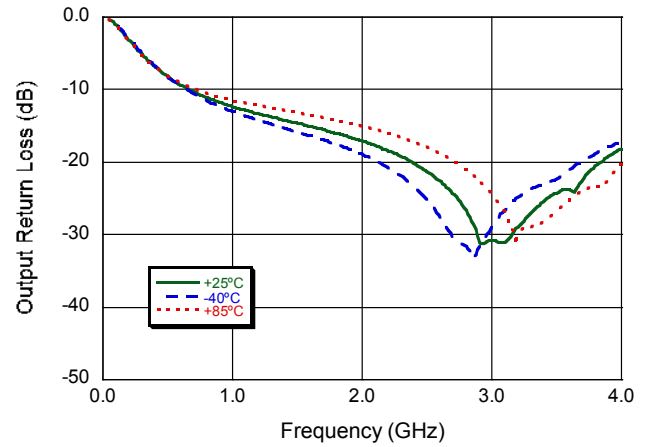

**Input Return Loss (on state)**

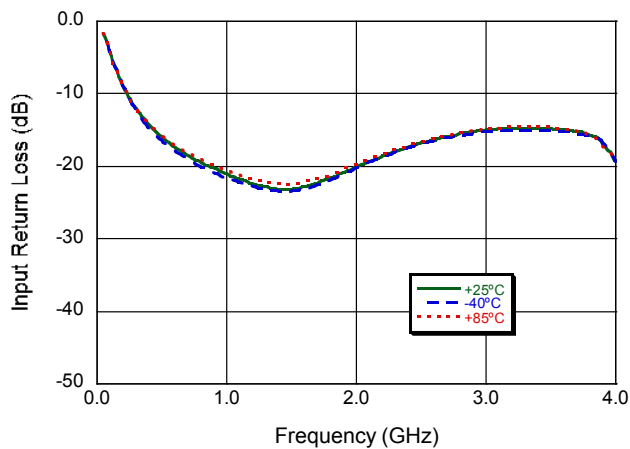

## Applications Section—Low Frequency Measurement

**Insertion Loss**

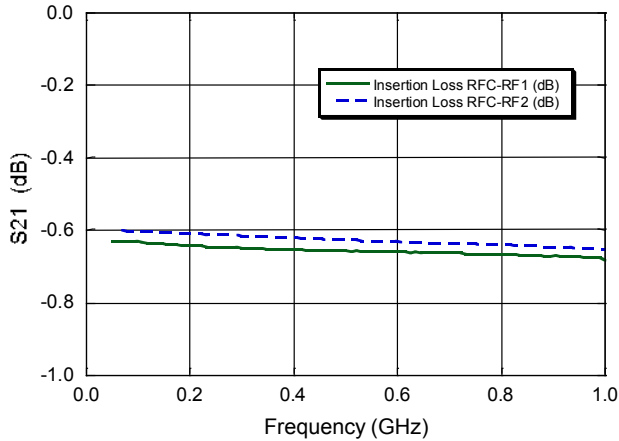

**Isolation**

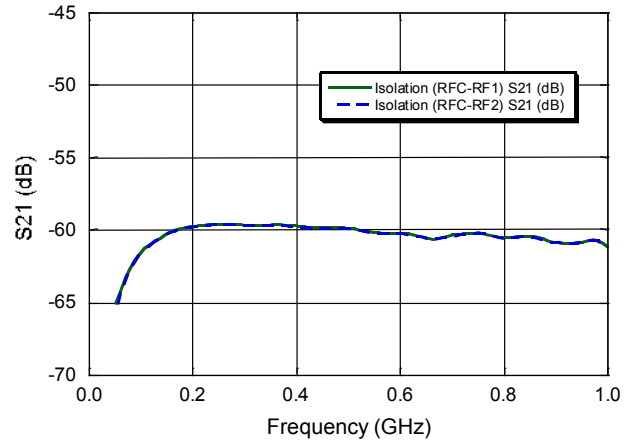

**Return Loss**

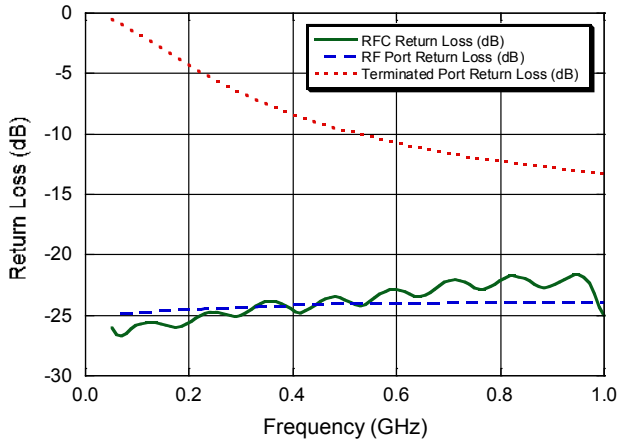

This data shows the MASW-008543 measured on an evaluation board with 0 Ω resistors. The board and connector loss have been removed.

0 Ω resistors can be used if negative control is available. To avoid changing the device bias points, the device should not be exposed to DC potentials on the RF ports.

With positive control MACOM recommends using DC-Blocking capacitors large enough that their  $X_c$  is insignificant at the frequency of use. At 50 MHz a capacitor value greater than 1000 pF is recommended.

### Lead-Free MSOP-8-EP†

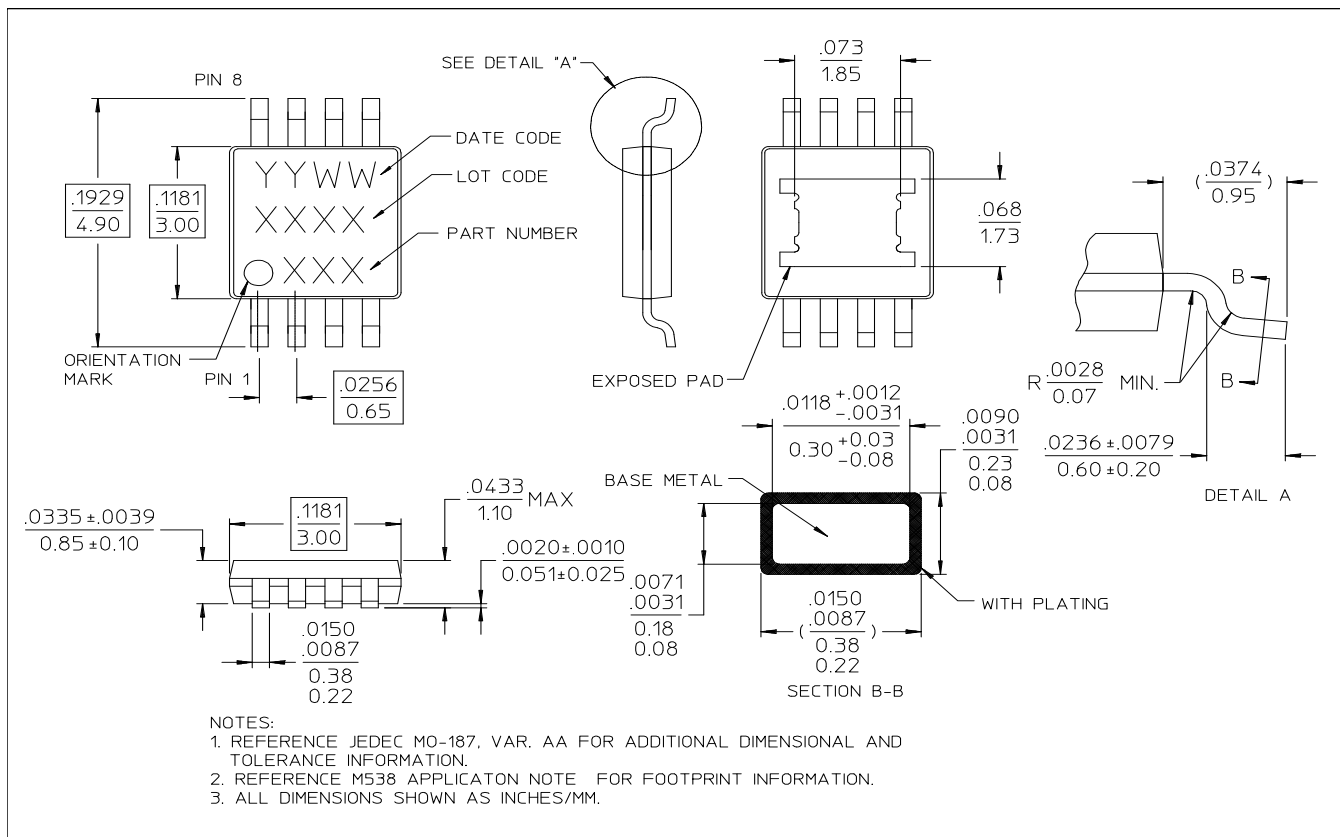

† Reference Application Note M538 for lead-free solder reflow recommendations.  
Meets JEDEC moisture sensitivity level 1 requirements.  
Plating is 100% matte tin over copper.

M/A-COM Technology Solutions Inc. All rights reserved.

Information in this document is provided in connection with M/A-COM Technology Solutions Inc ("MACOM") products. These materials are provided by MACOM as a service to its customers and may be used for informational purposes only. Except as provided in MACOM's Terms and Conditions of Sale for such products or in any separate agreement related to this document, MACOM assumes no liability whatsoever. MACOM assumes no responsibility for errors or omissions in these materials. MACOM may make changes to specifications and product descriptions at any time, without notice. MACOM makes no commitment to update the information and shall have no responsibility whatsoever for conflicts or incompatibilities arising from future changes to its specifications and product descriptions. No license, express or implied, by estoppel or otherwise, to any intellectual property rights is granted by this document.

THESE MATERIALS ARE PROVIDED "AS IS" WITHOUT WARRANTY OF ANY KIND, EITHER EXPRESS OR IMPLIED, RELATING TO SALE AND/OR USE OF MACOM PRODUCTS INCLUDING LIABILITY OR WARRANTIES RELATING TO FITNESS FOR A PARTICULAR PURPOSE, CONSEQUENTIAL OR INCIDENTAL DAMAGES, MERCHANTABILITY, OR INFRINGEMENT OF ANY PATENT, COPYRIGHT OR OTHER INTELLECTUAL PROPERTY RIGHT. MACOM FURTHER DOES NOT WARRANT THE ACCURACY OR COMPLETENESS OF THE INFORMATION, TEXT, GRAPHICS OR OTHER ITEMS CONTAINED WITHIN THESE MATERIALS. MACOM SHALL NOT BE LIABLE FOR ANY SPECIAL, INDIRECT, INCIDENTAL, OR CONSEQUENTIAL DAMAGES, INCLUDING WITHOUT LIMITATION, LOST REVENUES OR LOST PROFITS, WHICH MAY RESULT FROM THE USE OF THESE MATERIALS.

MACOM products are not intended for use in medical, lifesaving or life sustaining applications. MACOM customers using or selling MACOM products for use in such applications do so at their own risk and agree to fully indemnify MACOM for any damages resulting from such improper use or sale.