

Features

- Down Frequency Mixer
- Conversion Gain: 9 dB @ 12 GHz
- Low Noise: 7 dB @ 12 GHz
- Low Power Consumption: 3 V / 15 mA
- RF Frequency: 5 - 25 GHz
- LO Frequency: 4 - 23 GHz
- IF Frequency: DC - 8 GHz
- Single Positive Power Supply
- Lead-Free 1.5 x 1.2 mm TDFN 6-lead Package
- Halogen-Free “Green” Mold Compound
- RoHS* Compliant and 260°C Reflow

Description

The MAMX-011023 is a low noise active mixer assembled in a lead-free 1.5 x 1.2 mm TDFN plastic package. It is used for down frequency conversion, has an ultra wideband IF bandwidth of 8 GHz, and has the LO and RF driving the same pin.

This mixer can be used for either lower sideband (LSB) or upper sideband (USB) mixing.

Features of this mixer include unconditional stability, very low LO drive (<0 dBm) and low DC bias (< 50 mW). Typically the IF pin is set to 3 V and draws 15 mA when the LO drive is on. Typically the V_G pin is set to 0.6 V. This mixer achieves very low noise figure for an active mixer.

Ordering Information^{1,2}

| Part Number | Package |
|--------------------|-----------------|
| MAMX-011023-TR3000 | 3000 piece reel |
| MAMX-011023-SMB | Sample Board |

1. Reference Application Note M513 for reel size information.
2. All sample boards include 5 loose parts.

Functional Schematic

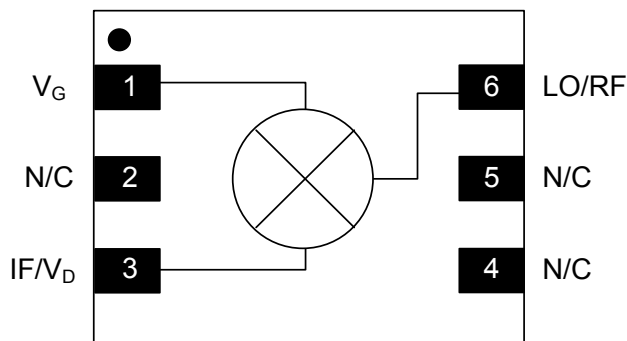

Pin Configuration³

| Pin No. | Pin Name | Description |
|---------|---------------------|------------------------|
| 1 | V_G | Gate Voltage |
| 2 | N/C | No Connection |
| 3 | IF/ V_D | IF Port/ Drain Voltage |
| 4 | N/C | No Connection |
| 5 | N/C | No Connection |
| 6 | RF & LO | RF & LO Port |
| 7 | Paddle ⁴ | Ground |

3. MACOM recommends connecting No Connection pins to ground.
4. The exposed pad centered on the package bottom must be connected to RF, DC and thermal ground.

* Restrictions on Hazardous Substances, European Union Directive 2011/65/EU.

**Electrical Specifications: $T_A = +25^\circ\text{C}$, $V_D = 3.0\text{ V}$, $V_G = 0.6\text{ V}$, $Z_0 = 50\ \Omega$,
IF Freq. = 2 GHz, LO Drive = -2 dBm @ 10 GHz, RF Freq. = 12 GHz**

| Parameter | Test Conditions | Units | Min. | Typ. | Max. |
|----------------|-----------------|-------|------|------|------|
| Gain | 6 GHz | dB | — | 4 | — |
| | 12 GHz | | 7 | 9 | |
| | 20 GHz | | — | 3 | |
| Noise Figure | 6 GHz | dB | — | 8 | — |
| | 12 GHz | | | 7 | |
| | 20 GHz | | | 10 | |
| RF Return Loss | 5 - 25 GHz | dB | — | 8 | — |
| IF Return Loss | DC - 8 GHz | dB | — | 2 | — |
| Input IP3 | Lower Sideband | dBm | — | +5 | — |
| | Upper Sideband | | | +8 | |
| LO Isolation | LO to IF | dB | — | 13 | — |
| | 2LO to IF | | | 85 | |
| | 3LO to IF | | | 100 | |
| Bias Current | V_D | mA | — | 15 | — |
| Bias Current | V_G | mA | — | 0.5 | — |

Absolute Maximum Ratings^{5,6}

| Parameter | Absolute Maximum |
|-----------------------------------|------------------|
| Total Input Power (RF+LO) | 15 dBm |
| Drain Voltage | 4 V / 35 mA |
| Gate Voltage | 1.5 V |
| Junction Temperature ⁷ | +150°C |
| Operating Temperature | -40°C to +85°C |
| Storage Temperature | -65°C to +150°C |

- Exceeding any one or combination of these limits may cause permanent damage to this device.
- MACOM does not recommend sustained operation near these survivability limits.
- Operating at nominal conditions with $T_J \leq +150^\circ\text{C}$ will ensure $\text{MTTF} > 1 \times 10^6$ hours.

Handling Procedures

Please observe the following precautions to avoid damage:

Static Sensitivity

Gallium Arsenide Integrated Circuits are sensitive to electrostatic discharge (ESD) and can be damaged by static electricity. Proper ESD control techniques should be used when handling these Class 1A (HBM) devices.

PCB Layout

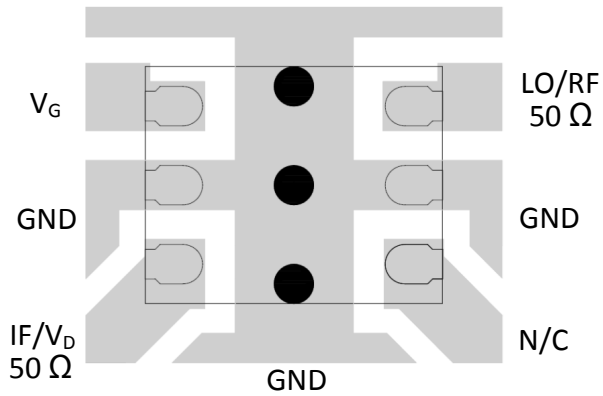

Application Information

The MAMX-011023 is designed to be an economical and easily used mixer. The ultra small size, on chip matching, and simple bias allows easy placement on any system board.

Parts List

| Part | Value | Case Style |
|---------|--------------|------------|
| C1 - C3 | 0.22 μ F | 0201 |
| FB1 | 600 Ω | 0201 |

Application Schematic

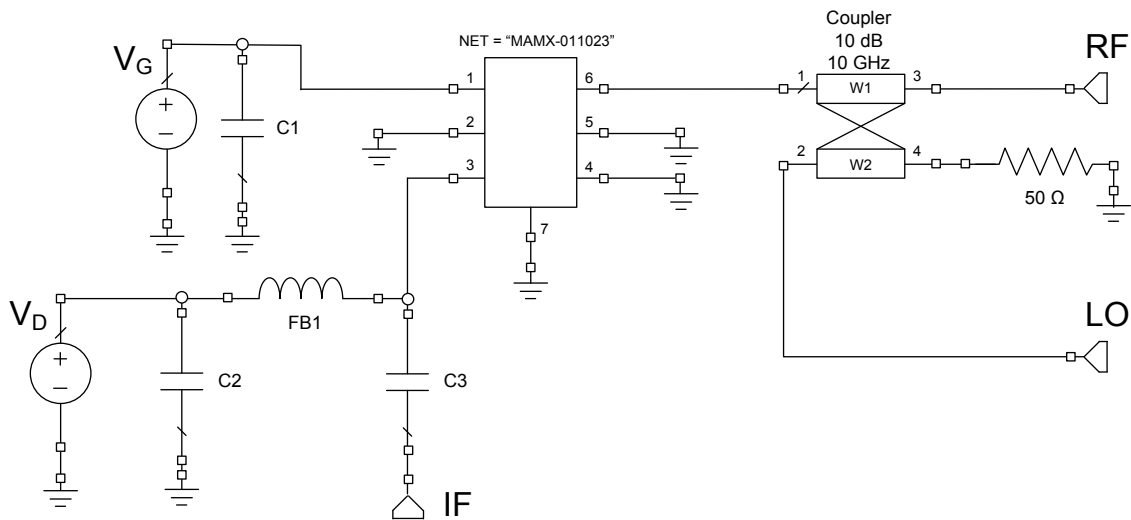

DC Biasing

The IF port DC bias voltage (V_D) and current requires a bias choke and DC blocking capacitor. The bias choke can be a ferrite bead (Murata BLM03HG601). Both V_G and the DC side of the ferrite bead should be bypassed with a capacitor (0.22 μ F 0201).

The V_G pin can be biased through a resistor connected to a V_D supply. A resistor value of $5812 \times (V_D - 1.1)$ will provide the correct current into V_G to bias the part.

Grounding

It is recommended that the total ground (common mode) inductance not exceed 0.03 nH. This is equivalent to three 8 mil (200 μ m) vias under the device on an 8 mil thick PC board combined with vias included in the ground plane around the package.

Operation

For best gain the IF port requires 2 to 3 volts of bias. The V_G port can be set to 0.6 V which will bias the part to approximately 2 mA and allow a minimal LO power to be used (approx. -2 dBm). When the LO power is on the device current will increase to approximately 15 mA.

RF / LO Combining

The MAMX-011023 has only one pin for RF and LO so the LO and RF must be combined. For PCB applications a printed directional coupler may be used to combine the RF and LO. Also, two MAMX-011023 may be used in a balanced operation by combining the RF and LO in a "rat race" or similar coupling structure. The balanced operation will improve LO rejection at the IF. Typically the RF input to the main coupler line and the LO is injected through the coupled line to minimize loss and maintain low noise figure.

Bias Schematic

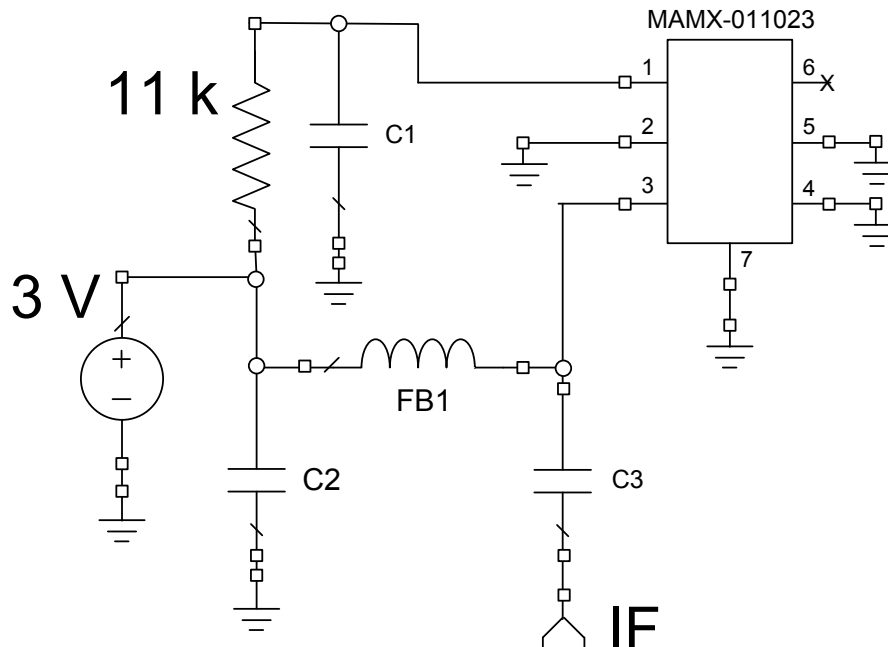

Low Noise Active Mixer 4 - 23 GHz

Rev. V2

Typical Performance Curves over Temperature

RF = -20 dBm, LO = -2 dBm, IF = 2 GHz, $V_D = 3$ V, $V_G = 0.6$ V, $Z_O = 50$ Ω , unless otherwise noted

Conversion Gain (LSB)

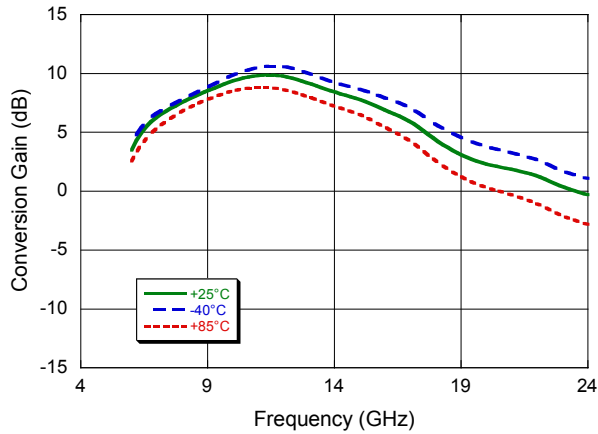

Conversion Gain (USB)

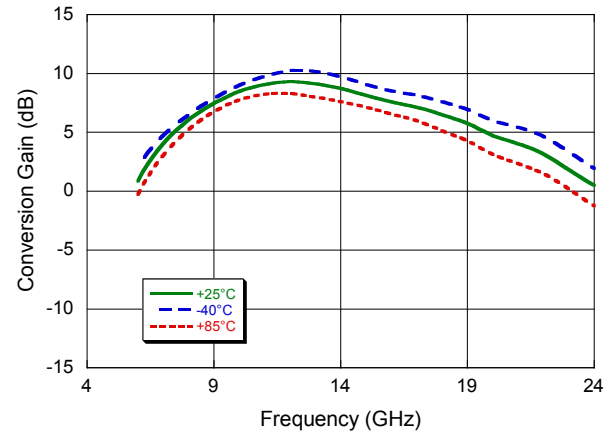

Noise Figure (LSB)

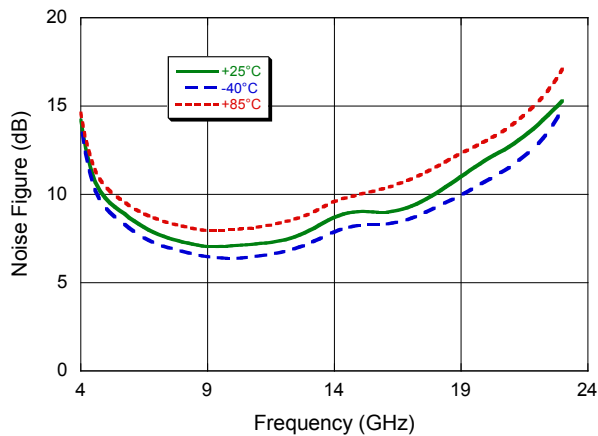

Noise Figure (USB)

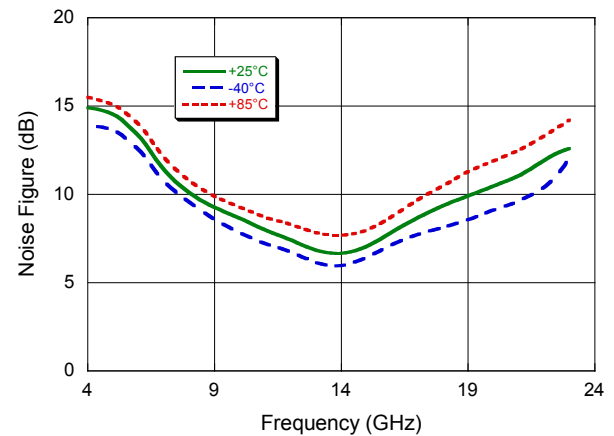

Input IP3 (LSB)

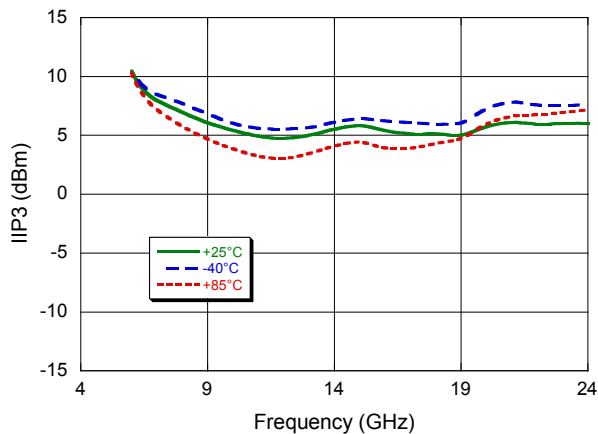

Input IP3 (USB)

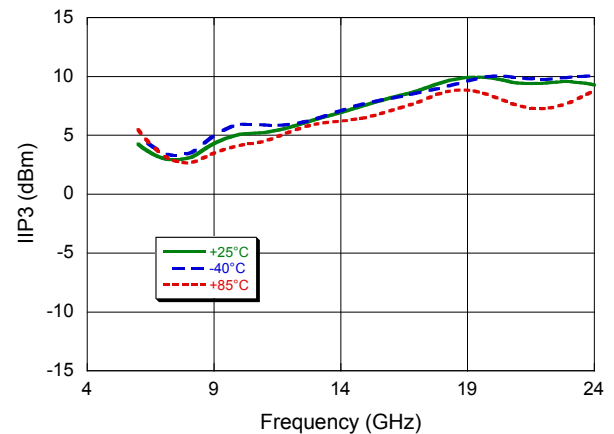

Low Noise Active Mixer 4 - 23 GHz

Rev. V2

Typical Performance Curves @ $T_A = +25^\circ\text{C}$

RF = -20 dBm, IF = 2 GHz, $V_D = 3\text{ V}$, $V_G = 0.6\text{ V}$, $Z_O = 50\ \Omega$, unless otherwise noted

Conversion Gain (LSB), over LO Power

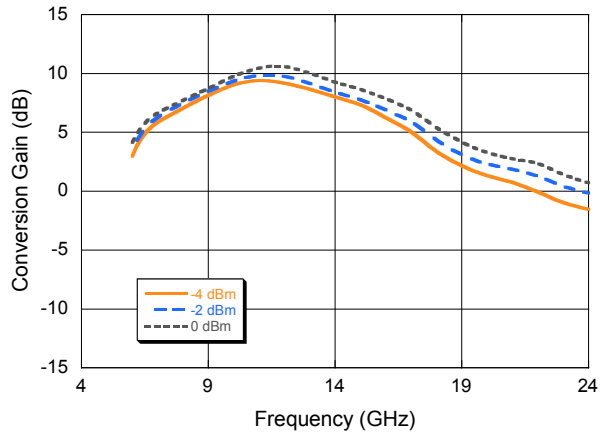

Conversion Gain (USB), over LO Power

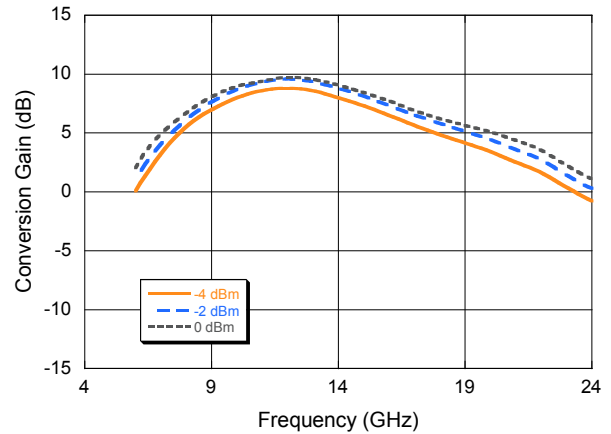

Noise Figure (LSB), over LO Power

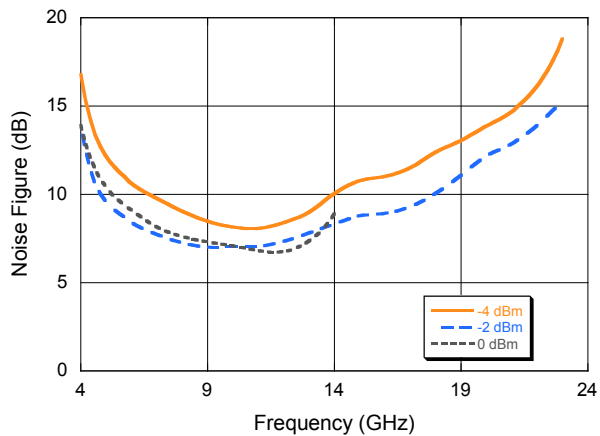

Noise Figure (USB), over LO Power

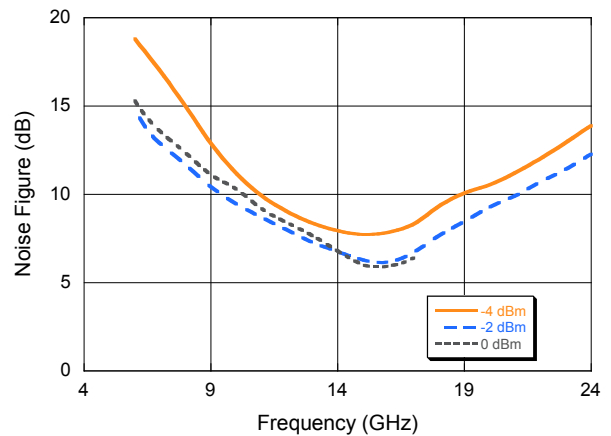

Input IP3 (LSB), over LO Power

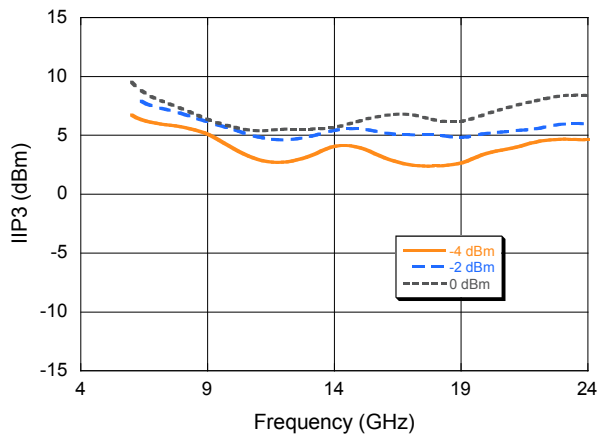

Input IP3 (USB), over LO Power

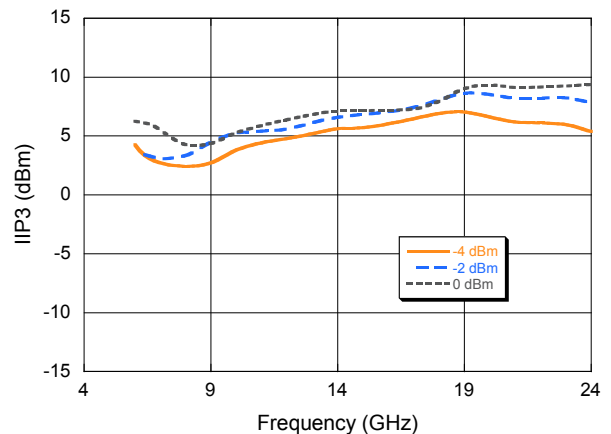

Low Noise Active Mixer 4 - 23 GHz

Rev. V2

Typical Performance Curves @ $T_A = +25^\circ\text{C}$

RF = -20 dBm, LO = -2 dBm, IF = 2 GHz, $V_D = 3\text{ V}$, $V_G = 0.6\text{ V}$, $Z_O = 50\ \Omega$, unless otherwise noted

Conversion Gain vs. IF Frequency

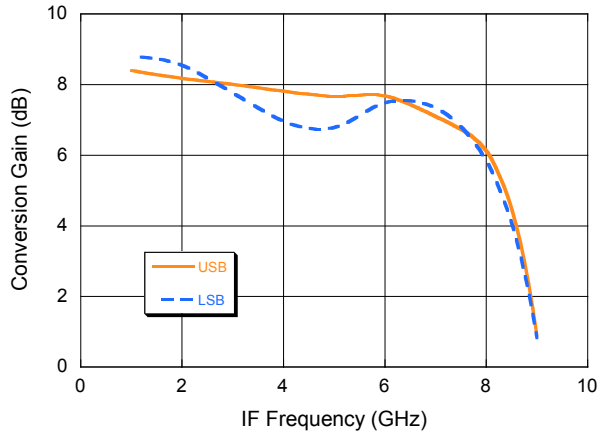

Input IP3 vs. IF Frequency

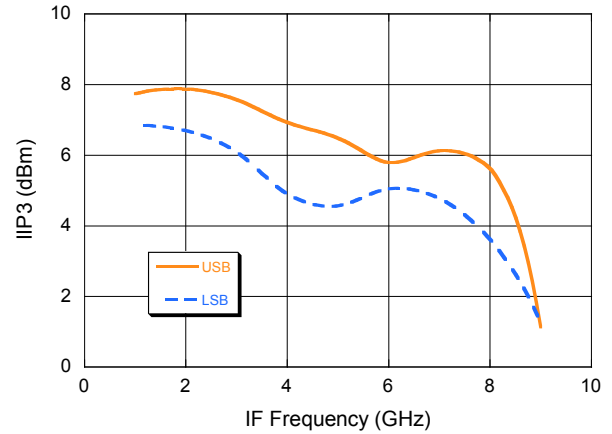

RF / LO Reflection

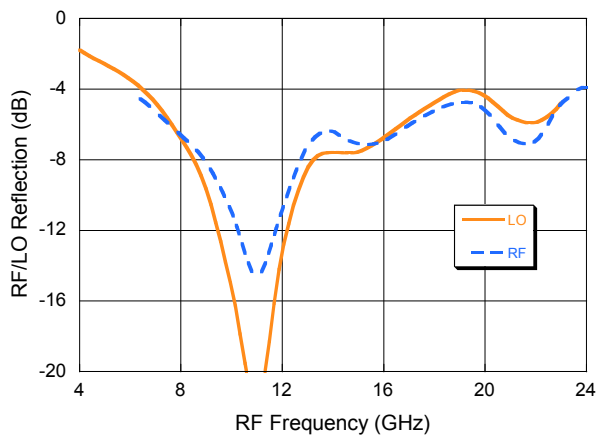

IF Reflection

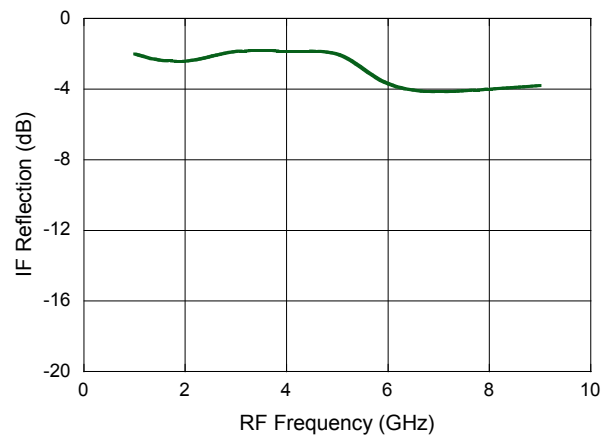

Stability @ -40°C

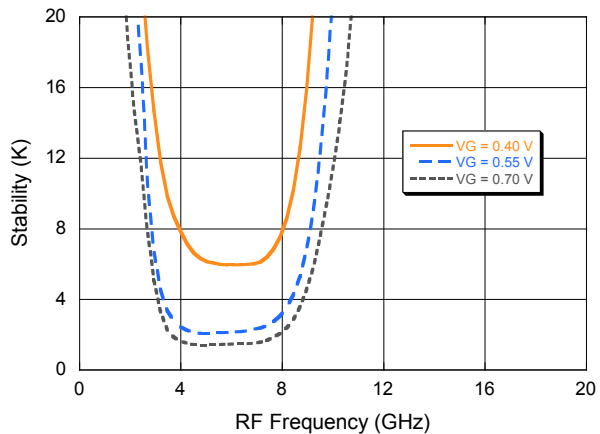

Conversion Gain (USB)

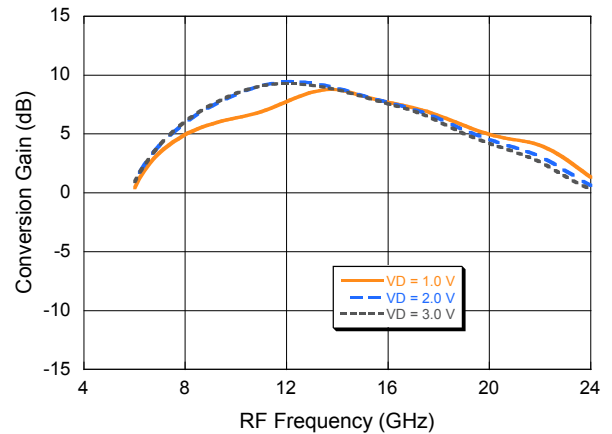

Low Noise Active Mixer 4 - 23 GHz

Rev. V2

Typical Performance Curves @ $T_A = +25^\circ\text{C}$

RF = 14 GHz, LO = 12 GHz, RF = -20 dBm, LO = -2 dBm, IF = 2 GHz, $Z_O = 50 \Omega$, unless otherwise noted

MxN Spurious Rejection at IF Port (dBc IF)

| mRF | nLO | | | |
|-----|-----|-----|-----|-----|
| | 1 | 2 | 3 | 4 |
| 1 | 0 | 44 | 71 | 73 |
| 2 | 73 | 34 | 40 | >85 |
| 3 | >85 | >85 | 53 | 53 |
| 4 | 79 | 81 | >85 | 40 |

Noise Figure vs. LO Power (LSB, USB)

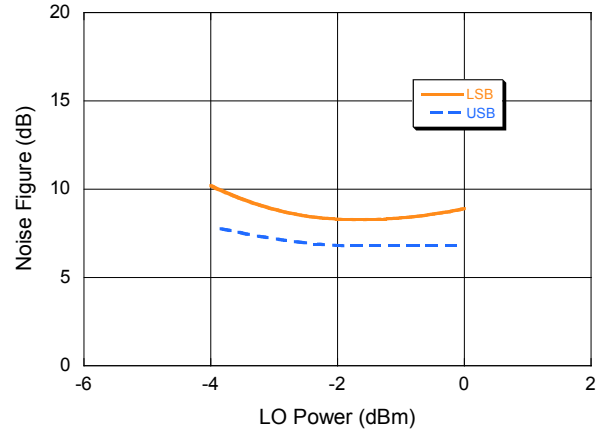

Conversion Gain vs. LO Power (LSB, USB)

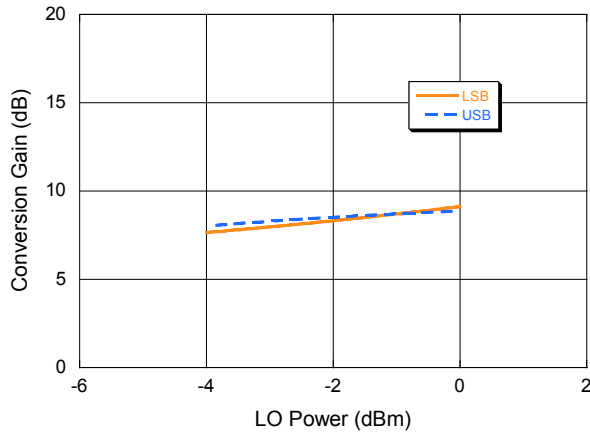

Input IP3 vs. LO Power (LSB, USB)

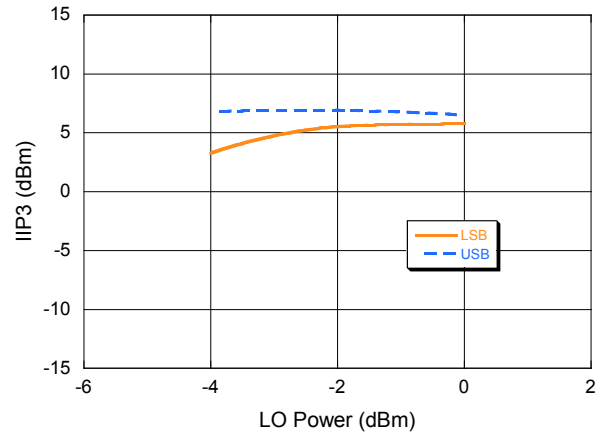

Conversion Gain vs. Bias (USB)

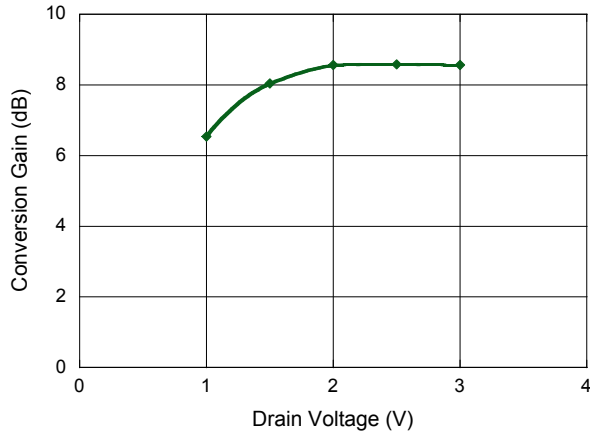

Noise Figure vs. Bias (USB)

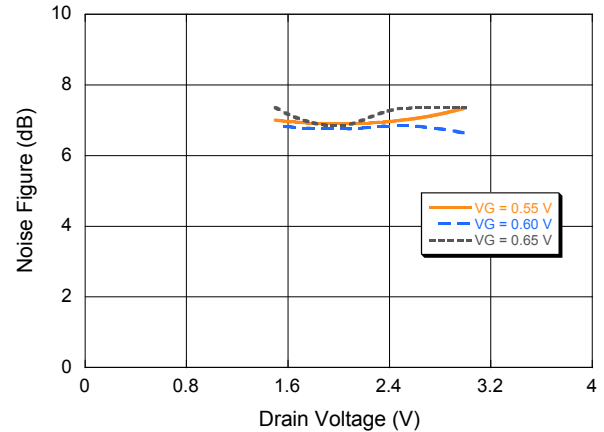

Lead-Free 1.5 x 1.2 mm 6-Lead TDFN[†]

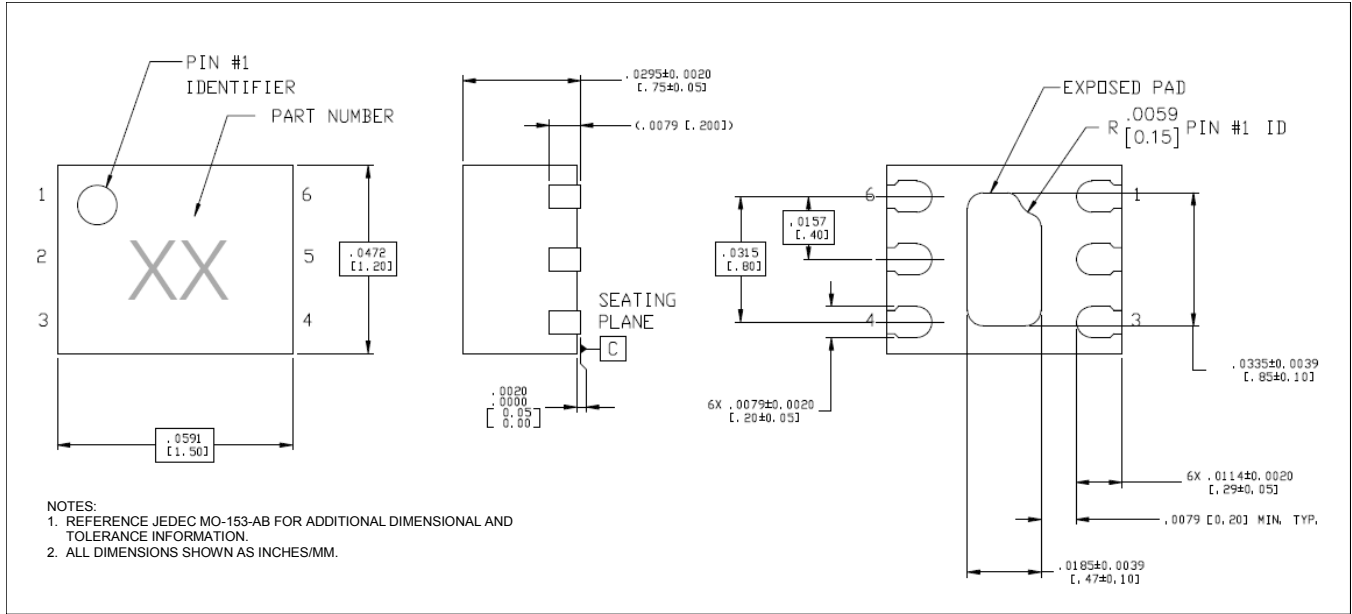

[†] Reference Application Note S2083 for lead-free solder reflow recommendations.
Meets JEDEC moisture sensitivity level 1 requirements.
Plating is 100% matte tin over copper.

Applications Section

System usage of this Mixer

The MAMX-011023 may be used in single ended, balanced, and image reject circuit configurations.

Single Ended Mixer

The single Ended mixer is the simplest use of the MAMX-011023. Some form of combiner is needed to put both the RF and LO signals on the input port and this combiner must allow low loss to the RF signal to preserve the low noise figure. A 10 dB quarter wavelength coupled line section can form a convenient and low cost combiner. The single ended mixer will have minimal rejection of RF, LO and image products at the IF.

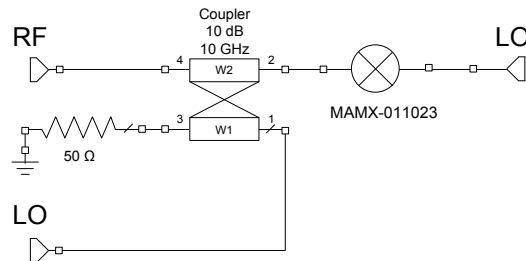

Balanced Mixer

The balanced mixer will improve mixer performance by cancelling the LO at the IF output and cancelling RF second order products. Linearity will be improved by using two mixers and RF loss will be limited to the rat race and transformer insertion losses.

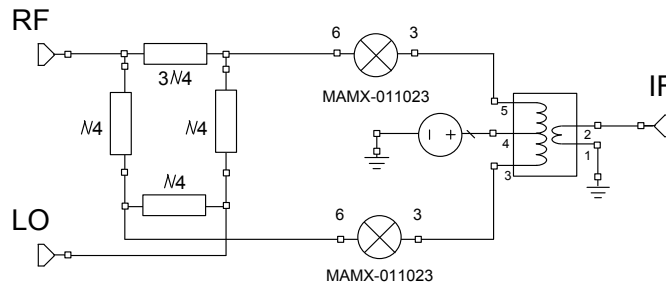

Image Reject Mixer

The Image Reject mixer can reject the desired upper or lower sideband RF signal and reject the corresponding image.

