

## Features

- 75 Ohm
- SMT unit
- RoHS\* Compliant

## Description

The MAFL-011026 is a low profile, surface mount filter with 3 transmission paths allowing full triplexer operation. The CATV reverse and forward bands are provided along with a further band meeting the MoCA specification. This filter is specifically designed for CATV and MoCA applications.

## Functional Schematic

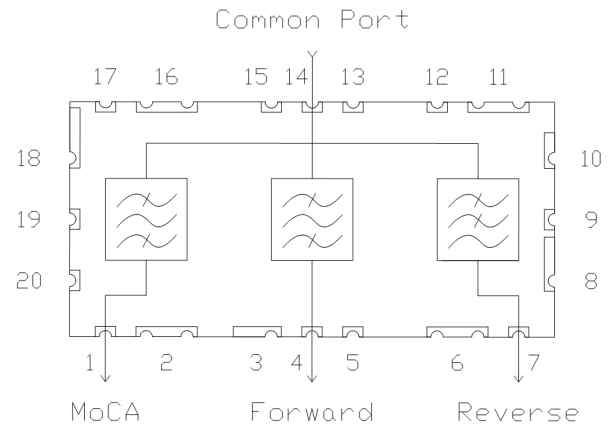

## Ordering Information

Part Number	Package
MAFL-011026	200 piece reel
MAFL-011026-Tray	480 piece tray

## Pin Configuration

Pin Number	Function
1	MoCA Port
4	Forward Port
7	Reverse Port
14	Common Port
2, 3, 5, 6, 8-13, 15-20	Ground

\* Restrictions on Hazardous Substances, European Union Directive 2011/65/EU.

**Electrical Specifications:  $T_A = +25^\circ\text{C}$ ,  $Z_0 = 75\Omega$**

Parameter	Test Conditions	Units	Min.	Typ.	Max.
Reverse Path Insertion Loss	5 - 85 MHz	dB	—	1.2	1.5
Reverse Path Rejection	105 - 126 MHz 126 - 1002 MHz 1125 - 1675 MHz 1675 - 3000 MHz	dB	62 64 60 30	70 70 64 50	—
Forward Path Insertion Loss	105 - 126 MHz 126 - 860 MHz 860 - 1002 MHz	dB	—	1.50 0.75 2.5	2.00 1.50 2.75
Forward Path Rejection	5 - 85 MHz 1125 - 1675 MHz 1675 - 3000 MHz	dB	50 43 20	52 45 30	—
MoCA Path Insertion Loss	1125 - 1150 MHz 1150 - 1650 MHz 1650 - 1675 MHz	dB	—	2.8 2.5 2.5	3.0 2.7 3.0
MoCA Path Rejection	5 - 85 MHz 85 - 1002 MHz 2300 - 3000 MHz	dB	49 49 25	70 55 35	—
Input Return Loss	5 - 85 MHz 105 - 860MHz 860 - 1002MHz 1125 - 1675 MHz	dB	16 16 12 12	18 18 16 16	—
Isolation - Forward to Reverse	5 - 38 MHz 38 - 85 MHz 105 - 1002 MHz	dB	55 43 60	58 45 65	—
Isolation - Forward to MoCA	5 - 85 MHz 105 - 126 MHz 126 - 1002 MHz 1125 - 1675 MHz	dB	49 49 49 43	70 70 53 45	—

## Recommended Maximum Ratings

Parameter	Absolute maximum
RF Power	250 mW
DC Current	30 mA
Operating temperature	-40°C to +85°C
Storage temperature	-40°C to +85°C

## PCB Layout

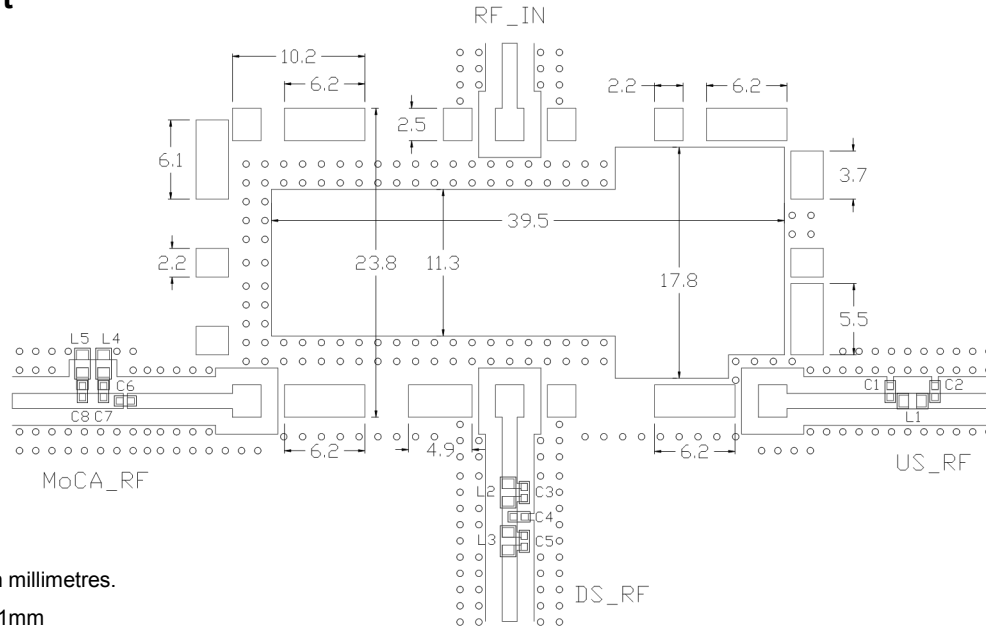

Dimensions are in millimetres.

Tolerance:  $.x \pm 0.1\text{mm}$

## Parts List

Part	Value	Case Style
C1	Do Not Insert	0402
C2	Do Not Insert	0402
C3	2.7pF +/- 0.25pF	0402
C4	1.3pF +/- 0.1pF	0402
C5	0.6pF +/- 0.1pF	0402
C6	2.0pF +/- 0.1pF	0402
C7	7.5pF +/- 0.25pF	0402
C8	3.9pF +/- 0.25pF	0402
L1	82nH +/- 2%	0603
L2	5.6nH +/- 2%	0603
L3	6.8nH +/- 2%	0603
L4	12nH +/- 2%	0603
L5	22nH +/- 2%	0603

## PCB Stack-Up

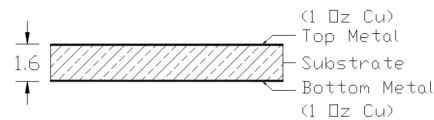

### Notes:

- Gap dimension = 1.3mm
- Track dimension = 1.15mm
- Substrate is 1.6mm thick FR4
- It is not recommended to run tracks under the filter
- A ground is required on the top layer of the application PCB
- RF shield should be kept a minimum of 10mm above the filter
- Any deviation from recommended footprint may compromise the filter performance
- For optimal filter performance the 4 transmission lines need to be at 75Ω impedance

## Application Schematic

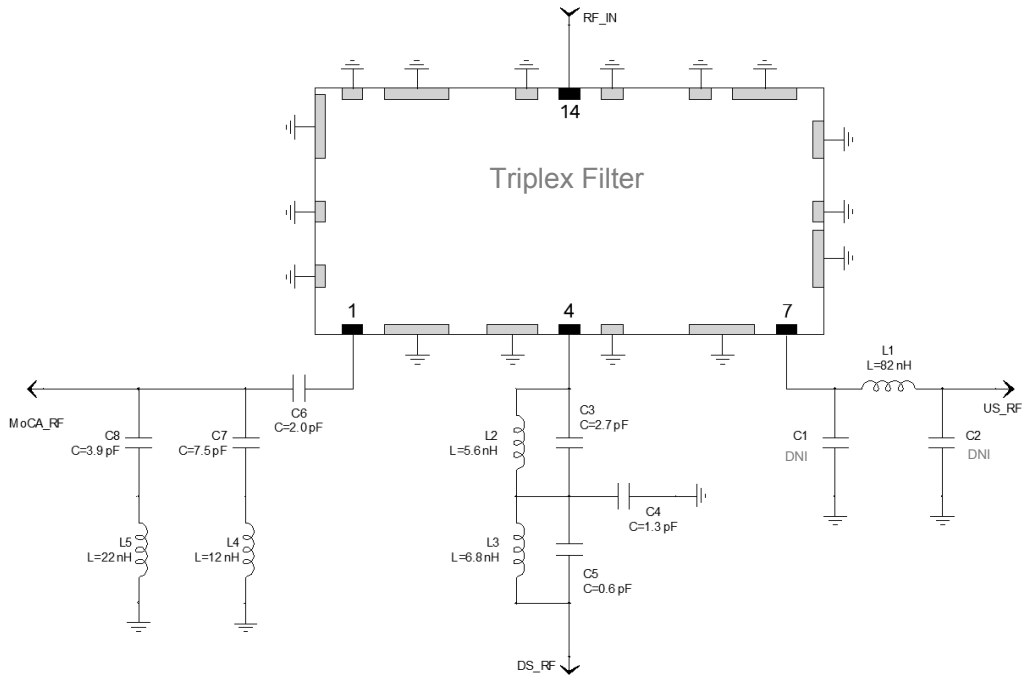

## Outline Dimensions

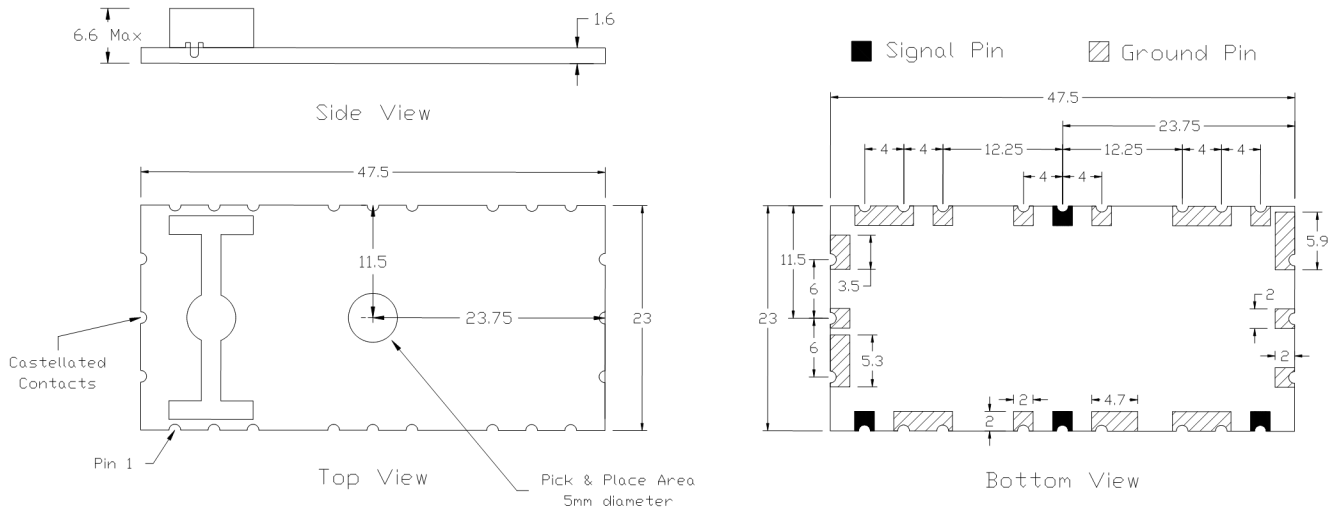

Dimensions are in millimetres.

Tolerance:  $.x \pm 0.1$  mm, except where specified.

## Typical Performance Curves

*Reverse Insertion Loss*

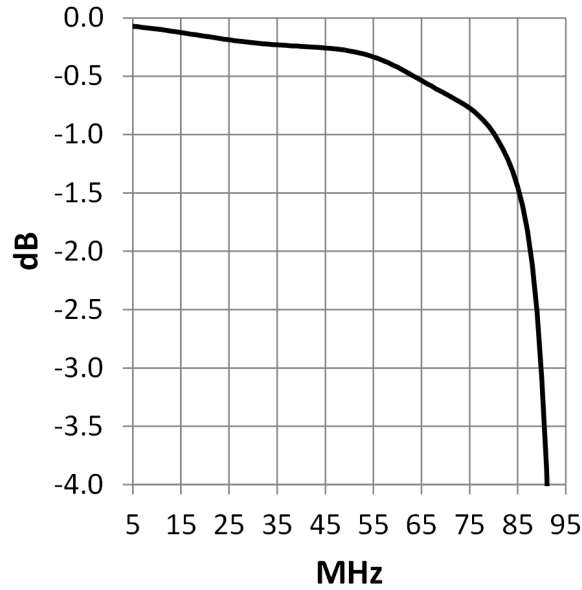

*Forward Insertion Loss*

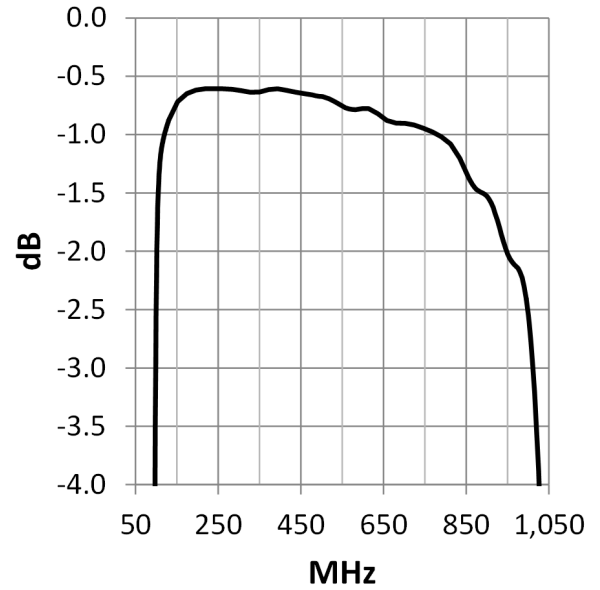

*MoCA Insertion Loss*

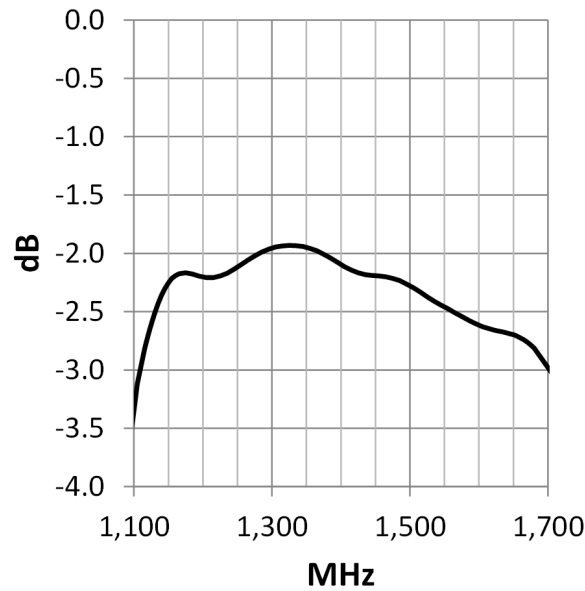

*Common Port Return Loss*

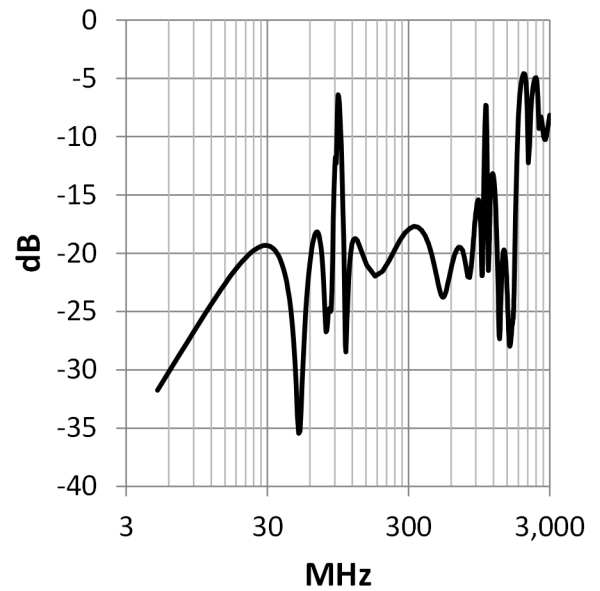

## Typical Performance Curves

**Reverse Path**

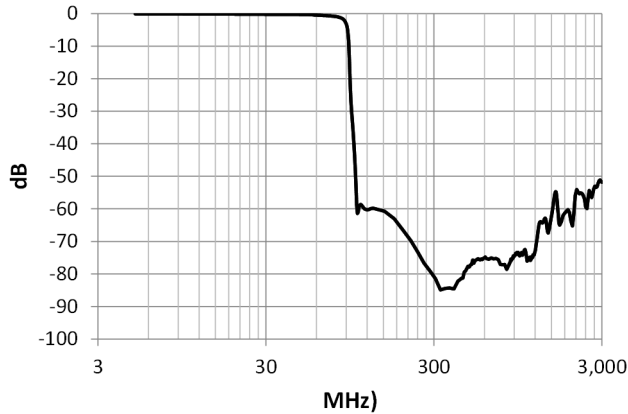

**Forward Path**

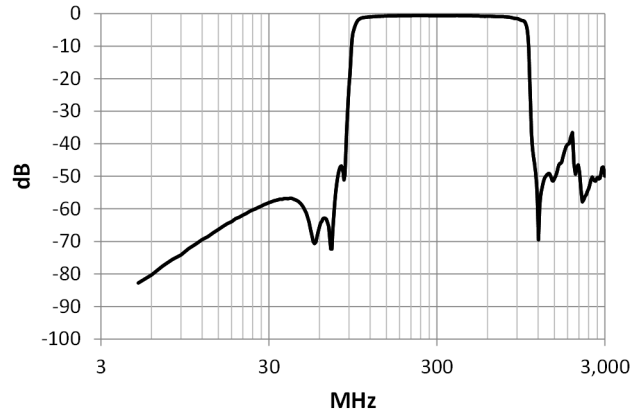

**MoCA Path**

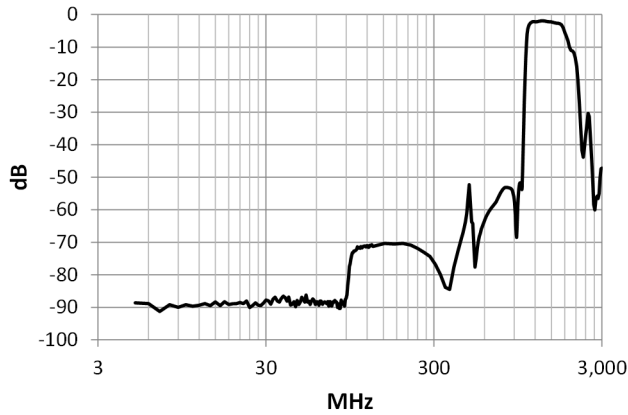

**Reverse to Forward Isolation**

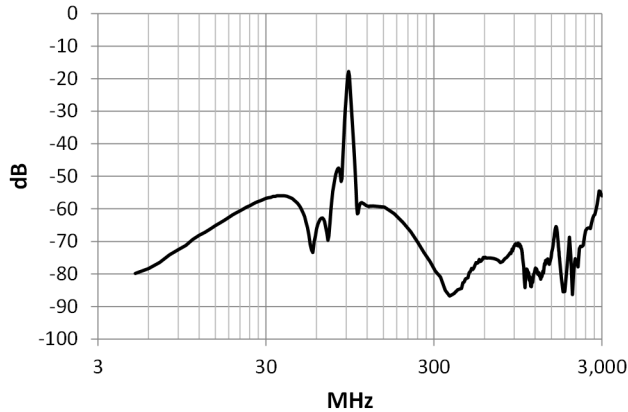

**Forward to MoCA Isolation**

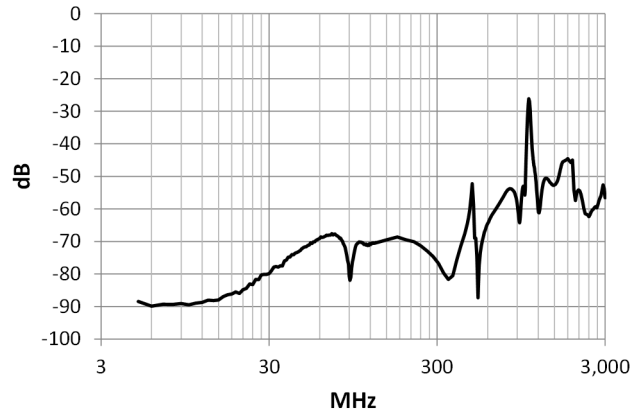

## Tape & Reel Information

Parameter	Units	Value
Qty per reel	-	200
Reel Size	mm	330
Tape Width	mm	72.0
Pitch	mm	28.0
Ao	mm	23.3
Bo	mm	47.8
Ko	mm	6.8
Orientation	-	F54
Reference Application Note ANI-019 for orientation		

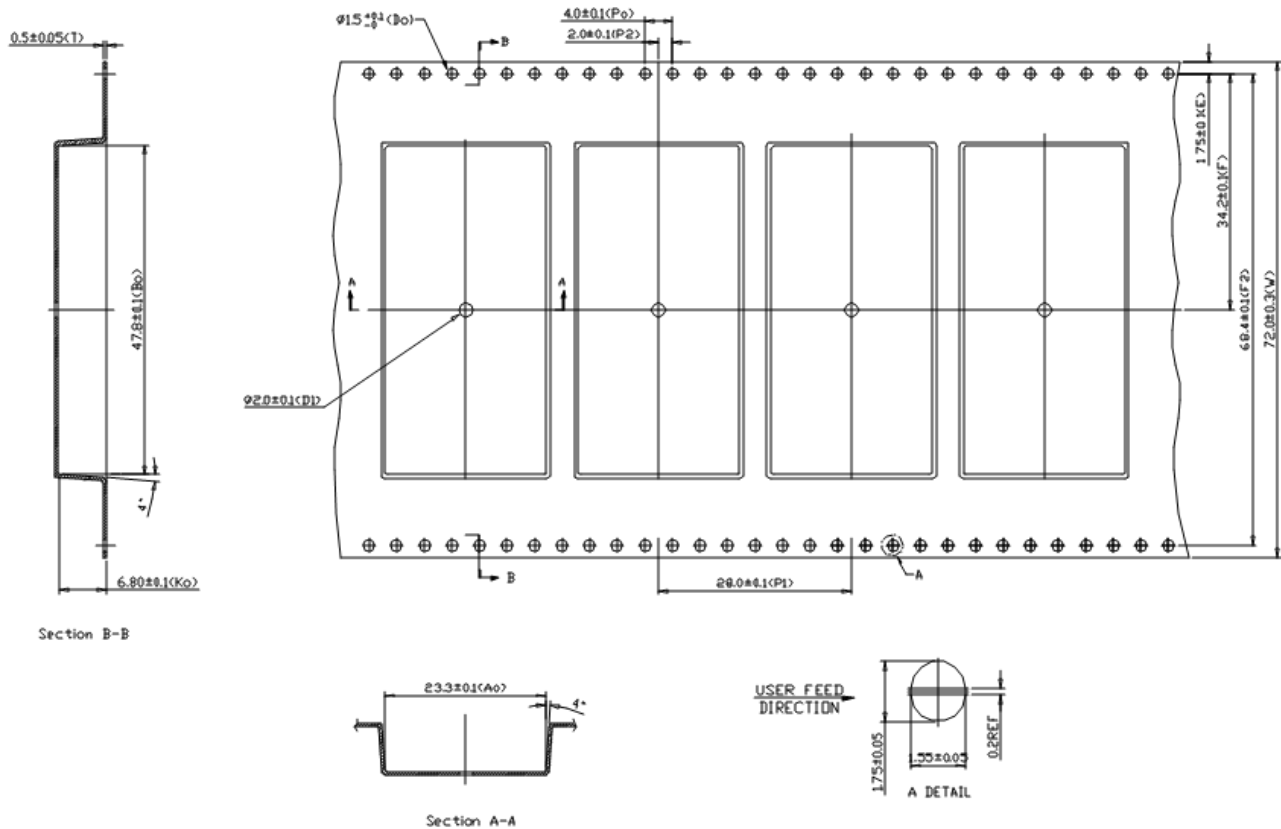

Dimensions are in millimetres.

Tolerance:  $.x \pm 0.1$  mm, except where specified.

7

## Tray Information

Parameter	Units	Value
Min Order Qty	-	480
Tray Length	mm	270
Tray Width	mm	200
Height	mm	20.8
Ao	mm	35
Bo	mm	50
Ko	mm	14.4
Orientation	-	See below
Consecutive trays will be stacked alternately at 180°		

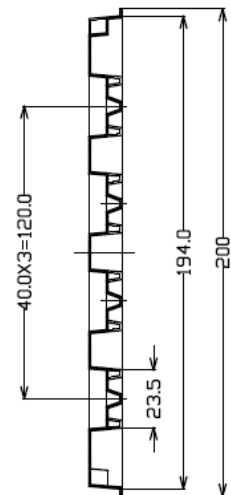
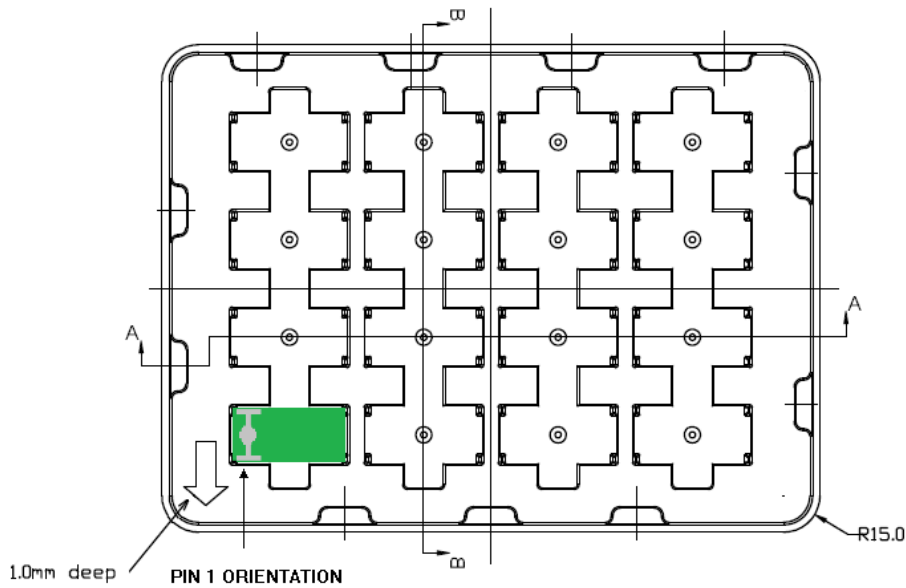

Section B-B

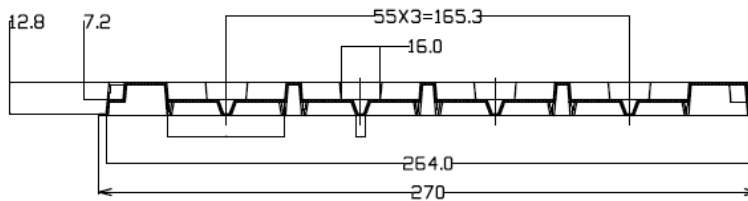

Section A-A

Dimensions are in millimetres.

Tolerance:  $.x \pm 0.1$  mm, except where specified.



M/A-COM Technology Solutions Inc. All rights reserved.

Information in this document is provided in connection with M/A-COM Technology Solutions Inc ("MACOM") products. These materials are provided by MACOM as a service to its customers and may be used for informational purposes only. Except as provided in MACOM's Terms and Conditions of Sale for such products or in any separate agreement related to this document, MACOM assumes no liability whatsoever. MACOM assumes no responsibility for errors or omissions in these materials. MACOM may make changes to specifications and product descriptions at any time, without notice. MACOM makes no commitment to update the information and shall have no responsibility whatsoever for conflicts or incompatibilities arising from future changes to its specifications and product descriptions. No license, express or implied, by estoppels or otherwise, to any intellectual property rights is granted by this document.

THESE MATERIALS ARE PROVIDED "AS IS" WITHOUT WARRANTY OF ANY KIND, EITHER EXPRESS OR IMPLIED, RELATING TO SALE AND/OR USE OF MACOM PRODUCTS INCLUDING LIABILITY OR WARRANTIES RELATING TO FITNESS FOR A PARTICULAR PURPOSE, CONSEQUENTIAL OR INCIDENTAL DAMAGES, MERCHANTABILITY, OR INFRINGEMENT OF ANY PATENT, COPYRIGHT OR OTHER INTELLECTUAL PROPERTY RIGHT. MACOM FURTHER DOES NOT WARRANT THE ACCURACY OR COMPLETENESS OF THE INFORMATION, TEXT, GRAPHICS OR OTHER ITEMS CONTAINED WITHIN THESE MATERIALS. MACOM SHALL NOT BE LIABLE FOR ANY SPECIAL, INDIRECT, INCIDENTAL, OR CONSEQUENTIAL DAMAGES, INCLUDING WITHOUT LIMITATION, LOST REVENUES OR LOST PROFITS, WHICH MAY RESULT FROM THE USE OF THESE MATERIALS.

MACOM products are not intended for use in medical, lifesaving or life sustaining applications. MACOM customers using or selling MACOM products for use in such applications do so at their own risk and agree to fully indemnify MACOM for any damages resulting from such improper use or sale.