

Frequency Doubler 16 - 24 GHz Output

Rev. V2

Features

- 16 - 24 GHz Output Frequency Range
- 20 dBm Output Power
- High $1x F_{IN}$ and $3x F_{IN}$ Suppression
- High Dynamic Range
- Lead-Free 4 mm, 16-Lead QFN Package
- RoHS* Compliant and 260°C Reflow Compatible

Description

The MAFC-004403 is an active frequency doubler with an output frequency range of 16 - 24 GHz. The input power level ranges from 0 to 6 dBm, delivering a typical output power of 20 dBm. The device has excellent input and output return losses, and high $1x F_{in}$ and $3x F_{in}$ isolations.

The MAFC-004403 is ideally suited for use in LO chains in Point-to-Point radios for cellular backhaul applications. The 4mm QFN package is RoHS compliant and compatible with reflow temperatures to 260°C.

Functional Block Diagram

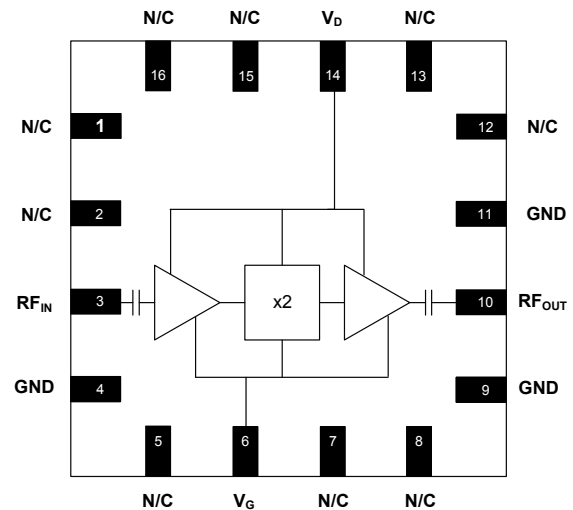

Pin Configuration^{1,2}

Pin No.	Function	Description
1	N/C	No Connection
2	N/C	No Connection
3	RF _{IN}	RF Input
4	GND	Ground
5	N/C	No Connection
6	V _G	Gate Voltage
7	N/C	No Connection
8	N/C	No Connection
9	GND	Ground
10	RF _{OUT}	RF Output
11	GND	Ground
12	N/C	No Connection
13	N/C	No Connection
14	V _D	Drain Voltage
15	N/C	No Connection
16	N/C	No Connection

Ordering Information

Part Number	Package
MAFC-004403-TR0500	500 piece reel
MAFC-004403-TR1000	1000 piece reel
MAFC-004403-TR3000	3000 piece reel
MAFC-004403-001SMB	Sample Test Board

*Restrictions on Hazardous Substances,
European Union Directive 2011/65/EU.

1. It is recommended that all No Connection pins (N/C) are connected to ground.
2. The exposed pad centered on the package bottom must be connected to RF and DC ground.

Frequency Doubler 16 - 24 GHz Output

Rev. V2

Electrical Specifications: $V_D = +5\text{ V}$, $V_G = -0.7\text{ V}$, $P_{IN} = 0\text{ dBm}$, $T_A = +25^\circ\text{C}$

Parameter	Units	Min.	Typ.	Max.
Frequency (Input)	GHz	8	—	12
Frequency (Output)	GHz	16	—	24
Output Power (P_{OUT})	dBm	+18	+20	—
$1x F_{IN}$ Leakage	dBc	—	30	—
$3x F_{IN}$ Leakage	dBc	—	20	—
$4x F_{IN}$ Leakage	dBc	—	20	—
Input Return Loss	dB	—	12	—
Output Return Loss	dB	—	12	—
Supply Current (I_D)	mA	95	140	170

Absolute Maximum Ratings ^{3,4,5}

Parameter	Absolute Maximum
Input Power	+8 dBm
Drain Voltage	+7 V
Gate Voltage	-1.5 V to 0 V
Storage Temperature	-55°C to +150°C
Case Temperature	-40°C to +85°C
Junction Temperature ⁶	+160 °C

- Exceeding any one or combination of these limits may cause permanent damage to this device.
- MACOM does not recommend sustained operation near these survivability limits.
- Operating at nominal conditions with $T_J \leq 160^\circ\text{C}$ will ensure $MTTF > 1 \times 10^6$ hours.
- Junction Temperature (T_J) = $T_C + \Theta_{jc} * ((V * I) - (P_{OUT} - P_{IN}))$
Typical thermal resistance (Θ_{jc}) = 93°C/W .
 - For $T_C = 25^\circ\text{C}$,
 $T_J = 81^\circ\text{C}$ @ 5 V, 130 mA, $P_{IN} = +5\text{ dBm}$, $P_{OUT} = 17\text{ dBm}$
 - For $T_C = 85^\circ\text{C}$,
 $T_J = 141^\circ\text{C}$ @ 5 V, 130 mA, $P_{IN} = +5\text{ dBm}$, $P_{OUT} = 17\text{ dBm}$

Handling Procedures

The following precautions should be observed to avoid damage:

Static Sensitivity

Gallium Arsenide Integrated Circuits are sensitive to electrostatic discharge (ESD) and can be damaged by static electricity. Proper ESD control techniques should be used when handling these Class 1A devices.

Frequency Doubler 16 - 24 GHz Output

Rev. V2

Typical Performance Curves: $V_D = +5\text{ V}$, $V_G = -0.7\text{ V}$, $Z_0 = 50\ \Omega$

Output Power @ $2x F_{IN}$ vs. Temp., $P_{IN} = 0, 3, 6\text{ dBm}$

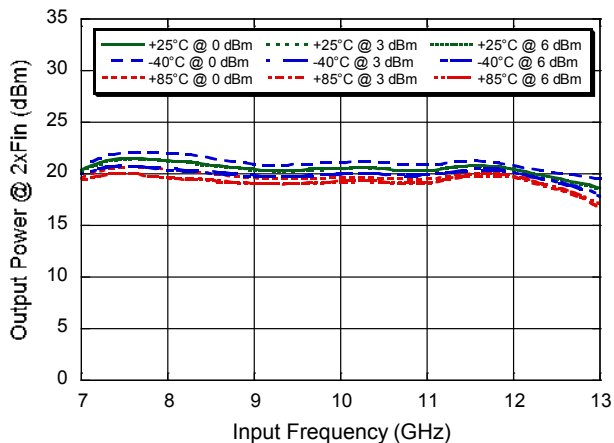

Output Power @ $1x F_{IN}$ vs. Temp., $P_{IN} = 0, 3, 6\text{ dBm}$

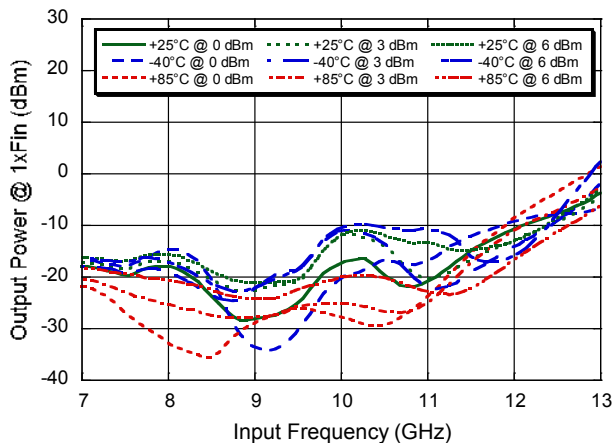

Output Power @ $3x F_{IN}$ vs. Temp., $P_{IN} = 0, 3, 6\text{ dBm}$

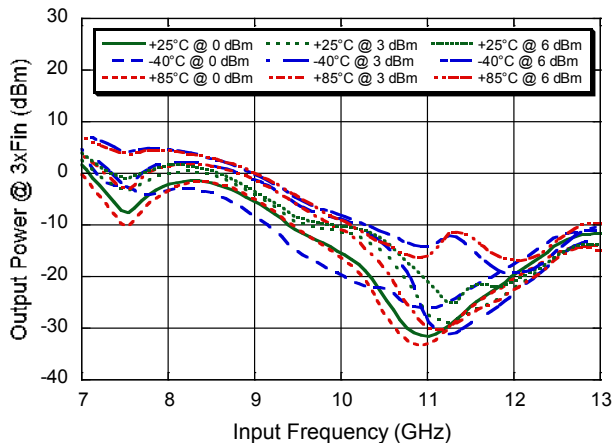

Output Power @ $1x F_{IN}$, $2x F_{IN}$ & $3x F_{IN}$, $P_{IN} = 0\text{ dBm}$

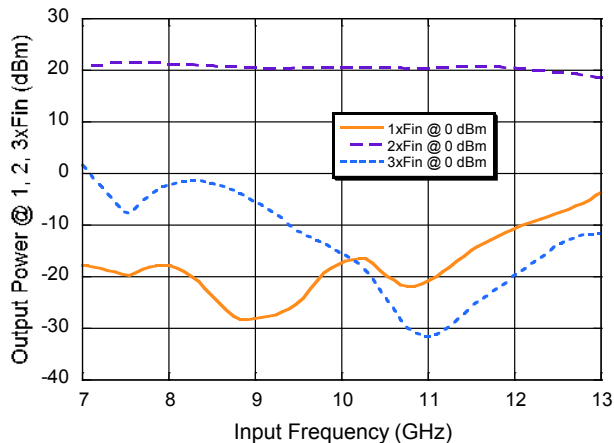

Supply Current

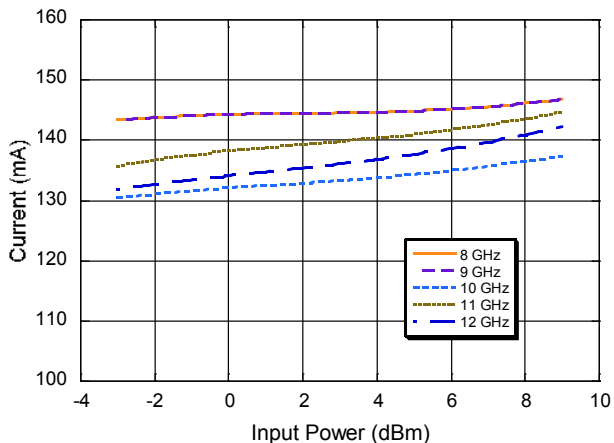

Return Loss

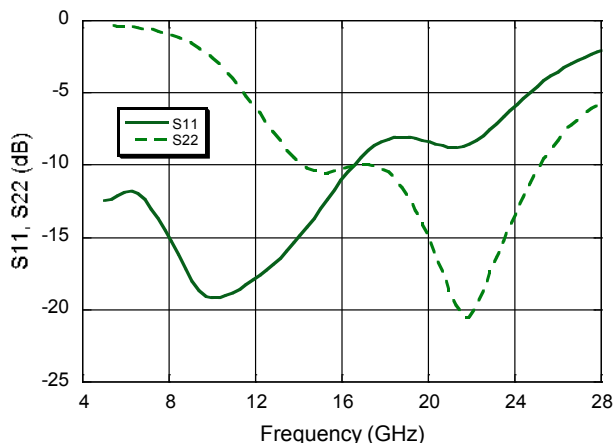

M/A-COM Technology Solutions Inc. All rights reserved.

Information in this document is provided in connection with M/A-COM Technology Solutions Inc ("MACOM") products. These materials are provided by MACOM as a service to its customers and may be used for informational purposes only. Except as provided in MACOM's Terms and Conditions of Sale for such products or in any separate agreement related to this document, MACOM assumes no liability whatsoever. MACOM assumes no responsibility for errors or omissions in these materials. MACOM may make changes to specifications and product descriptions at any time, without notice. MACOM makes no commitment to update the information and shall have no responsibility whatsoever for conflicts or incompatibilities arising from future changes to its specifications and product descriptions. No license, express or implied, by estoppel or otherwise, to any intellectual property rights is granted by this document.

THESE MATERIALS ARE PROVIDED "AS IS" WITHOUT WARRANTY OF ANY KIND, EITHER EXPRESS OR IMPLIED, RELATING TO SALE AND/OR USE OF MACOM PRODUCTS INCLUDING LIABILITY OR WARRANTIES RELATING TO FITNESS FOR A PARTICULAR PURPOSE, CONSEQUENTIAL OR INCIDENTAL DAMAGES, MERCHANTABILITY, OR INFRINGEMENT OF ANY PATENT, COPYRIGHT OR OTHER INTELLECTUAL PROPERTY RIGHT. MACOM FURTHER DOES NOT WARRANT THE ACCURACY OR COMPLETENESS OF THE INFORMATION, TEXT, GRAPHICS OR OTHER ITEMS CONTAINED WITHIN THESE MATERIALS. MACOM SHALL NOT BE LIABLE FOR ANY SPECIAL, INDIRECT, INCIDENTAL, OR CONSEQUENTIAL DAMAGES, INCLUDING WITHOUT LIMITATION, LOST REVENUES OR LOST PROFITS, WHICH MAY RESULT FROM THE USE OF THESE MATERIALS.

MACOM products are not intended for use in medical, lifesaving or life sustaining applications. MACOM customers using or selling MACOM products for use in such applications do so at their own risk and agree to fully indemnify MACOM for any damages resulting from such improper use or sale.