

## Low Noise Amplifier 0.1 - 3.5 GHz

Rev. V3

### Features

- Single Voltage Supply 3V ~ 5V
- Integrated Active Bias Circuit
- Adjustable Current with an External Resistor
- Low Noise Figure
- High Linearity OIP3: 34.5 dBm @ 2 GHz
- Broadband Match
- Integrated ESD Protection
- RoHS\* Compliant and 260°C Reflow Compatible

### Description

The MAAL-010570 is a high dynamic range single stage MMIC LNA with excellent linearity and low noise figure designed for operation from 0.1 to 3.5 GHz. The LNA is packaged in an RoHS compliant SOT-363 package and requires no external matching components.

This MMIC has an integrated active bias circuit allowing direct connection to +3 V supply and minimizing variation over temperature and process. The bias current can be set with an external resistor to allow the user to customize the current value to fit the application.

The MAAL-010570 offers less than 1 dB noise figure and 34.5 dBm OIP3 at 2 GHz. The broadband match and single supply operation makes this LNA easy to use and simplifies its implementation while maintaining excellent performance. The low thermal resistance and integrated ESD protection significantly enhances the quality, reliability and ruggedness of this product.

### Ordering Information<sup>1,2</sup>

Part Number	Package
MAAL-010570-000000	bulk quantity
MAAL-010570-TR3000	3000 piece reel
MAAL-010570-001SMB	evaluation board (100 MHz ~ 3.5 GHz)

1. Reference Application Note M513 for reel size information.
2. All sample boards include 5 loose parts.

\* Restrictions on Hazardous Substances, European Union Directive 2011/65/EU.

### Functional Block Diagram

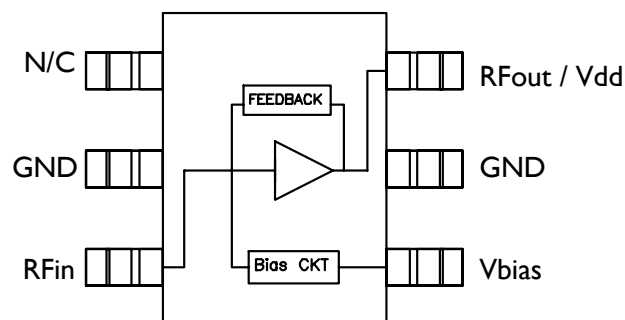

### Pin Configuration<sup>3</sup>

Pin No.	Pin Name	Description
1	N/C	No Connection
2	GND	Ground
3	RF <sub>IN</sub>	RF Input
4	V <sub>BIAS</sub>	Bias Voltage
5	GND	Ground
6	RF <sub>OUT</sub>	RF Output

3. It is recommended that all N/C (no connection) pins be grounded.

## Low Noise Amplifier 0.1 - 3.5 GHz

Rev. V3

### Typical Performance<sup>4,5</sup>: $I_{DD} = 60 \text{ mA}$ , $I_{BIAS} = 8 \text{ mA}$ , $+25^\circ\text{C}$

Parameter	Units	Typical Ratings									
<b><math>V_{DD} = 3 \text{ V}</math></b>											
Frequency	GHz	0.2	0.5	0.8	1.0	1.5	2.0	2.5	3.0	3.5	
Gain	dB	22.0	21.5	19.5	18.5	16.0	14.0	12.5	11.0	10.0	
Output IP3	dBm	33.2	34.9	36.7	33.7	34.0	34.5	35.0	36.7	37.2	
Output P1dB	dBm	17.0	18.0	18.6	18.3	18.8	19.1	19.0	19.1	18.4	
Input Return Loss	dB	11.0	13.0	13.0	12.7	12.0	11.4	10.5	10.0	9.1	
Output Return Loss	dB	19.0	26.0	23.0	22.0	20.5	20.5	20.0	19.5	20.0	
Noise Figure	dB	0.70	0.80	0.75	0.74	0.75	0.84	0.93	1.10	1.20	
<b><math>V_{DD} = 5 \text{ V}</math></b>											
Frequency	GHz	0.2	0.5	0.8	1.0	1.5	2.0	2.5	3.0	3.5	
Gain	dB	22.0	21.5	19.5	18.5	16.0	14.0	12.5	11.0	10.0	
Output IP3	dBm	31.8	34.0	35.0	36.5	36.2	36.5	37.1	37.6	36.8	
Output P1dB	dBm	22.0	21.0	22.0	21.9	22.2	22.2	22.4	22.4	22.1	
Input Return Loss	dB	11.0	13.0	13.0	12.7	12.0	11.5	10.5	10.0	9.0	
Output Return Loss	dB	22.0	26.0	20.0	19.0	17.5	17.0	17.0	16.5	17.0	
Noise Figure	dB	0.80	0.84	0.80	0.78	0.80	0.90	1.0	1.16	1.28	

4. Typical values presented in the above table were obtained by measurements using RF probes in a 50  $\Omega$  system.

5.  $P_{OUT}$  dBm, Tone Spacing = 1 MHz

### Electrical Specifications<sup>6,7</sup>: 2 GHz ( $T_A = +25^\circ\text{C}$ , $V_{DD} = 3 \text{ V}$ , $Z_0 = 50 \Omega$ )

Parameter	Units	Min.	Typ.	Max.
Small Signal Gain	dB	12.5	14.3	-
Output IP3	dBm	-	34.5	-
Output P1dB	dBm	17.0	18.6	-
Quiescent Current	mA	-	60.0	75.0
Noise Figure	dB	-	0.95	-

6. Unless otherwise specified, the specifications are guaranteed at room temperature in a MACOM test fixture.

7. Typical values presented in the above table are based on data from multiple wafer lots and evaluation board MAAL-010570-001SMB.

## Absolute Maximum Ratings<sup>8,9</sup>

Parameter	Absolute Max.
Supply Voltage	5.5 V
Current	100 mA
Bias Current	15 mA
Power Dissipation	600 mW
RF Input Power	24 dBm
Storage Temperature	-55°C to +150°C
Operating Temperature	-40°C to +85°C
Junction Temperature	+150°C
Thermal Resistance	+104°C/W

8. Exceeding any one or combination of these limits may cause permanent damage to this device.
9. MACOM does not recommend sustained operation near these survivability limits.

## Evaluation Board

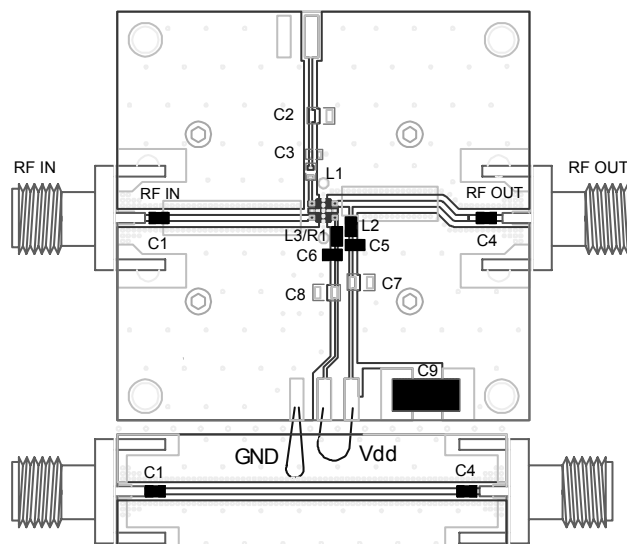

## Evaluation Board Schematic

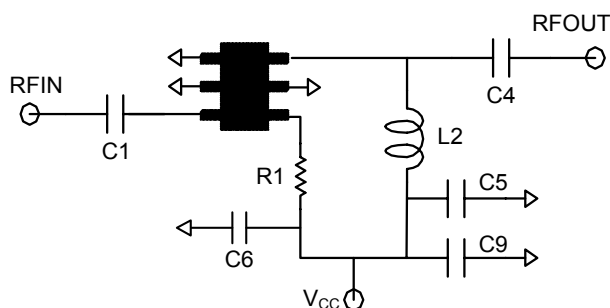

## Component Values

Part	Value	Case Style
C1, C4, C5	1 nF	0402
C6	10 nF	0402
C9	100 $\mu$ F tantalum	size C
L2	82 nH	0402
L3 or R1 <sup>10</sup>	Please refer to $R_{BIAS}$ vs. $I_{DQ}$ plot to select the appropriate R1 value	
C2, C3, C7, C8, L1, L3	Do not populate	

10.  $V_{BIAS}$  can be connected separate of  $V_{DD}$  to control the drain current. When  $V_{BIAS}$  is connected directly either a resistor is used to drop the voltage down from 3 V, or if the exact bias voltage ( $\sim 2$  V) is applied, then an inductor L3 can be used.

## Typical Performance: $R_{BIAS}$ vs. Current<sup>11</sup>

**IDQ vs.  $R_{BIAS}$  @ 3 V**

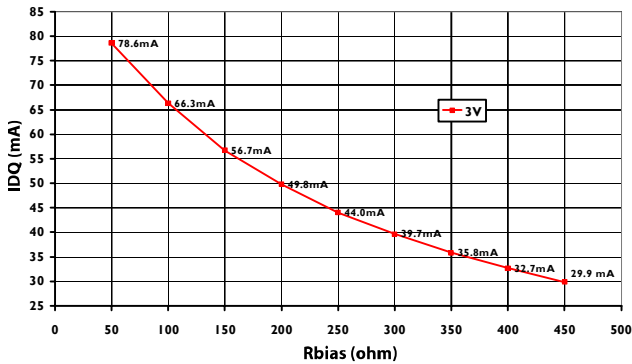

**IDQ vs.  $R_{BIAS}$  @ 5 V**

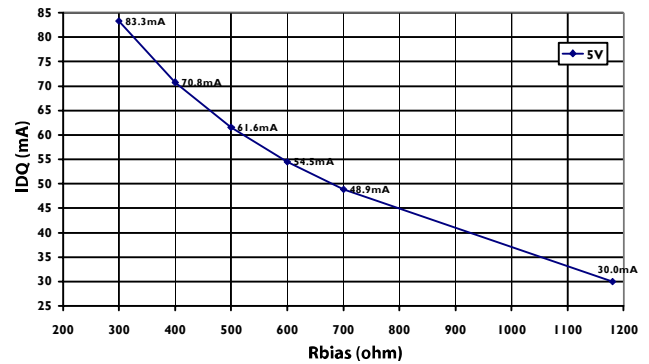

11. IDQ represents the total current of drain current ( $I_{DD}$ ) and bias current ( $I_{BIAS}$ ) combined. The resistor ( $R_{BIAS}$ ) is connected between pin 4 ( $V_{BIAS}$ ) and pin 6 (RF out /  $V_{DD}$ ).

## Typical Performance<sup>12</sup>: Total Current vs. $P_{OUT}$ vs. Voltage

**IDQ = 30 mA**

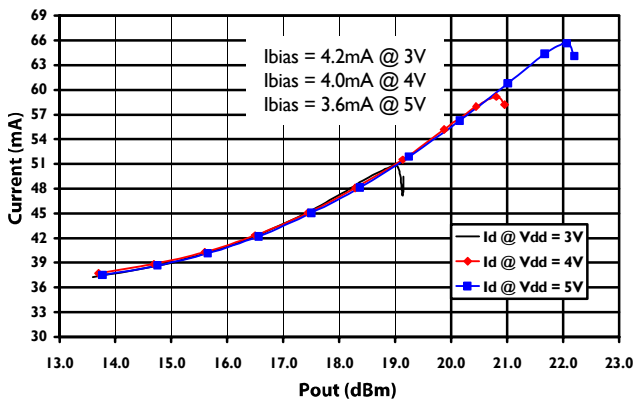

**IDQ = 60 mA**

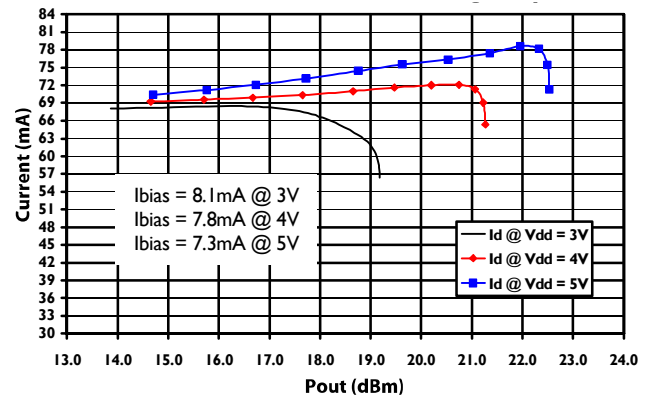

Typical Performance Curves<sup>12</sup>: 3 V, 30 mA (over temperature)

Input Return Loss

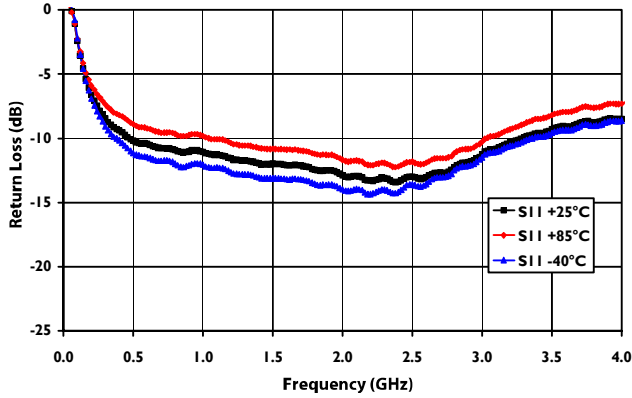

Output Return Loss

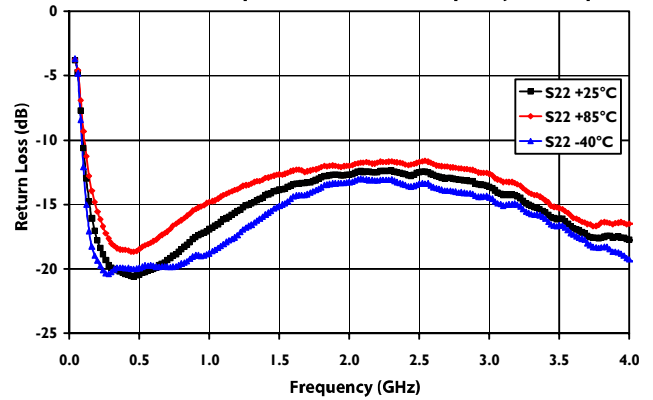

Gain

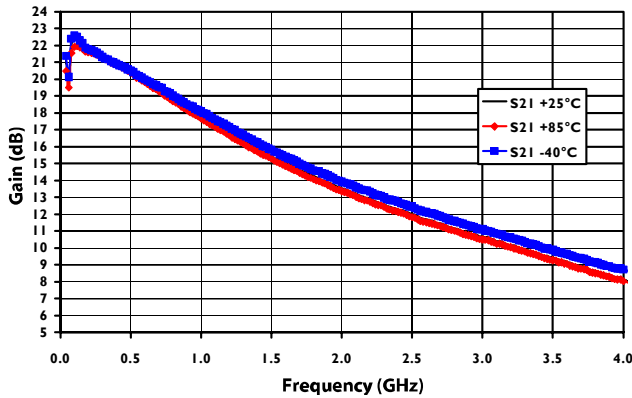

Noise Figure

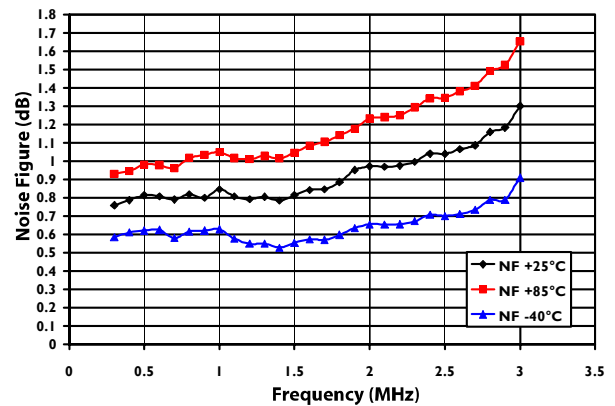

OIP3

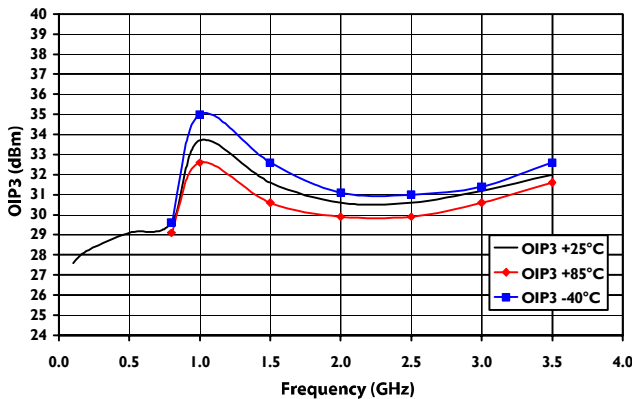

P1dB

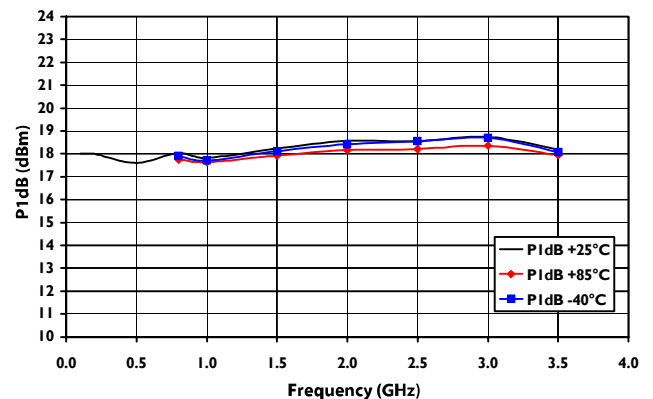

## Low Noise Amplifier 0.1 - 3.5 GHz

Rev. V3

### Typical Performance Curves<sup>12</sup>: 3 V, 60 mA (over temperature)

**Input Return Loss**

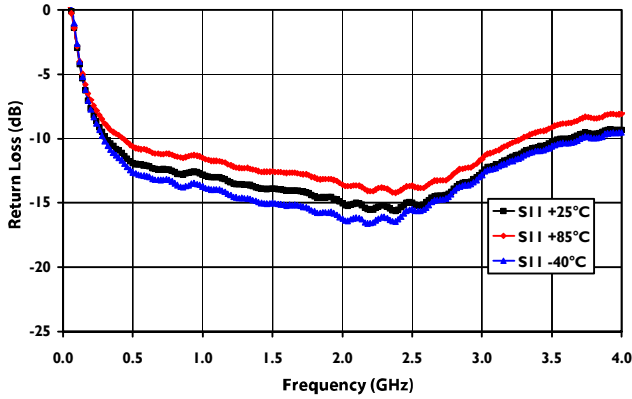

**Output Return Loss**

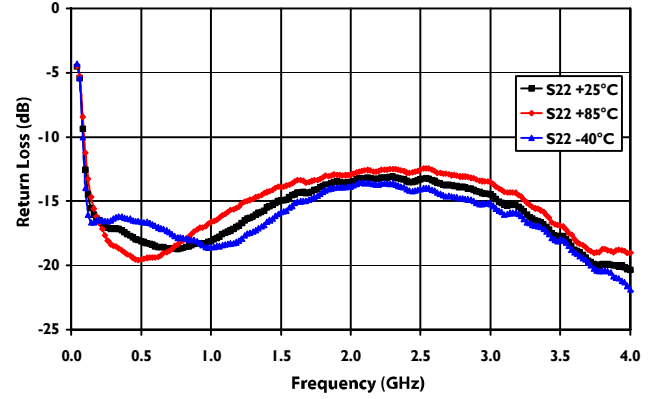

**Gain**

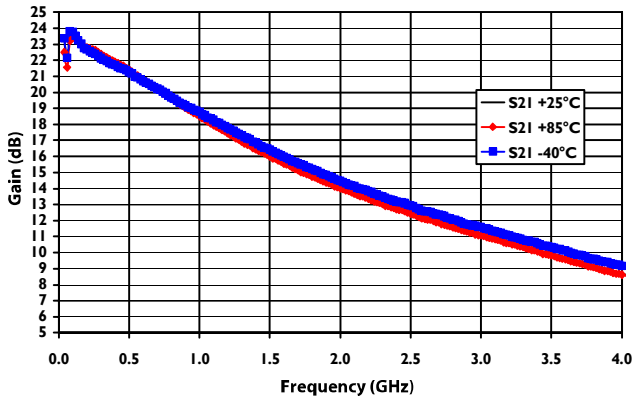

**Noise Figure**

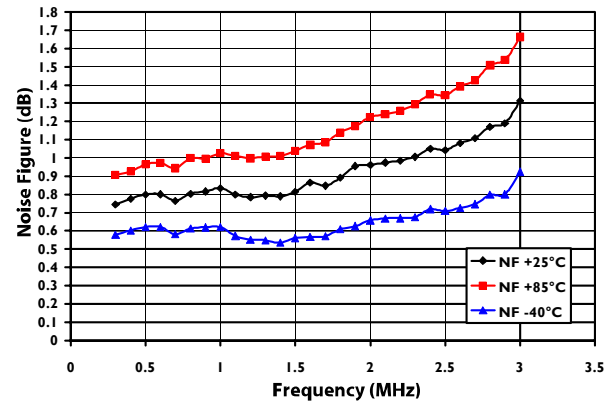

**OIP3**

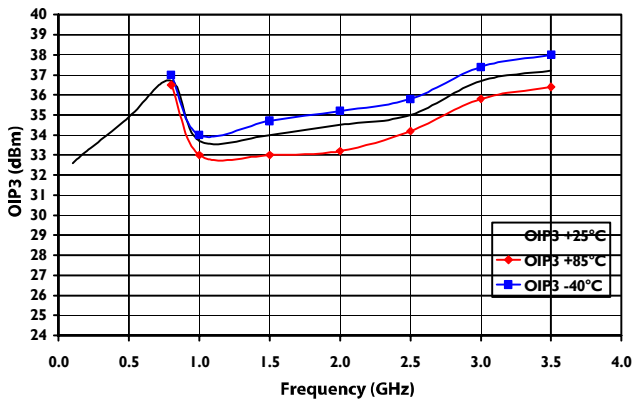

**P1dB**

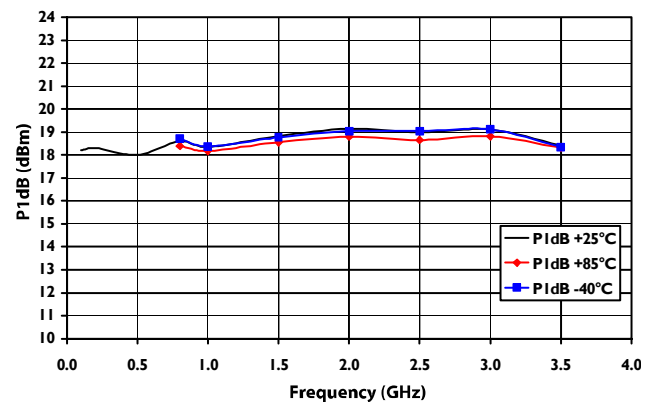

## Low Noise Amplifier 0.1 - 3.5 GHz

Rev. V3

### Typical Performance Curves<sup>12</sup>: 5 V, 30 mA (over temperature)

**Input Return Loss**

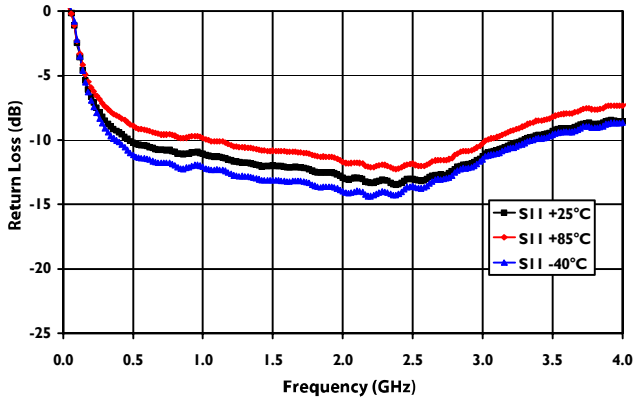

**Output Return Loss**

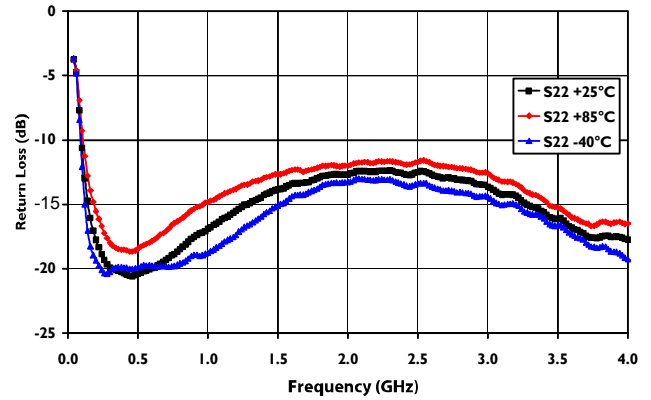

**Gain**

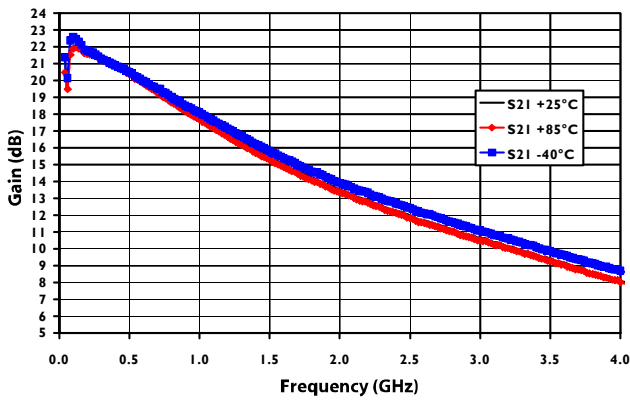

**Noise Figure**

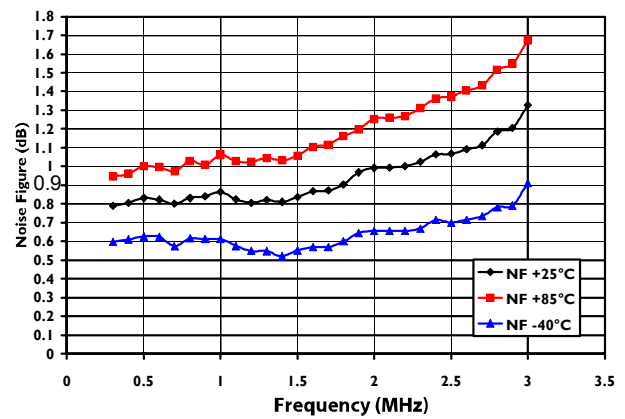

**OIP3**

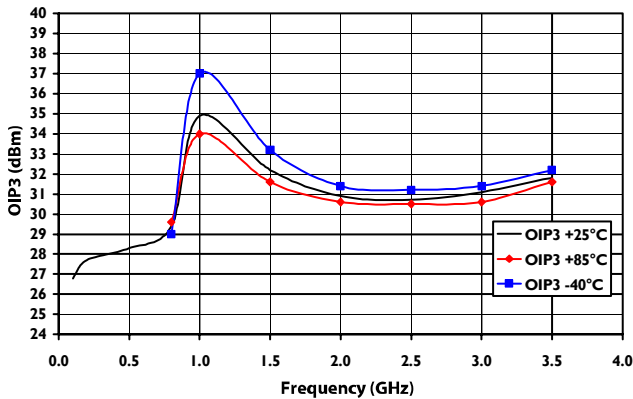

**P1dB**

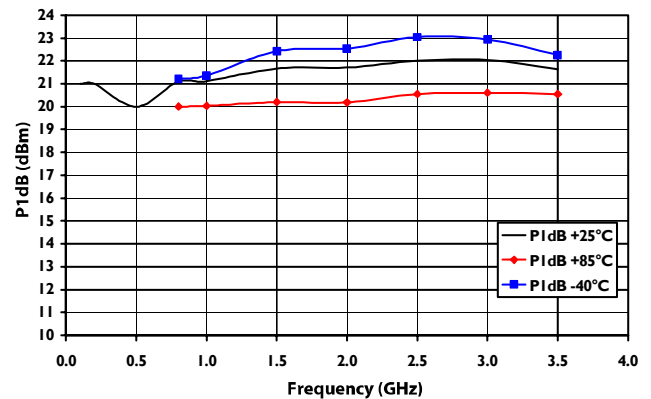

## Typical Performance Curves<sup>12</sup>: 5 V, 60 mA (over temperature)

**Input Return Loss**

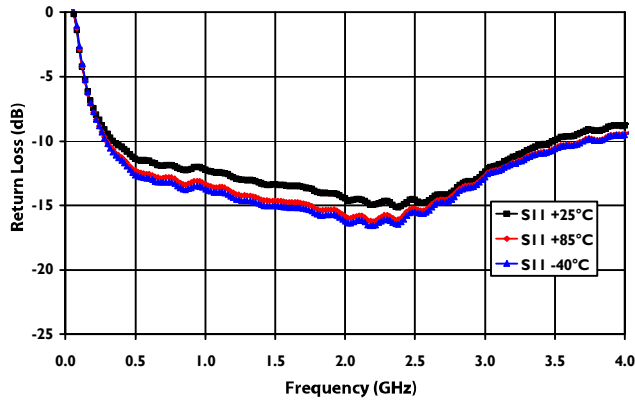

**Output Return Loss**

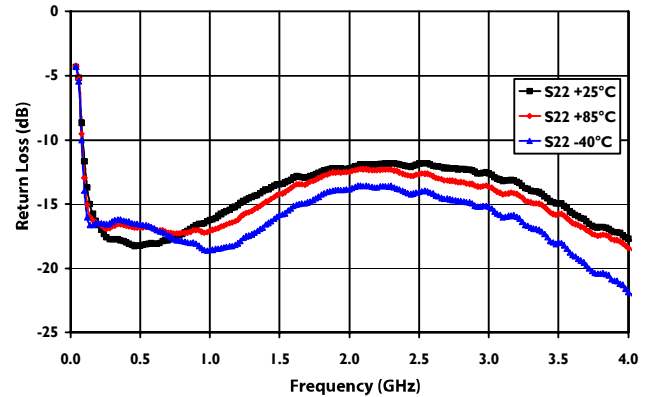

**Gain**

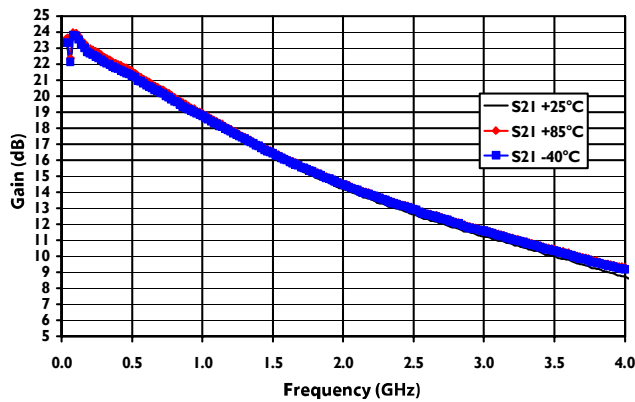

**Noise Figure**

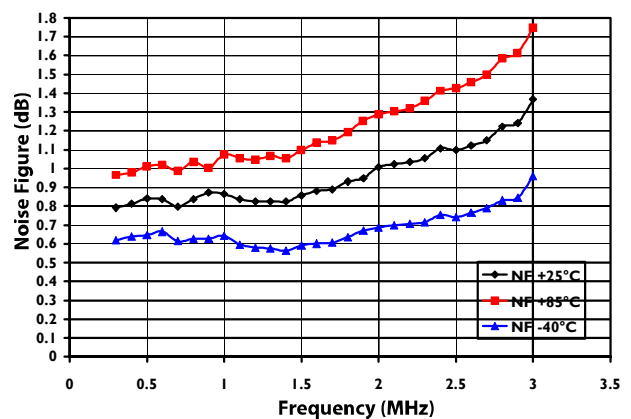

**OIP3**

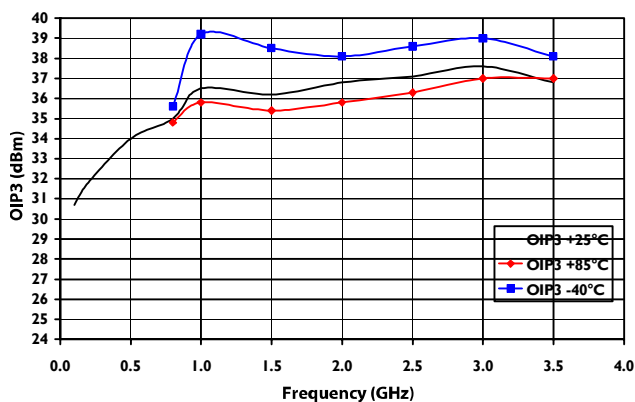

**P1dB**

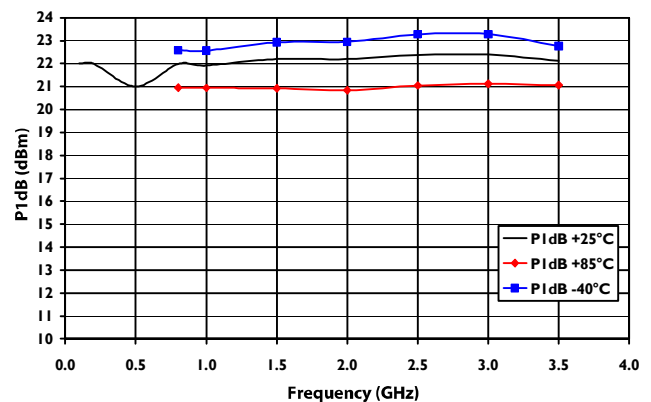

12. Graphs were generated using evaluation board MAAL-010570-001SMB.



## Typical S-Parameters<sup>13</sup>

Reverse Isolation

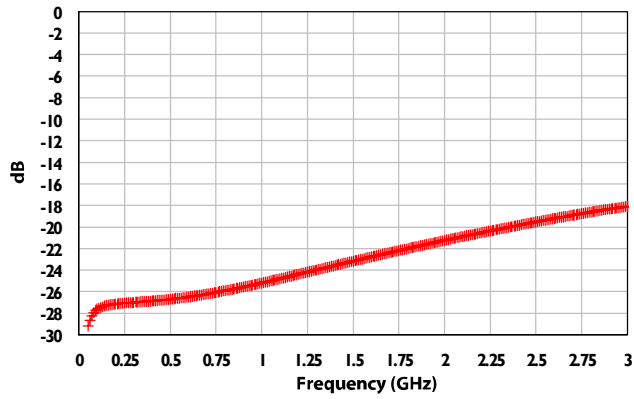

Gain

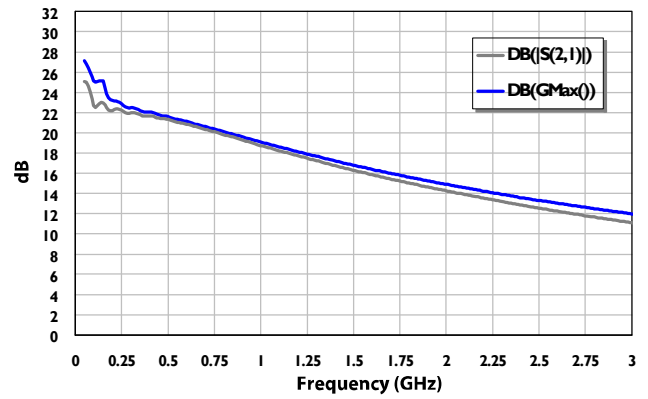

Output Return Loss

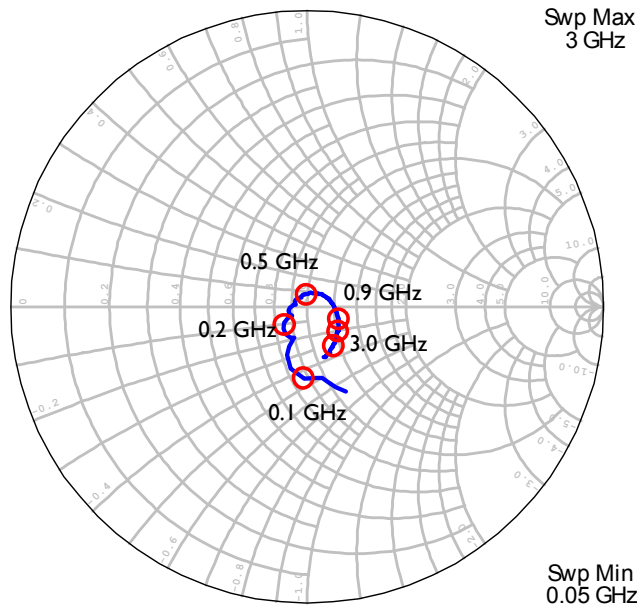

Input Return Loss

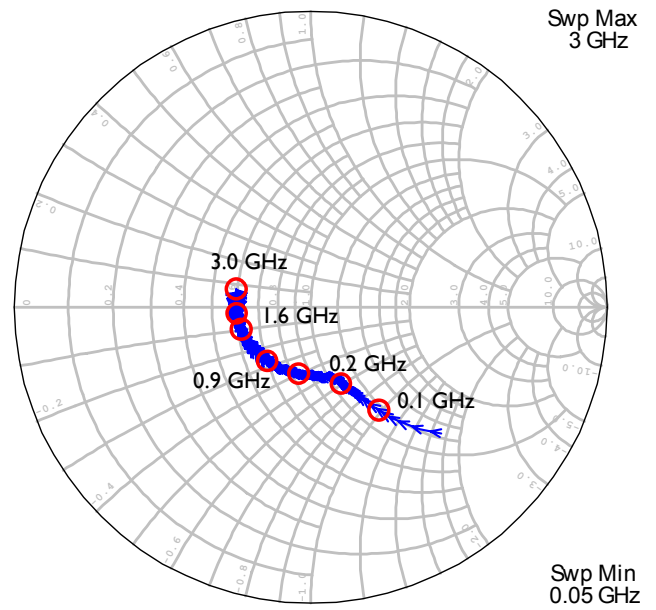

13. S-Parameters files in S2P format are available for download at [macomtech.com](http://macomtech.com).

### Evaluation Board Schematic @ 100 MHz

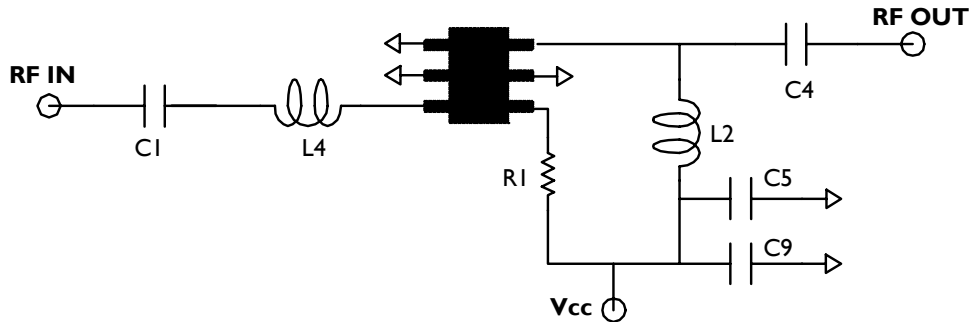

### Typical Performance: 3 V, 60 mA

Parameter	Units	TYP
Frequency	GHz	0.1
Gain	dB	25.5
Output IP3 <sup>14</sup>	dBm	31.5
Output P1dB	dBm	17.5
Input Return Loss	dB	11.0
Output Return Loss	dB	11.0
Noise Figure	dB	1.85

### Component Values

Ref Designator	Description
C1, C4	1 nF 0402 Capacitor
C5	10 nF 0402 Capacitor
C9	100 $\mu$ F Tantalum Capacitor Size C
L2	150 nH 0603 Inductor
L4	68 nH 0402 Inductor
R1	Refer to R <sub>BIAS</sub> vs. I <sub>DD</sub> plot
C2, C3, C6, C7, C8, L1, L3	DNP

14. P<sub>OUT</sub> = 5 dBm, Tone Spacing = 1 MHz

### S-Parameters using 100 MHz evaluation board

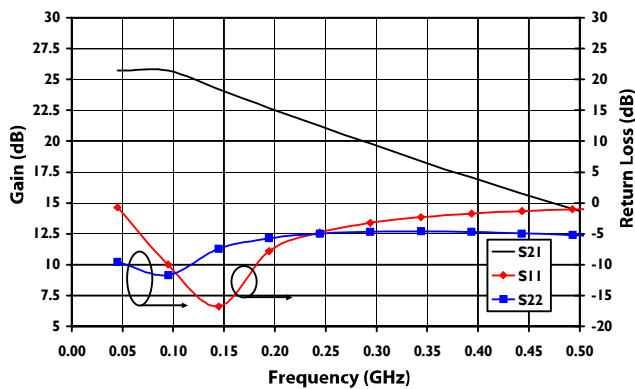

## Evaluation Board Schematic @ 200 MHz

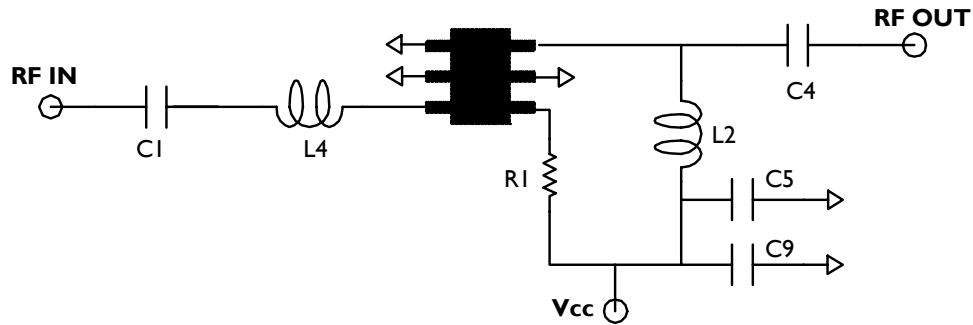

### Typical Performance: 3 V, 60 mA

Parameter	Units	TYP
Frequency	GHz	0.2
Gain	dB	23.0
Output IP3 <sup>15</sup>	dBm	33.5
Output P1dB	dBm	18.4
Input Return Loss	dB	20.0
Output Return Loss	dB	14.0
Noise Figure	dB	1.1

### Component Values

Ref Designator	Description
C1, C4	1 nF 0402 Capacitor
C5	10 nF 0402 Capacitor
C9	100 $\mu$ F Tantalum Capacitor Size C
L2	150 nH 0603 Inductor
L4	24 nH 0402 Inductor
R1	Refer to Rbias Vs Idd plot
C2, C3, C6, C7, C8, L1, L3	DNP

15. P<sub>OUT</sub> = 5 dBm, Tone Spacing = 1 MHz

### S-Parameters using 200 MHz evaluation board

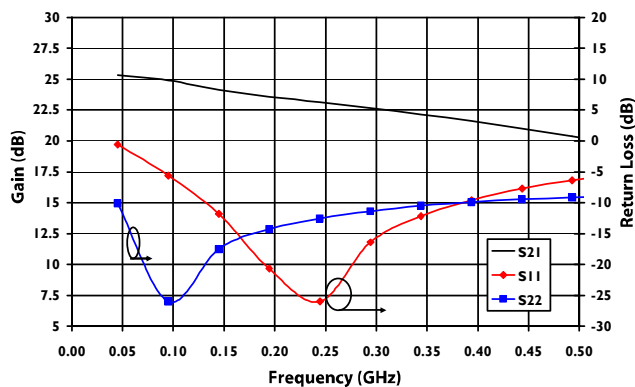

Typical Noise Parameters:  $V_D = 3\text{ V}$ ,  $+25^\circ\text{C}$ ,  $Z_0 = 50\ \Omega$

$I_D = 20\text{ mA}$

Freq (GHz)	NF <sub>min</sub> (dB)	$\Gamma_{opt}$ Mag.	$\Gamma_{opt}$ Ang.	R <sub>n/50</sub>	NF <sub>50Ω</sub> (dB)
0.80	0.80	0.08	136.5	0.08	0.81
0.90	0.77	0.11	133.6	0.07	0.78
1.00	0.78	0.12	132.5	0.08	0.78
1.50	0.81	0.17	-176.6	0.06	0.82
2.00	0.88	0.31	-156.0	0.06	0.89
2.50	0.96	0.32	-139.3	0.08	0.97
3.00	1.12	0.35	-108.1	0.13	1.13
3.50	1.26	0.40	-93.6	0.19	1.28
4.00	1.33	0.43	-64.1	0.36	1.36

$I_D = 30\text{ mA}$

Freq (GHz)	NF <sub>min</sub> (dB)	$\Gamma_{opt}$ Mag.	$\Gamma_{opt}$ Ang.	R <sub>n/50</sub>	NF <sub>50Ω</sub> (dB)
0.80	0.77	0.07	153.4	0.07	0.77
0.90	0.73	0.10	145.8	0.07	0.74
1.00	0.75	0.12	145.3	0.07	0.75
1.50	0.76	0.16	-168.2	0.07	0.76
2.00	0.84	0.31	-155.7	0.06	0.85
2.50	0.92	0.32	-135.2	0.08	0.93
3.00	1.07	0.32	-104.9	0.14	1.08
3.50	1.20	0.37	-92.3	0.20	1.21
4.00	1.29	0.44	-61.6	0.33	1.31

$I_D = 60\text{ mA}$

Freq (GHz)	NF <sub>min</sub> (dB)	$\Gamma_{opt}$ Mag.	$\Gamma_{opt}$ Ang.	R <sub>n/50</sub>	NF <sub>50Ω</sub> (dB)
0.80	0.76	0.07	160.5	0.07	0.76
0.90	0.73	0.09	150.5	0.07	0.73
1.00	0.74	0.12	154.2	0.07	0.74
1.50	0.75	0.17	-158.5	0.07	0.76
2.00	0.84	0.29	-151.8	0.06	0.85
2.50	0.93	0.30	-129.9	0.08	0.94
3.00	1.09	0.31	-99.9	0.14	1.10
3.50	1.21	0.43	-88.5	0.19	1.22
4.00	1.31	0.44	-60.0	0.32	1.33

Typical Noise Parameters:  $V_D = 5\text{ V}$ ,  $+25^\circ\text{C}$ ,  $Z_0 = 50\ \Omega$

$I_D = 20\text{ mA}$

Freq (GHz)	NF <sub>min</sub> (dB)	$\Gamma_{opt}$ Mag.	$\Gamma_{opt}$ Ang.	R <sub>n/50</sub>	NF <sub>50Ω</sub> (dB)
0.80	0.81	0.08	135.0	0.08	0.81
0.90	0.78	0.11	132.0	0.08	0.78
1.00	0.78	0.11	129.4	0.08	0.79
1.50	0.81	0.17	-175.2	0.07	0.81
2.00	0.89	0.30	-161.9	0.06	0.89
2.50	0.97	0.32	-139.7	0.08	0.97
3.00	1.14	0.34	-109.3	0.14	1.15
3.50	1.23	0.40	-92.9	0.21	1.25
4.00	1.33	0.44	-65.7	0.34	1.36

$I_D = 30\text{ mA}$

Freq (GHz)	NF <sub>min</sub> (dB)	$\Gamma_{opt}$ Mag.	$\Gamma_{opt}$ Ang.	R <sub>n/50</sub>	NF <sub>50Ω</sub> (dB)
0.80	0.78	0.07	148.4	0.08	0.79
0.90	0.75	0.10	142.0	0.07	0.76
1.00	0.77	0.12	142.6	0.07	0.78
1.50	0.78	0.16	-165.7	0.07	0.79
2.00	0.87	0.30	-156.3	0.06	0.87
2.50	0.95	0.32	-135.2	0.08	0.96
3.00	1.10	0.32	-105.6	0.14	1.11
3.50	1.23	0.41	-89.1	0.20	1.25
4.00	1.31	0.47	-62.1	0.31	1.33

$I_D = 60\text{ mA}$

Freq (GHz)	NF <sub>min</sub> (dB)	$\Gamma_{opt}$ Mag.	$\Gamma_{opt}$ Ang.	R <sub>n/50</sub>	NF <sub>50Ω</sub> (dB)
0.80	0.81	0.09	153.5	0.08	0.81
0.90	0.77	0.09	149.7	0.08	0.78
1.00	0.78	0.11	149.3	0.08	0.79
1.50	0.81	0.16	-160.0	0.07	0.81
2.00	0.90	0.30	-151.6	0.06	0.90
2.50	0.99	0.30	-130.2	0.09	1.00
3.00	1.16	0.31	-100.7	0.15	1.17
3.50	1.28	0.38	-88.1	0.23	1.30
4.00	1.37	0.43	-57.8	0.36	1.40

**Lead-Free SC70-6LD (SOT-363)<sup>†</sup>**

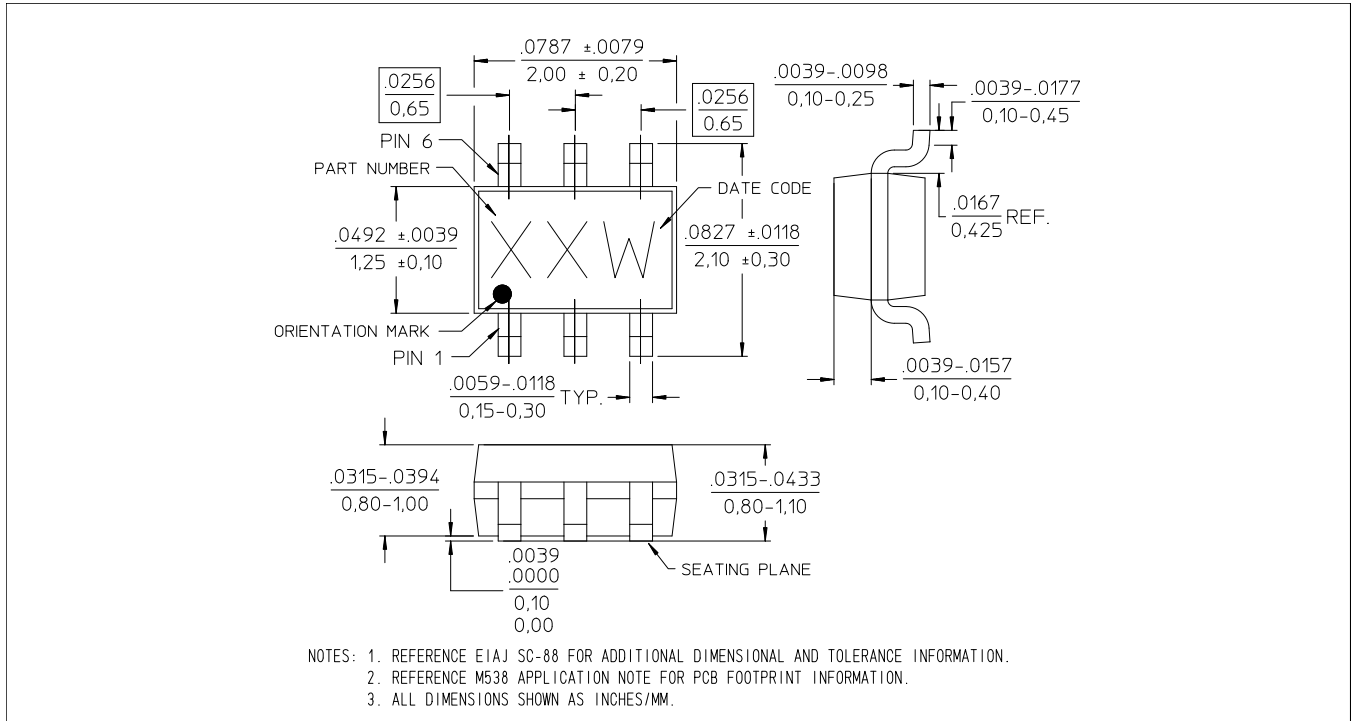

<sup>†</sup> Reference Application Note M538 for lead-free solder reflow recommendations.  
Meets JEDEC moisture sensitivity level 1 requirements.  
Plating is 100% matte tin over copper.

## Handling Procedures

Please observe the following precautions to avoid damage:

## Static Sensitivity

Gallium Arsenide Integrated Circuits are sensitive to electrostatic discharge (ESD) and can be damaged by static electricity. Proper ESD control techniques should be used when handling these class 1A devices.

M/A-COM Technology Solutions Inc. All rights reserved.

Information in this document is provided in connection with M/A-COM Technology Solutions Inc ("MACOM") products. These materials are provided by MACOM as a service to its customers and may be used for informational purposes only. Except as provided in MACOM's Terms and Conditions of Sale for such products or in any separate agreement related to this document, MACOM assumes no liability whatsoever. MACOM assumes no responsibility for errors or omissions in these materials. MACOM may make changes to specifications and product descriptions at any time, without notice. MACOM makes no commitment to update the information and shall have no responsibility whatsoever for conflicts or incompatibilities arising from future changes to its specifications and product descriptions. No license, express or implied, by estoppel or otherwise, to any intellectual property rights is granted by this document.

THESE MATERIALS ARE PROVIDED "AS IS" WITHOUT WARRANTY OF ANY KIND, EITHER EXPRESS OR IMPLIED, RELATING TO SALE AND/OR USE OF MACOM PRODUCTS INCLUDING LIABILITY OR WARRANTIES RELATING TO FITNESS FOR A PARTICULAR PURPOSE, CONSEQUENTIAL OR INCIDENTAL DAMAGES, MERCHANTABILITY, OR INFRINGEMENT OF ANY PATENT, COPYRIGHT OR OTHER INTELLECTUAL PROPERTY RIGHT. MACOM FURTHER DOES NOT WARRANT THE ACCURACY OR COMPLETENESS OF THE INFORMATION, TEXT, GRAPHICS OR OTHER ITEMS CONTAINED WITHIN THESE MATERIALS. MACOM SHALL NOT BE LIABLE FOR ANY SPECIAL, INDIRECT, INCIDENTAL, OR CONSEQUENTIAL DAMAGES, INCLUDING WITHOUT LIMITATION, LOST REVENUES OR LOST PROFITS, WHICH MAY RESULT FROM THE USE OF THESE MATERIALS.

MACOM products are not intended for use in medical, lifesaving or life sustaining applications. MACOM customers using or selling MACOM products for use in such applications do so at their own risk and agree to fully indemnify MACOM for any damages resulting from such improper use or sale.