

Features

- 1.6 dB Noise Figure
- Single 4 V Bias @ 60 mA
- Fully Internally Matched to 50 Ω
- Lead-Free 3 mm 16-Lead PQFN Package
- Halogen-Free “Green” Mold Compound
- RoHS* Compliant

Description

The MAAL-010528 is a high performance X-band GaAs LNA, housed in a miniature, lead-free 3 mm PQFN surface mount plastic package. This MMIC operates from 8 to 12 GHz providing a nominal gain of 20 dB with excellent gain flatness, high OIP3 linearity of 26 dBm, and a mid-band noise figure of 1.6 dB. The part features a self-bias architecture which requires only a single, positive supply.

The device is internally matched to 50 Ω input/output and is well suited to multiple applications including V_{SAT} , radar and microwave radios due to the part’s ease of use and excellent performance parameters.

Ordering Information ^{1,2}

Part Number	Package
MAAL-010528-TR0500	500 piece reel
MAAL-010528-001SMB	Sample Board

1. Reference Application Note M513 for reel size information.
2. All sample boards include 5 loose parts.

Functional Schematic

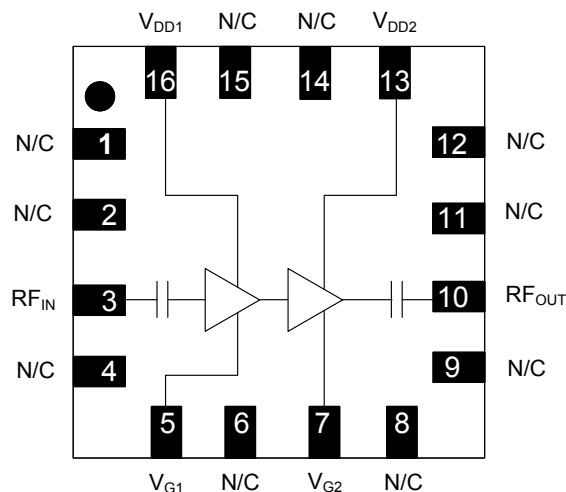

Pin Configuration

Pin #	Pin Name	Description
1, 2	N/C	No Connection
3	RF _{IN}	RF Input
4	N/C	No Connection
5 ^{3,4}	V _{G1}	Gate Voltage 1
6	N/C	No Connection
7 ^{3,4}	V _{G2}	Gate Voltage 2
8, 9	N/C	No Connection
10	RF _{OUT}	RF Output
11, 12	N/C	No Connection
13	V _{DD2}	Bias Voltage 2
14, 15	N/C	No Connection
16	V _{DD1}	Bias Voltage 1
Paddle ⁵		RF and DC Ground

3. For self-bias, external components C7 through C12 are optional. No V_G bias is needed. If C7 through C12 are removed, traces must also be removed.
4. For optional adjustment of self-bias, apply DC gate voltage between -1 V and +0.3 V. External components C7 through C12 are required.
5. The exposed pad centered on the package bottom must be connected to RF, DC and thermal ground.

* Restrictions on Hazardous Substances, European Union Directive 2011/65/EU.

Electrical Specifications: $T_A = 25^\circ\text{C}$, $V_{DD} = 4\text{ V}$, $Z_0 = 50\ \Omega$

Parameter	Test Conditions	Units	Min.	Typ.	Max.
Gain	8 - 12 GHz	dB	17.5	20	—
Noise figure	8 GHz 10 GHz 12 GHz	dB	—	1.5 1.8 2.1	2.0 2.3 2.8
Input Return Loss	8 - 12 GHz	dB	—	10	—
Output Return Loss	8 - 12 GHz	dB	—	13	—
P1dB	8 - 12 GHz	dBm	—	14	—
OIP3	8 - 12 GHz	dBm	—	26	—
Current	—	mA	—	60	75

Absolute Maximum Ratings^{6,7}

Parameter	Absolute Maximum
Input Power	22 dBm
Operating Voltage	6 V
Operating Temperature	-40°C to +85°C
Storage Temperature	-65°C to +150°C

- 6. Exceeding any one or combination of these limits may cause permanent damage to this device.
- 7. MACOM does not recommend sustained operation near these survivability limits.

Handling Procedures

Please observe the following precautions to avoid damage:

Static Sensitivity

Gallium Arsenide Integrated Circuits are sensitive to electrostatic discharge (ESD) and can be damaged by static electricity. Proper ESD control techniques should be used when handling these HBM Class 1B devices.

Recommended PCB⁸

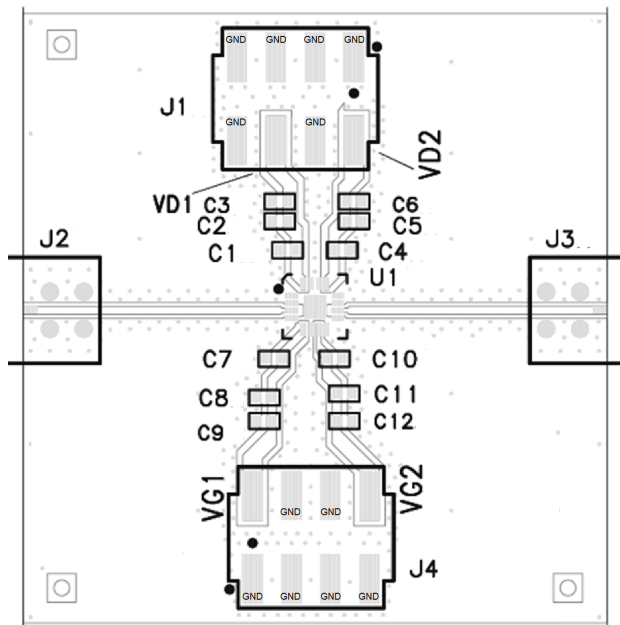

Application Schematic^{9,10}

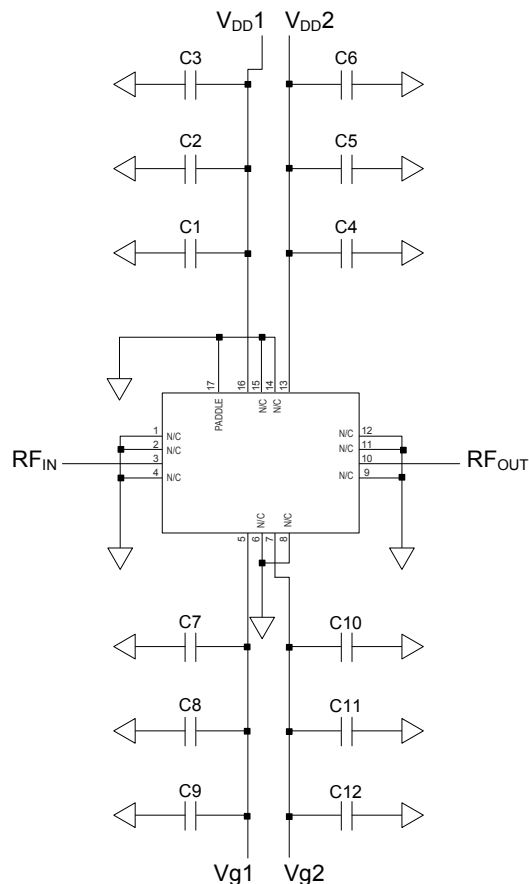

Recommended Grounding Under Device⁸

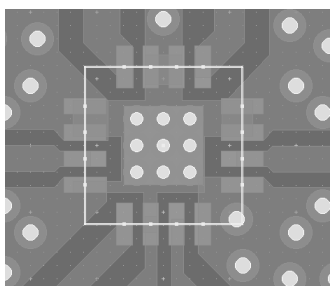

8. For best performance, ensure proper grounding at the device. Recommended grounding is 9 vias beneath the ground paddle, each with 10-mil diameter. Contact MACOM technical support for recommended PCB layout details.

9. For self-bias, external components C7 through C12 are optional. No V_G bias is needed. If C7 through C12 are removed, traces must also be removed. When using self-bias, leave V_{G1} and V_{G2} pins open (do not ground).
10. For optional adjustment of self-bias, apply DC gate voltage between -1 V and +0.3 V. External components C7 through C12 are required.

Parts List

Component	Value	Package
C1, C4, C7, C10	2.2 pF	0402
C2, C5, C8, C11	100 pF	0402
C3, C6, C9, C12	0.01 μ F	0402

X-Band Low Noise Amplifier 8 - 12 GHz

Rev. V6

Typical Performance Curves

Wide-Band Gain and Return Loss

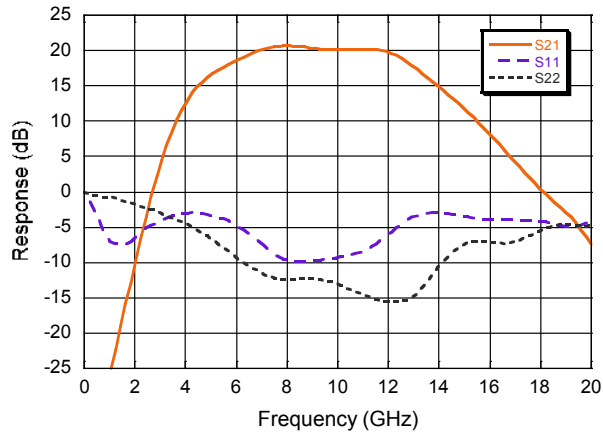

Small-Signal Gain vs. Temperature

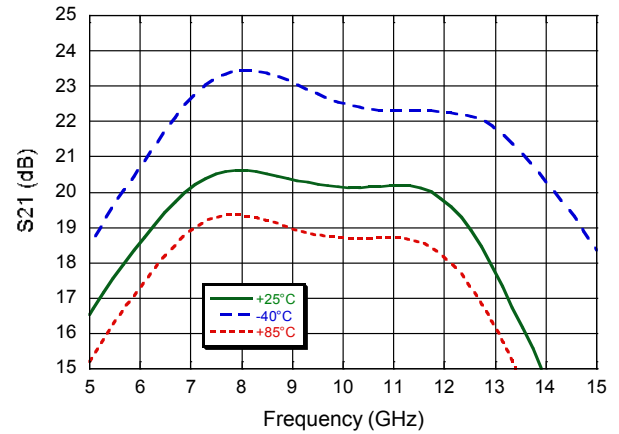

Input Return Loss vs. Temperature

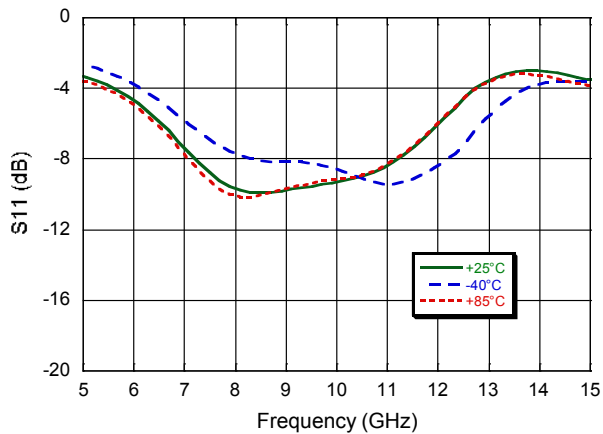

Output Return Loss vs. Temperature

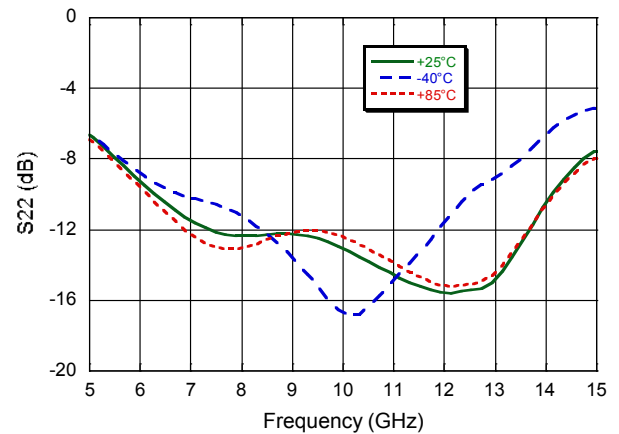

Noise Figure vs. Temperature

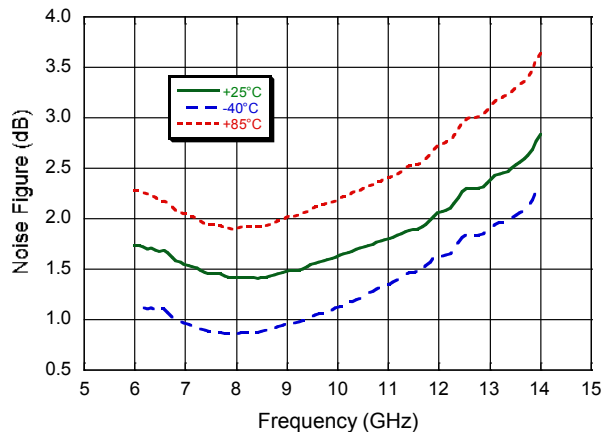

Noise Figure vs. Supply Voltage

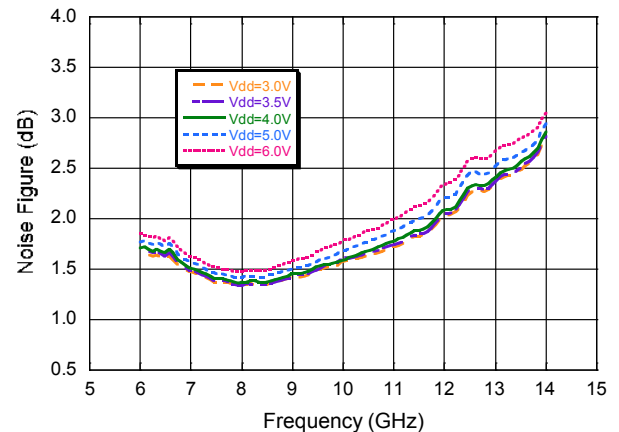

Typical Performance Curves

Small-Signal Gain vs. Supply Voltage

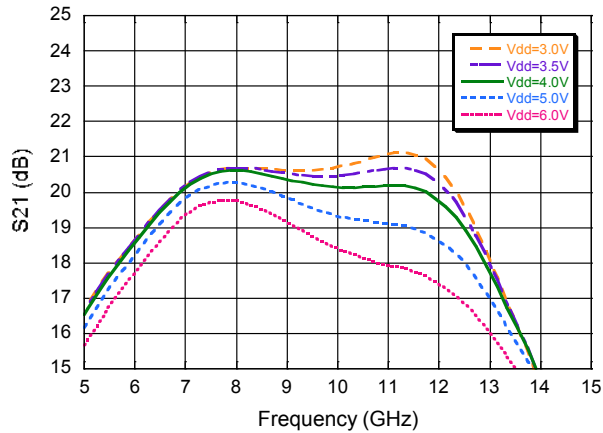

Input Return Loss vs. Supply Voltage

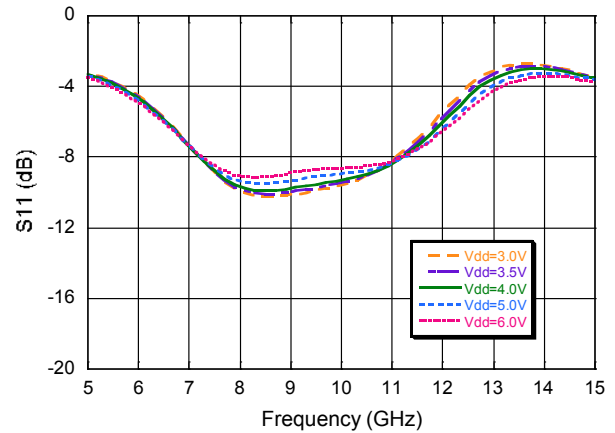

Output Return Loss vs. Supply Voltage

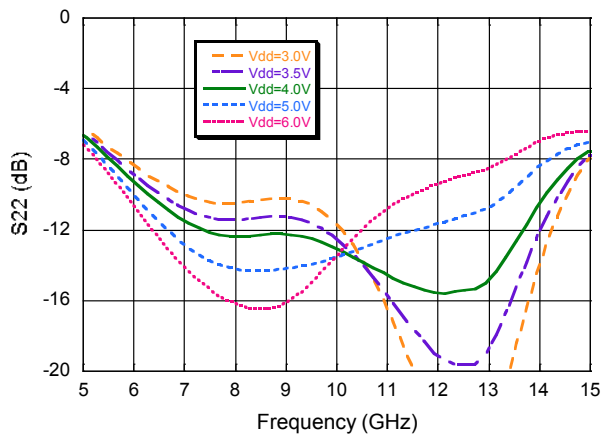

P1dB vs. Temperature

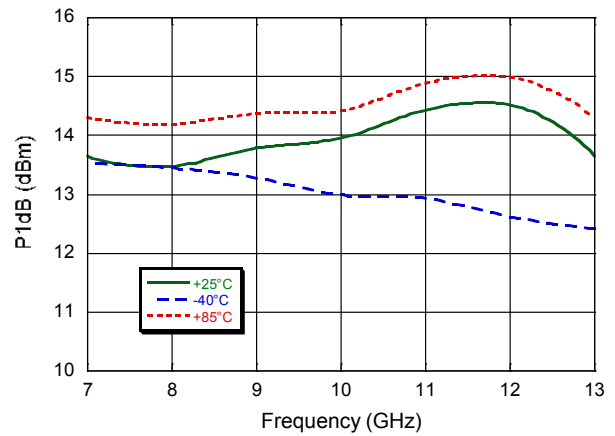

Large-Signal Gain vs. Voltage @ 10 GHz

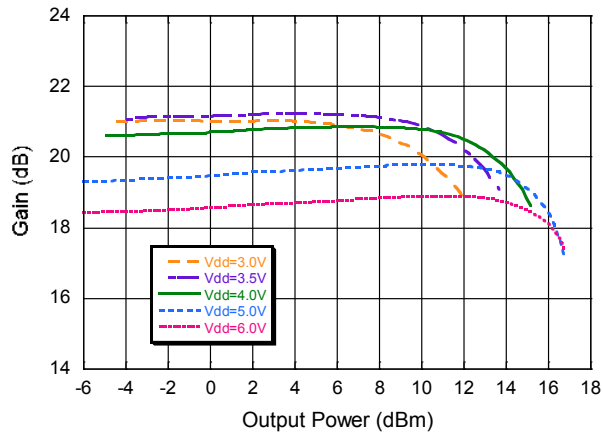

Large-Signal Gain vs. Temperature @ 10 GHz

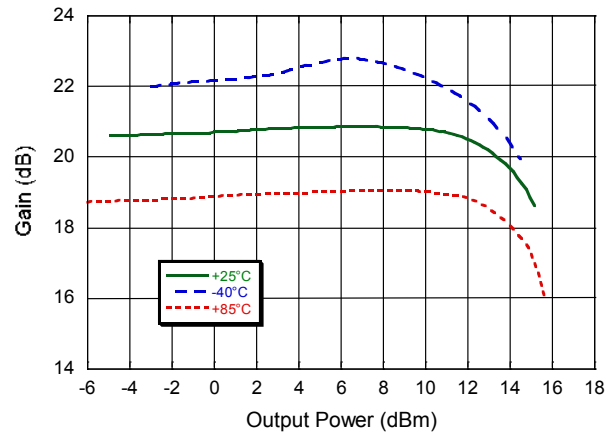

Typical Performance Curves

Output IP3 vs. Supply Voltage

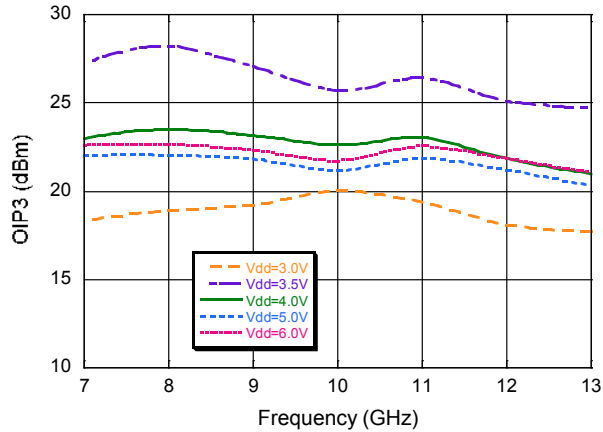

Output IP3 vs. Temperature @ 10 GHz

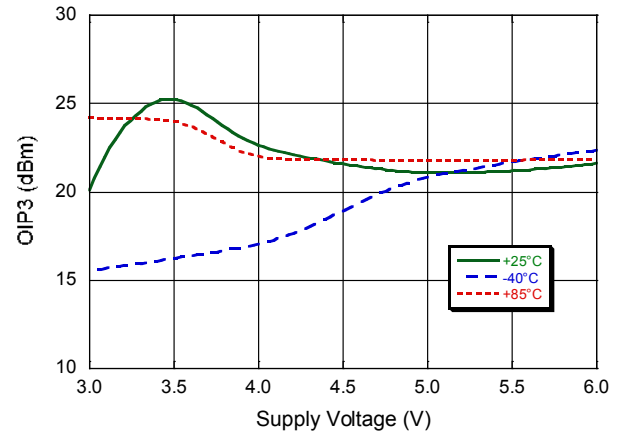

Output IP3 vs. Temperature for $V_{DD} = 3\text{ V}$

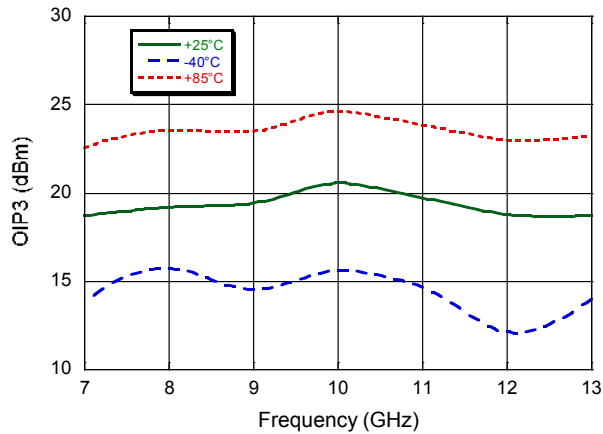

Output IP3 vs. Temperature for $V_{DD} = 4\text{ V}$

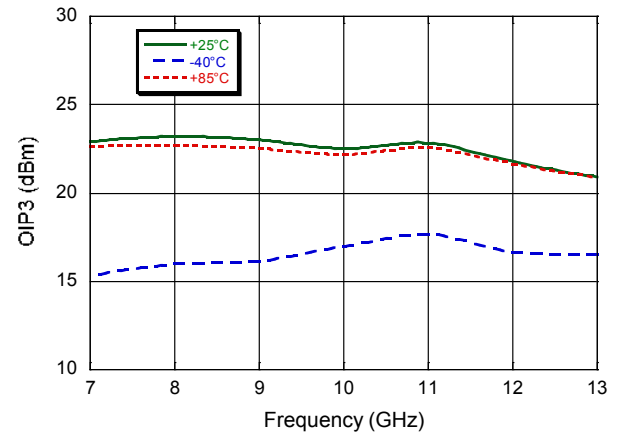

Output IP3 vs. Temperature for $V_{DD} = 5\text{ V}$

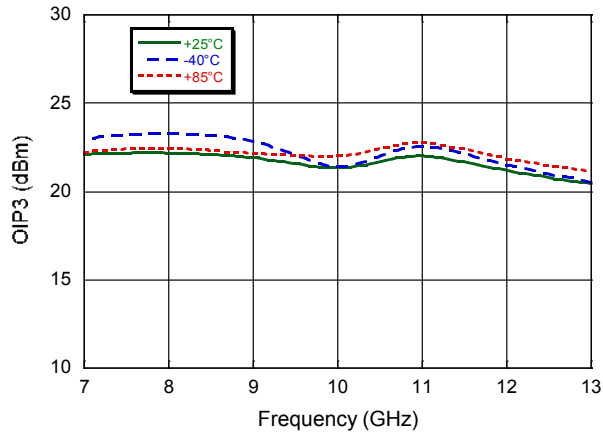

Typical Bias Current vs. Supply Voltage

$V_{DD1} = V_{DD2}$ (V)	I_{DD1} (mA)	I_{DD2} (mA)
3	14.6	43.4
4	15.2	44.5
5	15.6	45.0
6	15.8	45.1

Lead-Free 3 mm 16-Lead PQFN[†]

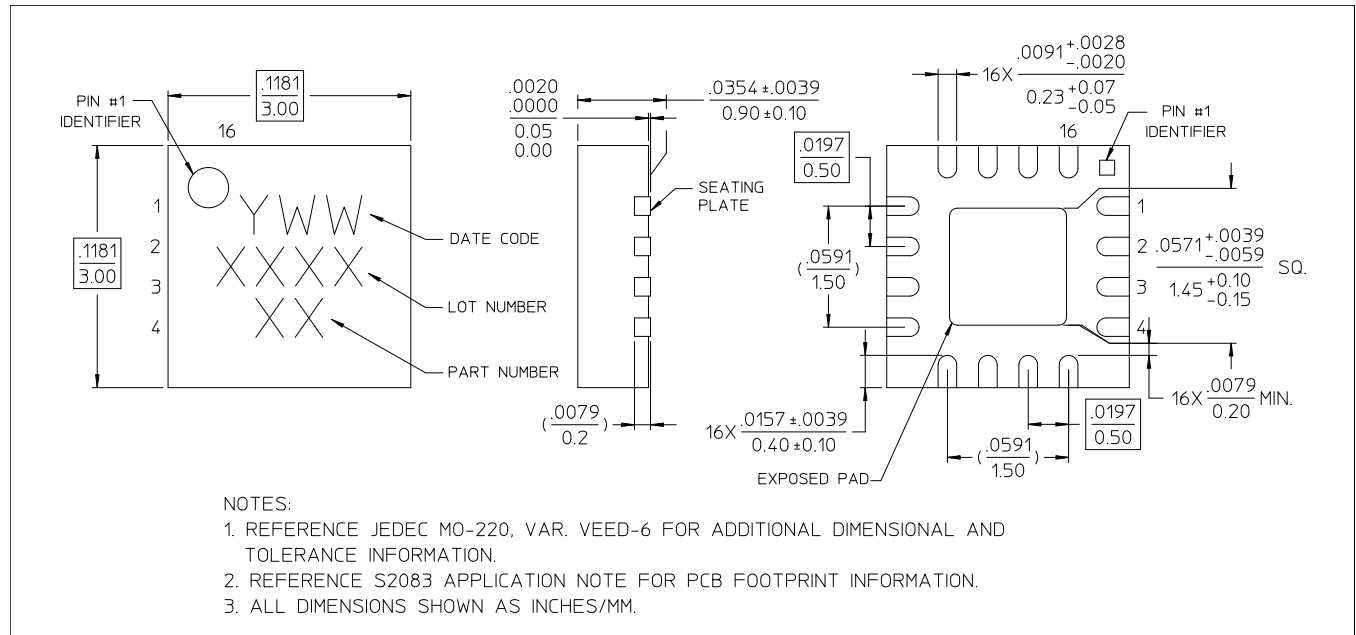

[†] Reference Application Note S2083 for lead-free solder reflow recommendations.
Meets JEDEC moisture sensitivity level 1 requirements.
Plating is 100% matte tin plating over copper.

MACOM Technology Solutions Inc. All rights reserved.

Information in this document is provided in connection with MACOM Technology Solutions Inc ("MACOM") products. These materials are provided by MACOM as a service to its customers and may be used for informational purposes only. Except as provided in MACOM's Terms and Conditions of Sale for such products or in any separate agreement related to this document, MACOM assumes no liability whatsoever. MACOM assumes no responsibility for errors or omissions in these materials. MACOM may make changes to specifications and product descriptions at any time, without notice. MACOM makes no commitment to update the information and shall have no responsibility whatsoever for conflicts or incompatibilities arising from future changes to its specifications and product descriptions. No license, express or implied, by estoppel or otherwise, to any intellectual property rights is granted by this document.

THESE MATERIALS ARE PROVIDED "AS IS" WITHOUT WARRANTY OF ANY KIND, EITHER EXPRESS OR IMPLIED, RELATING TO SALE AND/OR USE OF MACOM PRODUCTS INCLUDING LIABILITY OR WARRANTIES RELATING TO FITNESS FOR A PARTICULAR PURPOSE, CONSEQUENTIAL OR INCIDENTAL DAMAGES, MERCHANTABILITY, OR INFRINGEMENT OF ANY PATENT, COPYRIGHT OR OTHER INTELLECTUAL PROPERTY RIGHT. MACOM FURTHER DOES NOT WARRANT THE ACCURACY OR COMPLETENESS OF THE INFORMATION, TEXT, GRAPHICS OR OTHER ITEMS CONTAINED WITHIN THESE MATERIALS. MACOM SHALL NOT BE LIABLE FOR ANY SPECIAL, INDIRECT, INCIDENTAL, OR CONSEQUENTIAL DAMAGES, INCLUDING WITHOUT LIMITATION, LOST REVENUES OR LOST PROFITS, WHICH MAY RESULT FROM THE USE OF THESE MATERIALS.

MACOM products are not intended for use in medical, lifesaving or life sustaining applications. MACOM customers using or selling MACOM products for use in such applications do so at their own risk and agree to fully indemnify MACOM for any damages resulting from such improper use or sale.