

## Features

- Attenuation: 0.5 dB Steps to 15.5 dB
- Temperature Stability:  $\pm 0.18$  dB from  $-55^{\circ}\text{C}$  to  $+85^{\circ}\text{C}$  Typical
- Low DC Power Consumption
- Hermetic Surface Mount Package
- Integral TTL Driver
- $50\ \Omega$  Nominal Impedance
- Lead-Free CR-12 Package
- $260^{\circ}\text{C}$  Reflow Compatible
- RoHS\* Compliant

## Description

M/A-COM's AT-283-PIN is a GaAs FET 5-bit digital attenuator with a 0.5 dB minimum step size and 15.5 dB total attenuation. This attenuator and integral TTL driver is in a hermetically sealed ceramic 16 lead surface mount package. The AT-283-PIN is ideally suited for use where accuracy, fast switching, very low power consumption and low intermodulation products are required. Typical applications include dynamic range setting in precision receiver circuits and other gain/leveling control circuits. Environmental screening is available. Contact the factory for information.

## Ordering Information

Part Number	Package
AT-283-PIN	Bulk Packaging
MAAD-007229-0001TR	1000 piece reel
MAAD-007229-0001TB	Sample Test Board

Note: Reference Application Note M513 for reel size information.

## Functional Schematic

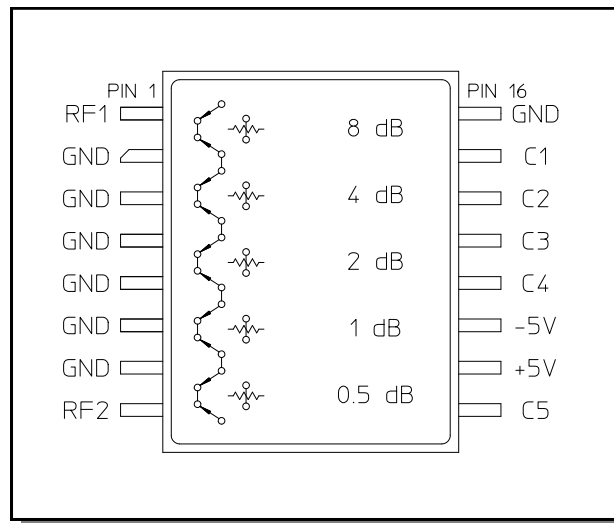

## Pin Configuration

Pin No.	Function	Pin No.	Function
1	RF1	9	C5
2	GND	10	+5V
3	GND	11	-5V
4	GND	12	C4
5	GND	13	C3
6	GND	14	C2
7	GND	15	C1
8	RF2	16	GND

The metal bottom of the case must be connected to RF and DC ground.

**Electrical Specifications:  $T_A = 25^\circ\text{C}^1$**

Parameter	Test Conditions	Units	Min	Typ	Max
Reference Insertion Loss	DC-0.5 GHz	dB	—	—	2.2
	DC-1.0 GHz	dB	—	—	2.5
	DC-2.0 GHz	dB	—	—	2.9
Attenuation Accuracy <sup>2</sup>	Any Single Bit Any Combination of Bits	DC-2.0 GHz DC-2.0 GHz	± (0.25 +3% of attenuation setting in dB) dB ± (0.25 +3% of attenuation setting in dB) dB or ± 0.4 dB, whichever is greater		
VSWR	DC-1.0 GHz	—	—	—	1.6:1
	DC-2.0 GHz	—	—	—	1.7:1
Trise, Tfall Ton, Toff Transients	10% to 90%	nS	—	10	—
	50% Control to 90/10% RF	nS	—	27	—
	In-band (peak—peak)	mV	—	22	—
1 dB Compression <sup>3</sup>	Input Power	0.05 GHz	—	+20	—
	Input Power	0.5-2.0 GHz	—	+28	—
Input IP <sub>3</sub> <sup>3</sup>	For two-tone input power up to +5 dBm	0.05 GHz	—	+40	—
		0.5-2.0 GHz	—	+47	—
Input IP <sub>2</sub> <sup>3</sup>	For two-tone input power up to +5 dBm	0.05 GHz	—	+53	—
		0.5-2.0 GHz	—	+68	—
V <sub>CC</sub>	—	V	4.5	5.0	5.5
V <sub>EE</sub>	—	V	-8.0	—	-5.0
I <sub>CC</sub>	V <sub>CC</sub> = 4.5 to 5.5V V <sub>ctl</sub> = 0 to 0.8V, or V <sub>CC</sub> - 2.1V to V <sub>CC</sub>	mA	—	—	5.0
I <sub>EE</sub>	V <sub>EE</sub> = -5.0 to -8.0V	mA	—	—	1.0
V <sub>ctl</sub>	Logic 0 (TTL)	V	0.0	—	0.8
	Logic 1 (TTL)	V	2.0	—	5.0
Input Leakage Current (Low)	0 to 0.8V	µA	—	—	1.0
Input Leakage Current (High)	2.0 to 5.0V	µA	—	—	1.0

1. All specifications apply when operated with bias voltages of +5.0V for V<sub>CC</sub> and -5.0V to -8.0V for V<sub>EE</sub>, and 50 Ω impedance at all ports unless otherwise specified.
2. This attenuator is guaranteed monotonic.
3. V<sub>EE</sub> = -5.0V for the typical numbers given.

## Absolute Maximum Ratings <sup>4,5</sup>

Parameter	Absolute Maximum
Maximum Input Power 0.05 GHz 0.5-2.0 GHz	+27 dBm +34 dBm
$V_{CC}$	$-0.5V \leq V_{CC} \leq +7.0V$
$V_{EE}$	$-8.5V \leq V_{EE} \leq +0.5V$
$V_{CC} - V_{EE}$	$-0.5V \leq V_{CC} - V_{EE} \leq 14.5V$
$V_{in}^6$	$-0.5V \leq V_{in} \leq V_{CC} + 0.5V$
Operating Temperature	-55°C to +125°C
Storage Temperature	-65°C to +150°C

- Exceeding any one or combination of these limits may cause permanent damage to this device.
- M/A-COM does not recommend sustained operation near these survivability limits.
- Standard CMOS TTL interface, latch-up will occur if logic signal is applied prior to power supply.

## Handling Procedures

Please observe the following precautions to avoid damage:

## Static Sensitivity

Gallium Arsenide Integrated Circuits are sensitive to electrostatic discharge (ESD) and can be damaged by static electricity. Proper ESD control techniques should be used when handling these devices.

## Typical Performance Curves

### Reference Insertion Loss vs. Frequency @ Temperature

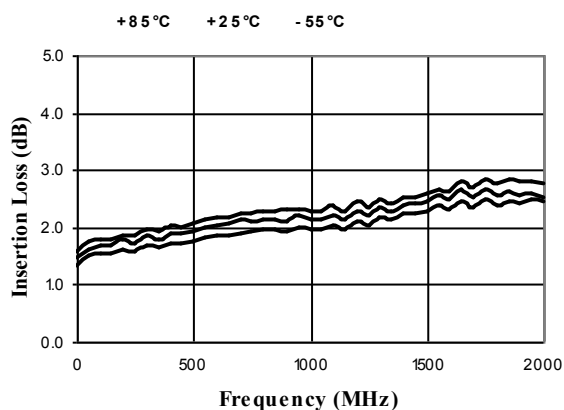

## Recommended PCB Configuration

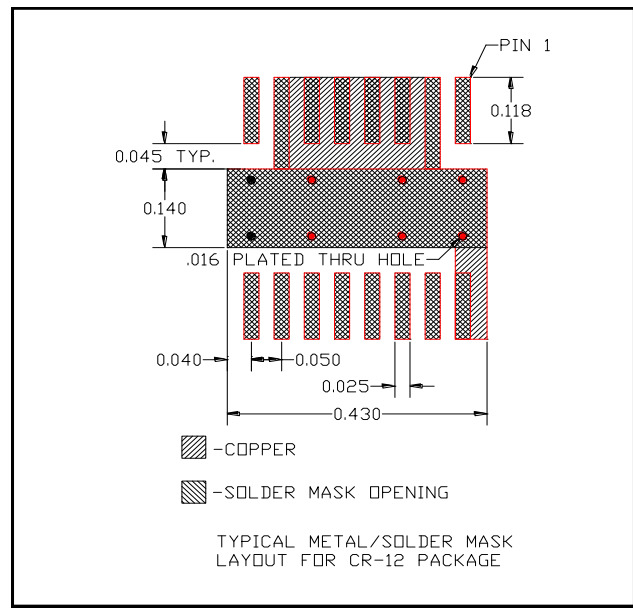

## Truth Table (Digital Attenuator)

Control Inputs					
C1	C2	C3	C4	C5	Attenuation
0	0	0	0	0	Reference
1	0	0	0	0	0.5 dB
0	1	0	0	0	1 dB
0	0	1	0	0	2 dB
0	0	0	1	0	4 dB
0	0	0	0	1	8 dB
1	1	1	1	1	15.5 dB

0 = TTL Low; 1 = TTL High

### Attenuation Accuracy vs. Frequency 0.5, 1, 2 dB Bits

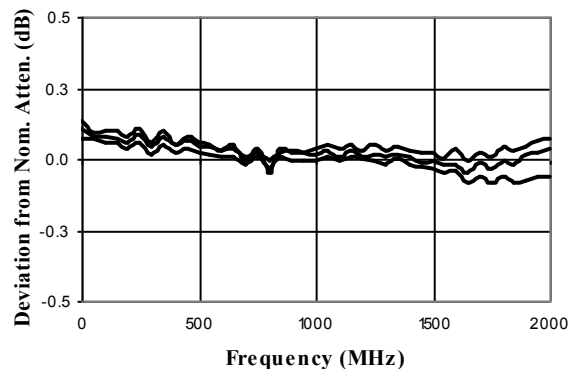

**Digital Attenuator**  
**15.5 dB, 5-Bit, TTL Driver, DC-2.0 GHz**

Rev. V7

## Typical Performance Curves

**Attenuation Accuracy vs. Frequency 4, 8 dB Bits and Full Attenuation**

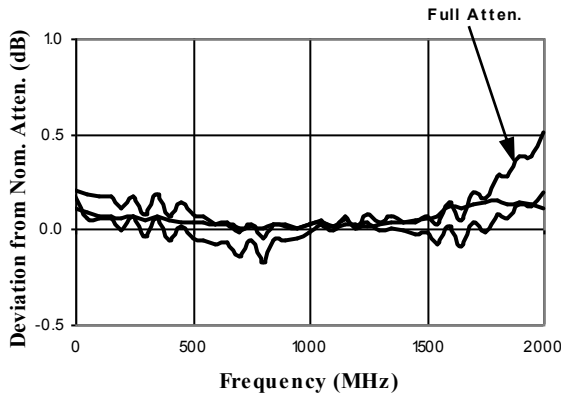

**VSWR vs. Frequency Reference Loss, 0.5, 1, 2 dB Bits**

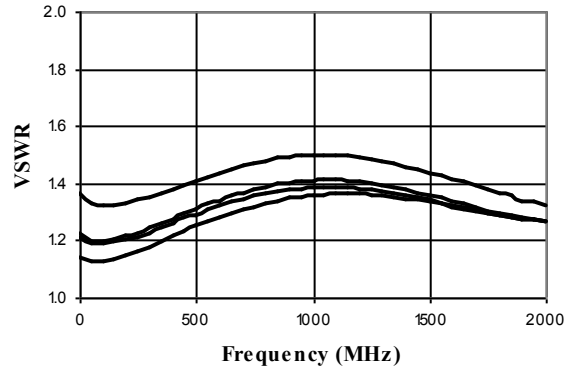

**VSWR vs. Frequency 4, 8 dB Bits and Full Attenuation**

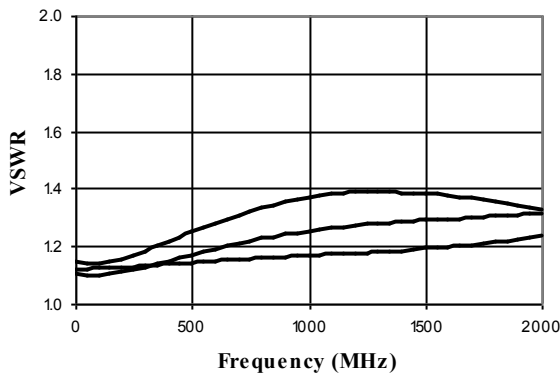

## Lead-Free, CR-12 Ceramic Package<sup>†</sup>

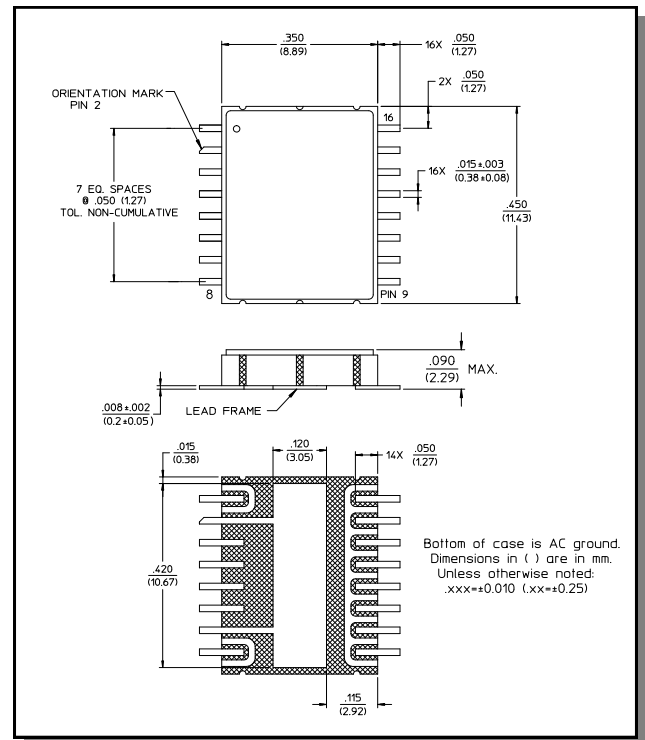

<sup>†</sup> Reference Application Note M538 for lead-free solder reflow recommendations.

M/A-COM Technology Solutions Inc. All rights reserved.

Information in this document is provided in connection with M/A-COM Technology Solutions Inc ("MACOM") products. These materials are provided by MACOM as a service to its customers and may be used for informational purposes only. Except as provided in MACOM's Terms and Conditions of Sale for such products or in any separate agreement related to this document, MACOM assumes no liability whatsoever. MACOM assumes no responsibility for errors or omissions in these materials. MACOM may make changes to specifications and product descriptions at any time, without notice. MACOM makes no commitment to update the information and shall have no responsibility whatsoever for conflicts or incompatibilities arising from future changes to its specifications and product descriptions. No license, express or implied, by estoppel or otherwise, to any intellectual property rights is granted by this document.

THESE MATERIALS ARE PROVIDED "AS IS" WITHOUT WARRANTY OF ANY KIND, EITHER EXPRESS OR IMPLIED, RELATING TO SALE AND/OR USE OF MACOM PRODUCTS INCLUDING LIABILITY OR WARRANTIES RELATING TO FITNESS FOR A PARTICULAR PURPOSE, CONSEQUENTIAL OR INCIDENTAL DAMAGES, MERCHANTABILITY, OR INFRINGEMENT OF ANY PATENT, COPYRIGHT OR OTHER INTELLECTUAL PROPERTY RIGHT. MACOM FURTHER DOES NOT WARRANT THE ACCURACY OR COMPLETENESS OF THE INFORMATION, TEXT, GRAPHICS OR OTHER ITEMS CONTAINED WITHIN THESE MATERIALS. MACOM SHALL NOT BE LIABLE FOR ANY SPECIAL, INDIRECT, INCIDENTAL, OR CONSEQUENTIAL DAMAGES, INCLUDING WITHOUT LIMITATION, LOST REVENUES OR LOST PROFITS, WHICH MAY RESULT FROM THE USE OF THESE MATERIALS.

MACOM products are not intended for use in medical, lifesaving or life sustaining applications. MACOM customers using or selling MACOM products for use in such applications do so at their own risk and agree to fully indemnify MACOM for any damages resulting from such improper use or sale.

5

---

M/A-COM Technology Solutions Inc. (MACOM) and its affiliates reserve the right to make changes to the product(s) or information contained herein without notice.  
Visit [www.macom.com](http://www.macom.com) for additional data sheets and product information.