

385-410nm VIOLET LED Emitter

LZP-00UB00



Key Features

- Ultra-high flux output 385-410nm surface mount ceramic VIOLET LED package with integrated glass lens
- 5nm wavelength bins
- Small high density foot print – 12.0mm x 12.0mm
- Exceptionally low Thermal Resistance (0.6°C/W)
- Electrically neutral thermal slug
- Autoclave complaint (JEDEC JESD22-A102-C)
- JEDEC Level 1 for Moisture Sensitivity Level
- Lead (Pb) free and RoHS compliant
- Copper core MCPCB option with emitter thermal slug directly soldered to the copper core

Typical Applications

- Curing
- Sterilization
- Medical
- Currency Verification
- Fluorescence Microscopy
- Inspection of dyes, rodent and animal contamination,
- Leak detection
- Forensics

Description

The LZP-series emitter is rated for 90W power handling in an ultra compact package. With a small 12.0mm x 12.0mm footprint, this package provides exceptional radiant flux density. The patented design has unparalleled thermal and optical performance. The high quality materials used in the package are chosen to optimize Radiant Flux and minimize stresses which results in monumental reliability and radiant flux maintenance. The robust product design thrives in outdoor applications with high ambient temperatures and high humidity.

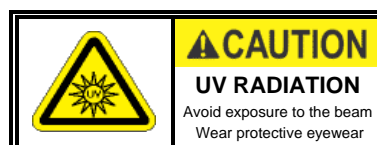

Part number options

Base part number

Part number	Description
LZP-00UB00-xxxx	LZP emitter
LZP-D0UB00-xxxx	LZP emitter on 5 channel 4x6+1 Star MCPCB

Bin kit option codes

Single wavelength bin (5nm range)

Kit number suffix	Min flux Bin	Color Bin Range	Description
00U4	C2	U4	C2 minimum flux; wavelength U4 bin only
00U5	C2	U5	C2 minimum flux; wavelength U5 bin only
00U6	C2	U6	C2 minimum flux; wavelength U6 bin only
00U7	Z	U7	Z minimum flux; wavelength U7 bin only
00U8	Z	U8	Z minimum flux; wavelength U8 bin only

Radiant Flux Bins

Table 1:

Bin Code	Minimum Radiant Flux (Φ) @ $I_F = 700\text{mA}$ ^[1,2] (W)	Maximum Radiant Flux (Φ) @ $I_F = 700\text{mA}$ ^[1,2] (W)
Z	15.0	20.0
C2	20.0	25.0
D2	25.0	31.2

Notes for Table 1:

1. Radiant flux performance is measured at specified current, 10ms pulse width, $T_C = 25^\circ\text{C}$. LED Engin maintains a tolerance of $\pm 10\%$ on flux measurements.

Peak Wavelength Bins

Table 2:

Bin Code	Minimum Peak Wavelength (λ_P) @ $I_F = 700\text{mA}$ ^[1] (nm)	Maximum Peak Wavelength (λ_P) @ $I_F = 700\text{mA}$ ^[1] (nm)
U4	385	390
U5	390	395
U6	395	400
U7	400	405
U8	405	410

Notes for Table 2:

1. Peak wavelength is measured at specified current, 10ms pulse width, $T_C = 25^\circ\text{C}$. LED Engin maintains a tolerance of $\pm 2.0\text{nm}$ on peak wavelength measurements.

Forward Voltage Bins

Table 3:

Bin Code	Minimum Forward Voltage (V_F/Ch) @ $I_F = 700\text{mA}$ ^[1,2] (V)	Maximum Forward Voltage (V_F/Ch) @ $I_F = 700\text{mA}$ ^[1,2] (V)
0	20.64	23.52

Notes for Table 3:

1. LED Engin maintains a tolerance of $\pm 0.24\text{V}$ for forward voltage measurements.
2. Forward Voltage is binned with 6 LED dies connected in series at specified current, 10ms pulse width, $T_C = 25^\circ\text{C}$. The LED is configured with 4 Channels of 6 dies in series each.

Absolute Maximum Ratings

Table 4:

Parameter	Symbol	Value	Unit
DC Forward Current ^[1]	I_F	1000 /Channel	mA
Peak Pulsed Forward Current ^[2]	I_{FP}	1000 /Channel	mA
Reverse Voltage	V_R	See Note 3	V
Storage Temperature	T_{stg}	-40 ~ +150	°C
Junction Temperature	T_J	130	°C
Soldering Temperature ^[4]	T_{sol}	260	°C

Notes for Table 4:

- Maximum DC forward current (per die) is determined by the overall thermal resistance and ambient temperature. Follow the curves in Figure 10 for current derating.
- Pulse forward current conditions: Pulse Width \leq 10msec and Duty Cycle \leq 10%.
- LEDs are not designed to be reverse biased.
- Solder conditions per JEDEC 020D. See Reflow Soldering Profile Figure 3.
- LED Engin recommends taking reasonable precautions towards possible ESD damages and handling the LZP-00UA00in an electrostatic protected area (EPA). An EPA may be adequately protected by ESD controls as outlined in ANSI/ESD S6.1.

Optical Characteristics @ $T_C = 25^\circ\text{C}$

Table 5:

Parameter	Symbol	Typical			Unit
		385-390nm	390-400nm	400-410nm	
Radiant Flux (@ $I_F = 700\text{mA}$)	Φ	24.5	24.5	22.5	W
Radiant Flux (@ $I_F = 1000\text{mA}$)	Φ	34.0	34.0	31.0	W
Peak Wavelength ^[1]	λ_p	385	395	405	nm
Viewing Angle ^[2]	$2\theta_{1/2}$		130		Degrees
Total Included Angle ^[3]	$\theta_{0.9v}$		140		Degrees

Notes for Table 5:

- When operating the VIOLET LED, observe IEC 60825-1 class 3B rating. Avoid exposure to the beam.
- Viewing Angle is the off axis angle from emitter centerline where the Radiant intensity is $\frac{1}{2}$ of the peak value.
- Total Included Angle is the total angle that includes 90% of the total Radiant flux.

Electrical Characteristics @ $T_C = 25^\circ\text{C}$

Table 6:

Parameter	Symbol	Typical	Unit
Forward Voltage (@ $I_F = 700\text{mA}$) ^[1]	V_F	22.0 /Channel	V
Temperature Coefficient of Forward Voltage ^[1]	$\Delta V_F / \Delta T_J$	-13.2	mV/°C
Thermal Resistance (Junction to Case)	$R\theta_{J-C}$	0.6	°C/W

Notes for Table 6:

- Forward Voltage is measured for a single string of 6 dies connected in series. The LED is configured with 4 Channels of 6 dies in series each.

IPC/JEDEC Moisture Sensitivity Level

Table 7 - IPC/JEDEC J-STD-20D.1 MSL Classification:

Level	Soak Requirements					
	Floor Life		Standard		Accelerated	
	Time	Conditions	Time (hrs)	Conditions	Time (hrs)	Conditions
1	Unlimited	≤ 30°C/ 85% RH	168 +5/-0	85°C/ 85% RH	n/a	n/a

Notes for Table 7:

1. The standard soak time includes a default value of 24 hours for semiconductor manufacturer's exposure time (MET) between bake and bag and includes the maximum time allowed out of the bag at the distributor's facility.

Average Radiant Flux Maintenance Projections

Lumen maintenance generally describes the ability of an emitter to retain its output over time. The useful lifetime for power LEDs is also defined as Radiant Flux Maintenance, with the percentage of the original light output remaining at a defined time period.

Based on long-term WHTOL testing, LED Engin projects that the LZ Series will deliver, on average, 70% Radiant Flux Maintenance (RP70%) at 20,000 hours of operation at a forward current of 700 mA per die. This projection is based on constant current operation with junction temperature maintained at or below 80°C.

Recommended Solder Mask Layout (mm)

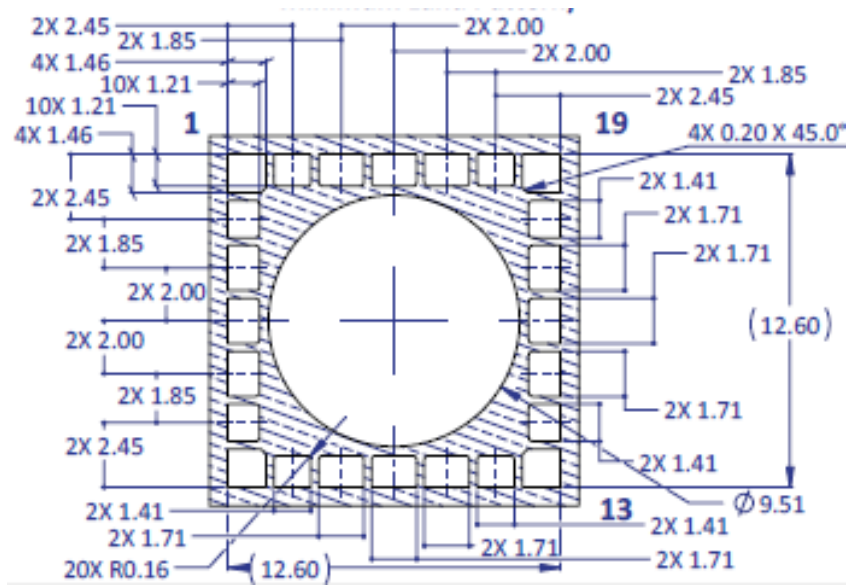

Figure 2b: Recommended solder mask opening for anode, cathode, and thermal pad

Note for Figure 2b:

1. Unless otherwise noted, the tolerance = ± 0.20 mm.

Recommended 8 mil Stencil Apertures Layout (mm)

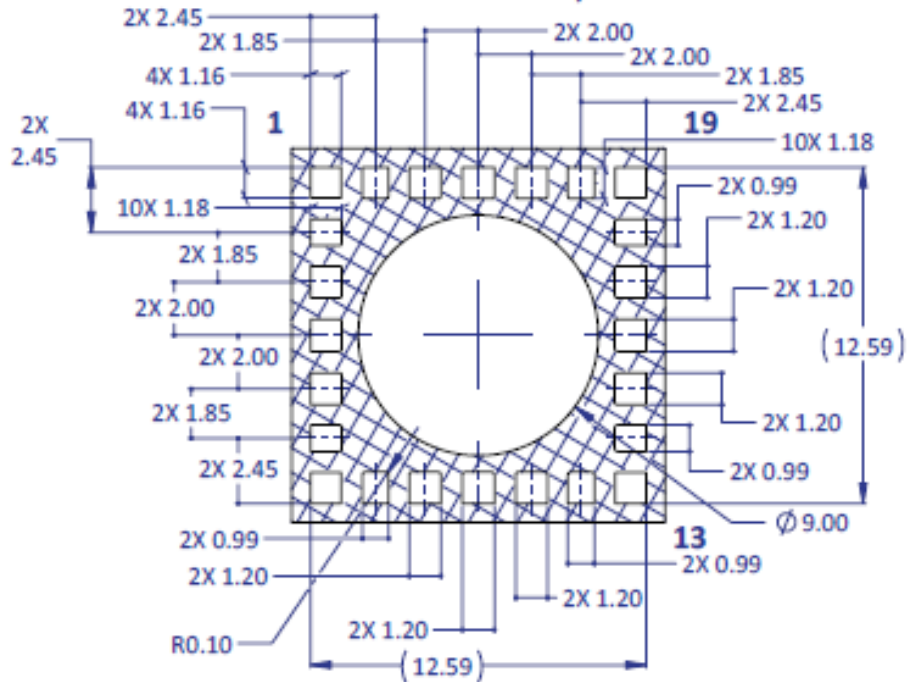

Figure 2c: Recommended 8mil stencil apertures for anode, cathode, and thermal pad

Note for Figure 2c:

1. Unless otherwise noted, the tolerance = ± 0.20 mm.

Reflow Soldering Profile

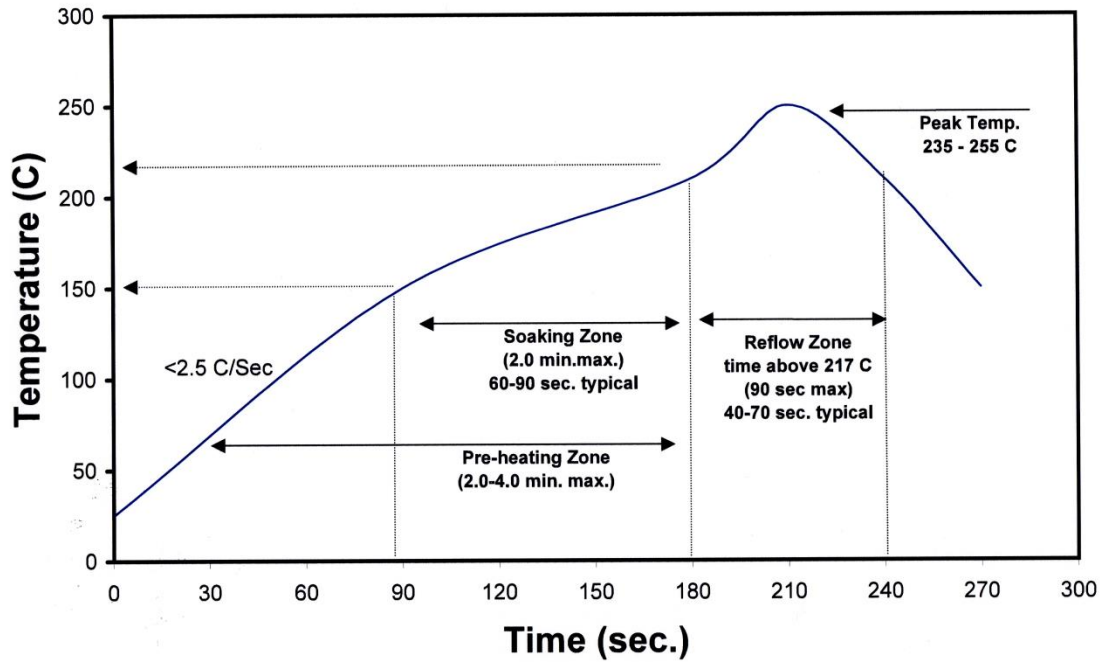

Figure 3: Reflow soldering profile for lead free soldering.

Typical Radiation Pattern

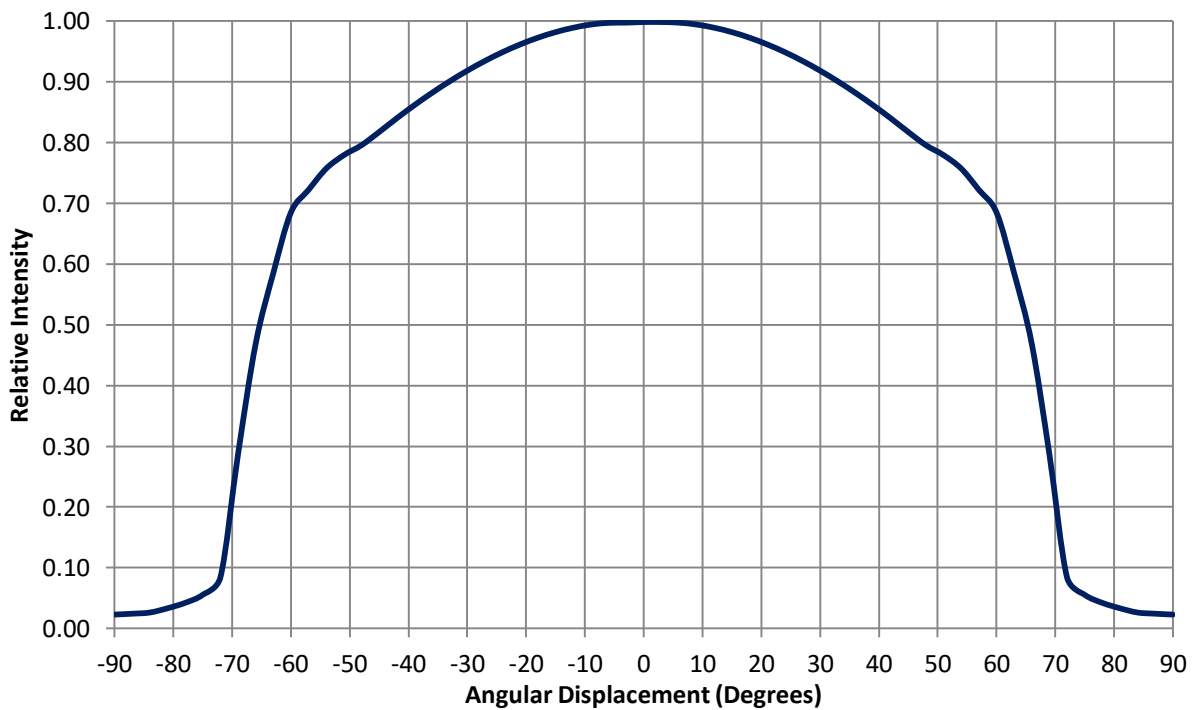

Figure 4: Typical representative spatial radiation pattern.

Typical Relative Spectral Power Distribution

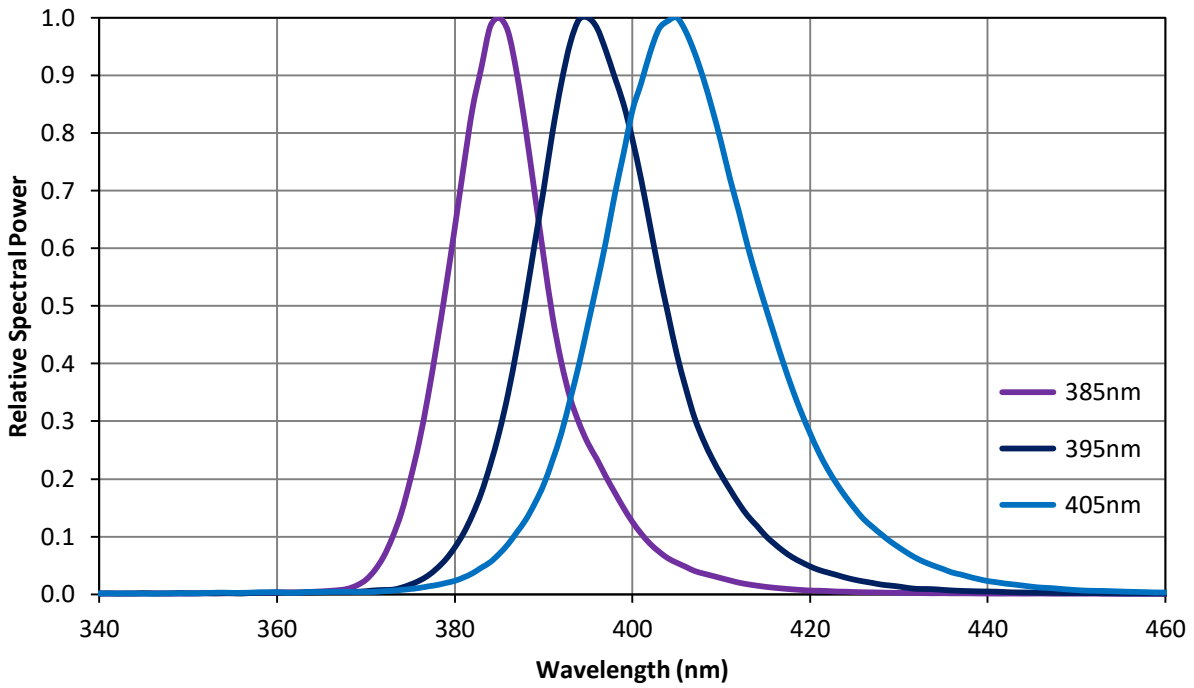

Figure 5: Relative spectral power vs. wavelength @ T_c = 25°C.

Typical Forward Current Characteristics

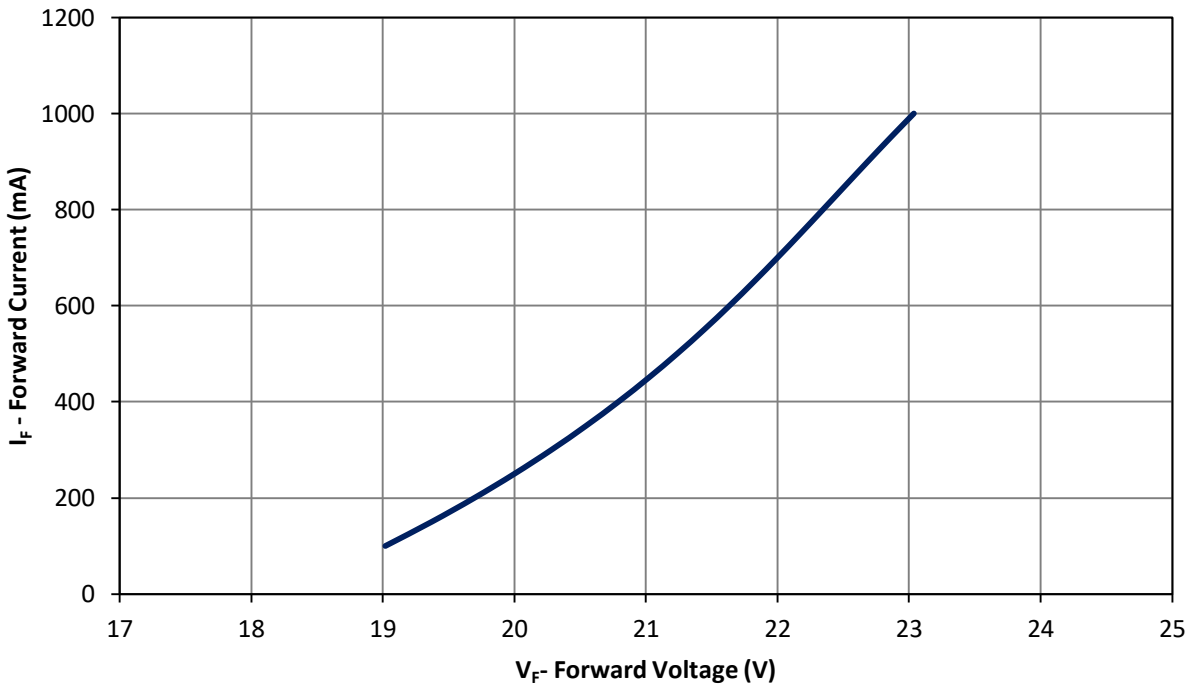

Figure 6: Typical forward current vs. forward voltage @ T_c = 25°C.

Notes:

1. Forward Voltage curve is per channel with 6 LED dies connected in series. The LZP-00UB00 is configured with 4 Channels of 6 dies in series each.

Typical Normalized Radiant Flux over Current

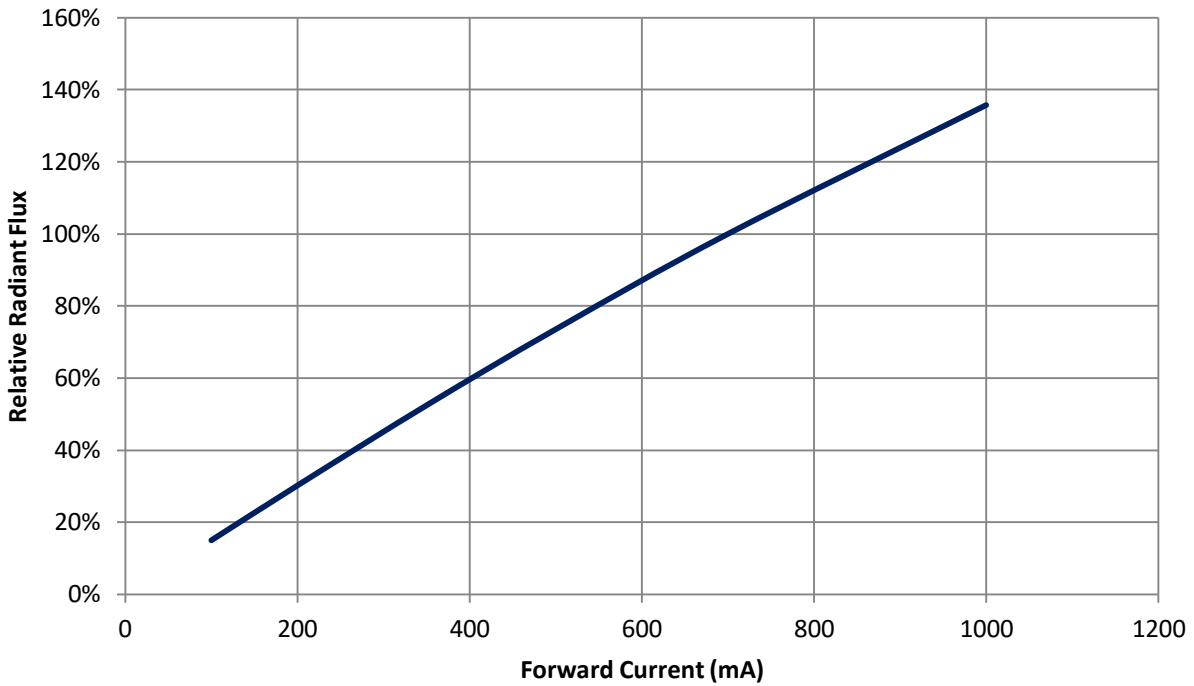

Figure 7: Typical normalized radiant flux vs. forward current @ T_c = 25°C.

Typical Normalized Radiant Flux over Temperature

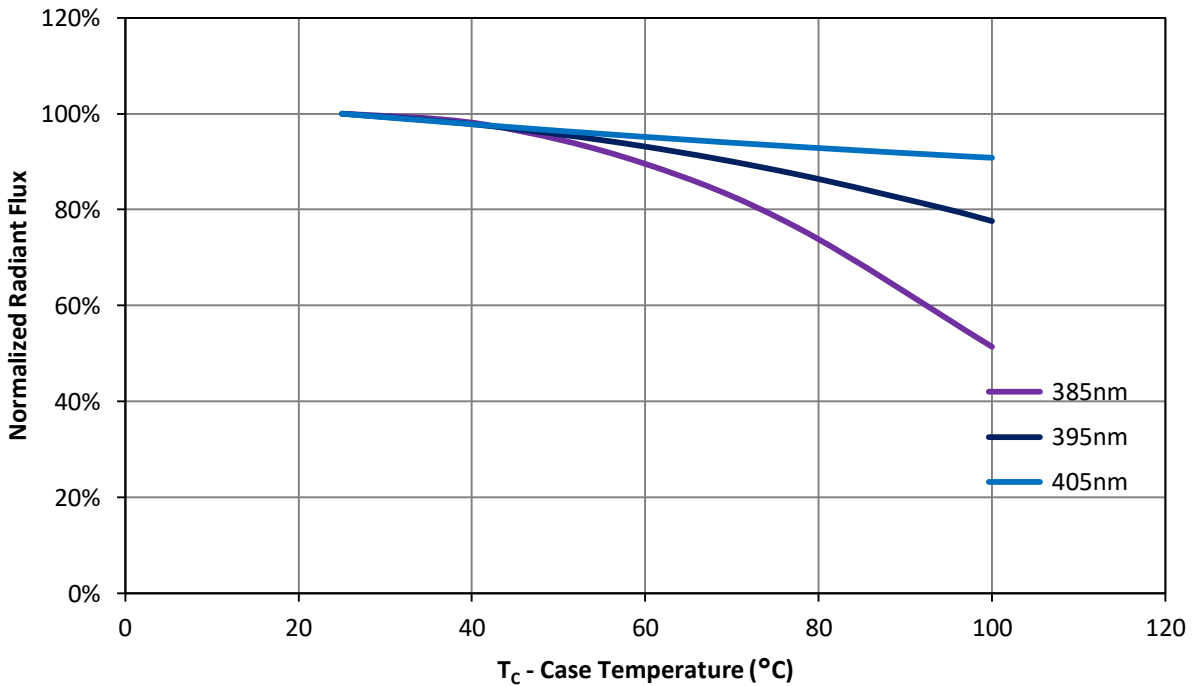

Figure 8: Typical normalized radiant flux vs. case temperature @700mA

Typical Peak Wavelength Shift over Current

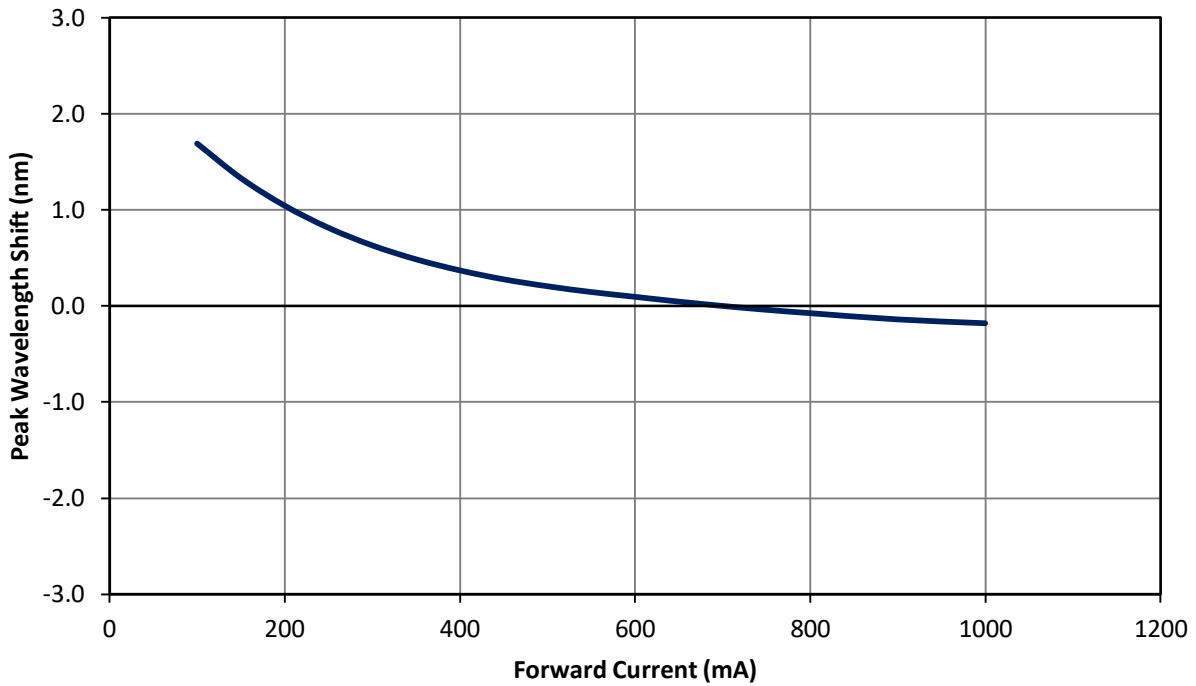

Figure 9: Typical peak wavelength shift vs. forward current @ Tc = 25°C

Typical Peak Wavelength Shift over Temperature

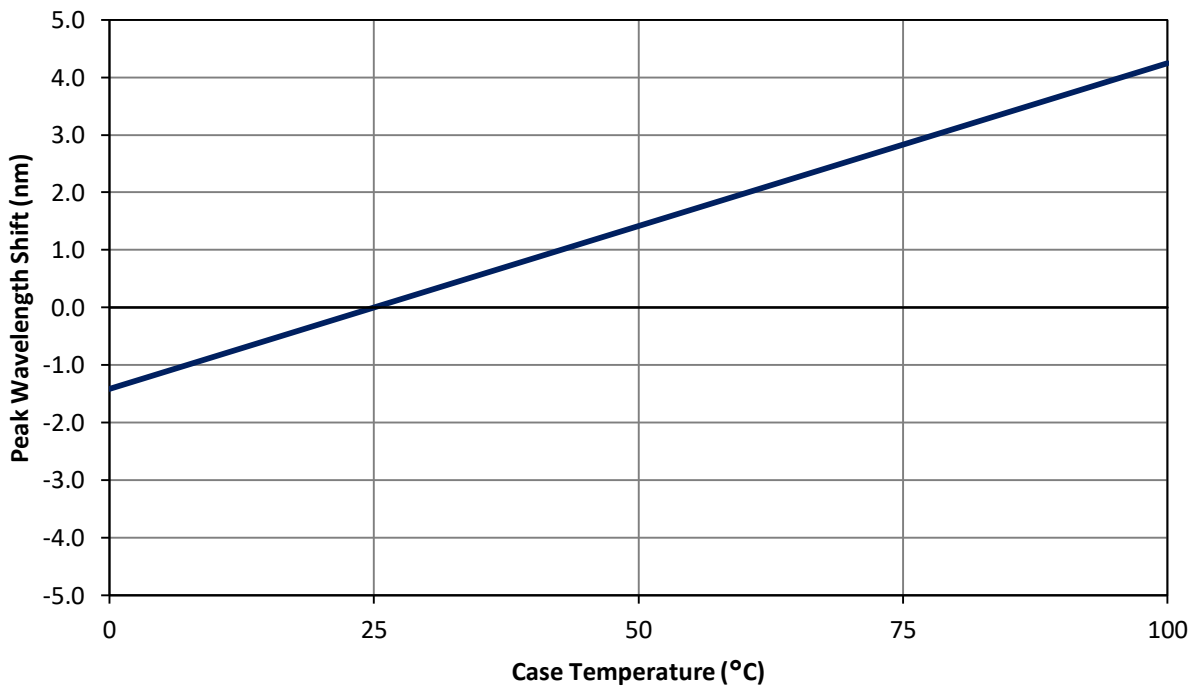

Figure 10: Typical peak wavelength shift vs. case temperature @700mA

Current De-rating

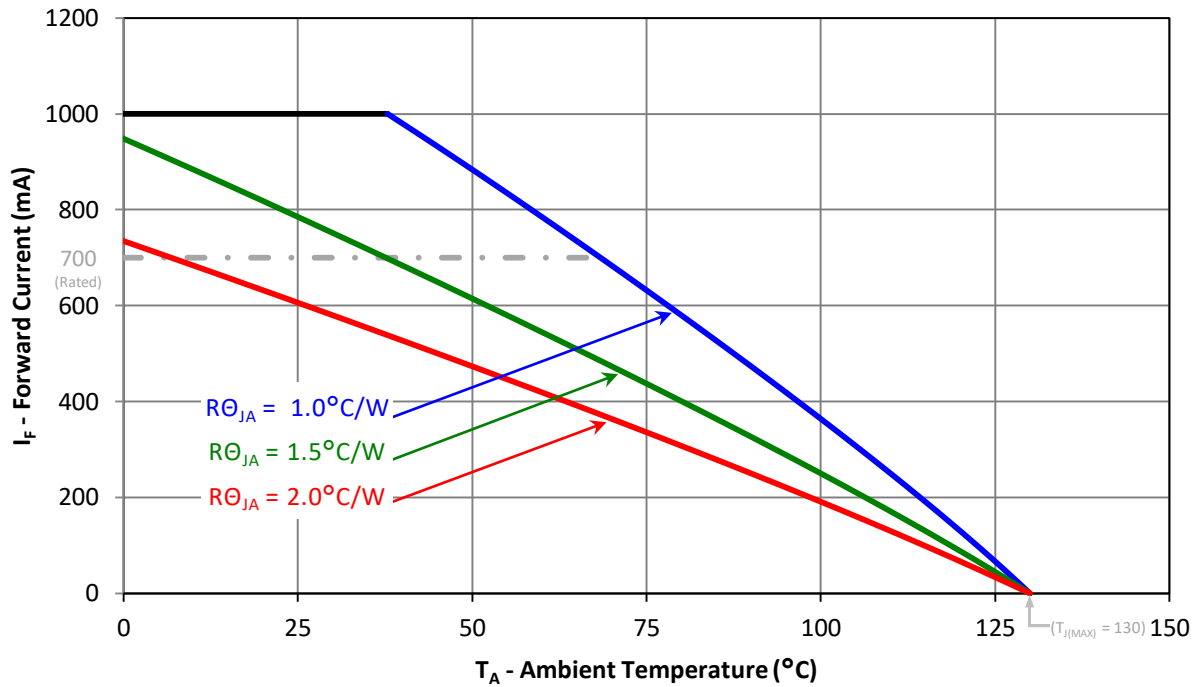

Figure 10: Maximum forward current vs. ambient temperature based on $T_{j(\text{MAX})} = 130^\circ\text{C}$.

Notes:

1. Maximum current assumes that all LED dies are operating at rated current.
2. $R\theta_{j-c}$ [Junction to Case Thermal Resistance] for the LZP-series is typically 0.6°C/W .
3. $R\theta_{j-a}$ [Junction to Ambient Thermal Resistance] = $R\theta_{j-c}$ + $R\theta_{c-a}$ [Case to Ambient Thermal Resistance].

LZP MCPCB Family

Part number	Type of MCPCB	Diameter (mm)	Emitter + MCPCB Thermal Resistance (°C /W)	Typical V _f (V)	Typical I _f (mA)
LZP-Dxxxxx	5-channel (4x6+1 strings)	28.3	0.6 + 0.1 = 0.7	22.0	4 x 700

LZP-Dxxxxx

5-channel, Standard Star MCPCB (4x6+1) Mechanical Dimensions (mm)

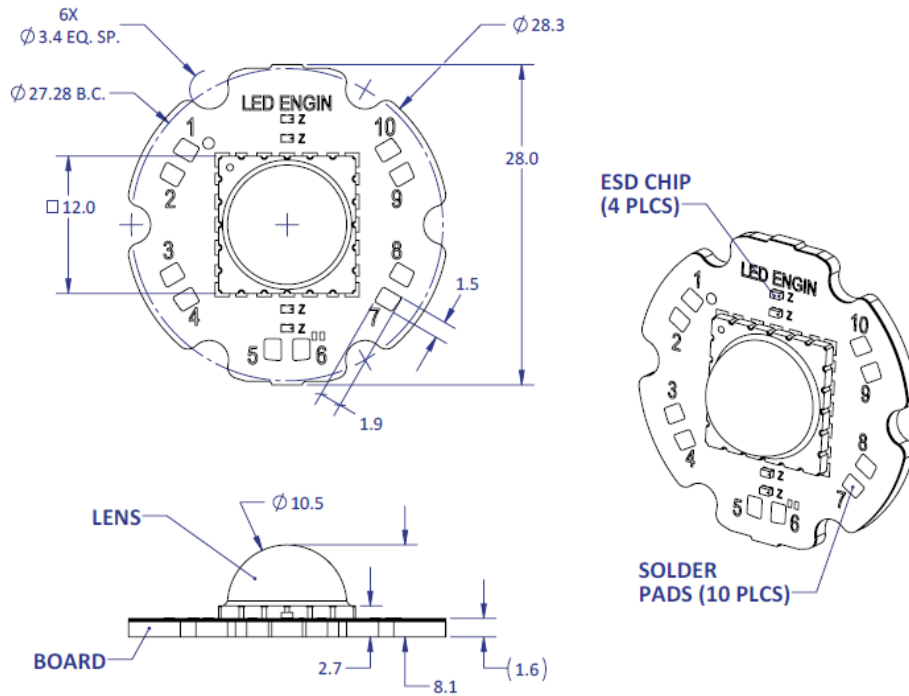

Notes:

1. Unless otherwise noted, the tolerance = ± 0.20 mm.
2. Slots in MCPCB are for M3 or #4 mounting screws.
3. LED Engin recommends using plastic washers to electrically insulate screws from solder pads and electrical traces.
4. LED Engin recommends using thermal interface material when attaching the MCPCB to a heat sink.
5. LED Engin uses a copper core MCPCB with pedestal design, allowing direct solder connect between the MCPCB copper core and the emitter thermal slug. The thermal resistance of this copper core MCPCB is: $R_{\theta C-B} 0.1^{\circ}\text{C/W}$

Components used

MCPCB: SuperMCPCB
ESD chips: BZT52C36LP

(Bridge Semiconductor, copper core with pedestal design)
(NXP, for 6 LED dies in series)

Pad layout			
Ch.	MCPCB Pad	String/die	Function
1	1	1/EDCBAF	Cathode -
	10		Anode +
2	2	2/JIHGLK	Cathode -
	9		Anode +
3	3	3/ONSQRQP	Cathode -
	8		Anode +
4	4	4/TYXWVU	Cathode -
	7		Anode +
5	5	5/M	N/A
	6		N/A

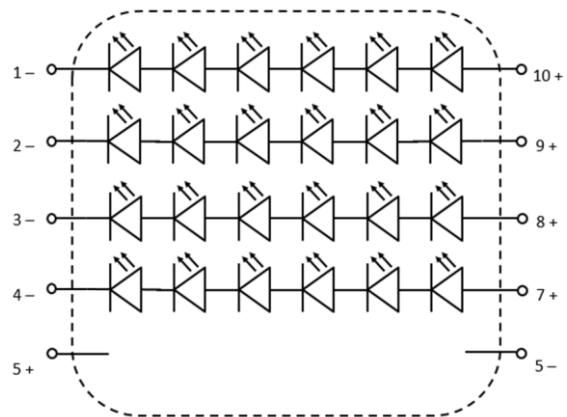

Application Guidelines

MCPCB Assembly Recommendations

A good thermal design requires an efficient heat transfer from the MCPCB to the heat sink. In order to minimize air gaps in between the MCPCB and the heat sink, it is common practice to use thermal interface materials such as thermal pastes, thermal pads, phase change materials and thermal epoxies. Each material has its pros and cons depending on the design. Thermal interface materials are most efficient when the mating surfaces of the MCPCB and the heat sink are flat and smooth. Rough and uneven surfaces may cause gaps with higher thermal resistances, increasing the overall thermal resistance of this interface. It is critical that the thermal resistance of the interface is low, allowing for an efficient heat transfer to the heat sink and keeping MCPCB temperatures low.

When optimizing the thermal performance, attention must also be paid to the amount of stress that is applied on the MCPCB. Too much stress can cause the ceramic emitter to crack. To relax some of the stress, it is advisable to use plastic washers between the screw head and the MCPCB and to follow the torque range listed below. For applications where the heat sink temperature can be above 50°C, it is recommended to use high temperature and rigid plastic washers, such as polycarbonate or glass-filled nylon.

LED Engin recommends the use of the following thermal interface materials:

1. Bergquist's Gap Pad 5000S35, 0.020in thick
 - Part Number: Gap Pad® 5000S35 0.020in/0.508mm
 - Thickness: 0.020in/0.508mm
 - Thermal conductivity: 5 W/m-K
 - Continuous use max temperature: 200°C
 - Using M3 Screw (or #4 screw), with polycarbonate or glass-filled nylon washer (#4) the recommended torque range is: 20 to 25 oz-in (1.25 to 1.56 lbf-in or 0.14 to 0.18 N-m)

2. 3M's Acrylic Interface Pad 5590H
 - Part number: 5590H @ 0.5mm
 - Thickness: 0.020in/0.508mm
 - Thermal conductivity: 3 W/m-K
 - Continuous use max temperature: 100°C
 - Using M3 Screw (or #4 screw), with polycarbonate or glass-filled nylon washer (#4) the recommended torque range is: 20 to 25 oz-in (1.25 to 1.56 lbf-in or 0.14 to 0.18 N-m)

Mechanical Mounting Considerations

The mounting of MCPCB assembly is a critical process step. Excessive mechanical stress build up in the MCPCB can cause the MCPCB to warp which can lead to emitter substrate cracking and subsequent cracking of the LED dies

LED Engin recommends the following steps to avoid mechanical stress build up in the MCPCB:

- Inspect MCPCB and heat sink for flatness and smoothness.
- Select appropriate torque for mounting screws. Screw torque depends on the MCPCB mounting method (thermal interface materials, screws, and washer).
- Always use three M3 or #4-40 screws with #4 washers.
- When fastening the three screws, it is recommended to tighten the screws in multiple small steps. This method avoids building stress by tilting the MCPCB when one screw is tightened in a single step.
- Always use plastic washers in combinations with the three screws. This avoids high point contact stress on the screw head to MCPCB interface, in case the screw is not seated perpendicular.
- In designs with non-tapped holes using self-tapping screws, it is common practice to follow a method of three turns tapping a hole clockwise, followed by half a turn anti-clockwise, until the appropriate torque is reached.

Wire Soldering

- To ease soldering wire to MCPCB process, it is advised to preheat the MCPCB on a hot plate of 125-150°C. Subsequently, apply the solder and additional heat from the solder iron will initiate a good solder reflow. It is recommended to use a solder iron of more than 60W.
- It is advised to use lead-free, no-clean solder. For example: SN-96.5 AG-3.0 CU 0.5 #58/275 from Kester (pn: 24-7068-7601)

About LED Engin

LED Engin, an OSRAM business based in California's Silicon Valley, develops, manufactures, and sells advanced LED emitters, optics and light engines to create uncompromised lighting experiences for a wide range of entertainment, architectural, general lighting and specialty applications. LuxiGen™ multi-die emitter and secondary lens combinations reliably deliver industry-leading flux density, upwards of 5000 quality lumens to a target, in a wide spectrum of colors including whites, tunable whites, multi-color and UV LEDs in a unique patented compact ceramic package. Our LuxiTune™ series of tunable white lighting modules leverage our LuxiGen emitters and lenses to deliver quality, control, freedom and high density tunable white light solutions for a broad range of new recessed and downlighting applications. The small size, yet remarkably powerful beam output and superior in-source color mixing, allows for a previously unobtainable freedom of design wherever high-flux density, directional light is required. LED Engin is committed to providing products that conserve natural resources and reduce greenhouse emissions; and reserves the right to make changes to improve performance without notice.

For more information, please contact sales@ledengin.com or +1 408 922-7200.