

# LMV1012

*LMV1012 Analog Series: Pre-Amplified IC's for High Gain 2-Wire Microphones*



Literature Number: SNAS194G

# LMV1012 Analog Series: Pre-Amplified IC's for High Gain 2-Wire Microphones

## General Description

The LMV1012 is an audio amplifier series for small form factor electret microphones. This 2-wire portfolio is designed to replace the JFET amplifier currently being used. The LMV1012 series is ideally suited for applications requiring high signal integrity in the presence of ambient or RF noise, such as in cellular communications. The LMV1012 audio amplifiers are guaranteed to operate over a 2.2V to 5.0V supply voltage range with fixed gains of 7.8 dB, 15.6 dB, 20.9 dB, and 23.8 dB. The devices offer excellent THD, gain accuracy and temperature stability as compared to a JFET microphone.

The LMV1012 series enables a two-pin electret microphone solution, which provides direct pin-to-pin compatibility with the existing JFET market.

The devices are offered in extremely thin space saving 4-bump micro SMD packages. The LMV1012XP is designed for 1.0 mm canisters and thicker ECM canisters. These extremely miniature packages are designed for electret condenser microphones (ECM) form factor.

## Features

(Typical LMV1012-15, 2.2V supply,  $R_L = 2.2\text{ k}\Omega$ ,  $C = 2.2\text{ }\mu\text{F}$ ,  $V_{IN} = 18\text{ mV}_{PP}$ , unless otherwise specified)

■ Supply voltage	2V - 5V
■ Supply current	<180 $\mu\text{A}$
■ Signal to noise ratio (A-weighted)	60 dB
■ Output voltage noise (A-weighted)	-89 dBV
■ Total harmonic distortion	0.09%
■ Voltage gain	
— LMV1012-07	7.8 dB
— LMV1012-15	15.6 dB
— LMV1012-20	20.9 dB
— LMV1012-25	23.8 dB
■ Temperature range	-40°C to 85°C
■ Offered in 4-bump micro SMD packages	

## Applications

- Cellular phones
- Headsets
- Mobile communications
- Automotive accessories
- PDAs
- Accessory microphone products

## Schematic Diagram

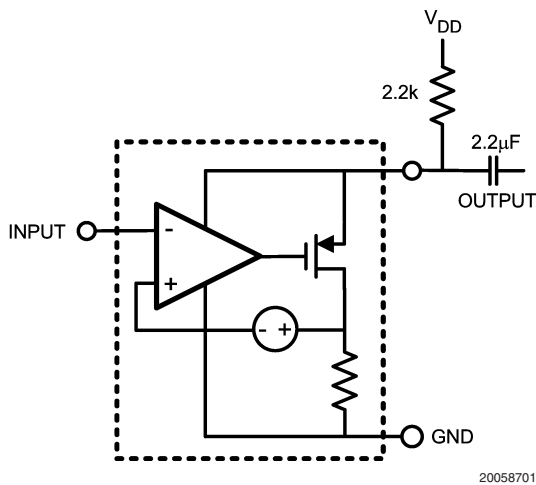

## Built-In Gain Electret Microphone

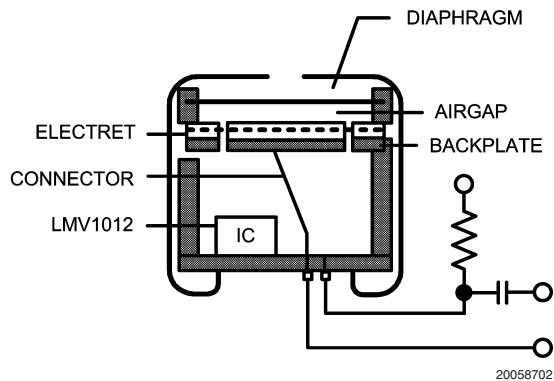

### Absolute Maximum Ratings (Note 1)

If Military/Aerospace specified devices are required, please contact the National Semiconductor Sales Office/Distributors for availability and specifications.

ESD Tolerance (Note 2)	
Human Body Model	2500V
Machine Model	250V
Supply Voltage	
$V_{DD} - GND$	5.5V

Storage Temperature Range	-65°C to 150°C
Junction Temperature (Note 6)	150°C max
Mounting Temperature	
Infrared or Convection (20 sec.)	235°C

### Operating Ratings (Note 1)

Supply Voltage	2V to 5V
Temperature Range	-40°C to 85°C

### 2.2V Electrical Characteristics (Note 3)

Unless otherwise specified, all limits guaranteed for  $T_J = 25^\circ\text{C}$ ,  $V_{DD} = 2.2\text{V}$ ,  $V_{IN} = 18\text{ mV}$ ,  $R_L = 2.2\text{ k}\Omega$  and  $C = 2.2\text{ }\mu\text{F}$ . **Boldface** limits apply at the temperature extremes.

Symbol	Parameter	Conditions	Min (Note 4)	Typ (Note 5)	Max (Note 4)	Units	
$I_{DD}$	Supply Current	$V_{IN} = GND$	LMV1012-07		139	250 <b>300</b>	$\mu\text{A}$
			LMV1012-15		180	300 <b>325</b>	
			LMV1012-20		160	250 <b>300</b>	
			LMV1012-25		141	250 <b>300</b>	
SNR	Signal to Noise Ratio	$f = 1\text{ kHz}$ , $V_{IN} = 18\text{ mV}$ , A-Weighted	LMV1012-07		59		dB
			LMV1012-15		60		
			LMV1012-20		61		
			LMV1012-25		61		
$V_{IN}$	Max Input Signal	$f = 1\text{ kHz}$ and THD+N < 1%	LMV1012-07		170		$\text{mV}_{PP}$
			LMV1012-15		100		
			LMV1012-20		50		
			LMV1012-25		28		
$V_{OUT}$	Output Voltage	$V_{IN} = GND$	LMV1012-07	1.65 <b>1.54</b>	1.90	2.03 <b>2.09</b>	V
			LMV1012-15	1.54 <b>1.48</b>	1.81	1.94 <b>2.00</b>	
			LMV1012-20	1.65 <b>1.55</b>	1.85	2.03 <b>2.13</b>	
			LMV1012-25	1.65 <b>1.49</b>	1.90	2.02 <b>2.18</b>	
$f_{LOW}$	Lower -3dB Roll Off Frequency	$R_{SOURCE} = 50\Omega$		65		Hz	
$f_{HIGH}$	Upper -3dB Roll Off Frequency	$R_{SOURCE} = 50\Omega$		95		kHz	
$e_n$	Output Noise	A-Weighted	LMV1012-07		-96		dBV
			LMV1012-15		-89		
			LMV1012-20		-84		
			LMV1012-25		-82		
THD	Total Harmonic Distortion	$f = 1\text{ kHz}$ , $V_{IN} = 18\text{ mV}$	LMV1012-07		0.10		%
			LMV1012-15		0.09		
			LMV1012-20		0.12		
			LMV1012-25		0.15		
$C_{IN}$	Input Capacitance			2		pF	
$Z_{IN}$	Input Impedance			>1000		G $\Omega$	

## 2.2V Electrical Characteristics (Note 3) (Continued)

Unless otherwise specified, all limits guaranteed for  $T_J = 25^\circ\text{C}$ ,  $V_{DD} = 2.2\text{V}$ ,  $V_{IN} = 18\text{ mV}$ ,  $R_L = 2.2\text{ k}\Omega$  and  $C = 2.2\text{ }\mu\text{F}$ .

**Boldface** limits apply at the temperature extremes.

Symbol	Parameter	Conditions	Min (Note 4)	Typ (Note 5)	Max (Note 4)	Units	
$A_V$	Gain	$f = 1\text{ kHz}$ , $R_{SOURCE} = 50\Omega$	LMV1012-07	6.4 <b>5.5</b>	7.8	9.5 <b>10.0</b>	dB
			LMV1012-15	14.0 <b>13.1</b>	15.6	16.9 <b>17.5</b>	
			LMV1012-20	19.5 <b>17.4</b>	20.9	22.0 <b>23.3</b>	
			LMV1012-25	22.5 <b>21.4</b>	23.8	25.0 <b>25.7</b>	

## 5V Electrical Characteristics (Note 3)

Unless otherwise specified, all limits guaranteed for  $T_J = 25^\circ\text{C}$ ,  $V_{DD} = 5\text{V}$ ,  $V_{IN} = 18\text{ mV}$ ,  $R_L = 2.2\text{ k}\Omega$  and  $C = 2.2\text{ }\mu\text{F}$ .

**Boldface** limits apply at the temperature extremes.

Symbol	Parameter	Conditions	Min (Note 4)	Typ (Note 5)	Max (Note 4)	Units	
$I_{DD}$	Supply Current	$V_{IN} = \text{GND}$	LMV1012-07		158	250 <b>300</b>	$\mu\text{A}$
			LMV1012-15		200	300 <b>325</b>	
			LMV1012-20		188	260 <b>310</b>	
			LMV1012-25		160	250 <b>300</b>	
SNR	Signal to Noise Ratio	$f = 1\text{ kHz}$ , $V_{IN} = 18\text{ mV}$ , A-Weighted	LMV1012-07		59		dB
			LMV1012-15		60		
			LMV1012-20		61		
			LMV1012-25		61		
$V_{IN}$	Max Input Signal	$f = 1\text{ kHz}$ and THD+N < 1%	LMV1012-07		170		$\text{mV}_{PP}$
			LMV1012-15		100		
			LMV1012-20		55		
			LMV1012-25		28		
$V_{OUT}$	Output Voltage	$V_{IN} = \text{GND}$	LMV1012-07	4.45 <b>4.38</b>	4.65	4.80 <b>4.85</b>	V
			LMV1012-15	4.34 <b>4.28</b>	4.56	4.74 <b>4.80</b>	
			LMV1012-20	4.40 <b>4.30</b>	4.58	4.75 <b>4.85</b>	
			LMV1012-25	4.45 <b>4.39</b>	4.65	4.83 <b>4.86</b>	
$f_{LOW}$	Lower -3dB Roll Off Frequency	$R_{SOURCE} = 50\Omega$		67		Hz	
$f_{HIGH}$	Upper -3dB Roll Off Frequency	$R_{SOURCE} = 50\Omega$		150		kHz	
$e_n$	Output Noise	A-Weighted	LMV1012-07		-96		dBV
			LMV1012-15		-89		
			LMV1012-20		-84		
			LMV1012-25		-82		
THD	Total Harmonic Distortion	$f = 1\text{ kHz}$ , $V_{IN} = 18\text{ mV}$	LMV1012-07		0.12		%
			LMV1012-15		0.13		
			LMV1012-20		0.18		
			LMV1012-25		0.21		

**5V Electrical Characteristics** (Note 3) (Continued)

Unless otherwise specified, all limits guaranteed for  $T_J = 25^\circ\text{C}$ ,  $V_{DD} = 5\text{V}$ ,  $V_{IN} = 18\text{ mV}$ ,  $R_L = 2.2\text{ k}\Omega$  and  $C = 2.2\text{ }\mu\text{F}$ .

**Boldface** limits apply at the temperature extremes.

Symbol	Parameter	Conditions	Min (Note 4)	Typ (Note 5)	Max (Note 4)	Units	
$C_{IN}$	Input Capacitance			2		pF	
$Z_{IN}$	Input Impedance			>1000		G $\Omega$	
$A_V$	Gain	$f = 1\text{ kHz}$ , $R_{SOURCE} = 50\Omega$	LMV1012-07	6.4 <b>5.5</b>	8.1	9.5 <b>10.7</b>	dB
			LMV1012-15	14.0 <b>13.1</b>	15.6	16.9 <b>17.5</b>	
			LMV1012-20	19.2 <b>17.0</b>	21.1	22.3 <b>23.5</b>	
			LMV1012-25	22.5 <b>21.2</b>	23.9	25.0 <b>25.8</b>	

**Note 1:** Absolute Maximum Ratings indicate limits beyond which damage to the device may occur. Operating Ratings indicate conditions for which the device is intended to be functional, but specific performance is not guaranteed. For guaranteed specifications and the test conditions, see the Electrical Characteristics.

**Note 2:** Human Body Model (HBM) is 1.5 k $\Omega$  in series with 100 pF.

**Note 3:** Electrical Table values apply only for factory testing conditions at the temperature indicated. Factory testing conditions result in very limited self-heating of the device such that  $T_J = T_A$ . No guarantee of parametric performance is indicated in the electrical tables under conditions of internal self-heating where  $T_J > T_A$ .

**Note 4:** All limits are guaranteed by design or statistical analysis.

**Note 5:** Typical values represent the most likely parametric norm.

**Note 6:** The maximum power dissipation is a function of  $T_{J(MAX)}$ ,  $\theta_{JA}$  and  $T_A$ . The maximum allowable power dissipation at any ambient temperature is  $P_D = (T_{J(MAX)} - T_A)/\theta_{JA}$ . All numbers apply for packages soldered directly into a PC board.

## Connection Diagram

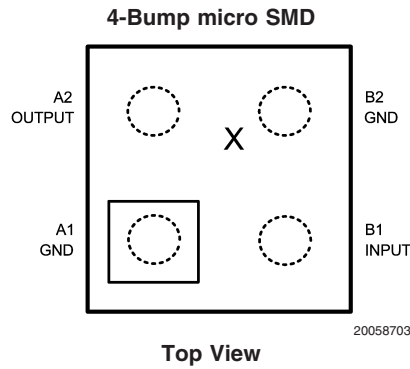

**Note:** - Pin numbers are referenced to package marking text orientation.

- The actual physical placement of the package marking will vary slightly from part to part. The package will designate the date code and will vary considerably. Package marking does not correlate to device type in any way.

## Ordering Information

Package	Part Number	Package Marking	Transport Media	NSC Drawing
4-Bump Extreme Thin micro SMD (0.3 mm max height) lead free only	LMV1012XP-15	Date Code	250 Units Tape and Reel	XPA04HLA
	LMV1012XPX-15		3k Units Tape and Reel	
	LMV1012XP-25		250 Units Tape and Reel	
	LMV1012XPX-25		3k Units Tape and Reel	
4-Bump Ultra-Thin micro SMD (0.4 mm max height) lead free only	LMV1012UP-07	Date Code	250 Units Tape and Reel	UPA04GKA
	LMV1012UPX-07		3k Units Tape and Reel	
	LMV1012UP-15		250 Units Tape and Reel	
	LMV1012UPX-15		3k Units Tape and Reel	
	LMV1012UP-20		250 Units Tape and Reel	
	LMV1012UPX-20		3k Units Tape and Reel	
	LMV1012UP-25		250 Units Tape and Reel	
	LMV1012UPX-25		3k Units Tape and Reel	
4-Bump Thin micro SMD (0.5 mm max height) lead free only	LMV1012TP-07	Date Code	250 Units Tape and Reel	TPA04GKA
	LMV1012TPX-07		3k Units Tape and Reel	
	LMV1012TP-15		250 Units Tape and Reel	
	LMV1012TPX-15		3k Units Tape and Reel	
	LMV1012TP-25		250 Units Tape and Reel	
	LMV1012TPX-25		3k Units Tape and Reel	

### Typical Performance Characteristics

Unless otherwise specified,  $V_S = 2.2V$ ,  $R_L = 2.2 k\Omega$ ,

$C = 2.2 \mu F$ , single supply,  $T_A = 25^\circ C$

Supply Current vs. Supply Voltage (LMV1012-07)

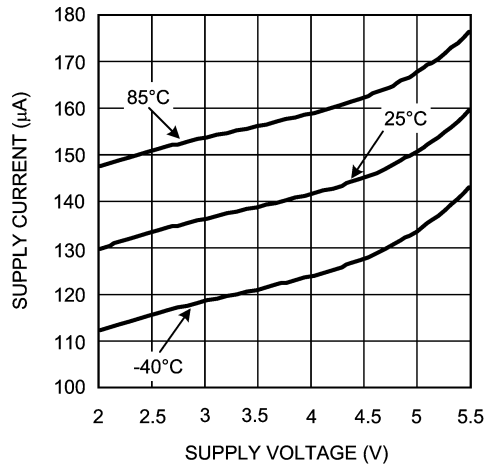

20058718

Supply Current vs. Supply Voltage (LMV1012-15)

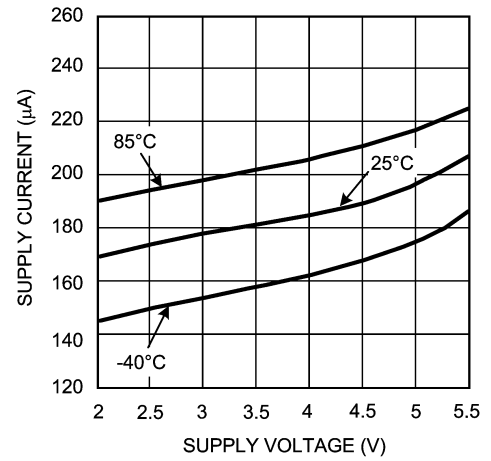

20058704

Supply Current vs. Supply Voltage (LMV1012-20)

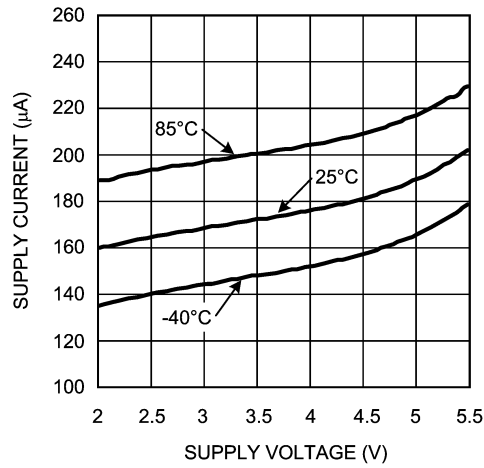

20058724

Supply Current vs. Supply Voltage (LMV1012-25)

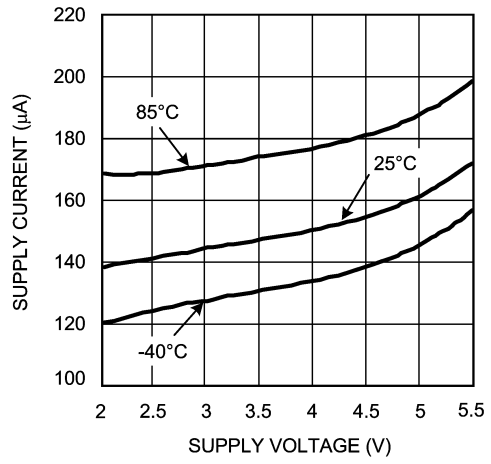

20058719

Gain and Phase vs. Frequency (LMV1012-07)

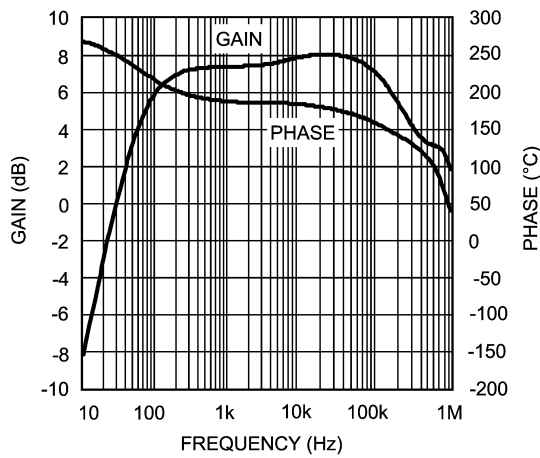

20058714

Gain and Phase vs. Frequency (LMV1012-15)

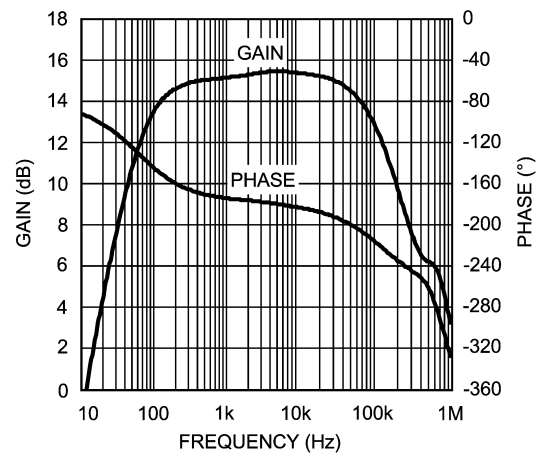

20058705

## Typical Performance Characteristics Unless otherwise specified, $V_S = 2.2V$ , $R_L = 2.2 k\Omega$ ,

$C = 2.2 \mu F$ , single supply,  $T_A = 25^\circ C$  (Continued)

**Gain and Phase vs. Frequency (LMV1012-20)**

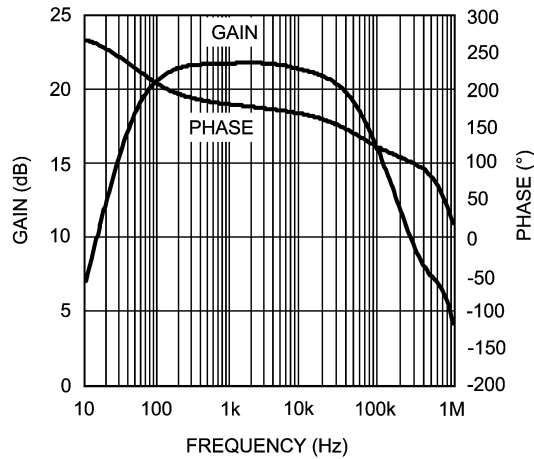

20058725

**Gain and Phase vs. Frequency (LMV1012-25)**

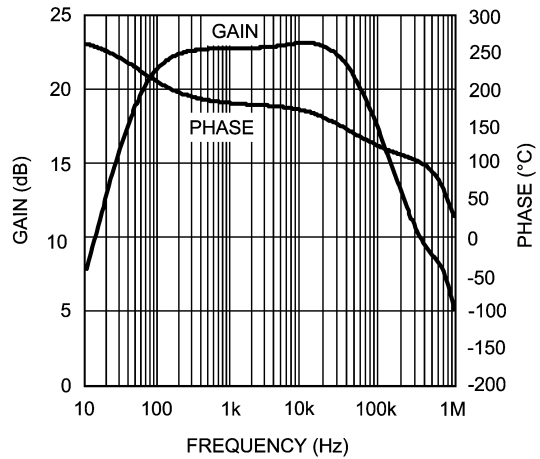

20058713

**Total Harmonic Distortion vs. Frequency (LMV1012-07)**

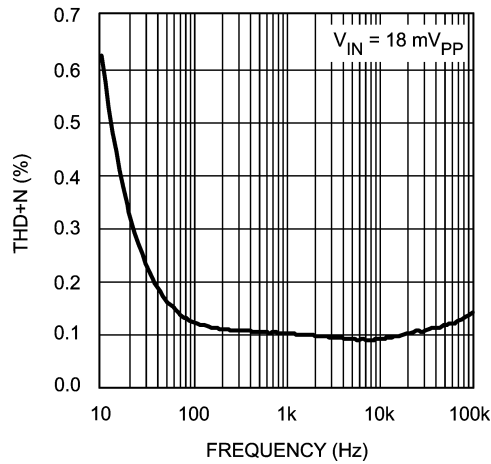

20058720

**Total Harmonic Distortion vs. Frequency (LMV1012-15)**

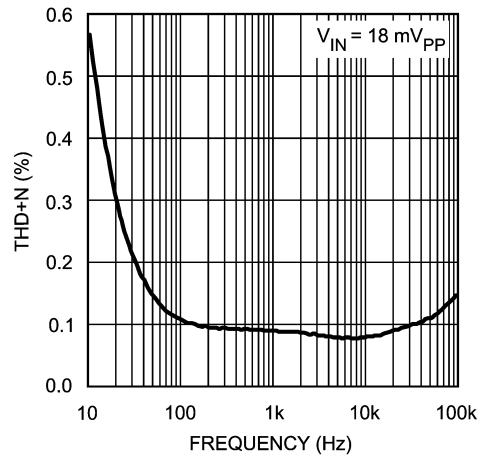

20058706

**Total Harmonic Distortion vs. Frequency (LMV1012-20)**

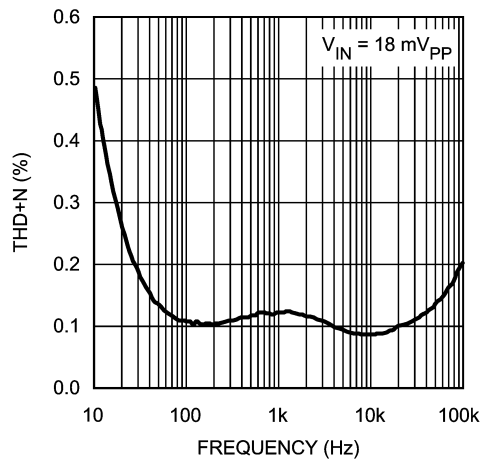

20058726

**Total Harmonic Distortion vs. Frequency (LMV1012-25)**

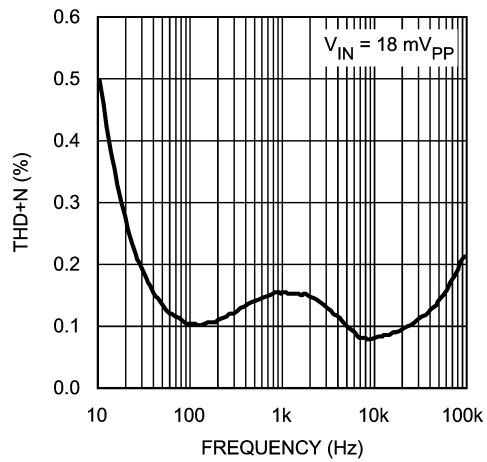

20058721



**Typical Performance Characteristics** Unless otherwise specified,  $V_S = 2.2V$ ,  $R_L = 2.2 k\Omega$ ,  $C = 2.2 \mu F$ , single supply,  $T_A = 25^\circ C$  (Continued)

**Total Harmonic Distortion vs. Input Voltage (LMV1012-07)**

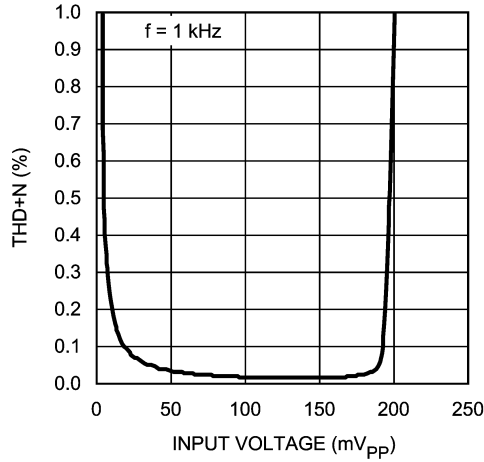

20058722

**Total Harmonic Distortion vs. Input Voltage (LMV1012-15)**

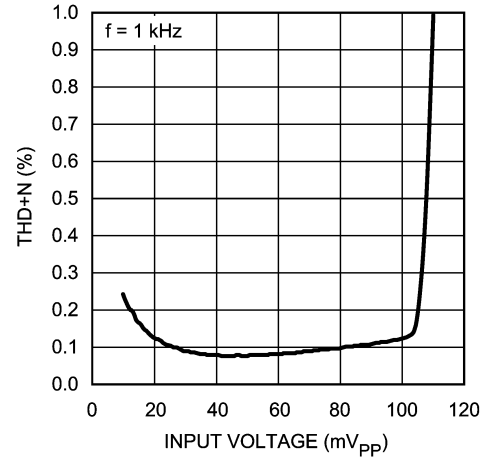

20058707

**Total Harmonic Distortion vs. Input Voltage (LMV1012-20)**

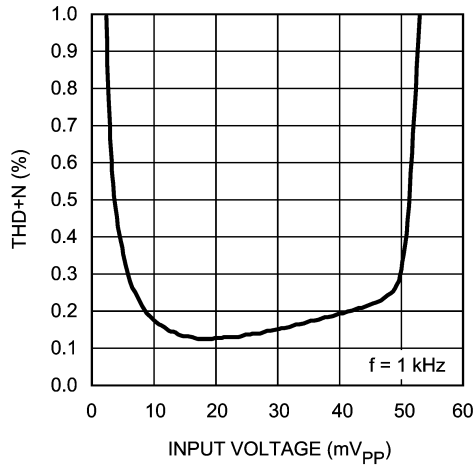

20058727

**Total Harmonic Distortion vs. Input Voltage (LMV1012-25)**

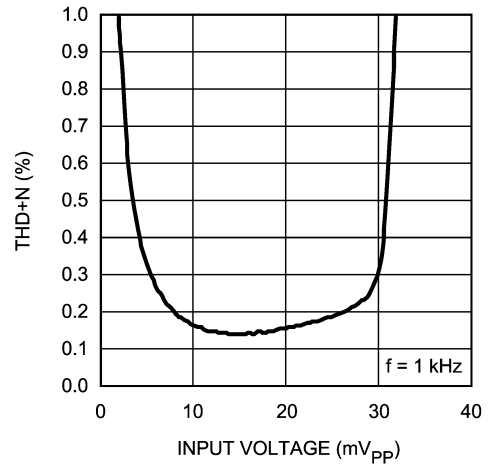

20058723

**Output Noise vs. Frequency (LMV1012-07)**

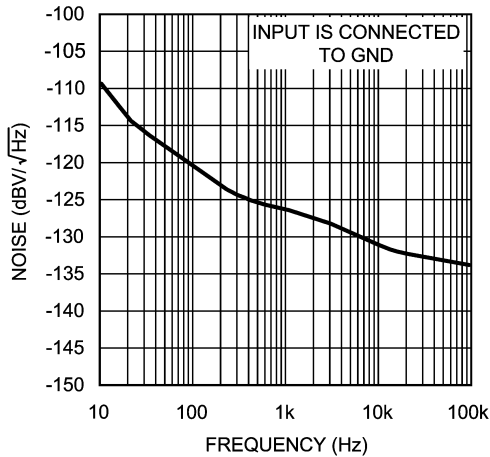

20058717

**Output Noise vs. Frequency (LMV1012-15)**

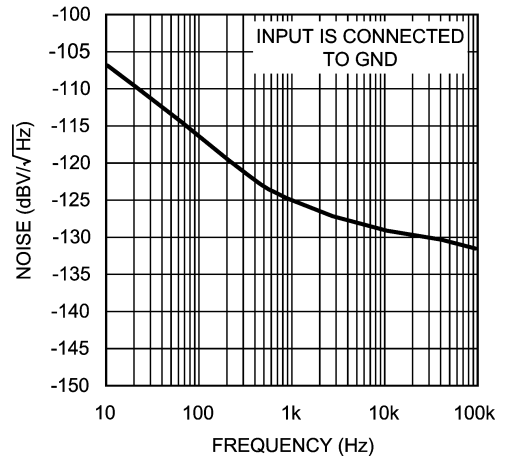

20058715

**Typical Performance Characteristics** Unless otherwise specified,  $V_S = 2.2V$ ,  $R_L = 2.2 k\Omega$ ,  $C = 2.2 \mu F$ , single supply,  $T_A = 25^\circ C$  (Continued)

Output Noise vs. Frequency (LMV1012-20)

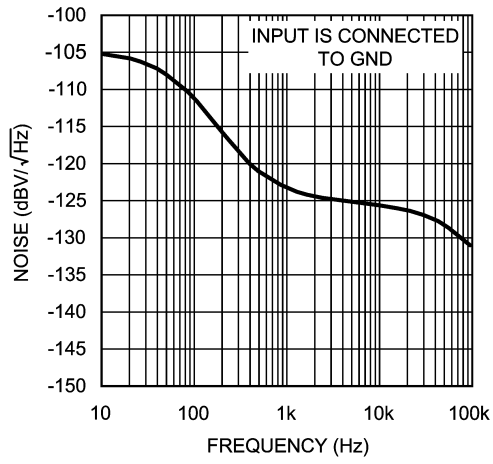

Output Noise vs. Frequency (LMV1012-25)

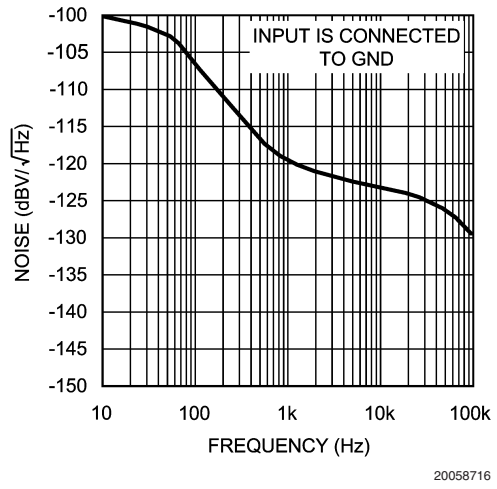

## Application Section

### HIGH GAIN

The LMV1012 series provides outstanding gain versus the JFET and still maintains the same ease of implementation, with improved gain, linearity and temperature stability. A high gain eliminates the need for extra external components.

### BUILT IN GAIN

The LMV1012 is offered in 0.3 mm height space saving small 4-pin micro SMD packages in order to fit inside the different size ECM canisters of a microphone. The LMV1012 is placed on the PCB inside the microphone.

The bottom side of the PCB usually shows a bull's eye pattern where the outer ring, which is shorted to the metal can, should be connected to the ground. The center dot on the PCB is connected to the  $V_{DD}$  through a resistor. This phantom biasing allows both supply voltage and output signal on one connection.

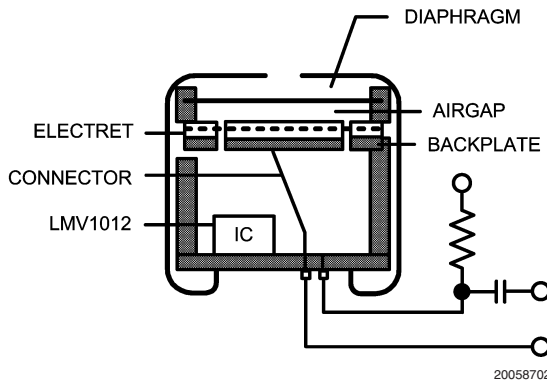
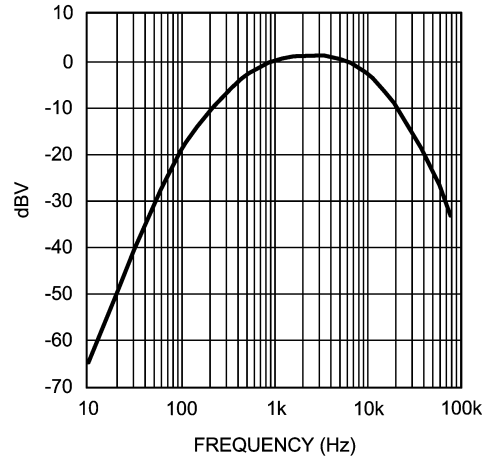

FIGURE 1. Built in Gain

### A-WEIGHTED FILTER

The human ear has a frequency range from 20 Hz to about 20 kHz. Within this range the sensitivity of the human ear is not equal for each frequency. To approach the hearing response weighting filters are introduced. One of those filters is the A-weighted filter.

The A-weighted filter is usually used in signal to noise ratio measurements, where sound is compared to device noise. This filter improves the correlation of the measured data to the signal to noise ratio perceived by the human ear.



20058709

FIGURE 2. A-Weighted Filter

### MEASURING NOISE AND SNR

The overall noise of the LMV1012 is measured within the frequency band from 10 Hz to 22 kHz using an A-weighted filter. The input of the LMV1012 is connected to ground with a 5 pF capacitor, as in Figure 3. Special precautions in the internal structure of the LMV1012 have been taken to reduce the noise on the output.

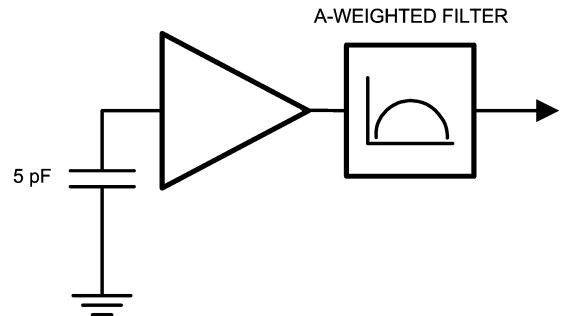

20058710

FIGURE 3. Noise Measurement Setup

The signal to noise ratio (SNR) is measured with a 1 kHz input signal of 18 mV<sub>PP</sub> using an A-weighted filter. This represents a sound pressure level of 94 dB SPL. No input capacitor is connected for the measurement.

### SOUND PRESSURE LEVEL

The volume of sound applied to a microphone is usually stated as a pressure level referred to the threshold of hearing of the human ear. The sound pressure level (SPL) in decibels is defined by:

$$\text{Sound pressure level (dB)} = 20 \log P_m/P_o$$

Where,

$P_m$  is the measured sound pressure

$P_o$  is the threshold of hearing (20  $\mu$ Pa)

In order to be able to calculate the resulting output voltage of the microphone for a given SPL, the sound pressure in dB

## Application Section (Continued)

SPL needs to be converted to the absolute sound pressure in dBPa. This is the sound pressure level in decibels referred to 1 Pascal (Pa).

The conversion is given by:

$$\text{dBPa} = \text{dB SPL} + 20 \cdot \log 20 \mu\text{Pa}$$

$$\text{dBPa} = \text{dB SPL} - 94 \text{ dB}$$

Translation from absolute sound pressure level to a voltage is specified by the sensitivity of the microphone. A conventional microphone has a sensitivity of -44 dBV/Pa.

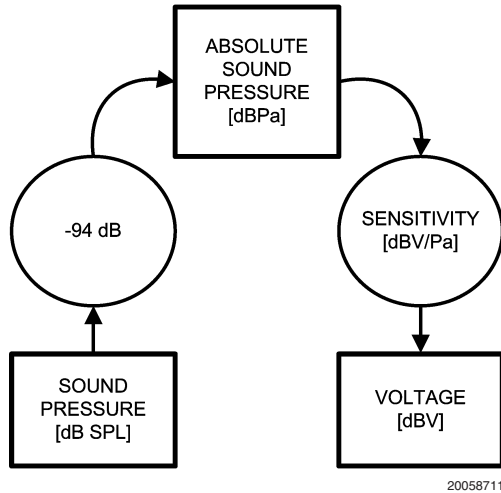

**FIGURE 4. dB SPL to dBV Conversion**

Example: Busy traffic is 70 dB SPL

$$V_{\text{OUT}} = 70 - 94 - 44 = -68 \text{ dBV}$$

This is equivalent to 1.13 mV<sub>PP</sub>

Since the LMV1012-15 has a gain of 6 (15.6 dB) over the JFET, the output voltage of the microphone is 6.78 mV<sub>PP</sub>. By implementing the LMV1012-15, the sensitivity of the microphone is -28.4 dBV/Pa (-44 + 15.6).

### LOW FREQUENCY CUT OFF FILTER

To reduce noise on the output of the microphone a low frequency cut off filter has been implemented. This filter reduces the effect of wind and handling noise.

It's also helpful to reduce the proximity effect in directional microphones. This effect occurs when the sound source is very close to the microphone. The lower frequencies are

amplified which gives a bass sound. This amplification can cause an overload, which results in a distortion of the signal.

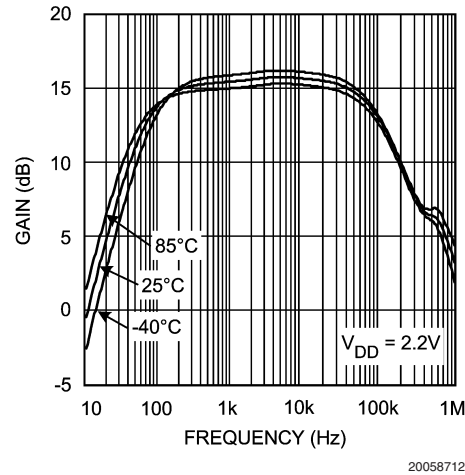

**FIGURE 5. LMV1012-15 Gain vs. Frequency Over Temperature**

The LMV1012 is optimized to be used in audio band applications. By using the LMV1012, the gain response is flat within the audio band and has linearity and temperature stability *Figure 5*.

### NOISE

Noise pick-up by a microphone in cell phones is a well-known problem. A conventional JFET circuit is sensitive for noise pick-up because of its high output impedance, which is usually around 2.2 kΩ.

RF noise is amongst other caused by non-linear behavior. The non-linear behavior of the amplifier at high frequencies, well above the usable bandwidth of the device, causes AM-demodulation of high frequency signals. The AM modulation contained in such signals folds back into the audio band, thereby disturbing the intended microphone signal. The GSM signal of a cell phone is such an AM-modulated signal. The modulation frequency of 216 Hz and its harmonics can be observed in the audio band. This kind of noise is called bumblebee noise.

RF noise caused by a GSM signal can be reduced by connecting two external capacitors to ground, see *Figure 6*. One capacitor reduces the noise caused by the 900 MHz carrier and the other reduces the noise caused by 1800/1900 MHz.

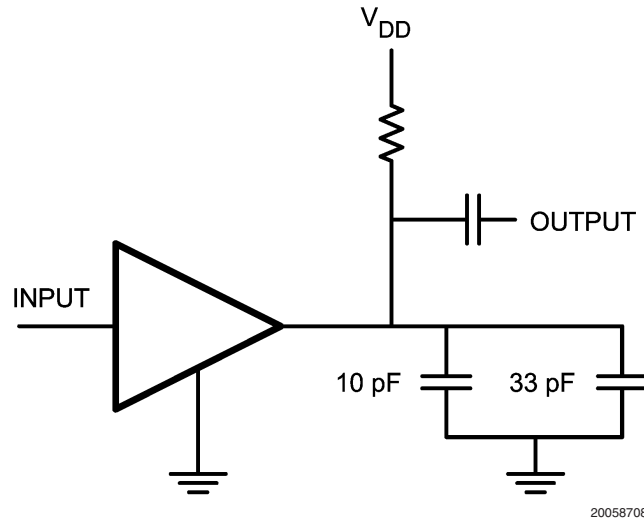
**Application Section** (Continued)**FIGURE 6. RF Noise Reduction**

**Physical Dimensions** inches (millimeters) unless otherwise noted

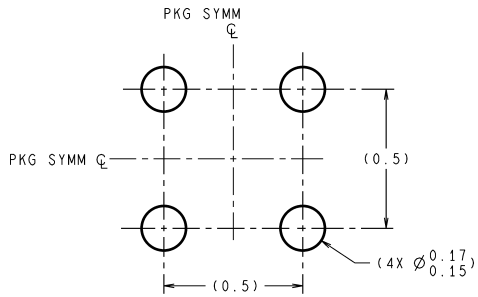

**DIMENSIONS ARE IN MILLIMETERS**  
DIMENSIONS IN ( ) FOR REFERENCE ONLY

**LAND PATTERN RECOMMENDATION**

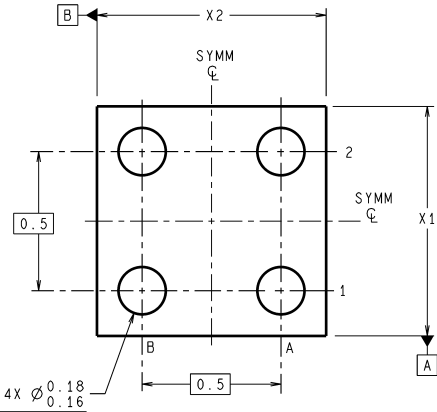
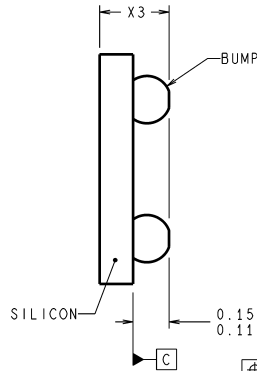
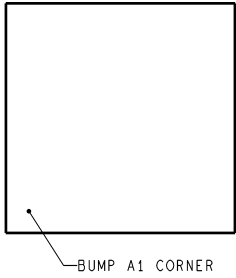

Φ 0.001 C A B

XPA04XXX (Rev B)

NOTE: UNLESS OTHERWISE SPECIFIED.

1. FOR SOLDER BUMP COMPOSITION, SEE "SOLDER INFORMATION" IN THE PACKAGING SECTION OF THE NATIONAL SEMICONDUCTOR WEB PAGE ([www.national.com](http://www.national.com)).
2. RECOMMEND NON-SOLDER MASK DEFINED LANDING PAD.
3. PIN A1 IS ESTABLISHED BY LOWER LEFT CORNER WITH RESPECT TO TEXT ORIENTATION.
4. XXX IN DRAWING NUMBER REPRESENTS PACKAGE SIZE VARIATION WHERE X1 IS PACKAGE WIDTH, X2 IS PACKAGE LENGTH AND X3 IS PACKAGE HEIGHT.
5. REFERENCE JEDEC REGISTRATION MO-211. VARIATION CA.

**4-Bump Extreme Thin micro SMD**  
**NS Package Number XPA04HLA**  
**X1 = 0.955 mm X2 = 1.031 mm X3 = 0.300 mm**

**Physical Dimensions** inches (millimeters) unless otherwise noted (Continued)

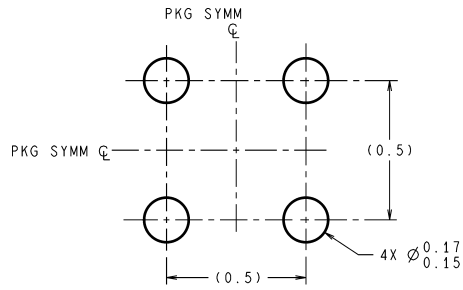

**DIMENSIONS ARE IN MILLIMETERS**  
DIMENSIONS IN ( ) FOR REFERENCE ONLY

**LAND PATTERN RECOMMENDATION**

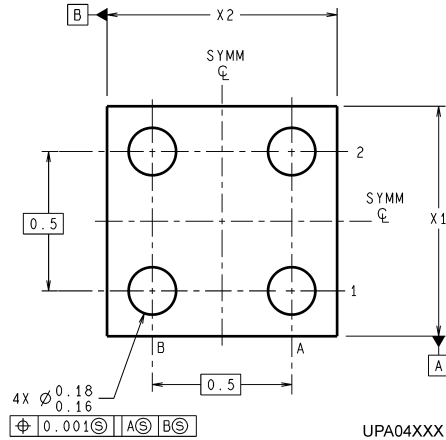
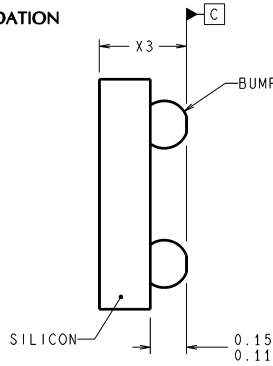
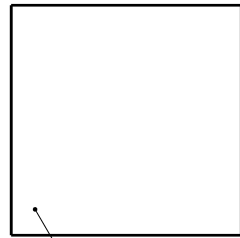

UPA04XXX (Rev C)

NOTE: UNLESS OTHERWISE SPECIFIED.

1. FOR SOLDER BUMP COMPOSITION, SEE "SOLDER INFORMATION" IN THE PACKAGING SECTION OF THE NATIONAL SEMICONDUCTOR WEB PAGE ([www.national.com](http://www.national.com)).
2. RECOMMEND NON-SOLDER MASK DEFINED LANDING PAD.
3. PIN A1 IS ESTABLISHED BY LOWER LEFT CORNER WITH RESPECT TO TEXT ORIENTATION.
4. XXX IN DRAWING NUMBER REPRESENTS PACKAGE SIZE VARIATION WHERE X1 IS PACKAGE WIDTH, X2 IS PACKAGE LENGTH AND X3 IS PACKAGE HEIGHT.
5. REFERENCE JEDEC REGISTRATION MO-211. VARIATION CA.

**4-Bump ULTRA-Thin micro SMD**  
**NS Package Number UPA04GKA**  
**X1 = 0.93 mm X2 = 1.006 mm X3 = 0.400 mm**

**Physical Dimensions** inches (millimeters) unless otherwise noted (Continued)

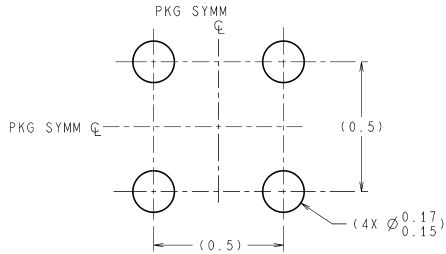

DIMENSIONS ARE IN MILLIMETERS

**LAND PATTERN RECOMMENDATION**

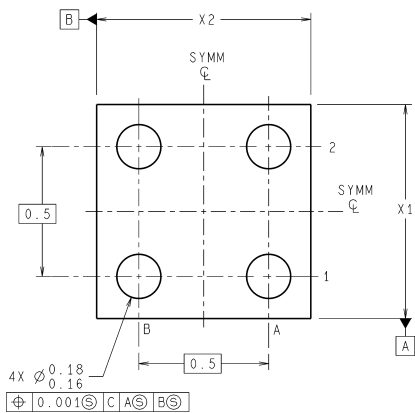
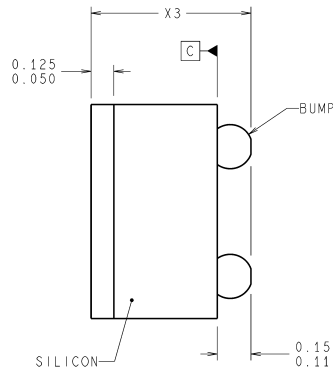
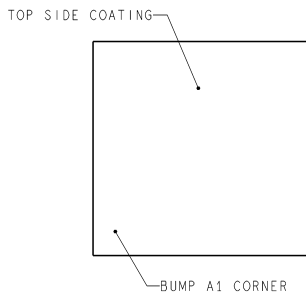

TPA04XXX (Rev B)

NOTE: UNLESS OTHERWISE SPECIFIED.

1. EPOXY COATING.
2. 63Sn/37Pb EUTECTIC BUMP.
3. RECOMMEND NON-SOLDER MASK DEFINED LANDING PAD.
4. PIN A1 IS ESTABLISHED BY LOWER LEFT CORNER WITH RESPECT TO TEXT ORIENTATION PINS ARE NUMBERED COUNTERCLOCKWISE.
5. XXX IN DRAWING NUMBER REPRESENTS PACKAGE SIZE VARIATION WHERE X1 IS PACKAGE WIDTH, X2 IS PACKAGE LENGTH AND X3 IS PACKAGE HEIGHT.
6. REFERENCE JEDEC REGISTRATION MO-211. VARIATION BC.

**4-Bump Thin micro SMD**  
**NS Package Number TPA04GKA**  
**X1 = 0.93 mm X2 = 1.006 mm X3 = 0.500 mm**

National does not assume any responsibility for use of any circuitry described, no circuit patent licenses are implied and National reserves the right at any time without notice to change said circuitry and specifications.

For the most current product information visit us at [www.national.com](http://www.national.com).

**LIFE SUPPORT POLICY**

NATIONAL'S PRODUCTS ARE NOT AUTHORIZED FOR USE AS CRITICAL COMPONENTS IN LIFE SUPPORT DEVICES OR SYSTEMS WITHOUT THE EXPRESS WRITTEN APPROVAL OF THE PRESIDENT AND GENERAL COUNSEL OF NATIONAL SEMICONDUCTOR CORPORATION. As used herein:

1. Life support devices or systems are devices or systems which, (a) are intended for surgical implant into the body, or (b) support or sustain life, and whose failure to perform when properly used in accordance with instructions for use provided in the labeling, can be reasonably expected to result in a significant injury to the user.
2. A critical component is any component of a life support device or system whose failure to perform can be reasonably expected to cause the failure of the life support device or system, or to affect its safety or effectiveness.

**BANNED SUBSTANCE COMPLIANCE**

National Semiconductor manufactures products and uses packing materials that meet the provisions of the Customer Products Stewardship Specification (CSP-9-111C2) and the Banned Substances and Materials of Interest Specification (CSP-9-111S2) and contain no "Banned Substances" as defined in CSP-9-111S2.

Leadfree products are RoHS compliant.



**National Semiconductor**  
**Americas Customer Support Center**  
 Email: [new.feedback@nsc.com](mailto:new.feedback@nsc.com)  
 Tel: 1-800-272-9959

**National Semiconductor**  
**Europe Customer Support Center**  
 Fax: +49 (0) 180-530 85 86  
 Email: [europe.support@nsc.com](mailto:europe.support@nsc.com)  
 Deutsch Tel: +49 (0) 69 9508 6208  
 English Tel: +44 (0) 870 24 0 2171  
 Français Tel: +33 (0) 1 41 91 8790

**National Semiconductor**  
**Asia Pacific Customer Support Center**  
 Email: [ap.support@nsc.com](mailto:ap.support@nsc.com)

**National Semiconductor**  
**Japan Customer Support Center**  
 Fax: 81-3-5639-7507  
 Email: [jpn.feedback@nsc.com](mailto:jpn.feedback@nsc.com)  
 Tel: 81-3-5639-7560

[www.national.com](http://www.national.com)



## IMPORTANT NOTICE

Texas Instruments Incorporated and its subsidiaries (TI) reserve the right to make corrections, modifications, enhancements, improvements, and other changes to its products and services at any time and to discontinue any product or service without notice. Customers should obtain the latest relevant information before placing orders and should verify that such information is current and complete. All products are sold subject to TI's terms and conditions of sale supplied at the time of order acknowledgment.

TI warrants performance of its hardware products to the specifications applicable at the time of sale in accordance with TI's standard warranty. Testing and other quality control techniques are used to the extent TI deems necessary to support this warranty. Except where mandated by government requirements, testing of all parameters of each product is not necessarily performed.

TI assumes no liability for applications assistance or customer product design. Customers are responsible for their products and applications using TI components. To minimize the risks associated with customer products and applications, customers should provide adequate design and operating safeguards.

TI does not warrant or represent that any license, either express or implied, is granted under any TI patent right, copyright, mask work right, or other TI intellectual property right relating to any combination, machine, or process in which TI products or services are used. Information published by TI regarding third-party products or services does not constitute a license from TI to use such products or services or a warranty or endorsement thereof. Use of such information may require a license from a third party under the patents or other intellectual property of the third party, or a license from TI under the patents or other intellectual property of TI.

Reproduction of TI information in TI data books or data sheets is permissible only if reproduction is without alteration and is accompanied by all associated warranties, conditions, limitations, and notices. Reproduction of this information with alteration is an unfair and deceptive business practice. TI is not responsible or liable for such altered documentation. Information of third parties may be subject to additional restrictions.

Resale of TI products or services with statements different from or beyond the parameters stated by TI for that product or service voids all express and any implied warranties for the associated TI product or service and is an unfair and deceptive business practice. TI is not responsible or liable for any such statements.

TI products are not authorized for use in safety-critical applications (such as life support) where a failure of the TI product would reasonably be expected to cause severe personal injury or death, unless officers of the parties have executed an agreement specifically governing such use. Buyers represent that they have all necessary expertise in the safety and regulatory ramifications of their applications, and acknowledge and agree that they are solely responsible for all legal, regulatory and safety-related requirements concerning their products and any use of TI products in such safety-critical applications, notwithstanding any applications-related information or support that may be provided by TI. Further, Buyers must fully indemnify TI and its representatives against any damages arising out of the use of TI products in such safety-critical applications.

TI products are neither designed nor intended for use in military/aerospace applications or environments unless the TI products are specifically designated by TI as military-grade or "enhanced plastic." Only products designated by TI as military-grade meet military specifications. Buyers acknowledge and agree that any such use of TI products which TI has not designated as military-grade is solely at the Buyer's risk, and that they are solely responsible for compliance with all legal and regulatory requirements in connection with such use.

TI products are neither designed nor intended for use in automotive applications or environments unless the specific TI products are designated by TI as compliant with ISO/TS 16949 requirements. Buyers acknowledge and agree that, if they use any non-designated products in automotive applications, TI will not be responsible for any failure to meet such requirements.

Following are URLs where you can obtain information on other Texas Instruments products and application solutions:

### Products

Audio	<a href="http://www.ti.com/audio">www.ti.com/audio</a>
Amplifiers	<a href="http://amplifier.ti.com">amplifier.ti.com</a>
Data Converters	<a href="http://dataconverter.ti.com">dataconverter.ti.com</a>
DLP® Products	<a href="http://www.dlp.com">www.dlp.com</a>
DSP	<a href="http://dsp.ti.com">dsp.ti.com</a>
Clocks and Timers	<a href="http://www.ti.com/clocks">www.ti.com/clocks</a>
Interface	<a href="http://interface.ti.com">interface.ti.com</a>
Logic	<a href="http://logic.ti.com">logic.ti.com</a>
Power Mgmt	<a href="http://power.ti.com">power.ti.com</a>
Microcontrollers	<a href="http://microcontroller.ti.com">microcontroller.ti.com</a>
RFID	<a href="http://www.ti-rfid.com">www.ti-rfid.com</a>
OMAP Mobile Processors	<a href="http://www.ti.com/omap">www.ti.com/omap</a>
Wireless Connectivity	<a href="http://www.ti.com/wirelessconnectivity">www.ti.com/wirelessconnectivity</a>

### Applications

Communications and Telecom	<a href="http://www.ti.com/communications">www.ti.com/communications</a>
Computers and Peripherals	<a href="http://www.ti.com/computers">www.ti.com/computers</a>
Consumer Electronics	<a href="http://www.ti.com/consumer-apps">www.ti.com/consumer-apps</a>
Energy and Lighting	<a href="http://www.ti.com/energy">www.ti.com/energy</a>
Industrial	<a href="http://www.ti.com/industrial">www.ti.com/industrial</a>
Medical	<a href="http://www.ti.com/medical">www.ti.com/medical</a>
Security	<a href="http://www.ti.com/security">www.ti.com/security</a>
Space, Avionics and Defense	<a href="http://www.ti.com/space-avionics-defense">www.ti.com/space-avionics-defense</a>
Transportation and Automotive	<a href="http://www.ti.com/automotive">www.ti.com/automotive</a>
Video and Imaging	<a href="http://www.ti.com/video">www.ti.com/video</a>

TI E2E Community Home Page

[e2e.ti.com](http://e2e.ti.com)

Mailing Address: Texas Instruments, Post Office Box 655303, Dallas, Texas 75265  
Copyright © 2011, Texas Instruments Incorporated