

ISL8022

Dual 2A/1.7A Low Quiescent Current 2.25MHz High Efficiency Synchronous Buck Regulator

FN7650
Rev 3.00
March 14, 2013

The ISL8022 is a high efficiency, dual synchronous step-down DC/DC regulator that can deliver up to 2A/1.7A continuous output current per channel. The channels are 180° out-of-phase for input RMS current and EMI reduction. The supply voltage range of 2.8V to 5.5V allows for the use of a single Li+ cell, three NiMH cells or a regulated 5V input. The current mode control architecture enables very low duty cycle operation at high frequency with fast transient response and excellent loop stability. The ISL8022 operates at 2.25MHz switching frequency allowing for the use of small, low cost inductors and capacitors. Each channel is optimized for generating an output voltage as low as 0.6V.

The ISL8022 has a user configurable mode of operation-forced PWM mode and PFM/PWM mode. The forced PWM mode operation reduces noise and RF interference while the PFM mode operation provides high efficiency by reducing switching losses at light loads. In PFM mode of operation, both channels draw a total quiescent current of only 40µA, hence enabling high light load efficiency in order to maximize battery life.

The ISL8022 offers a 1ms Power-Good (PG) to monitor both outputs at power-up. When shutdown, ISL8022 discharges the outputs capacitor. Other features include internal digital soft-start, enable for power sequence, overcurrent protection, and thermal shutdown. The ISL8022 is offered in a 4mmx3mm 12 Ld DFN package with 1mm maximum height. The complete converter occupies less than 1.8cm² area.

Features

- Dual 2A/1.7A high efficiency synchronous buck regulator with up to 97% efficiency, low iq (40µA)
- 180° out-of-phase
- Start-up with pre-biased output
- Selectable forced PWM mode and PFM mode
- External synchronization up to 8MHz
- Negative current detection and protection
- 100% maximum duty cycle for lowest dropout
- Internal current mode compensation
- Peak current limiting, hiccup mode short circuit protection and over-temperature protection
- Pb-free (RoHs compliant)

Applications

- DC/DC POL modules
- µC/µP, FPGA and DSP power
- Plug-in DC/DC modules for routers and switchers
- Test and measurement systems
- Li-ion battery powered devices
- Bar code readers

Related Literature

- [AN1554](#) "ISL8022EVAL1Z Dual 2A/1.7A Low Quiescent Current 2.25MHz High Efficiency Synchronous Buck Regulator"
- [AN1587](#) "ISL8022EVAL2Z Dual 2A/1.7A Low Quiescent Current 2.25MHz High Efficiency Synchronous Buck Regulator"

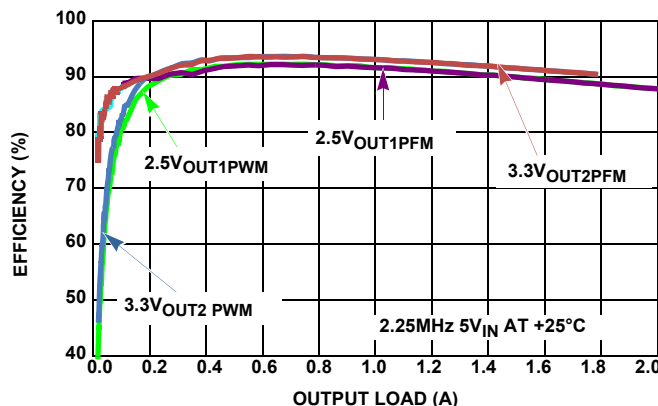

FIGURE 1. CHARACTERISTIC CURVE

Typical Applications

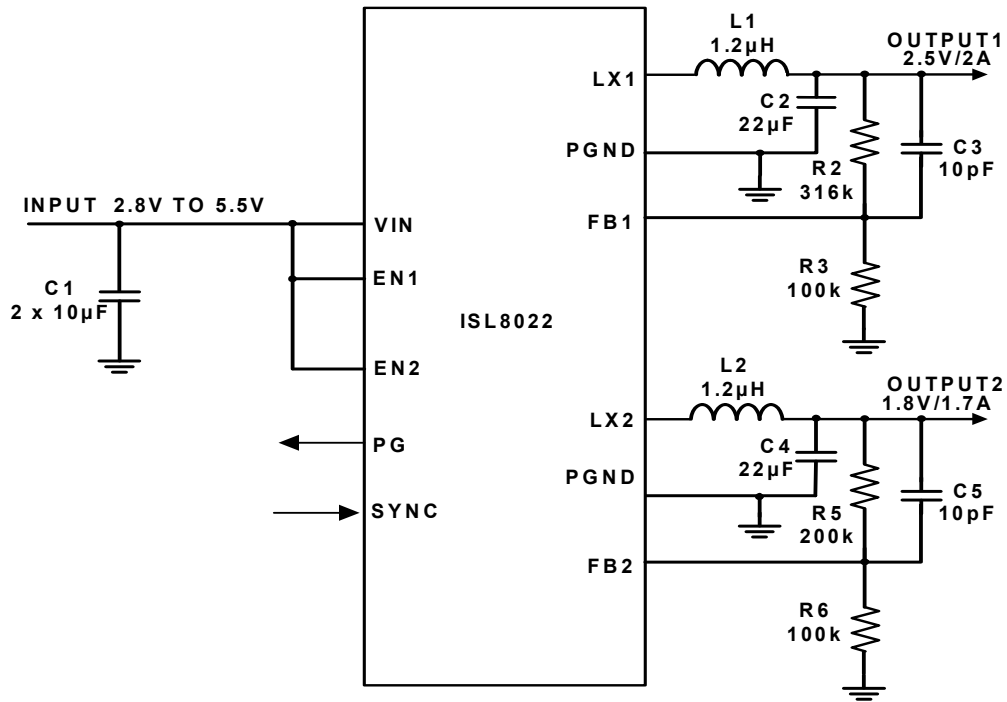

FIGURE 2. TYPICAL APPLICATION DIAGRAM - DUAL INDEPENDENT OUTPUTS

TABLE 1. COMPONENT VALUE SELECTION

V _{OUT}	0.8V	1.2V	1.5V	1.8V	2.5V	3.3V
C1	2x10µF	2x10µF	2x10µF	2x10µF	2x10µF	2x10µF
C2 (or C4)	22µF	22µF	22µF	22µF	22µF	22µF
C3 (or C5)	10pF	10pF	10pF	10pF	10pF	10pF
L1 (or L2)	1.0~2.2µH	1.0~2.2µH	1.0~2.2µH	1.2~3.3µH	1.2~3.3µH	1.5~4.7µH
R2 (or R5)	33k	100k	150k	200k	316k	450k
R3 (or R6)	100k	100k	100k	100k	100k	100k

In Table 1, the minimum output capacitor value is given for different output voltage to make sure the whole converter system is stable. Output capacitance should increase to support faster load transient requirement.

Ordering Information

PART NUMBER (Notes 1, 2, 3)	PART MARKING	TEMP. RANGE (°C)	PACKAGE (Pb-Free)	PKG. DWG. #
ISL8022IRZ	8022	-40 to +85	12 Ld 4x3 DFN	L12.4x3
ISL8022EVAL1Z	Evaluation Board			
ISL8022EVAL2Z	Evaluation Board			

NOTES:

1. Add "T" suffix for Tape and Reel. Please refer to [TB347](#) for details on reel specifications.
2. These Intersil Pb-free plastic packaged products employ special Pb-free material sets, molding compounds/die attach materials, and 100% matte tin plate plus anneal (e3 termination finish, which is RoHS compliant and compatible with both SnPb and Pb-free soldering operations). Intersil Pb-free products are MSL classified at Pb-free peak reflow temperatures that meet or exceed the Pb-free requirements of IPC/JEDEC J STD-020.
3. For Moisture Sensitivity Level (MSL), please see device information page for [ISL8022](#). For more information on MSL please see techbrief [TB363](#).

Pin Configuration

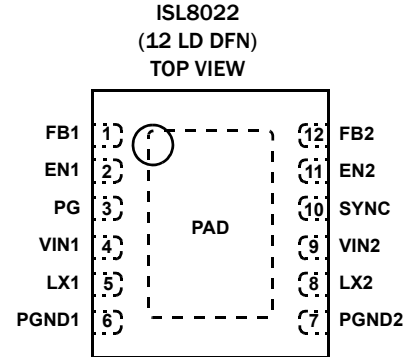

Pin Description

PIN NUMBER	SYMBOL	DESCRIPTION
1	FB1	The feedback network of the Channel 1 regulator. FB1 is the negative input to the transconductance error amplifier. The output voltage is set by an external resistor divider connected to FB1. With a properly selected divider, the output voltage can be set to any voltage between the power rail (reduced by converter losses) and the 0.6V reference. There is an internal compensation to meet a typical application. In addition, the regulator power-good and undervoltage protection circuitry use FB1 to monitor the Channel 1 regulator output voltage.
2	EN1	Regulator Channel 1 enable pin. Enable the output, V_{OUT1} , when driven to high. Shutdown the V_{OUT1} and discharge output capacitor when driven to low. Do not leave this pin floating.
3	PG	1ms timer output. At power-up or EN_HI, this output is a 1ms delayed Power-Good signal for both the V_{OUT1} and V_{OUT2} voltages. There is an internal 1M Ω pull-up resistor.
4	VIN1	Input supply voltage for Channel 1. Connect 10 μ F ceramic capacitor to PGND1.
5	LX1	Switching node connection for Channel 1. Connect to one terminal of inductor for V_{OUT1} .
6	PGND1	Negative supply for power stage 1.
7	PGND2	Negative supply for power stage 2 and system ground.
8	LX2	Switching node connection for Channel 2. Connect to one terminal of inductor for V_{OUT2} .
9	VIN2	Input supply voltage for Ch 2 and to provide logic bias. Make sure that V_{IN2} is $\geq V_{IN1}$. Connect 10 μ F ceramic capacitor to PGND2.
10	SYNC	Mode Selection pin. Connect to logic high or input voltage VIN for PFM mode; connect to logic low or ground for forced PWM mode. Connect to an external function generator for Synchronization. Negative edge trigger. Do not leave this pin floating.
11	EN2	Regulator Channel 2 enable pin. Enable the output, V_{OUT2} , when driven to high. Shutdown the V_{OUT2} and discharge output capacitor when driven to low. Do not leave this pin floating.
12	FB2	The feedback network of the Channel 2 regulator. FB2 is the negative input to the transconductance error amplifier. The output voltage is set by an external resistor divider connected to FB2. With a properly selected divider, the output voltage can be set to any voltage between the power rail (reduced by converter losses) and the 0.6V reference. There is an internal compensation to meet a typical application. In addition, the regulator power-good and undervoltage protection circuitry use FB2 to monitor the Channel 2 regulator output voltage.
-	EXPOSED PAD	The exposed pad must be connected to the SGND pin for proper electrical performance. Add as much vias as possible for optimal thermal performance.

Absolute Maximum Ratings (Reference to GND)

Supply Voltage (V_{IN})	-0.3V to 6V (DC) or 7V (20ms)
EN1, EN2, PG, SYNC	-0.3V to $V_{IN} + 0.3V$
LX1, LX2	-1.5V (100ns)/-0.3V (DC) to 6.5V (DC) or 7V (20ms)
FB1, FB2	-0.3V to 2.7V
ESD Rating	
Human Body Model	3kV
Machine Model	250V
Charged Device Model (Tested per JESD22-C101E)	2k
Latch Up (Tested per JESD-78B; Class 2, Level A)	100mA

Thermal Information

Thermal Resistance (Typical)	θ_{JA} ($^{\circ}C/W$)	θ_{JC} ($^{\circ}C/W$)
4x3 DFN Package (Notes 4, 5)	41	3
Junction Temperature Range	-55 $^{\circ}C$ to +150 $^{\circ}C$	
Storage Temperature Range	-65 $^{\circ}C$ to +150 $^{\circ}C$	
Pb-Free Reflow Profile	see link below http://www.intersil.com/pbfree/Pb-FreeReflow.asp	

Recommended Operating Conditions

V_{IN} Supply Voltage Range	2.8V to 5.5V
Load Current Range Channel 1	0A to 2A
Load Current Range Channel 2	0A to 1.7A
Ambient Temperature Range	-40 $^{\circ}C$ to +85 $^{\circ}C$

CAUTION: Do not operate at or near the maximum ratings listed for extended periods of time. Exposure to such conditions may adversely impact product reliability and result in failures not covered by warranty.

NOTES:

- θ_{JA} is measured in free air with the component mounted on a high effective thermal conductivity test board with "direct attach" features. See Tech Brief [TB379](#).
- θ_{JC} , "case temperature" location is at the center of the exposed metal pad on the package underside.

Electrical Specifications Unless otherwise noted, all parameter limits are established over the recommended operating conditions: $T_A = -40^{\circ}C$ to +85 $^{\circ}C$, $V_{IN} = 2.8V$ to 5.5V, EN1 = EN2 = V_{IN} , SYNC = 0V, L = 1.2 μH , C1 = 2 x 10 μF , C2 = C4 = 22 μF , $I_{OUT1} = 0A$ to 2A, $I_{OUT2} = 0A$ to 1.7A. (Typical values are at $T_A = +25^{\circ}C$, $V_{IN} = 3.6V$). **Boldface limits apply over the operating temperature range, -40 $^{\circ}C$ to +85 $^{\circ}C$.**

PARAMETER	SYMBOL	TEST CONDITIONS	MIN (Note 6)	TYP	MAX (Note 6)	UNITS
INPUT SUPPLY						
V_{IN} Undervoltage Lock-out Threshold	V_{UVLO}	Rising		2.5	2.8	V
		Falling	2.0	2.4		V
Quiescent Supply Current	I_{VIN}	SYNC = V_{IN} , EN1 = EN2 = V_{IN} , no switches switching		40	55	μA
		SYNC = GND, EN1 = EN2 = V_{IN} , $F_S = 2.25MHz$, no load at the output		0.86	1	mA
ShutDown Supply Current	I_{SD}	$V_{IN} = 5.5V$, EN1 = EN2 = GND		6.5	12	μA
OUTPUT REGULATION						
FB1, FB2 Regulation Voltage	$V_{FB_}$		0.590	0.6	0.610	V
FB1, FB2 Bias Current	$I_{FB_}$	VFB = 0.55V		0.1		μA
Output Voltage Accuracy		SYNC = V_{IN} , $I_o = 0A$ to 2A		± 1.5		%
		SYNC = GND, $I_o = 0A$ to 2A		± 1		%
Line Regulation		$V_{IN} = V_O + 0.5V$ to 5.5V (minimal 2.8V)		0.2		%/V
Soft-Start Ramp Time Cycle				1.3		ms
OVERCURRENT PROTECTION						
Dynamic Current limit ON-time	t_{OCON}			17		Clock pulses
Dynamic Current Limit OFF-time	t_{OCCOFF}			4		SS cycle
Peak Overcurrent Limit	I_{pk1}		2.7	3.2	3.6	A
	I_{pk2}		2.3	2.8	3.2	A
Peak SKIP Limit	I_{skip1}		520	610	730	mA
	I_{skip2}		520	610	730	mA

Electrical Specifications Unless otherwise noted, all parameter limits are established over the recommended operating conditions: $T_A = -40^\circ\text{C}$ to $+85^\circ\text{C}$, $V_{IN} = 2.8\text{V}$ to 5.5V , $EN1 = EN2 = V_{IN}$, $SYNC = 0\text{V}$, $L = 1.2\mu\text{H}$, $C1 = 2 \times 10\mu\text{F}$, $C2 = C4 = 22\mu\text{F}$, $I_{OUT1} = 0\text{A}$ to 2A , $I_{OUT2} = 0\text{A}$ to 1.7A . (Typical values are at $T_A = +25^\circ\text{C}$, $V_{IN} = 3.6\text{V}$). **Boldface limits apply over the operating temperature range, -40°C to $+85^\circ\text{C}$.**

PARAMETER	SYMBOL	TEST CONDITIONS	MIN (Note 6)	TYP	MAX (Note 6)	UNITS
Negative Current Limit	I_{valley1}		-2.2	-1.6	-1	A
	I_{valley2}		-2.2	-1.6	-1	A
LX1, LX2						
P-Channel MOSFET ON-Resistance		$V_{IN} = 5.5\text{V}$, $I_O = 200\text{mA}$ Channel 1		90	115	$\text{m}\Omega$
		$V_{IN} = 5.5\text{V}$, $I_O = 200\text{mA}$ Channel 2		100	125	$\text{m}\Omega$
N-Channel MOSFET ON-Resistance		$V_{IN} = 5.5\text{V}$, $I_O = 200\text{mA}$ Channel 1		80	103	$\text{m}\Omega$
		$V_{IN} = 5.5\text{V}$, $I_O = 200\text{mA}$ Channel 2		90	112	$\text{m}\Omega$
LX_ Maximum Duty Cycle				100		%
PWM Switching Frequency	F_S		1.8	2.25	2.7	MHz
Synchronization Range		(Note 7)	5.4		8	MHz
Channel 1 to Channel 2 Phase Shift		Rising edge to rising edge timing		180		$^\circ$
LX Minimum On Time		$SYNC = \text{High}$ (forced PWM mode)		65		ns
Soft Discharge Resistance	$R_{DIS_}$	$EN = \text{LOW}$	80	100	130	Ω
PG						
Output Low Voltage		Sinking 1mA, $V_{FB} = 0.5\text{V}$			0.4	V
PG Pin Leakage Current		$PG = V_{IN} = 3.6\text{V}$		0.01	0.1	μA
PG Pull-up Resistor				1		$\text{M}\Omega$
Internal PGOOD Low Rising Threshold		Percentage of nominal regulation voltage	85	91	97	%
Internal PGOOD Low Falling Threshold		Percentage of nominal regulation voltage	78	85	92	%
Delay Time (Rising Edge)				0.76		ms
Internal PGOOD Delay Time (Falling Edge)				2	4	μs
EN1, EN2, SYNC						
Logic Input Low					0.4	V
Logic Input High			1.4			V
SYNC Logic Input Leakage Current	I_{SYNC}	Pulled up to 5.5V		0.1	1	μA
Enable Logic Input Leakage Current	$I_{EN_}$			0.1	1	μA
Thermal Shutdown				150		$^\circ\text{C}$
Thermal Shutdown Hysteresis				25		$^\circ\text{C}$

NOTES:

- Parameters with MIN and/or MAX limits are 100% tested at $+25^\circ\text{C}$, unless otherwise specified. Temperature limits established by characterization and are not production tested.
- The operational frequency per switching channel will be half of the SYNC frequency.

Typical Operating Performance (Unless otherwise noted) operating conditions are:

$T_A = +25^\circ\text{C}$, $V_{IN} = 2.8\text{V to } 5.5\text{V}$, $EN = V_{IN}$, $L1 = L2 = 1.2\mu\text{H}$, $C1 = 10\mu\text{F}$, $C2 = C4 = 22\mu\text{F}$, $I_{OUT1} = 0\text{A to } 2\text{A}$, $I_{OUT2} = 0\text{A to } 1.7\text{A}$.

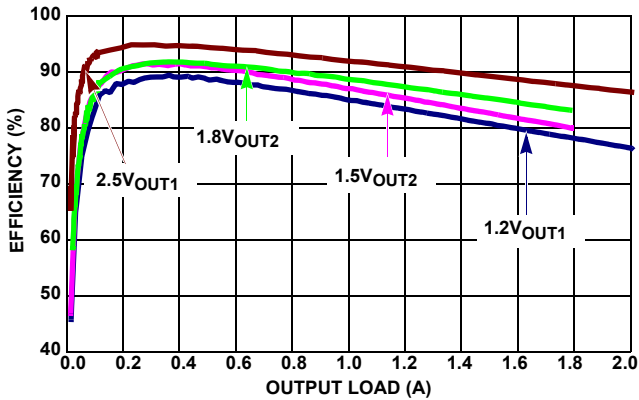

FIGURE 3. EFFICIENCY vs LOAD, 2.25MHz, 3.3VIN PWM

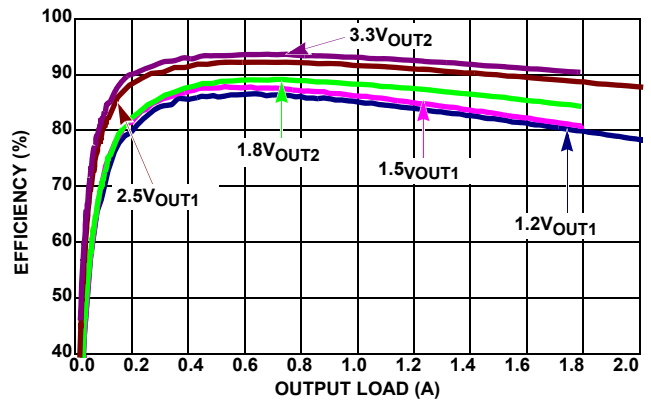

FIGURE 4. EFFICIENCY vs LOAD, 2.25MHz, 5VIN PWM

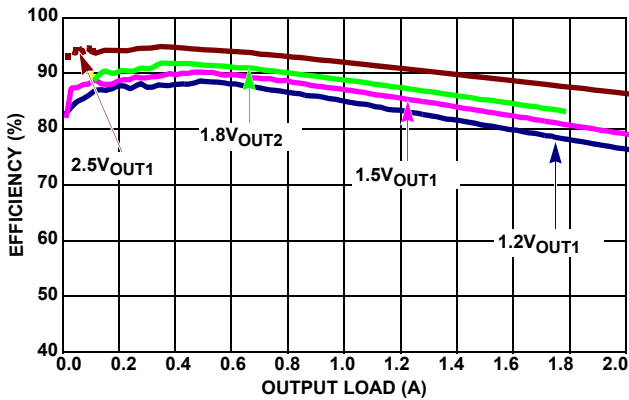

FIGURE 5. EFFICIENCY vs LOAD, 2.25MHz, 3.3VIN PFM

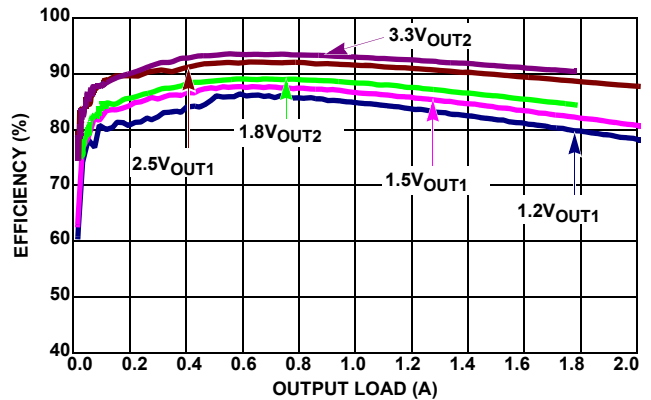

FIGURE 6. EFFICIENCY vs LOAD, 2.25MHz, 5VIN PFM

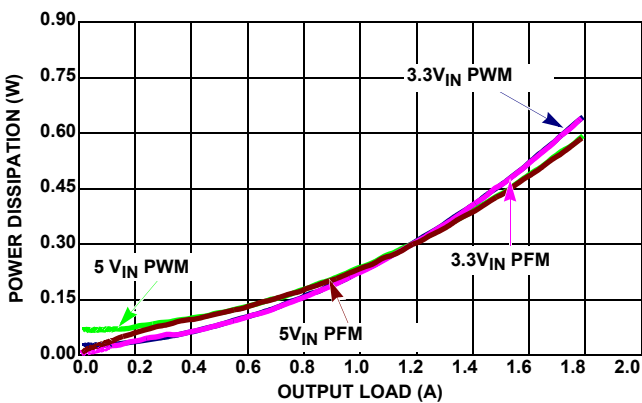

FIGURE 7. POWER DISSIPATION vs LOAD, 2.25MHz, 1.8V, CHANNEL 2

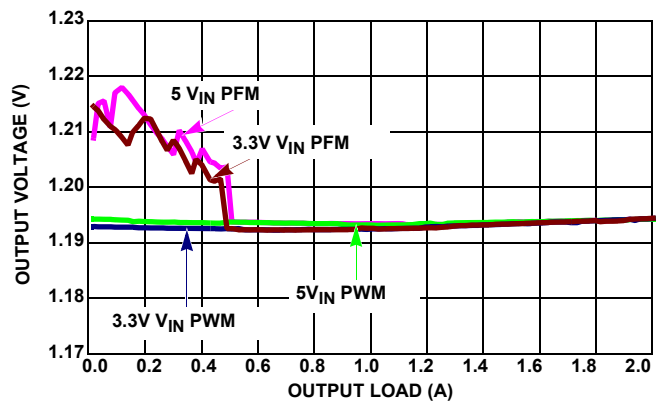

FIGURE 8. V_{OUT} REGULATION vs LOAD, 2.25MHz, 1.2V, CHANNEL1

Typical Operating Performance (Unless otherwise noted) operating conditions are:

$T_A = +25^\circ\text{C}$, $V_{IN} = 2.8\text{V to } 5.5\text{V}$, $EN = V_{IN}$, $L1 = L2 = 1.2\mu\text{H}$, $C1 = 10\mu\text{F}$, $C2 = C4 = 22\mu\text{F}$, $I_{OUT1} = 0\text{A to } 2\text{A}$, $I_{OUT2} = 0\text{A to } 1.7\text{A}$. **(Continued)**

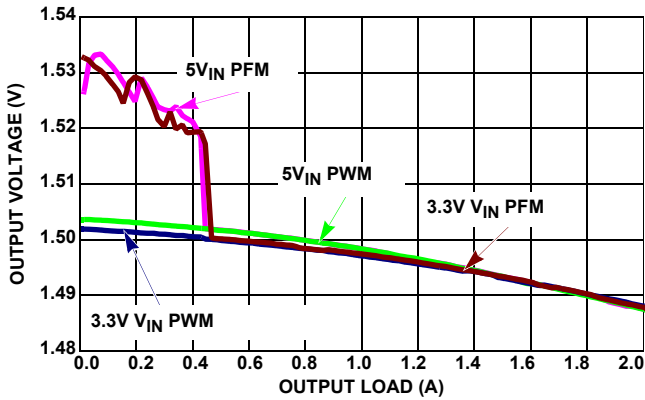

FIGURE 9. V_{OUT} REGULATION vs LOAD, 2.25MHz, 1.5V CHANNEL2

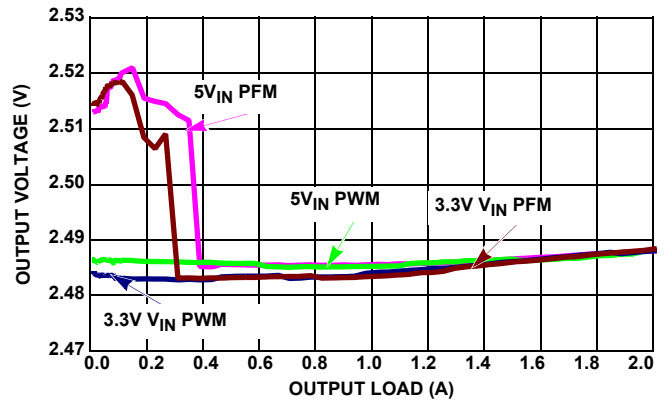

FIGURE 10. V_{OUT} REGULATION vs LOAD, 2.25MHz, 2.5V CHANNEL1

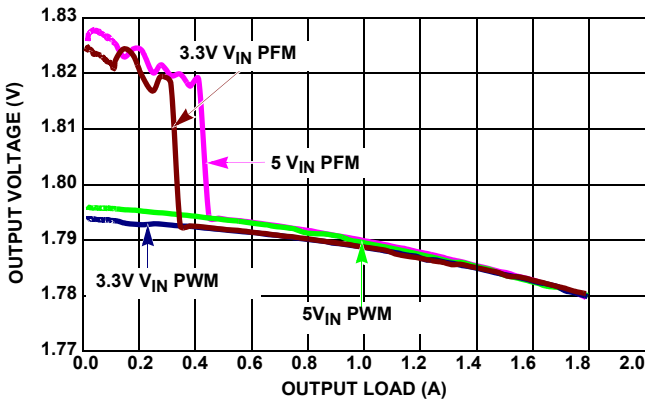

FIGURE 11. V_{OUT} REGULATION vs LOAD, 2.25MHz, 1.8V, CHANNEL 2

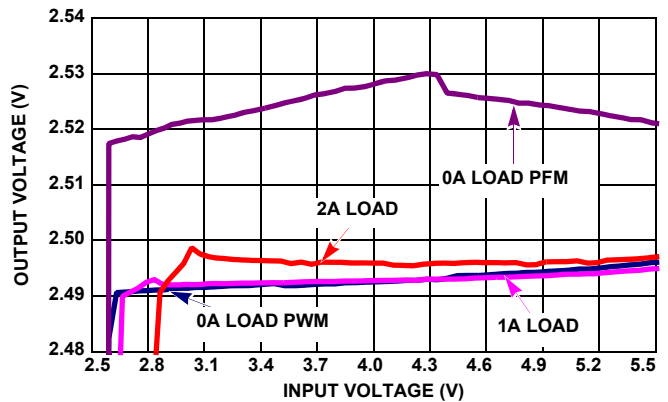

FIGURE 12. OUTPUT VOLTAGE REGULATION vs V_{IN} 2.5V CHANNEL 1

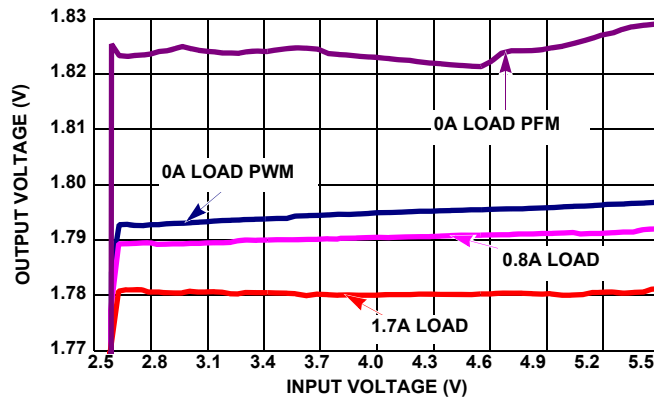

FIGURE 13. OUTPUT VOLTAGE REGULATION vs V_{IN} 1.8V CHANNEL 2

Typical Operating Performance (Unless otherwise noted) operating conditions are:

$T_A = +25^\circ\text{C}$, $V_{IN} = 2.8\text{V to } 5.5\text{V}$, $EN = V_{IN}$, $L1 = L2 = 1.2\mu\text{H}$, $C1 = 10\mu\text{F}$, $C2 = C4 = 22\mu\text{F}$, $I_{OUT1} = 0\text{A to } 2\text{A}$, $I_{OUT2} = 0\text{A to } 1.7\text{A}$. **(Continued)**

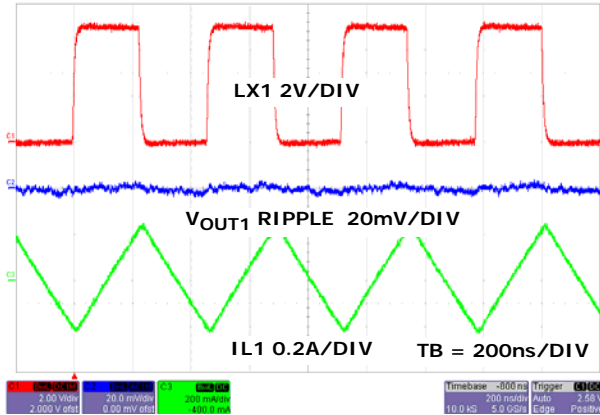

FIGURE 14. STEADY STATE OPERATION AT NO LOAD CHANNEL 1 (PWM)

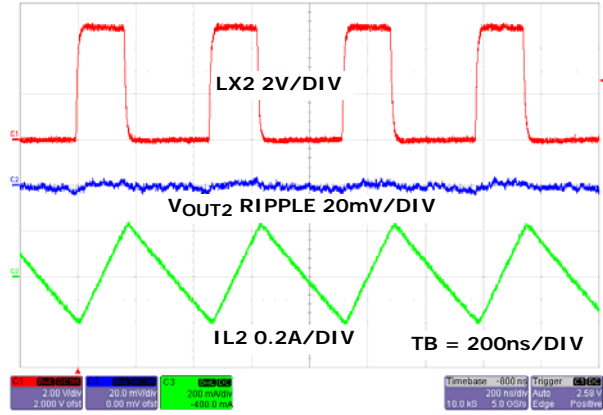

FIGURE 15. STEADY STATE OPERATION AT NO LOAD CHANNEL 2 (PWM)

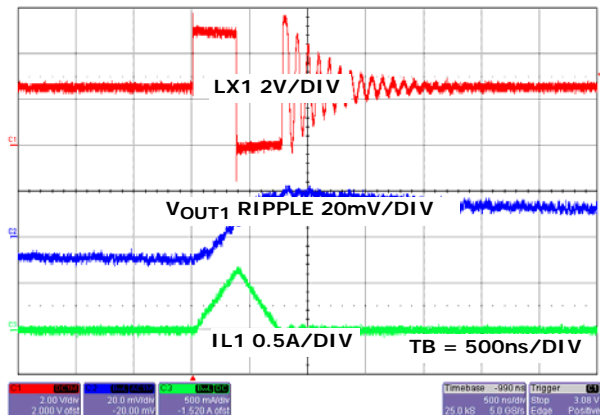

FIGURE 16. STEADY STATE OPERATION AT NO LOAD CHANNEL 1 (PFM)

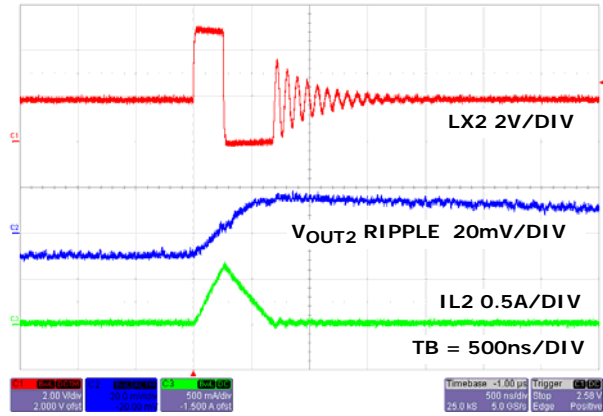

FIGURE 17. STEADY STATE OPERATION AT NO LOAD CHANNEL 2 (PFM)

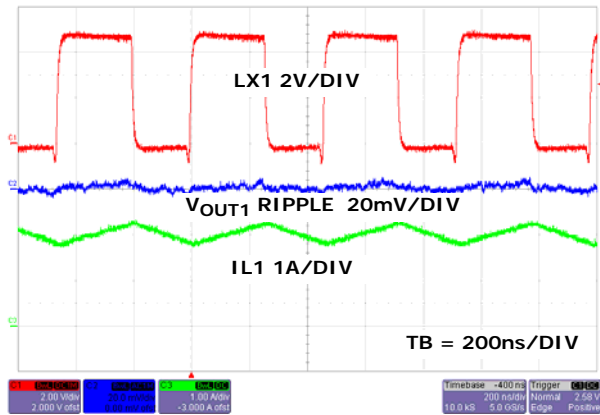

FIGURE 18. STEADY STATE OPERATION AT FULL LOAD CHANNEL 1

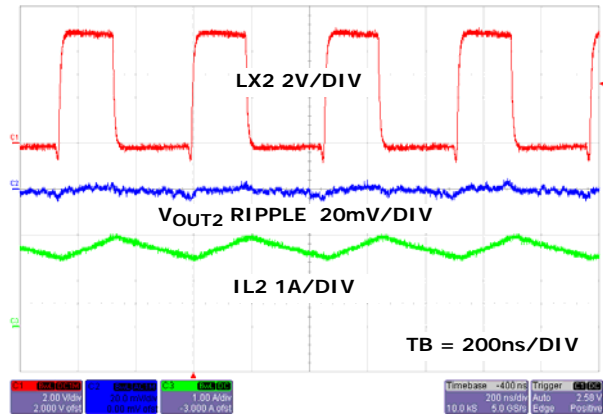

FIGURE 19. STEADY STATE OPERATION WITH FULL LOAD CHANNEL 2

Typical Operating Performance (Unless otherwise noted) operating conditions are:

$T_A = +25^\circ\text{C}$, $V_{IN} = 2.8\text{V}$ to 5.5V , $EN = V_{IN}$, $L1 = L2 = 1.2\mu\text{H}$, $C1 = 10\mu\text{F}$, $C2 = C4 = 22\mu\text{F}$, $I_{OUT1} = 0\text{A}$ to 2A , $I_{OUT2} = 0\text{A}$ to 1.7A . (Continued)

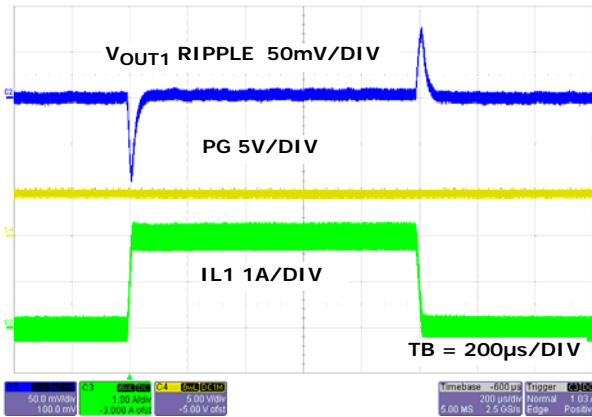

FIGURE 20. LOAD TRANSIENT CHANNEL 1 (PWM)

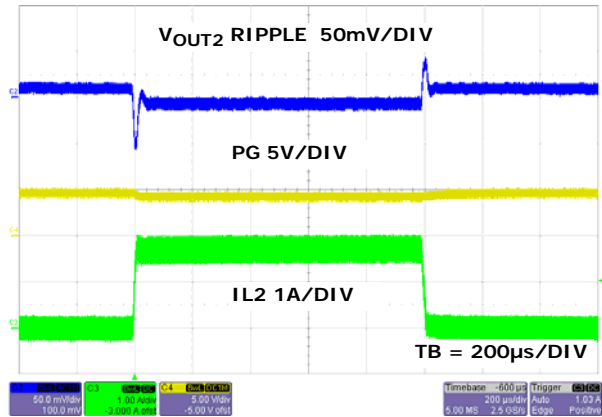

FIGURE 21. LOAD TRANSIENT CHANNEL 2 (PWM)

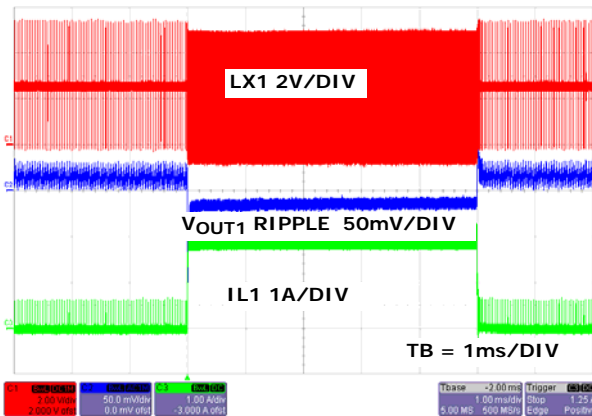

FIGURE 22. LOAD TRANSIENT CHANNEL 1 (PFM)

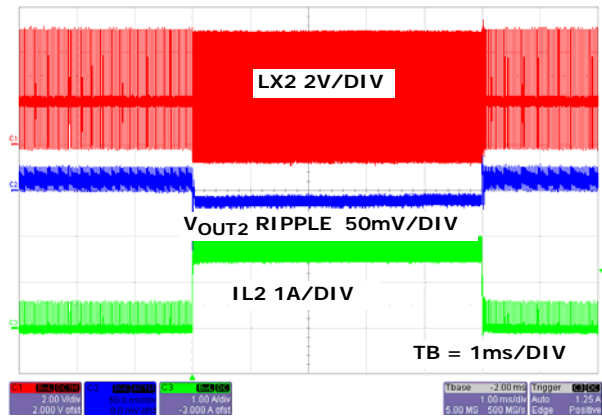

FIGURE 23. LOAD TRANSIENT CHANNEL 2 (PFM)

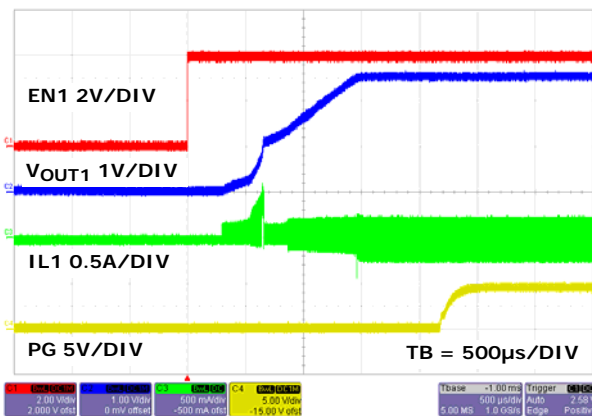

FIGURE 24. SOFT-START WITH NO LOAD CHANNEL 1 (PWM)

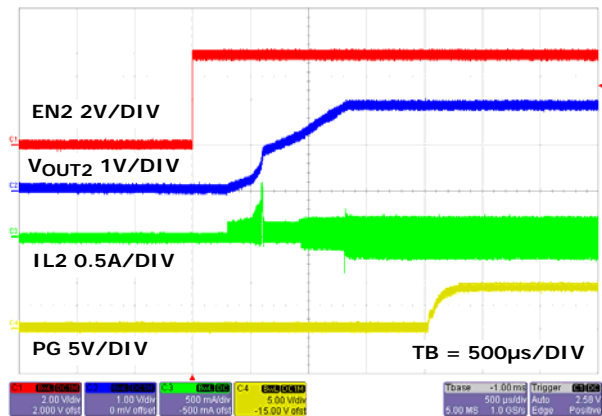

FIGURE 25. SOFT-START WITH NO LOAD CHANNEL 2 (PWM)

Typical Operating Performance (Unless otherwise noted) operating conditions are:

$T_A = +25^\circ\text{C}$, $V_{IN} = 2.8\text{V}$ to 5.5V , $EN = V_{IN}$, $L1 = L2 = 1.2\mu\text{H}$, $C1 = 10\mu\text{F}$, $C2 = C4 = 22\mu\text{F}$, $I_{OUT1} = 0\text{A}$ to 2A , $I_{OUT2} = 0\text{A}$ to 1.7A . (Continued)

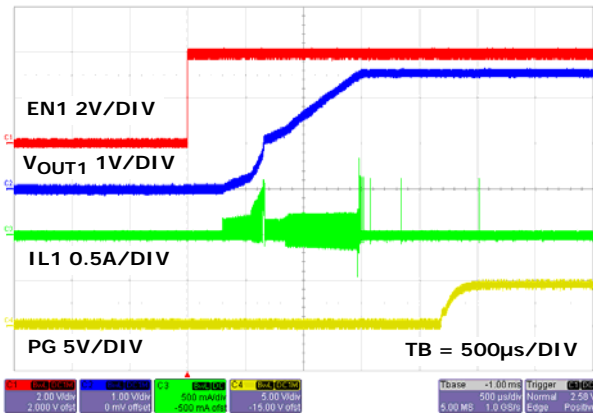

FIGURE 26. SOFT-START AT NO LOAD CHANNEL 1 (PFM)

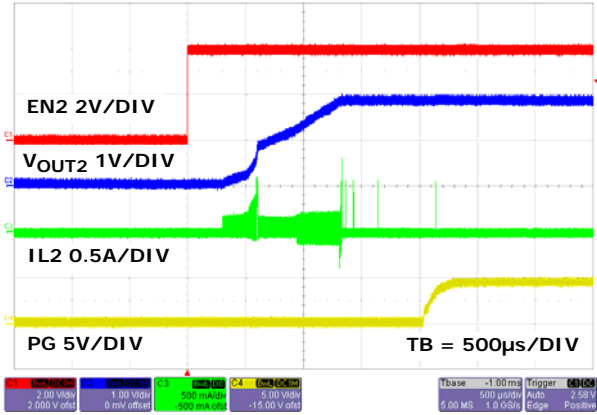

FIGURE 27. SOFT-START AT NO LOAD CHANNEL 2 (PFM)

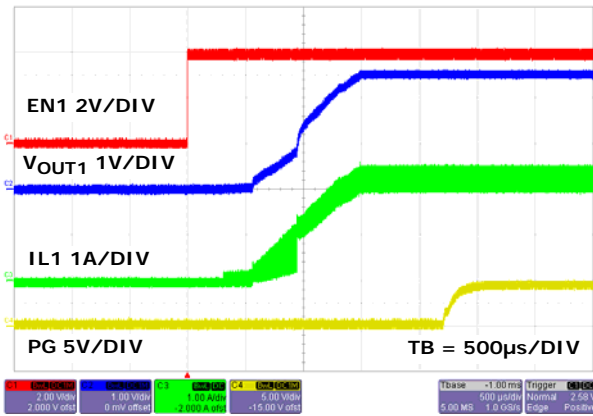

FIGURE 28. SOFT-START AT FULL LOAD CHANNEL 1

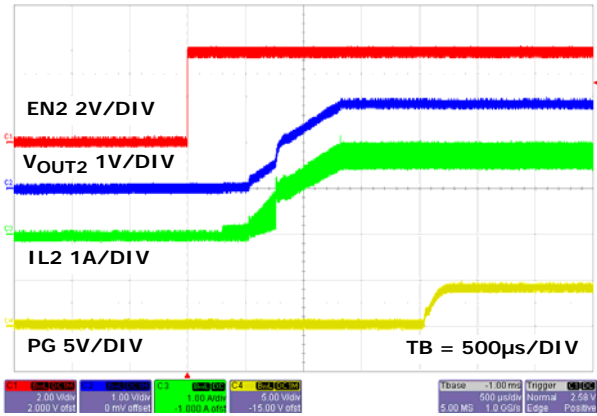

FIGURE 29. SOFT-START AT FULL LOAD CHANNEL 2

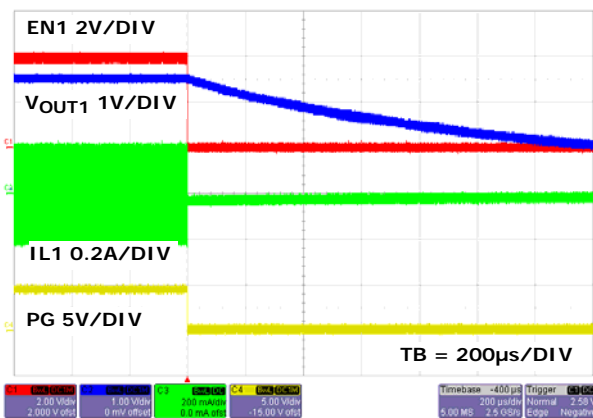

FIGURE 30. SOFT-DISCHARGE SHUTDOWN CHANNEL 1

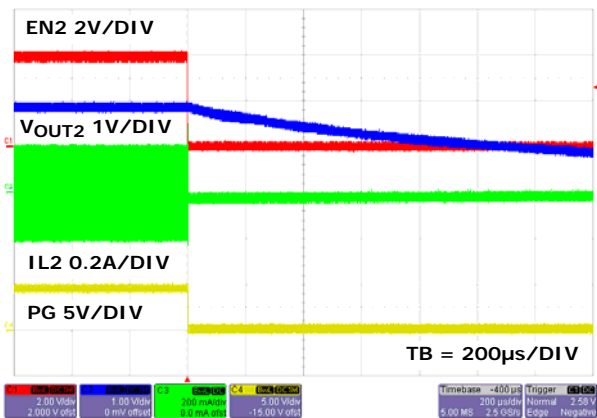

FIGURE 31. SOFT-DISCHARGE SHUTDOWN CHANNEL 2

Typical Operating Performance (Unless otherwise noted) operating conditions are:

$T_A = +25^\circ\text{C}$, $V_{IN} = 2.8\text{V}$ to 5.5V , $EN = V_{IN}$, $L1 = L2 = 1.2\mu\text{H}$, $C1 = 10\mu\text{F}$, $C2 = C4 = 22\mu\text{F}$, $I_{OUT1} = 0\text{A}$ to 2A , $I_{OUT2} = 0\text{A}$ to 1.7A . (Continued)

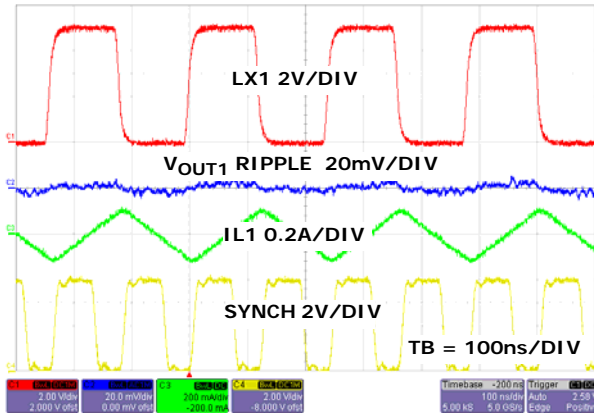

FIGURE 32. STEADY STATE OPERATION AT NO LOAD (PFM) WITH FREQUENCY = 8MHz CHANNEL 1

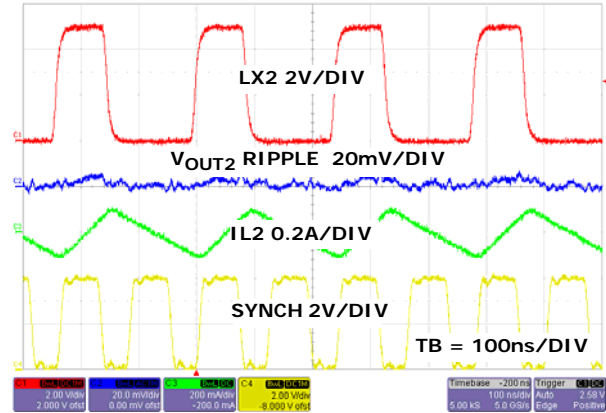

FIGURE 33. STEADY STATE OPERATION AT NO LOAD (PFM) WITH FREQUENCY = 8MHz CHANNEL 2

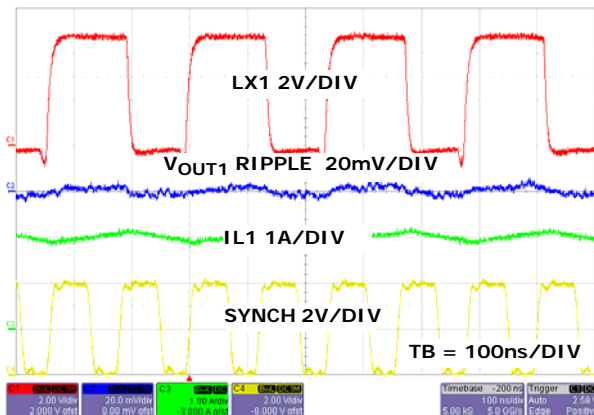

FIGURE 34. STEADY STATE OPERATION AT FULL LOAD (PFM) WITH FREQUENCY = 8MHz CHANNEL 1

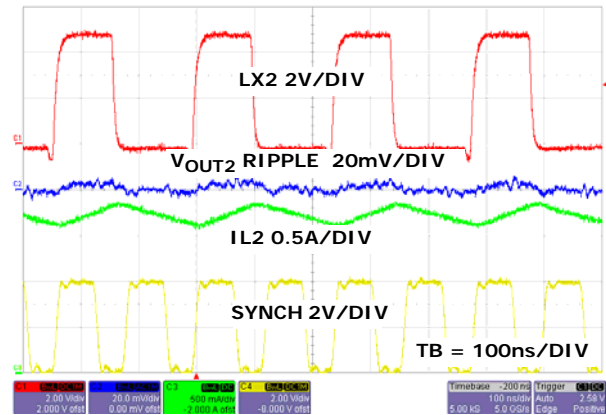

FIGURE 35. STEADY STATE OPERATION AT FULL LOAD (PFM) WITH FREQUENCY = 8MHz CHANNEL 2

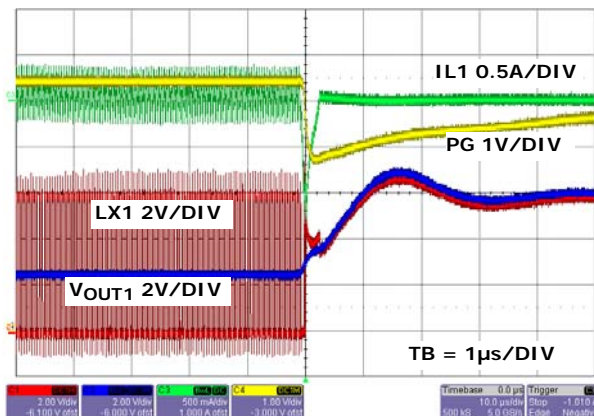

FIGURE 36. VOUT1 HARD SHORT TO VIN NEGATIVE CURRENT WAVEFORMS AT HIGH LINE CHANNEL 1

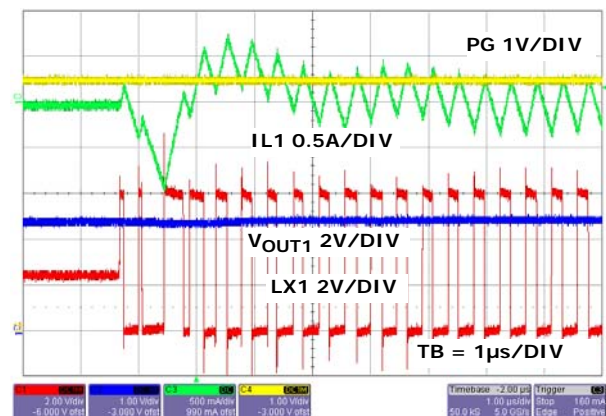

FIGURE 37. RECOVERY FROM HARD SHORT NEGATIVE CURRENT WAVEFORMS V_{OUT1} CHANNEL 1

Typical Operating Performance (Unless otherwise noted) operating conditions are:

$T_A = +25^\circ\text{C}$, $V_{IN} = 2.8\text{V to } 5.5\text{V}$, $EN = V_{IN}$, $L1 = L2 = 1.2\mu\text{H}$, $C1 = 10\mu\text{F}$, $C2 = C4 = 22\mu\text{F}$, $I_{OUT1} = 0\text{A to } 2\text{A}$, $I_{OUT2} = 0\text{A to } 1.7\text{A}$. **(Continued)**

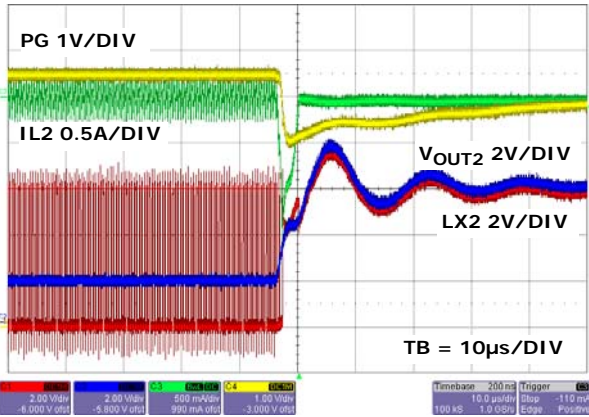

FIGURE 38. VOUT2 HARD SHORT TO VIN NEGATIVE CURRENT WAVEFORMS AT HIGH LINE CHANNEL 2

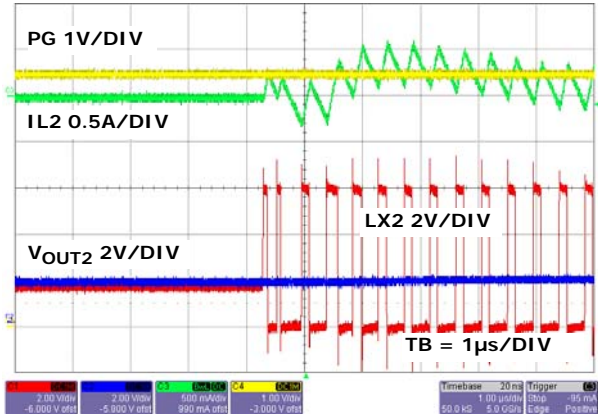

FIGURE 39. RECOVERY FROM HARD SHORT NEGATIVE CURRENT WAVEFORMS V_{OUT2} CHANNEL 2

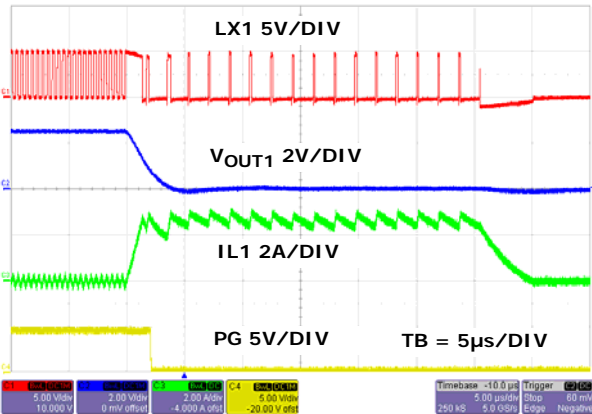

FIGURE 40. OUTPUT SHORT CIRCUIT CHANNEL 1

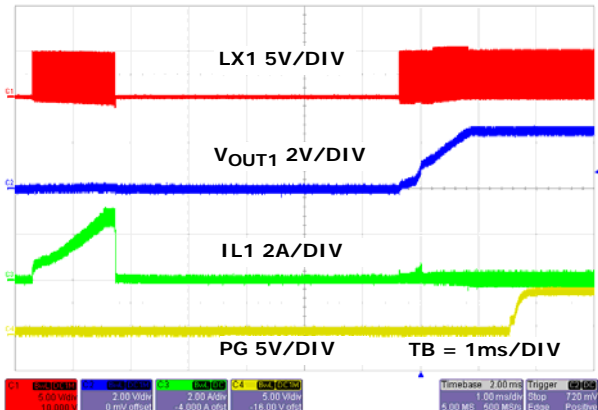

FIGURE 41. OUTPUT SHORT CIRCUIT RECOVERY CHANNEL 1

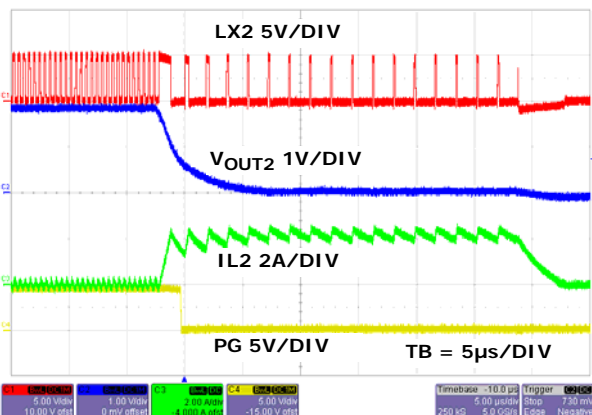

FIGURE 42. OUTPUT SHORT CIRCUIT CHANNEL 2

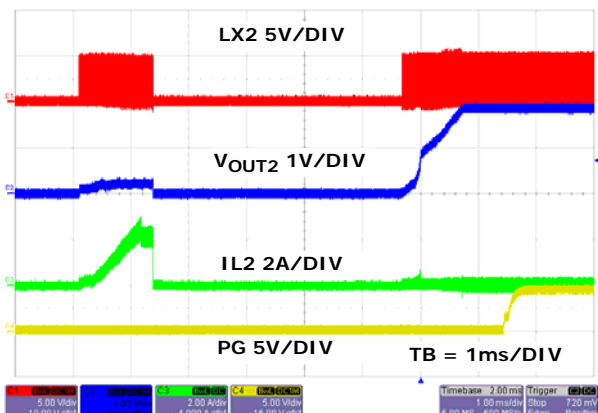

FIGURE 43. OUTPUT SHORT CIRCUIT RECOVERY CHANNEL 2

Theory of Operation

The ISL8022 is a dual 2A/1.7A step-down switching regulator optimized for battery-powered or mobile applications. The regulator operates at 2.25MHz fixed switching frequency under heavy load condition to allow small external inductor and capacitors to be used for minimal printed-circuit board (PCB) area. At light load, the regulator reduces the switching frequency, unless forced to the fixed frequency, to minimize the switching loss and to maximize the battery life. The two channels are 180° out-of-phase operation. The quiescent current when the outputs are not loaded is typically only 40µA. The supply current is typically only 6.5µA when the regulator is shut down.

PWM Control Scheme

Pulling the SYNC pin LOW (<0.4V) forces the converter into PWM mode in the next switching cycle regardless of output current. Each of the channels of the ISL8022 employs the current-mode pulse-width modulation (PWM) control scheme for fast transient response and pulse-by-pulse current limiting shown in the “Block Diagram” on page 3. The current loop consists of the oscillator, the PWM comparator COMP, current sensing circuit, and the slope compensation for the current loop stability. The current sensing circuit consists of the resistance of the P-channel MOSFET when it is turned on and the current sense amplifier CSA1 (or CSA2 on Channel 2). The gain for the current sensing circuit is typically 0.32V/A. The control reference for the current loops comes from the error amplifier EAMP of the voltage loop.

The PWM operation is initialized by the clock from the oscillator. The P-channel MOSFET is turned on at the beginning of a PWM cycle and the current in the MOSFET starts to ramp up. When the sum of the current amplifier CSA1 (or CSA2) and the compensation slope ($0.9V/\mu s$) reaches the control reference of the current loop, the PWM comparator COMP sends a signal to the PWM logic to turn off the P-MOSFET and to turn on the N-channel MOSFET. The N-MOSFET stays on until the end of the PWM cycle. Figure 44 shows the typical operating waveforms during the PWM operation. The dotted lines illustrate the sum of the compensation ramp and the current-sense amplifier CSA_ output.

The output voltage is regulated by controlling the reference voltage to the current loop. The bandgap circuit outputs a 0.6V reference voltage to the voltage control loop. The feedback signal comes from the V_{FB} pin. The soft-start block only affects the operation during the start-up and will be discussed separately shortly. The error amplifier is a transconductance amplifier that converts the voltage error signal to a current output. The voltage loop is internally compensated with the 27pF and 250kΩ RC network. The maximum EAMP voltage output is precisely clamped to 1.8V.

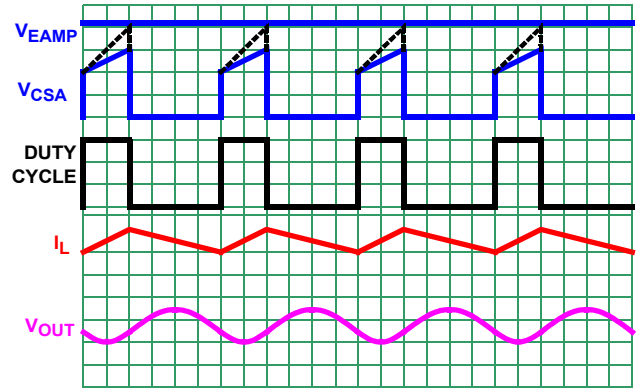

FIGURE 44. PWM OPERATION WAVEFORMS

SKIP Mode

Pulling the SYNC pin HIGH (>1.5V) enable the converter into PFM mode at low load. The ISL8022 enters a pulse-skipping mode at light load to minimize the switching loss by reducing the switching frequency. Figure 45 illustrates the skip-mode operation. A zero-cross sensing circuit shown in block diagram monitors the N-MOSFET current for zero crossing. When 16 consecutive cycles of the N-MOSFET crossing zero are detected, the regulator enters the skip mode. During the 16 detecting cycles, the current in the inductor is allowed to become negative. The counter is reset to zero when the current in any cycle does not cross zero.

Once the skip mode is entered, the pulse modulation starts being controlled by the SKIP comparator shown in the “Block Diagram” on page 3. Each pulse cycle is still synchronized by the PWM clock. The P-MOSFET is turned on at the clock and turned off when its current reaches the threshold of 600mA. As the average inductor current in each cycle is higher than the average current of the load, the output voltage rises cycle over cycle. When the output voltage reaches 1.5% above the nominal voltage, the P-MOSFET is turned off immediately. Then the inductor current is fully discharged to zero and stays at zero. The output voltage reduces gradually due to the load current discharging the output capacitor. When the output voltage drops to the nominal voltage, the P-MOSFET will be turned on again at the clock, repeating the previous operations.

The regulator resumes normal PWM mode operation when the output voltage drops 1.5% below the nominal voltage.

Synchronization Control

The frequency of operation can be synchronized up to 8MHz by an external signal applied to the SYNC pin. The 1st falling edge on the SYNC triggered the rising edge of the PWM ON pulse of Channel 1. The 2nd falling edge of the SYNC triggers the rising edge of the PWM ON pulse of the Channel 2. This process alternates indefinitely allowing 180° output phase operation between the two channels. The internal frequency will take control when the divided external sync is lower than 2.25MHz. The falling edge on the SYNC triggers the rising edge of the PWM ON pulse.

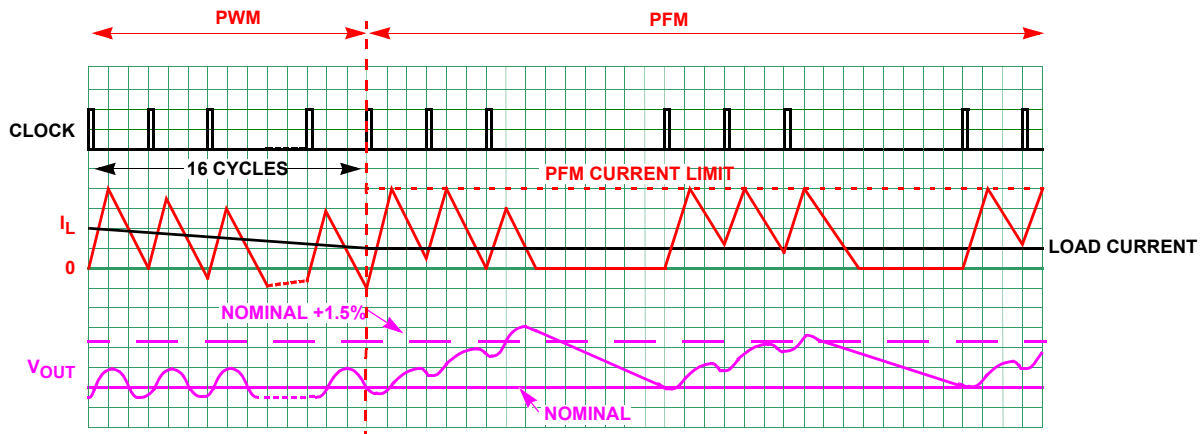

FIGURE 45. SKIP MODE OPERATION WAVEFORMS

Positive and Negative Overcurrent Protection

CSA1 and CSA2 are used to monitor output 1 and output 2 channels respectively. The overcurrent protection is realized by monitoring the CSA_ output with the OCP threshold logic, as shown in the “Block Diagram” on page 3. The current sensing circuit has a gain of 0.32V/A, from the P-MOSFET current to the CSA_ output. When the CSA_ output reaches the threshold of 1.25V for Channel 1 and 1.1V for Channel 2, the OCP comparator is tripped to turn off the P-MOSFET immediately. The overcurrent function protects the switching converter from a shorted output by monitoring the current flowing through the upper MOSFETs.

Upon detection of an overcurrent condition, the upper MOSFET will be immediately turned off and will not be turned on again until the next switching cycle. Upon detection of the initial overcurrent condition, the Overcurrent Fault Counter is set to 1 and the Overcurrent Condition Flag is set from LOW to HIGH. If, on the subsequent cycle, another overcurrent condition is detected, the OC Fault Counter will be incremented. If there are seventeen sequential OC fault detections, the regulator will be shut down under an Overcurrent Fault Condition. An Overcurrent Fault Condition will result with the regulator attempting to restart in a hiccup mode with the delay between restarts being 4 soft-start periods. At the end of the fourth soft-start wait period, the fault counters are reset and soft-start is attempted again. If the overcurrent condition goes away prior to the OC Fault Counter reaching a count of four, the Overcurrent Condition Flag will set back to LOW.

In the event that the inductor current reaches -1.6A, the part enters Negative Overcurrent Protection. At this point, all switching stops and the part enters tri-state mode while the pull-down FET is discharging the output until it reaches normal regulation voltage, then the IC restarts switching.

PG

The power-good signal (PG), monitors both of the output channels. When powering up, the open-collector Power-On-Reset output holds low for about 1ms after V_{O1} and V_{O2} reaches the preset voltages. The PG output also serves as a 1ms delayed power-good signal. If one of the outputs is disabled, then PG only monitors the active channels. There is an internal 1M Ω pull-up resistor.

UVLO

When the input voltage is below the undervoltage lock-out (UVLO) threshold, the regulator is disabled.

Enable

The enable (EN1, EN2) input allows the user to control the turning on or off the regulator for purposes such as power-up sequencing. The regulator is enabled, there is typically a 600 μ s delay for waking up the bandgap reference and the soft start-up begins.

Soft Start-Up

The soft start-up eliminates the in-rush current during the start-up. The soft-start block outputs a ramp reference to both the voltage loop and the current loop. The two ramps limit the inductor current rising speed as well as the output voltage speed so that the output voltage rises in a controlled fashion. At the very beginning of the start-up, the feedback voltage is less than 0.2V; hence the PWM operating frequency is 1/3 of the normal frequency. In forced PWM mode, the IC will continue to start-up in PFM mode to support pre-biased load applications.

Discharge Mode (Soft-Stop)

When a transition to shutdown mode occurs, or the output undervoltage fault latch is set, the outputs discharge to GND through an internal 100 Ω switch.

Power MOSFETs

The power MOSFETs are optimized for best efficiency. The ON-resistance for the P-MOSFET is typically 100m Ω and the ON-resistance for the N-MOSFET is typical 90m Ω .

100% Duty Cycle

The ISL8022 features 100% duty cycle operation to maximize the battery life. When the battery voltage drops to a level that the ISL8022 can no longer maintain the regulation at the output, the regulator completely turns on the P-MOSFET. The maximum dropout voltage under the 100% duty-cycle operation is the product of the load current and the ON-resistance of the P-MOSFET.

Thermal Shutdown

The ISL8022 has built-in thermal protection. When the internal temperature reaches +150 °C, the regulator is completely shut down. As the temperature drops to +130 °C, the ISL8022 resumes operation by stepping through a soft start-up.

Applications Information

Output Inductor and Capacitor Selection

To consider steady state and transient operation, ISL8022 typically uses a 1.2µH output inductor. Higher or lower inductor value can be used to optimize the total converter system performance. For example, for higher output voltage 3.3V application, in order to decrease the inductor current ripple and output voltage ripple, the output inductor value can be increased. The inductor ripple current can be expressed as in Equation 1:

$$\Delta I = \frac{V_O \cdot \left(1 - \frac{V_O}{V_{IN}}\right)}{L \cdot f_S} \quad (\text{EQ. 1})$$

The inductor's saturation current rating needs to be at least larger than the peak current. The ISL8022 protects the typical peak current 3.2A/2.8A. The saturation current needs to be over 3.6A for maximum output current application.

ISL8022 uses internal compensation network and the output capacitor value is dependent on the output voltage. The ceramic capacitor is recommended to be X5R or X7R. The recommended minimum output capacitor values are shown in Table 1 for the ISL8022 on page 2.

Output Voltage Selection

The output voltage of the regulator can be programmed via an external resistor divider that is used to scale the output voltage relative to the internal reference voltage and feed it back to the inverting input of the error amplifier. Refer to "Typical Applications" on page 2 Figure 2.

The output voltage programming resistor, R_2 (or R_5 in Channel 2), will depend on the desired output voltage of the regulator. The value for the feedback resistor is typically between 0Ω and 750kΩ.

Let $R_3 = 100\text{k}\Omega$, then R_2 will be as shown in Equation 2:

$$R_2 = R_3 \left(\frac{V_{OUT}}{V_{FB}} - 1 \right) \quad (\text{EQ. 2})$$

If the output voltage desired is 0.6V, then R_3 is left unpopulated and short R_2 . For better performance, add 10pF in parallel to R_2 .

Input Capacitor Selection

The main functions for the input capacitor is to provide decoupling of the parasitic inductance and to provide filtering function to prevent the switching current flowing back to the battery rail. One 10µF X5R or X7R ceramic capacitor is a good starting point for the input capacitor selection per channel. An optional input inductor can be used before the ceramic capacitor to limit switching noise. It is recommended to limit the inductance less than 0.15µH.

PCB Layout Recommendation

The PCB layout is a very important converter design step to make sure the designed converter works well. Refer to ISL8022 design procedure for suggestions. For ISL8022, the power loop is composed of the output inductor L's, the output capacitor C_{OUT1} and C_{OUT2} , the LX's pins, and the GND pin. It is necessary to make the power loop as small as possible and the connecting traces among them should be direct, short and wide. The switching node of the converter, the LX_ pins, and the traces connected to the node are very noisy, so keep the voltage feedback trace away from these noisy traces. The input capacitor should be placed to VIN pin as close as possible and the ground of input and output capacitors should be connected as close as possible. The heat of the IC is mainly dissipated through the thermal pad. Maximizing the copper area connected to the thermal pad is preferable. In addition, a solid ground plane is helpful for better EMI performance. It is recommended to add at least 5 vias ground connection within the pad for the best thermal relief.

Revision History

The revision history provided is for informational purposes only and is believed to be accurate, but not warranted. Please go to web to make sure you have the latest Rev.

DATE	REVISION	CHANGE
March 11, 2013	FN7650.3	Table 1 on page 2, changed L1, L2 for 1.8V and 2.5V output from 1.5 μ h-3.3 μ h to 1.2 μ h-3.3 μ h.
April 7, 2011	FN7650.2	Converted to New Intersil Template Added second bullet to "Related Literature" on page 1 Replaced copyright at the bottom of page 1 per legal In "Electrical Specifications" table: <ul style="list-style-type: none"> - Changed typ for "Soft-Start Ramp Time Cycle" on page 5 from 2ms to 1.3ms - In "Output Voltage Accuracy" on page 5, removed reference to Note 7 - Changed typ for "Delay Time (Rising Edge)" on page 6 from 1ms to 0.76ms - Changed typ for "Internal PGOOD Delay Time (Falling Edge)" on page 6 from 1μs to 2μs - In "Synchronization Range" on page 6, changed Note 8 reference to Note 7 - Removed Note 8 "Limits established by characterization and are not production tested." In "Soft Start-Up" on page 15, changed "...beginning of the start-up, the output voltage is less than 0.2V." to "...beginning of the start-up, the feedback voltage is less than 0.2V."
July 26, 2010	FN7650.1	Updated "Package Outline Drawing" on page 18. Edits were: Added land pattern Removed table and added dimensions to drawing, per new POD standards. Changed Note 4 from "Dimension b applies.." to "Dimension applies.."
June 9, 2010	FN7650.0	Initial Release.

About Intersil

Intersil Corporation is a leader in the design and manufacture of high-performance analog, mixed-signal and power management semiconductors. The company's products address some of the fastest growing markets within the industrial and infrastructure, personal computing and high-end consumer markets. For more information about Intersil or to find out how to become a member of our winning team, visit our website and career page at www.intersil.com.

For a complete listing of Applications, Related Documentation and Related Parts, please see the respective product information page. Also, please check the product information page to ensure that you have the most updated datasheet: [ISL8022](http://www.intersil.com)

To report errors or suggestions for this datasheet, please go to: www.intersil.com/askourstaff

Reliability reports are available from our website at: <http://rel.intersil.com/reports/search.php>

© Copyright Intersil Americas LLC 2010-2013. All Rights Reserved.
All trademarks and registered trademarks are the property of their respective owners.

For additional products, see www.intersil.com/en/products.html

Intersil products are manufactured, assembled and tested utilizing ISO9001 quality systems as noted in the quality certifications found at www.intersil.com/en/support/qualandreliability.html

Intersil products are sold by description only. Intersil may modify the circuit design and/or specifications of products at any time without notice, provided that such modification does not, in Intersil's sole judgment, affect the form, fit or function of the product. Accordingly, the reader is cautioned to verify that datasheets are current before placing orders. Information furnished by Intersil is believed to be accurate and reliable. However, no responsibility is assumed by Intersil or its subsidiaries for its use; nor for any infringements of patents or other rights of third parties which may result from its use. No license is granted by implication or otherwise under any patent or patent rights of Intersil or its subsidiaries.

For information regarding Intersil Corporation and its products, see www.intersil.com

Package Outline Drawing

L12.4x3

12 LEAD DUAL FLAT NO-LEAD PLASTIC PACKAGE

Rev 2, 7/10

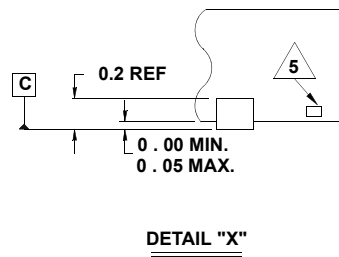
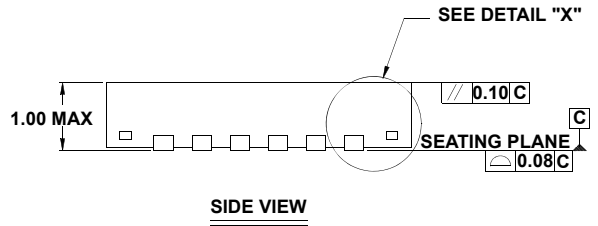
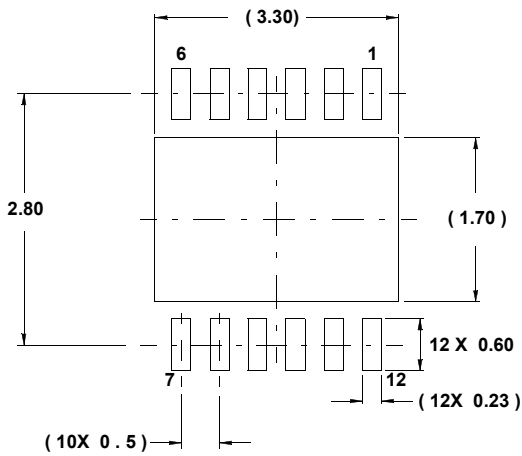
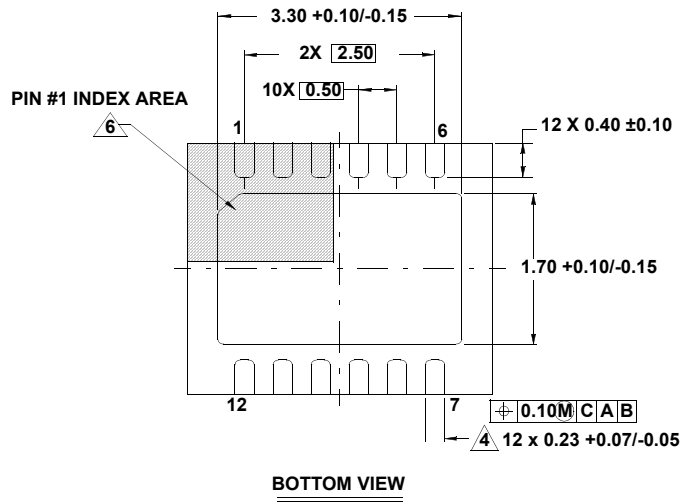
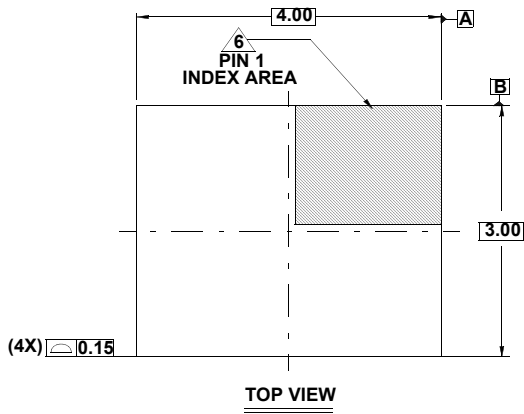

NOTES:

1. Dimensions are in millimeters.
Dimensions in () for Reference Only.
2. Dimensioning and tolerancing conform to AMSE Y14.5m-1994.
3. Unless otherwise specified, tolerance : Decimal ± 0.05
4. Dimension applies to the metallized terminal and is measured between 0.15mm and 0.30mm from the terminal tip.
5. Tiebar shown (if present) is a non-functional feature.
6. The configuration of the pin #1 identifier is optional, but must be located within the zone indicated. The pin #1 identifier may be either a mold or mark feature.
7. Compliant to JEDEC MO-229 V4030D-4 issue E.