

ISL59111

8MHz Rail-to-Rail Composite Video Driver

FN6172
Rev 4.00
April 19, 2007

The ISL59111 is a single rail-to-rail 3-pole output reconstruction filter with a -3dB roll-off frequency of 8MHz and a slew rate of 40V/μs, with input signal DC restoration accomplished with an internal sync tip clamp. Operating from single supplies ranging from +2.5V to +3.6V and sinking an ultra-low 2mA quiescent current, the ISL59111 is ideally suited for low power, battery-operated applications. It also features inputs capable of reaching down to 0.15V below the negative rail. Additionally, an enable high pin shuts the part down in under 14ns.

The ISL59111 is designed to meet the needs for very low power and bandwidth required in battery-operated communication, instrumentation, and modern industrial applications such as video on demand, cable set-top boxes, DVD players, and HDTV. The ISL59111 is offered in a space-saving CSP package guaranteed to a 0.7mm maximum height constraint and specified for operation from -40°C to +85°C temperature range.

Ordering Information

PART NUMBER (See Note)	PART MARKING	TAPE & REEL	PACKAGE (Pb-Free)	PKG. DWG. #
ISL59111IZ-T7	111Z	7" (3k pcs)	6 Ld CSP (2x3)	MDP0054

NOTE: Intersil Pb-free plus anneal products employ special Pb-free material sets; molding compounds/die attach materials and 100% matte tin plate termination finish, which are RoHS compliant and compatible with both SnPb and Pb-free soldering operations. Intersil Pb-free products are MSL classified at Pb-free peak reflow temperatures that meet or exceed the Pb-free requirements of IPC/JEDEC J STD-020.

Features

- 3rd order 8MHz reconstruction filter
- 40V/μs slew rate
- Low supply current = 2mA
- Power-down current less than 3μA
- Supplies from 2.5V to 3.6V
- Rail-to-rail output
- Input to 0.15V below V_{S-}
- Input sync tip clamp
- SAG correction reduces AC coupling capacitor size
- Pb-free plus anneal available (RoHS compliant)

Applications

- Video amplifiers
- Portable and handheld products
- Communications devices
- Video on demand
- Cable set-top boxes
- Satellite set-top boxes
- DVD players
- HDTV
- Personal video recorders

Pinout

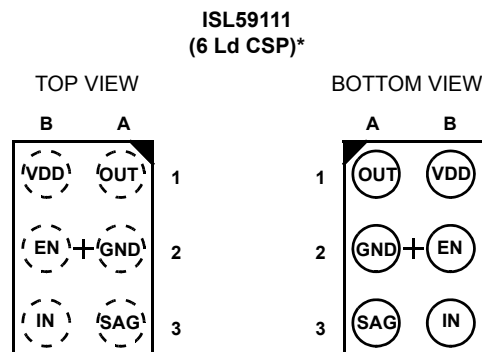

*0.7mm MAXIMUM HEIGHT GUARANTEED

Absolute Maximum Ratings ($T_A = +25^\circ\text{C}$)

Supply Voltage from V_{S+} to GND 3.6V
 Input Voltage $V_{S+} + 0.3\text{V}$ to GND -0.3V
 Continuous Output Current 40mA
 Power Dissipation See Curves

Storage Temperature -65°C to $+125^\circ\text{C}$
 Ambient Operating Temperature -40°C to $+85^\circ\text{C}$
 Operating Junction Temperature $+125^\circ\text{C}$
 Pb-free reflow profile see link below
<http://www.intersil.com/pbfree/Pb-FreeReflow.asp>

CAUTION: Stresses above those listed in "Absolute Maximum Ratings" may cause permanent damage to the device. This is a stress only rating and operation of the device at these or any other conditions above those indicated in the operational sections of this specification is not implied.

IMPORTANT NOTE: All parameters having Min/Max specifications are guaranteed. Typ values are for information purposes only. Unless otherwise noted, all tests are at the specified temperature and are pulsed tests, therefore: $T_J = T_C = T_A$

Electrical Specifications $V_{S+} = 3.3\text{V}$, $T_A = +25^\circ\text{C}$, $R_L = 150\Omega$ to GND, $C_L = 0.1\mu\text{F}$, unless otherwise specified.

DESCRIPTION	PARAMETER	CONDITIONS	MIN	TYP	MAX	UNIT
INPUT CHARACTERISTICS						
V_{CC}	Supply Voltage Range		2.5		3.6	V
I_{DD-ON}	Quiescent Supply Current	$V_{IN} = 500\text{mV}$, $EN = V_{DD}$, no load		2	2.75	mA
I_{DD-OFF}	Shutdown Supply Current	$EN = 0\text{V}$			3	μA
V_{OLS}	Output Level Shift Voltage	$V_{IN} = 0\text{V}$, no load	60	130	200	mV
V_{CLAMP}	Input Voltage Clamp	$I_{IN} = -1\text{mA}$	-40	-15	+10	mV
I_{CLAMP_CHG}	Clamp Charge Current	$V_{IN} = V_{CLAMP} - 100\text{mV}$		-6	-3	mA
I_{CLAMP_DCHG}	Clamp Discharge Current	$V_{IN} = 500\text{mV}$	2.5	5	7.5	μA
R_{IN}	Input Resistance	$0.5\text{V} < V_{IN} < 1.0\text{V}$	0.5	3		$\text{M}\Omega$
A_V	Voltage Gain	$R_L = 150\Omega$	1.95	2.0	2.04	V/V
A_{SAG}	SAG Correction DC Gain to V_{OUT}	SAG open		2.25		V/V
PSRR	DC Power Supply Rejection	$V_{DD} = 2.7\text{V}$ to 3.3V	43	63		dB
V_{OH}	Output Voltage High Swing	$V_{IN} = 2\text{V}$, $R_L = 150\Omega$ to GND	2.85	3.2		V
I_{SC}	Output Short-Circuit Current	$V_{IN} = 2\text{V}$, to GND through 10Ω		-94	-65	mA
		$V_{IN} = 100\text{mV}$, out short to V_{DD} through 10Ω	65	115		mA
I_{ENABLE}	Enable Current	$\pm 3.3\text{V}$, enable pin = 0V	-3	0	+3	μA
V_{IL}	Disable Threshold	$V_{DD} = 2.7\text{V}$ to 3.3V			0.8	V
V_{IH}	Enable Threshold	$V_{DD} = 2.7\text{V}$ to 3.3V	1.6			V
R_{OUT}	Shutdown Output Impedance	$EN = 0\text{V DC}$	3.6	4.5	5.9	$\text{k}\Omega$
		$EN = 0\text{V}$, $f = 4.5\text{MHz}$		3.4		$\text{k}\Omega$
AC PERFORMANCE						
BW	$\pm 0.1\text{dB}$ Bandwidth	$R_L = 150\Omega$, $C_L = 5\text{pF}$		4		MHz
BW	-3dB Bandwidth	$R_L = 150\Omega$, $C_L = 5\text{pF}$		8		MHz
	Normalized Stopband Gain	$f = 27\text{MHz}$		-24.2		dB
dG	Differential Gain	NTSC and PAL DC coupled		0.10		%
		NTSC and PAL AC coupled		0.84		%
dP	Differential Phase	NTSC and PAL DC coupled		0.05		$^\circ$
		NTSC and PAL AC coupled		0.62		$^\circ$
D/DT	Group Delay Variation	$f = 100\text{kHz}$, 5MHz		5.4		ns
SNR	Signal To Noise Ratio	100% white signal		65		dB

Electrical Specifications $V_S = 3.3V$, $T_A = +25^\circ C$, $R_L = 150\Omega$ to GND, $C_L = 0.1\mu F$, unless otherwise specified. (Continued)

DESCRIPTION	PARAMETER	CONDITIONS	MIN	TYP	MAX	UNIT
T_{ON}	Enable Time	$V_{IN} = 500mV$, V_{OUT} to 1%		200		ns
T_{OFF}	Disable Time	$V_{IN} = 500mV$, V_{OUT} to 1%		14		ns
+SR	Positive Slew Rate	10% to 90%, $V_{IN} = 1V$ step	20	41	70	V/ μs
-SR	Negative Slew Rate	90% to 10%, $V_{IN} = 1V$ step	-15	-30	-70	V/ μs
t_F	Fall Time	$2.5V_{STEP}$, 80% - 20%		25		ns
t_R	Rise Time	$2.5V_{STEP}$, 20% - 80%		22		ns

Typical Performance Curves

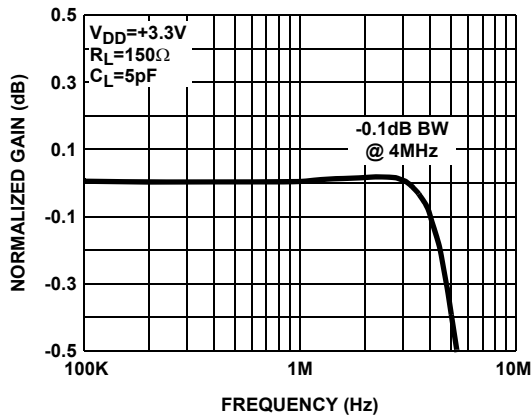

FIGURE 1. GAIN vs FREQUENCY -0.1dB

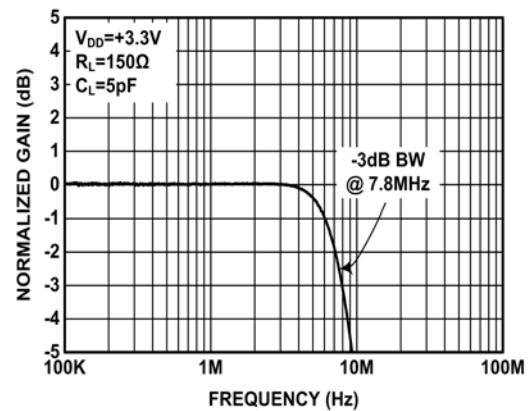

FIGURE 2. GAIN vs FREQUENCY -3dB POINT

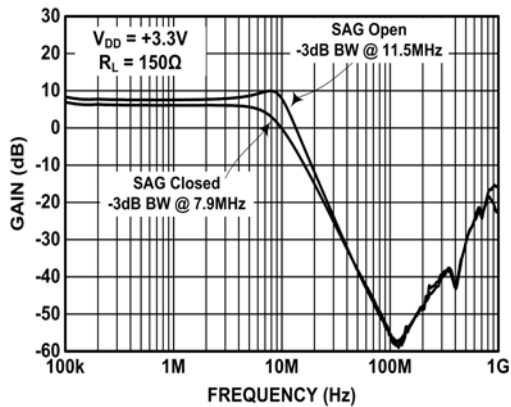

FIGURE 3. GAIN vs FREQUENCY -3dB

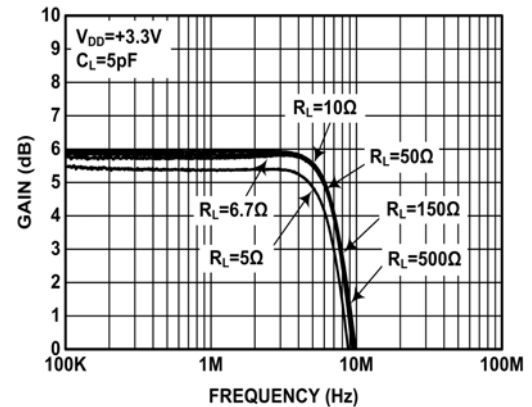

FIGURE 4. GAIN vs FREQUENCY FOR VARIOUS R_{LOAD}

Typical Performance Curves

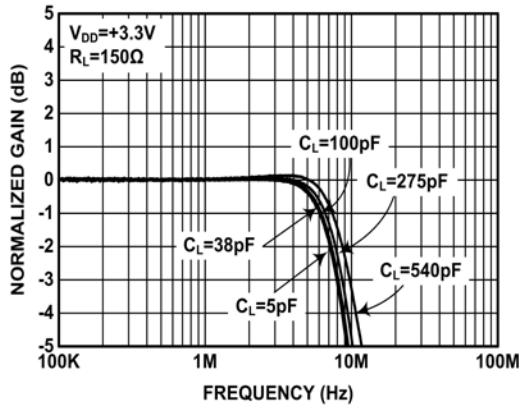

FIGURE 5. GAIN vs FREQUENCY FOR VARIOUS C_{LOAD}

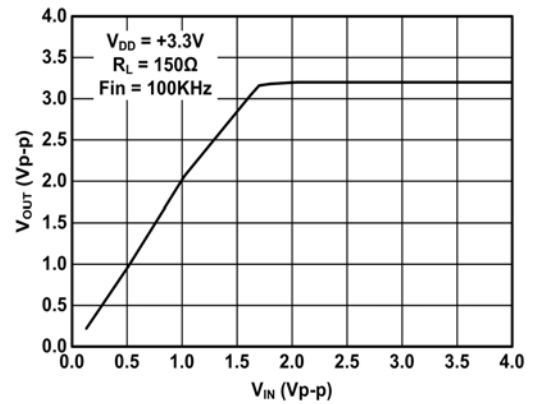

FIGURE 6. MAXIMUM OUTPUT MAGNITUDE vs INPUT MAGNITUDE

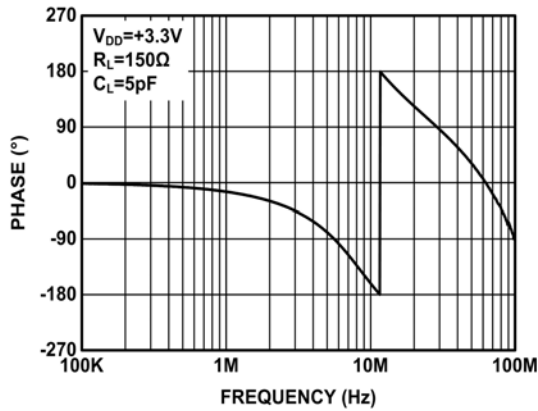

FIGURE 7. PHASE vs FREQUENCY

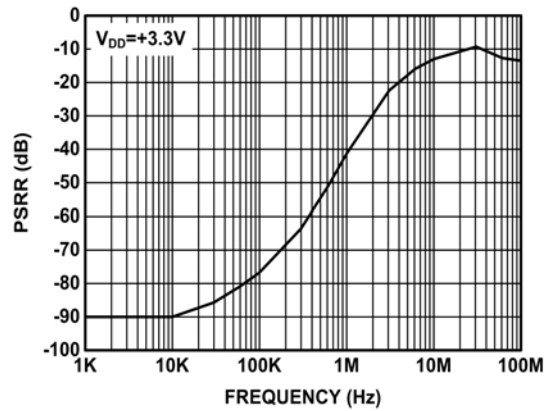

FIGURE 8. PSRR vs FREQUENCY

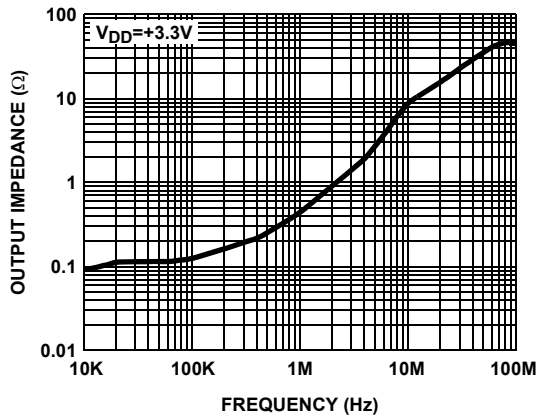

FIGURE 9. OUTPUT IMPEDANCE vs FREQUENCY

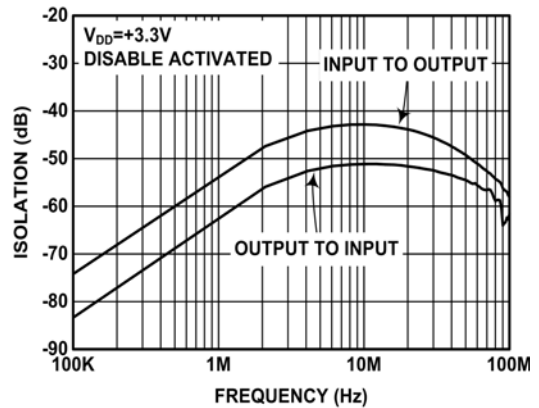

FIGURE 10. ISOLATION vs FREQUENCY

Typical Performance Curves

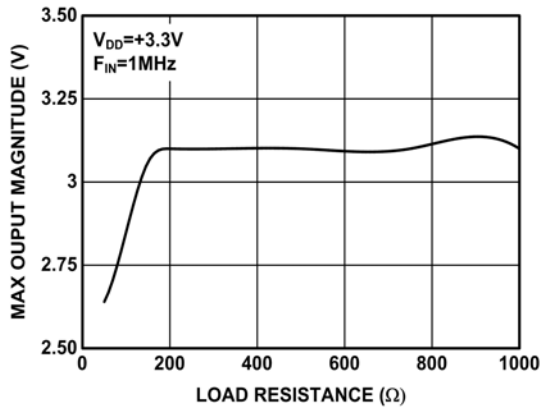

FIGURE 11. MAXIMUM OUTPUT vs LOAD RESISTANCE

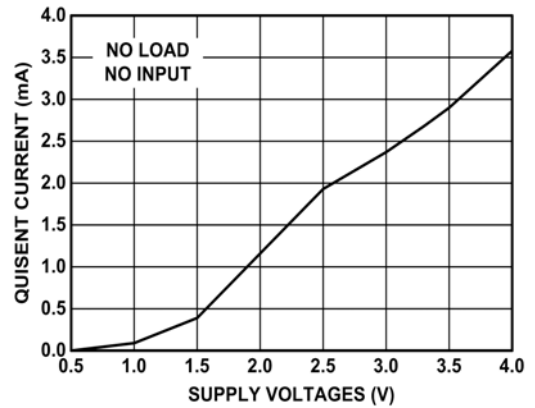

FIGURE 12. SUPPLY CURRENT vs SUPPLY VOLTAGE

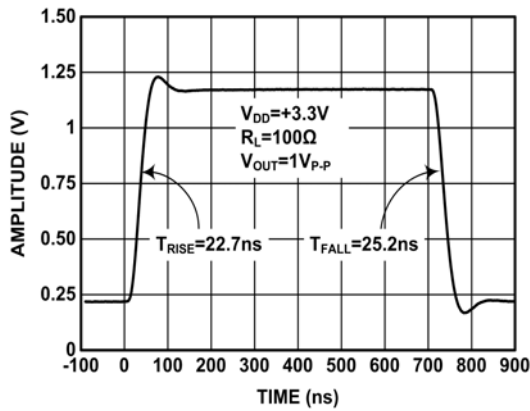

FIGURE 13. LARGE SIGNAL STEP RESPONSE

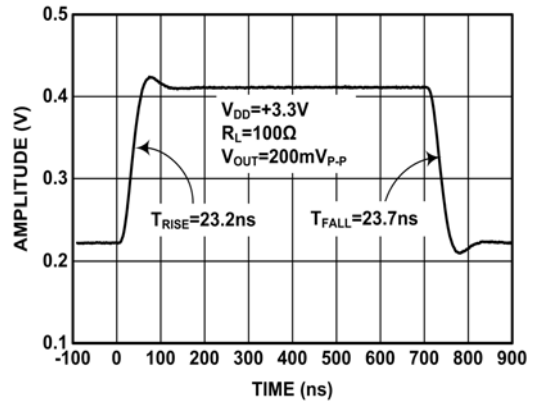

FIGURE 14. SMALL SIGNAL STEP RESPONSE

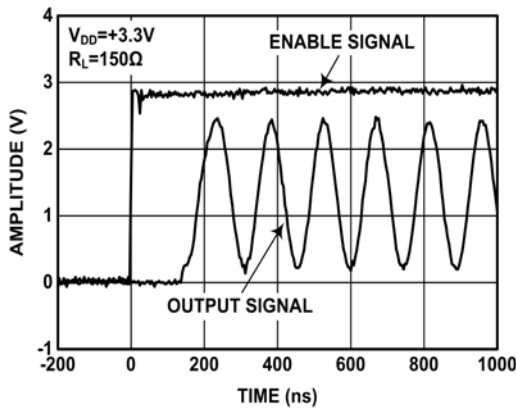

FIGURE 15. ENABLE TIME

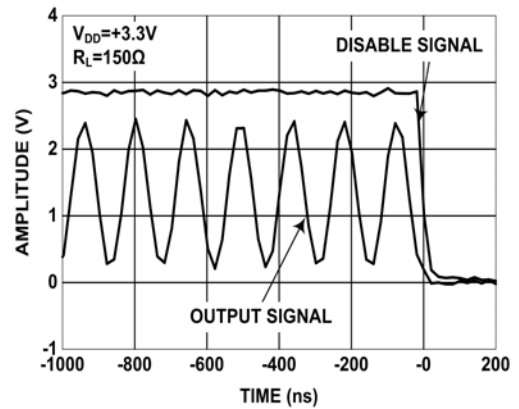

FIGURE 16. DISABLE TIME

Typical Performance Curves

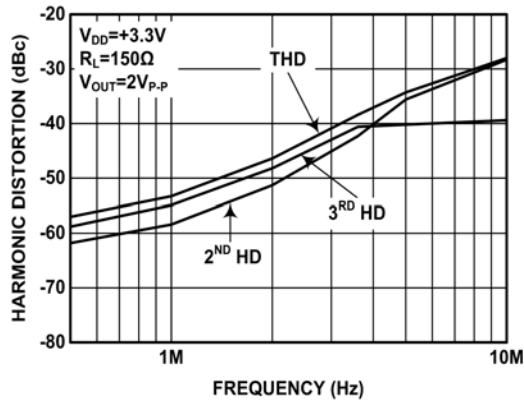

FIGURE 17. HARMONIC DISTORTION vs FREQUENCY

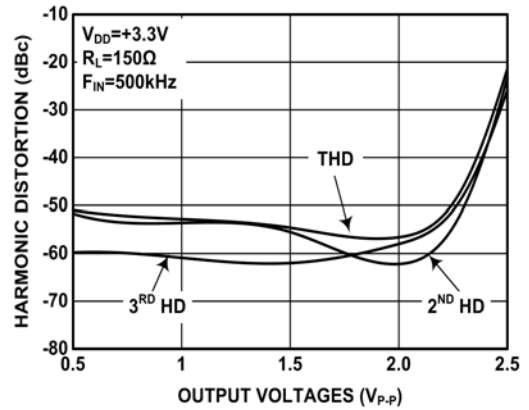

FIGURE 18. HARMONIC DISTORTION vs OUTPUT VOLTAGE

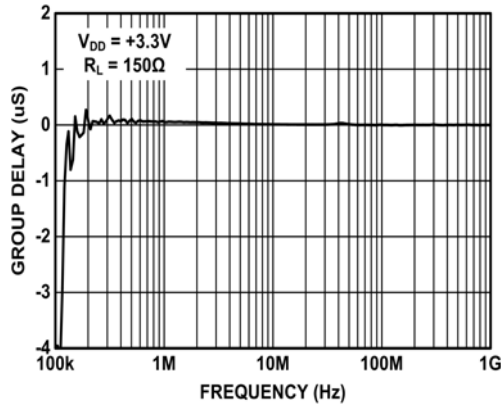

FIGURE 19. GROUP DELAY vs FREQUENCY

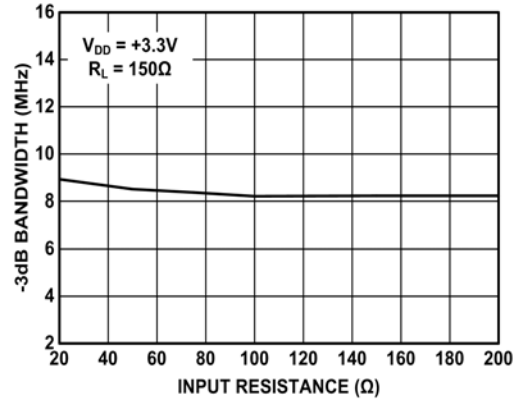

FIGURE 20. -3dB BANDWIDTH vs INPUT RESISTANCE

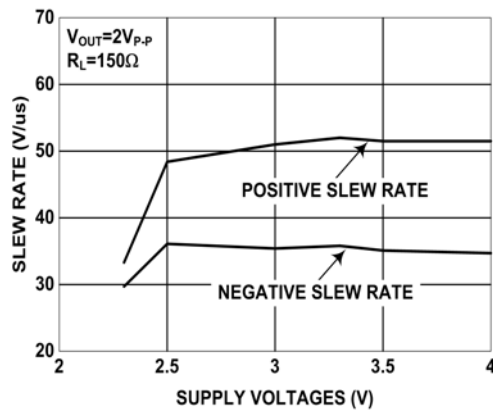

FIGURE 21. SLEW RATE vs SUPPLY VOLTAGE

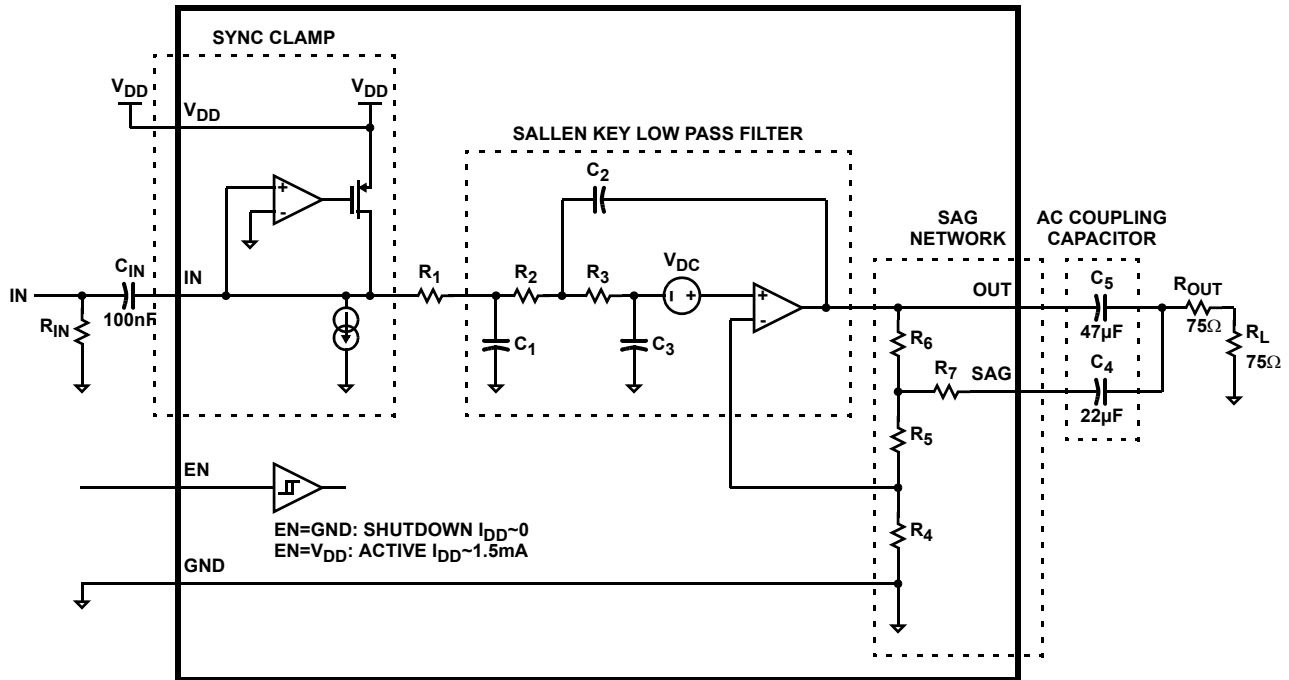

FIGURE 22. BLOCK DIAGRAM

Application Information

The ISL59111 is a single supply rail-to-rail output amplifier achieving a -3dB bandwidth of around 8MHz and slew rate of about 40V/µs while demanding only 2mA of supply current. This part is ideally suited for applications with specific micropower consumption and high bandwidth demands. As the performance characteristics above and the features described below, the ISL59111 is designed to be very attractive for portable composite video applications.

The ISL59111 features a sync clamp, low pass function, and SAG network at the output facilitating reduction of typically large AC coupling capacitors. See Figure 22.

Internal Sync Clamp

The typical embedded video DAC operates from a ground referenced single supply. This becomes an issue because the lower level of the sync pulse output may be at a 0V reference level to some positive level. The problem is presenting a 0V input to most single supply driven amplifiers will saturate the output stage of the amplifier resulting in a clipped sync tip and degrading the video image. A larger positive reference may offset the input above its positive range.

The ISL59111 features an internal sync clamp and offset function to level shift the entire video signal to the best level before it reaches the input of the amplifier stage. These features are also helpful to avoid saturation of the output stage of the amplifier by setting the signal closer to the best voltage range.

The simplified block diagram of the ISL59111 in Figure 22 is divided into four sections. The first, Section A is the Sync Clamp. The AC coupled video sync signal is pulled negative by a current source at the input of the comparator amplifier. When the sync tip goes below the comparator threshold the output comparator is driven negative, The PMOS device turns on clamping sync tip to near ground level. The network triggers on the sync tip of video signal.

The Sallen Key Low Pass Filter

The Sallen Key is a classic low pass configuration illustrated in Figure 22. This provides a very stable low pass function, and in the case of the ISL59111, a three-pole roll-off at around 8MHz. The three-pole function is accomplished with an RC low pass network placed in series with and before the Sallen Key. One pole provided by the RC network and poles two and three provided by the Sallen Key for a nice three-pole roll-off at around 8MHz. If more aggressive, multiple-pole roll-offs are needed, multiple ISL59111 can be placed in series. There will, of course, be a loss of bandwidth as additional devices are added.

AC Output Coupling and the SAG Network

Composite video signals carry viable information at frequencies as low as 30Hz up to 5MHz. When a video system output is AC coupled it is critical that the filter represented by the output coupling capacitor and the surrounding resistance network provide a band pass function with a low pass band low enough to exclude very low frequencies down to DC, and with

a high pass band pass sufficiently high to include frequencies at the higher end of the video spectrum.

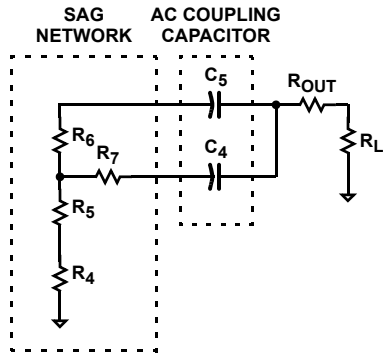

FIGURE 23. SAG NETWORK AND AC COUPLING CAPACITORS

Typically this is accomplished with 220µF coupling capacitor, a large and somewhat costly solution providing a low frequency pole around 5Hz. If the size of this capacitor is even slightly reduced we have found that the accompanying phase shift in the 50Hz to 100Hz frequency range results in field tilt resulting in a degraded video image.

The internal SAG network of the ISL59111 replaces the 220µF AC coupling capacitor with a network of two smaller capacitors as shown in Figure 23. Additionally, the network is designed to place a zero in the ~30Hz range, providing a small amount of peaking to compensate the phase response associated with field tilt.

DC Output Coupling

The ISL59111 internal sync clamp makes it possible to DC couple the output to a video load, eliminating the need for any AC coupling capacitors, saving board space and additional expense for capacitors making the ISL59111 is designed to be extremely attractive for portable video applications. Additionally, this solution completely eliminates the issue of field tilt in the lower frequency. The trade off is greater demand of supply current. Typical load current for AC coupled is around 3mA compared to typical 6mA used when DC coupling.

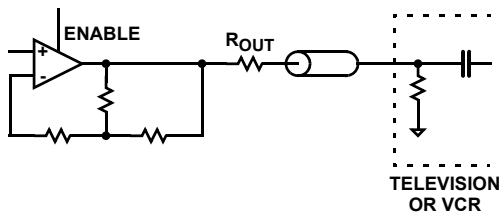

FIGURE 24. DC COUPLE

Output Drive Capability

The ISL59111 does not have internal short circuit protection circuitry. If the output is shorted indefinitely, the power dissipation could easily overheat the die or the current could eventually compromise metal integrity. Maximum reliability is maintained if the output current never exceeds ±40mA. This

limit is set by the design of the internal metal interconnect. Note that in transient applications, the part is robust.

Short circuit protection can be provided externally with a back match resistor in series with the output placed close as possible to the output pin. In video applications this would be a 75Ω resistor and will provide adequate short circuit protection to the device. Care should still be taken not to stress the device with a short at the output.

Power Dissipation

With the high output drive capability of the ISL59111, it is possible to exceed the +125°C absolute maximum junction temperature under certain load current conditions. Therefore, it is important to calculate the maximum junction temperature for an application to determine if load conditions or package types need to be modified to assure operation of the amplifier in a safe operating area.

The maximum power dissipation allowed in a package is determined according to:

$$PD_{MAX} = \frac{T_{JMAX} - T_{AMAX}}{\Theta_{JA}}$$

Where:

T_{JMAX} = Maximum junction temperature

T_{AMAX} = Maximum ambient temperature

Θ_{JA} = Thermal resistance of the package

The maximum power dissipation actually produced by an IC is the total quiescent supply current times the total power supply voltage, plus the power in the IC due to the load, or:

for sourcing:

$$PD_{MAX} = V_S \times I_{SMAX} + (V_S - V_{OUT}) \times \frac{V_{OUT}}{R_L}$$

for sinking:

$$PD_{MAX} = V_S \times I_{SMAX} + (V_{OUT} - V_S) \times I_{LOAD}$$

Where:

V_S = Supply voltage

I_{SMAX} = Maximum quiescent supply current

V_{OUT} = Maximum output voltage of the application

R_{LOAD} = Load resistance tied to ground

I_{LOAD} = Load current

By setting the two PD_{MAX} equations equal to each other, we can solve the output current and R_{LOAD} to avoid the device overheat.

Power Supply Bypassing Printed Circuit Board Layout

As with any modern operational amplifier, a good printed circuit board layout is necessary for optimum performance. Lead lengths should be as short as possible. The power supply pin must be well bypassed to reduce the risk of oscillation. For normal single supply operation, a single 4.7 μ F tantalum capacitor in parallel with a 0.1 μ F ceramic capacitor from V_{S+} to GND will suffice.

Printed Circuit Board Layout

For good AC performance, parasitic capacitance should be kept to minimum. Use of wire wound resistors should be avoided because of their additional series inductance. Use of sockets should also be avoided if possible. Sockets add parasitic inductance and capacitance that can result in compromised performance.

3x2 Chip Scale Package (CSP)

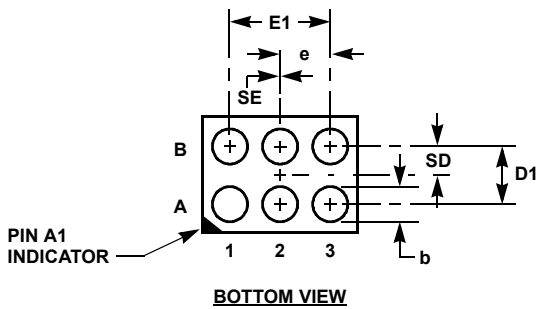
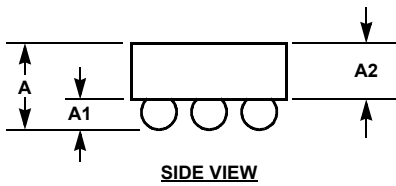
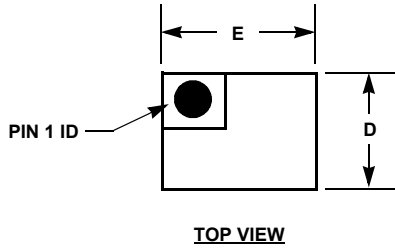

MDP0054
3x2 CHIP SCALE PACKAGE

SYMBOL	MILLIMETERS		
	MIN	NOMINAL	MAX
A	0.54	0.65	0.70
A ₁	0.27	0.29	0.31
A ₂	0.36 REF		
b	∅ 0.34	∅ 0.37	∅ 0.40
D	0.94	0.99	1.04
D ₁	0.50 BASIC		
E	1.44	1.49	1.54
E ₁	1.00 BASIC		
e	0.50 BASIC		
SD	0.25 BASIC		
SE	0.00 BASIC		

Rev. 1 2/07

NOTE:

1. All dimensions are in millimeters.

© Copyright Intersil Americas LLC 2005-2007. All Rights Reserved.
All trademarks and registered trademarks are the property of their respective owners.

For additional products, see www.intersil.com/en/products.html

Intersil products are manufactured, assembled and tested utilizing ISO9001 quality systems as noted in the quality certifications found at www.intersil.com/en/support/qualandreliability.html

Intersil products are sold by description only. Intersil may modify the circuit design and/or specifications of products at any time without notice, provided that such modification does not, in Intersil's sole judgment, affect the form, fit or function of the product. Accordingly, the reader is cautioned to verify that datasheets are current before placing orders. Information furnished by Intersil is believed to be accurate and reliable. However, no responsibility is assumed by Intersil or its subsidiaries for its use; nor for any infringements of patents or other rights of third parties which may result from its use. No license is granted by implication or otherwise under any patent or patent rights of Intersil or its subsidiaries.

For information regarding Intersil Corporation and its products, see www.intersil.com