

ISL54003, ISL54005, ISL54006

Integrated Audio Amplifier Systems

**NOT RECOMMENDED FOR NEW DESIGNS
NO RECOMMENDED REPLACEMENT**
contact our Technical Support Center at
1-888-INTERSIL or www.intersil.com/tsc

FN6514
Rev 2.00
October 30, 2007

The Intersil ISL54003, ISL54005, ISL54006 family of devices are integrated audio power amplifier systems that combine a mono BTL amplifier and stereo headphone amplifiers in a single device. The devices are designed to operate from a single +2.7V to +5V power supply. Targeted applications include handheld equipment such as cell-phones, MP3 players, and games/toys.

These parts contain one class AB BTL type power amplifier for driving an 8Ω mono speaker and two class AB headphone amplifiers for driving 16Ω or 32Ω headphone speakers.

The BTL when using a 5V supply is capable of delivering 800mW (typ) with 0.4% THD+N and 941mW (typ) with 1% THD+N of continuous average power into an 8Ω BTL speaker load.

Each headphone amplifier when using a 5V supply is capable of delivering 50mW (typ) with 0.3% THD+N and 94mW (typ) with 1% THD+N of continuous average power into a 32Ω headphone speaker.

When in Mono Mode these devices automatically mix the active left and right audio inputs and send the combined signal to the BTL driver. In Headphone Mode the active right channel input is sent to the right headphone speaker and the active left channel is sent to the left headphone speaker.

The ISL54005 and ISL54006 feature a 2:1 stereo input multiplexer front-end. This allows selection between two stereo sources. In addition the ISL54006 can mix the four inputs to the BTL driver or the two pairs of inputs to the headphone drivers.

These parts feature headphone sense circuitry that detects when a headphone jack has been inserted and automatically switches the active audio inputs from the mono BTL output driver to the headphone drivers. These parts also feature a logic control pin that can override the headphone sense input circuitry.

All devices in this family feature low power shutdown, thermal overload protection and click/pop suppression. The click and pop circuitry eliminates audible transients during audio source changes and transitioning in and out of shutdown.

Features

- Pb-Free (RoHS Compliant)
- Class AB 94mW Headphone Amplifiers and 941mW Mono BTL Speaker Amplifier
- THD+N at 1kHz, 800mW into 8Ω BTL 0.4%
- THD+N at 1kHz, 15mW into 32Ω Headphone 0.07%
- THD+N at 1kHz, 50mW into 32Ω Headphone 0.3%
- Single Supply Operation. +2.7V to +5.5V
- Headphone Sense Input and Low Power Shutdown
- Thermal Shutdown Protection
- “Click and Pop” Suppression Circuitry
- 2:1 Stereo Input Mux (ISL54005, ISL54006)
- Mixing of Two Stereo Inputs (ISL54006)
- TTL Logic-Compatible
- Available in 20 Ld 4x4 Thin QFN

Applications

- Battery powered, Handheld, and Portable Equipment
 - Cellular/mobile Phones
 - PDA's, MP3 Players, DVD Players, Cameras
 - Laptops, Notebooks, Palmtops
 - Handheld Games and Toys
- Desktop Computers

Simplified Block Diagram

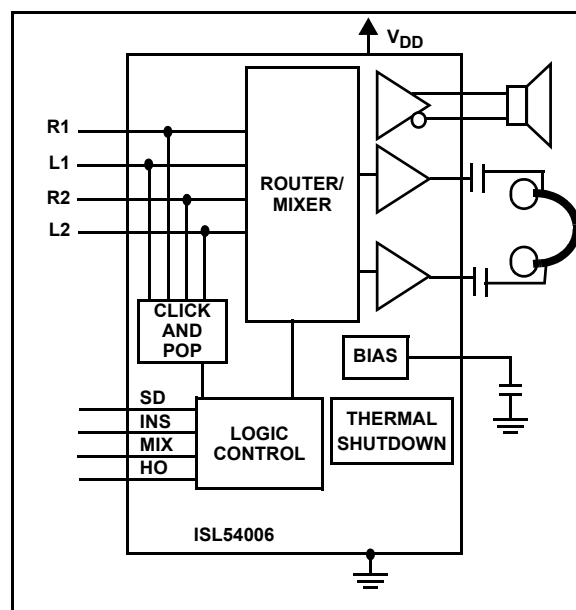

Pinouts

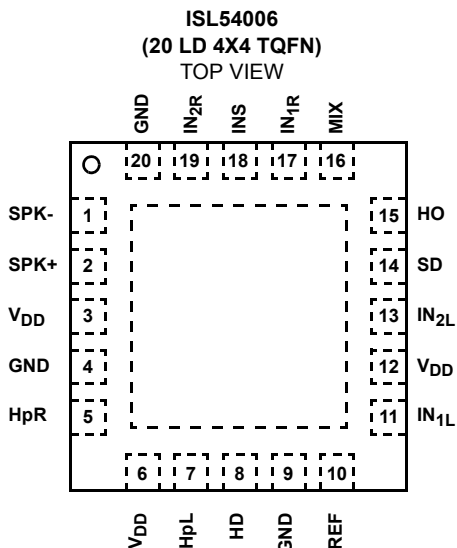
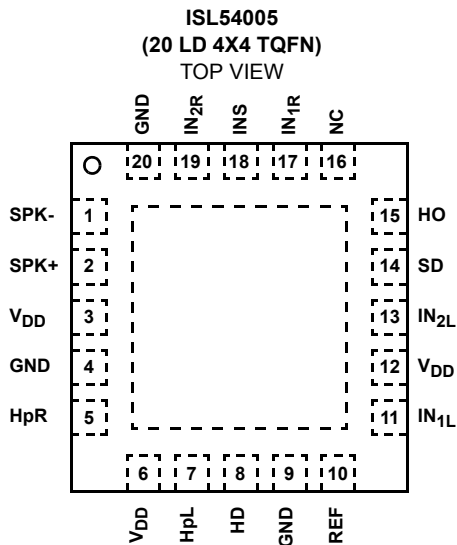
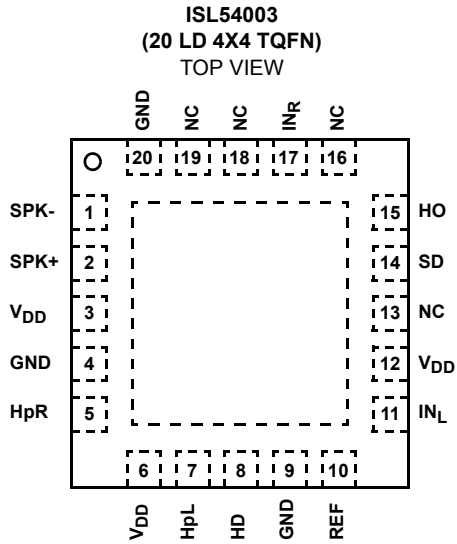

Pin Descriptions

PIN			NAME	FUNCTION
ISL54003	ISL54005	ISL54006		
3, 6, 12	3, 6, 12	3, 6, 12	V _{DD}	System Power Supply
4, 9, 20	4, 9, 20	4, 9, 20	GND	Ground Connection
11			IN _L	Left Channel Audio Input 1
	11	11	IN _{1L}	Left Channel Audio Input 1
-	13	13	IN _{2L}	Left Channel Audio Input 2
17			IN _R	Right Channel Audio Input 1
	17	17	IN _{1R}	Right Channel Audio Input 1
-	19	19	IN _{2R}	Right Channel Audio Input 2
5	5	5	HpR	Headphone Right Output
7	7	7	HpL	Headphone Left Output
2	2	2	SPK+	Positive Speaker Output
1	1	1	SPK-	Negative Speaker Output
14	14	14	SD	Shutdown, High to disable amplifiers, Low for normal operation.
8	8	8	HD	Headphone Detection, Internally pulled up to V _{DD} , Low in Mono Mode, High in Headphone Mode if HO = Low
15	15	15	HO	Headphone Override, High in Mono Mode, Low in Headphone Mode if HD = High
-	18	18	INS	Input Select
-	-	16	MIX	Mixer, High to mix Right and Left Audio Inputs, Low to pass Audio Inputs without mixing
10	10	10	REF	Common-mode Bias Voltage, Bypass with a 1μF capacitor to GND.
13, 16, 18, 19	16		NC	No Connect

Ordering Information

PART NUMBER (Note)	PART MARKING	TEMP. RANGE (°C)	PACKAGE Tape & Reel (Pb-Free)	PKG. DWG. #
ISL54003IRTZ*	540 03IRTZ	-40 to +85	20 Ld 4x4 TQFN	L20.4x4A
ISL54005IRTZ*	540 05IRTZ	-40 to +85	20 Ld 4x4 TQFN	L20.4x4A
ISL54006IRTZ*	540 06IRTZ	-40 to +85	20 Ld 4x4 TQFN	L20.4x4A

*Add "-T" suffix for tape and reel. Please refer to TB347 for details on reel specifications.

NOTE: These Intersil Pb-free plastic packaged products employ special Pb-free material sets; molding compounds/die attach materials and 100% matte tin plate PLUS ANNEAL - e3 termination finish, which is RoHS compliant and compatible with both SnPb and Pb-free soldering operations. Intersil Pb-free products are MSL classified at Pb-free peak reflow temperatures that meet or exceed the Pb-free requirements of IPC/JEDEC J STD-020.

ISL54003 Truth Table

SD	HD	HO	SPK+/SPK-	HpR	HpL
1	X	X	Disabled	Disabled	Disabled
0	0	X	IN _R + IN _L	-	-
0	1	0	-	IN _R	IN _L
0	1	1	IN _R + IN _L	-	-

ISL54005 Truth Table

SD	INS	HD	HO	SPK+/SPK-	HpR	HpL
1	X	X	X	Disabled	Disabled	Disabled
0	0	0	X	IN _{1R} + IN _{1L}	-	-
0	0	1	0	-	IN _{1R}	IN _{1L}
0	0	1	1	IN _{1R} + IN _{1L}	-	-
0	1	0	X	IN _{2R} + IN _{2L}	-	-
0	1	1	0	-	IN _{2R}	IN _{2L}
0	1	1	1	IN _{2R} + IN _{2L}	-	-

ISL54006 Truth Table

SD	MIX	INS	HD	HO	SPK+/SPK-	HpR	HpL
1	X	X	X	X	Disabled	Disabled	Disabled
0	0	0	0	X	IN _{1R} + IN _{1L}	-	-
0	0	0	1	0	-	IN _{1R}	IN _{1L}
0	0	0	1	1	IN _{1R} + IN _{1L}	-	-
0	0	1	0	X	IN _{2R} + IN _{2L}	-	-
0	0	1	1	0	-	IN _{2R}	IN _{2L}
0	0	1	1	1	IN _{2R} + IN _{2L}	-	-
0	1	X	0	X	IN _{1R} + IN _{2R} + IN _{1L} + IN _{2L}	-	-
0	1	X	1	0	-	IN _{1R} + IN _{2R}	IN _{1L} + IN _{2L}
0	1	X	1	1	IN _{1R} + IN _{2R} + IN _{1L} + IN _{2L}	-	-

Absolute Maximum Ratings

VDD to GND	-0.3 to +6.5V
Input Voltages	
In_R, In_L, SD, INS, MIX, H_	-0.3 to (VDD + 0.3V)
Output Voltages	
SPK+, SPK-, Hp_	-0.3 to (VDD + 0.3V)
Continuous Current (VDD, SPK_, Hp_, GND)	750mA
ESD Rating:	
Human Body Model	>2kV
Machine Model	>200V
Charged Device Model	>1kV

Thermal Information

Thermal Resistance (Typical, Notes 1, 2)	θ_{JA} (°C/W)	θ_{JC} (°C/W)
20 Ld 4x4 TQFN Package	45	6.5
Maximum Junction Temperature	+150°C	
Maximum Storage Temperature Range	-65°C to +150°C	
Pb-free reflow profile	see link below	
	http://www.intersil.com/pbfree/Pb-FreeReflow.asp	

Operating Conditions

Temperature Range	-40°C to +85°C
-------------------	----------------

CAUTION: Do not operate at or near the maximum ratings listed for extended periods of time. Exposure to such conditions may adversely impact product reliability and result in failures not covered by warranty.

NOTE:

- θ_{JA} is measured in free air with the component mounted on a high effective thermal conductivity test board with "direct attach" features. θ_{JC} , the "case temp" is measured at the center of the exposed metal pad on the package underside. See Tech Brief TB379.
- For θ_{JC} , the "case temp" location is the center of the exposed metal pad on the package underside.

Electrical Specifications - 5V Supply

Test Conditions: $V_{DD} = +5V$, $GND = 0V$, $V_{INH} = 2.4V$, $V_{INL} = 0.8V$, $SD = MIX = INS = HD = V_{INL}$, $C_{REF} = 1\mu F$, R_L is terminated between SPK+ and SPK- for BTL driver and between Hp_ and GND for SE drivers, Unless Otherwise Specified (Note 3).

PARAMETER	TEST CONDITIONS	TEMP (°C)	MIN (Notes 4, 5)	TYP	MAX (Notes 4, 5)	UNITS	
GENERAL							
Power Supply Range, V_{DD}		Full	2.7	-	5.5	V	
Quiescent Supply Current, I_{DD}	HO = V_{INL} or V_{INH} , HD = V_{INL} , INS = V_{INL} or V_{INH} , MIX = V_{INL} or V_{INH} , $R_L = \text{None}$, Inputs AC coupled to ground (0.13 μF)	25	-	4.6	12	mA	
		Full	-	5.5	-	mA	
Shutdown Supply Current, I_{SD}	SD = V_{INH} , HO = V_{INL} or V_{INH} , HD = V_{INL} , INS = V_{INL} or V_{INH} , MIX = V_{INL} or V_{INH} , $R_L = 8\Omega$ (BTL) and $R_L = 32\Omega$ (SE), Inputs AC coupled to ground (0.1 μF)	25	-	28	50	μA	
		Full	-	31	-	μA	
Input Resistance, R_{IN}	INS = 0V or V_{DD}	25	-	100	-	k Ω	
Thermal Shutdown, T_{SD}	INS = MIX = 0V or V_{DD}	25	-	150	-	°C	
Thermal Shutdown Hysteresis		25	-	10	-	°C	
SD to Full Operation, $t_{SD(ON)}$	INS = 0V or 5V, MIX = 0V or 5V	Full	-	1	-	ms	
BTL AMPLIFIER DRIVER, HD = V_{INL}, HO = V_{INH}, UNLESS OTHERWISE SPECIFIED							
Output Offset Voltage, V_{OS}	Measured between SPK+ and SPK-, Inputs AC coupled to ground (0.1 μF)	25	-	38	-	mV	
		Full	-	49	-	mV	
Power Supply Rejection Ratio, PSRR	$V_{RIPPLE} = 200mV_{P-P}$, HD = V_{INL} , $R_L = 8\Omega$, Inputs AC coupled to ground (0.1 μF)	$F_{RIPPLE} = 217Hz$	25	-	49	-	dB
		$F_{RIPPLE} = 1kHz$	25	-	47	-	dB
Output Power, P_{OUT}	$R_L = 8\Omega$, THD+N = 1%, f = 1kHz	25	-	941	-	mW	
	$R_L = 8\Omega$, THD+N = 10%, f = 1kHz	25	-	1.23	-	W	
Total Harmonic Distortion + Noise, THD + N	$R_L = 8\Omega$, $P_{OUT} = 800mW$, f = 1kHz	25	-	0.4	-	%	
	$R_L = 8\Omega$, $P_{OUT} = 800mW$, f = 20Hz to 20kHz	25	-	0.7	-	%	
Max Output Voltage Swing, V_{OUT}	$R_L = 8\Omega$, $V_{SIGNAL} = 5V_{P-P}$, f = 1kHz	25	7.2	7.7	-	V_{P-P}	
Signal to Noise Ratio, SNR	$R_L = 8\Omega$, $P_{OUT} = 900mW$, f = 1kHz	25	-	85	-	dB	
Output Noise, N_{OUT}	A - Weight filter, BW = 22Hz to 22kHz	25	-	140	-	μV_{RMS}	

Electrical Specifications - 5V Supply

Test Conditions: $V_{DD} = +5V$, $GND = 0V$, $V_{INH} = 2.4V$, $V_{INL} = 0.8V$, $SD = MIX = INS = HD = V_{INL}$, $C_{REF} = 1\mu F$, R_L is terminated between SPK+ and SPK- for BTL driver and between Hp_ and GND for SE drivers, Unless Otherwise Specified (Note 3). **(Continued)**

PARAMETER	TEST CONDITIONS	TEMP (°C)	MIN (Notes 4, 5)	TYP	MAX (Notes 4, 5)	UNITS
Crosstalk R_{CH} to L_{CH} , L_{CH} to R_{CH}	$R_L = 8\Omega$, $P_{OUT} = 800mW$, $f = 1kHz$, Signal coupled from the input of active amplifier to the output of an adjacent amplifier with its input AC coupled to ground.	25	-	80	-	dB
Off-Isolation	$SD = V_{DD}$, $P_{OUT} = 800mW$, $f = 10kHz$, Signal coupled from input to output of a disabled amplifier.	25	-	130	-	dB
SINGLE ENDED AMPLIFIER DRIVERS, $HD = V_{INH}$, $HO = V_{INL}$, UNLESS OTHERWISE SPECIFIED						
Power Supply Rejection Ratio, PSRR	$V_{RIPPLE} = 200mV_{P-P}$, $HD = 0V$, $R_L = 32\Omega$, Input AC coupled to ground (0.1 μF)	$F_{RIPPLE} = 217Hz$	25	-	48	dB
		$F_{RIPPLE} = 1kHz$	25	-	47	dB
Output Power, P_{OUT}	$R_L = 16\Omega$, THD+N = 1%, $f = 1kHz$	25	-	170	-	mW
	$R_L = 32\Omega$, THD+N = 1%, $f = 1kHz$	25	-	94	-	mW
	$R_L = 16\Omega$, THD+N = 10%, $f = 1kHz$	25	-	215	-	mW
	$R_L = 32\Omega$, THD+N = 10%, $f = 1kHz$	25	-	116	-	mW
Total Harmonic Distortion + Noise, THD + N	$R_L = 32\Omega$, $P_{OUT} = 15mW$, $f = 1kHz$	25	-	0.07	-	%
	$R_L = 32\Omega$, $P_{OUT} = 15mW$, $f = 20Hz$ to 20kHz	25	-	0.09	-	%
	$R_L = 32\Omega$, $P_{OUT} = 50mW$, $f = 1kHz$	25	-	0.3	-	%
	$R_L = 32\Omega$, $P_{OUT} = 50mW$, $f = 20Hz$ to 20kHz	25	-	0.4	-	%
Max Output Voltage Swing, V_{OUT}	$R_L = 32\Omega$, $V_{SIGNAL} = 5V_{P-P}$, $f = 1kHz$	25	3.6	4.7	-	V_{P-P}
Crosstalk R_{CH} to L_{CH} , L_{CH} to R_{CH}	$R_L = 32\Omega$, $P_{OUT} = 15mW$, $f = 1kHz$	25	-	75	-	dB
Off-Isolation	$SD = V_{DD}$, $R_L = 32\Omega$, $P_{OUT} = 15mW$, $f = 10kHz$	25	-	120	-	dB
Signal to Noise Ratio, SNR	$R_L = 32\Omega$, $P_{OUT} = 50mW$, $f = 1kHz$	25	-	85	-	dB
Channel Gain Matching R_{CH} to L_{CH}	$R_L = 32\Omega$, $V_{INxR} = V_{INxL} = 1.3V_{RMS}$ (Connect to the same source)	25	-	± 0.2	-	dB
Channel Phase Matching R_{CH} to L_{CH}	$R_L = 32\Omega$, $V_{INxR} = V_{INxL} = 1.3V_{RMS}$ (Connect to the same source)	25	-	1.3	-	°
LOGIC INPUT						
Input Leakage Current, I_{SD} , I_{INS} , I_{MIX} , I_{HD} , I_{HO}	$V_{DD} = 5V$, $SD = 0V$, $INS = 0V$, $MIX = 0V$, $HD = 0V$, $HO = 0V$	25	-3	1.9	3	μA
		Full	-	1.9	-	μA
Input Leakage Current, I_{SD} , I_{INS} , I_{MIX} , I_{HD} , I_{HO}	$V_{DD} = 5V$, $SD = V_{DD}$, $INS = V_{DD}$, $MIX = V_{DD}$, $HD = V_{DD}$, $HO = V_{DD}$	25	-1	0.02	1	μA
		Full	-	0.02	-	μA
V_{INH}		Full	2.4	-	-	V
V_{INL}		Full	-	-	0.8	V

Electrical Specifications - 3.6V Supply Test Conditions: $V_{DD} = +3.6V$, $GND = 0V$, $V_{INH} = 1.4V$, $V_{INL} = 0.4V$, $SD = MIX = INS = GSO = GS1 = V_{INL}$, $C_{REF} = 1\mu F$, R_L is terminated between SPK+ and SPK- for BTL driver and between Hp_ and GND for SE drivers, Unless Otherwise Specified (Note 3).

PARAMETER	TEST CONDITIONS	TEMP (°C)	MIN (Notes 4, 5)	TYP	MAX (Notes 4, 5)	UNITS
GENERAL						
Quiescent Supply Current, I_{DD}	HO = V_{INL} or V_{INH} , HD = V_{INL} , INS = V_{INL} or V_{INH} , MIX = V_{INL} or V_{INH} , RL = None, Input AC coupled to ground (0.1 μ F)	25	-	2.7	12	mA
		Full	-	3	-	mA
Shutdown Supply Current, I_{SD}	SD = V_{DD} , HO = V_{INL} or V_{INH} , HD = Float, INS = V_{INL} or V_{INH} , MIX = V_{INL} or V_{INH} , RL = 8 Ω (BTL) and RL = 32 Ω (SE), Input AC coupled to ground (0.1 μ F)	25	-	13	50	μ A
		Full	-	15	-	μ A
BTL AMPLIFIER DRIVER, HD = V_{INH}, HO = V_{INH}, UNLESS OTHERWISE SPECIFIED						
Output Offset Voltage, V_{OS}	Measured between SPK+ and SPK-, Input AC coupled to ground (0.1 μ F)	25	-	25	-	mV
		Full	-	40	-	mV
Power Supply Rejection Ratio, PSRR	$V_{RIPPLE} = 200mV_{P-P}$, HD = 0V, RL = 8 Ω , input AC coupled to ground (0.1 μ F)	$F_{RIPPLE} = 217Hz$	25	-	49	dB
		$F_{RIPPLE} = 1kHz$	25	-	47	dB
Output Power, P_{OUT}	RL = 8 Ω , THD+N = 1%, f = 1kHz	25	-	310	-	mW
	RL = 8 Ω , THD+N = 10%, f = 1kHz	25	-	528	-	mW
Total Harmonic Distortion + Noise, THD + N	RL = 8 Ω , $P_{OUT} = 200mW$, f = 1kHz	25	-	0.4	-	%
	RL = 8 Ω , $P_{OUT} = 200mW$, f = 20Hz to 20kHz	25	-	0.4	-	%
Max Output Voltage Swing, V_{OUT}	RL = 8 Ω , $V_{SIGNAL} = 3.6V_{P-P}$, f = 1kHz	25	-	5.8	-	V_{P-P}
SINGLE ENDED AMPLIFIER DRIVERS, HD = V_{INH}, HO = V_{INL}, UNLESS OTHERWISE SPECIFIED						
Power Supply Rejection Ratio, PSRR	$V_{RIPPLE} = 200mV_{P-P}$, HD = 0V, RL = 32 Ω , Input AC coupled to ground (0.1 μ F)	$F_{RIPPLE} = 217Hz$	25	-	48	dB
		$F_{RIPPLE} = 1kHz$	25	-	47	dB
Output Power, P_{OUT}	RL = 16 Ω , THD+N = 1%, f = 1kHz	25	-	80	-	mW
	RL = 32 Ω , THD+N = 1%, f = 1kHz	25	-	47	-	mW
	RL = 16 Ω , THD+N = 10%, f = 1kHz	25	-	107	-	mW
	RL = 32 Ω , THD+N = 10%, f = 1kHz	25	-	58	-	mW
Total Harmonic Distortion + Noise, THD + N	RL = 32 Ω , $P_{OUT} = 15mW$, f = 1kHz	25	-	0.15	-	%
	RL = 32 Ω , $P_{OUT} = 15mW$, f = 20Hz to 20kHz	25	-	0.15	-	%
Max Output Voltage Swing, V_{OUT}	RL = 32 Ω , $V_{SIGNAL} = 3.6V_{P-P}$, f = 1kHz	25	-	3.2	-	V_{P-P}
LOGIC INPUT						
Input Leakage Current, I_{SD} , I_{INS} , I_{MIX} , I_{HD} , I_{HO}	$V_{DD} = 3.6V$, SD = 0V, INS = 0V, MIX = 0V, HD = 0V, HO = 0V	25	-	1.9	-	μ A
		Full	-	1.9	-	μ A
Input Leakage Current, I_{SD} , I_{INS} , I_{MIX} , I_{HD} , I_{HO}	$V_{DD} = 3.6V$, SD = V_{DD} , INS = V_{DD} , MIX = V_{DD} , HD = V_{DD} , HO = V_{DD}	25	-	0.02	-	μ A
		Full	-	0.02	-	μ A
V_{INH}		Full	1.4	-	-	V
V_{INL}		Full	-	-	0.4	V

NOTES:

- V_{IN} = input voltage to perform proper function.
- The algebraic convention, whereby the most negative value is a minimum and the most positive a maximum, is used in this data sheet.
- Parts are 100% tested at +25°C. Over-temperature limits established by characterization and are not production tested.

ISL54003 Typical Application Circuit and Block Diagram

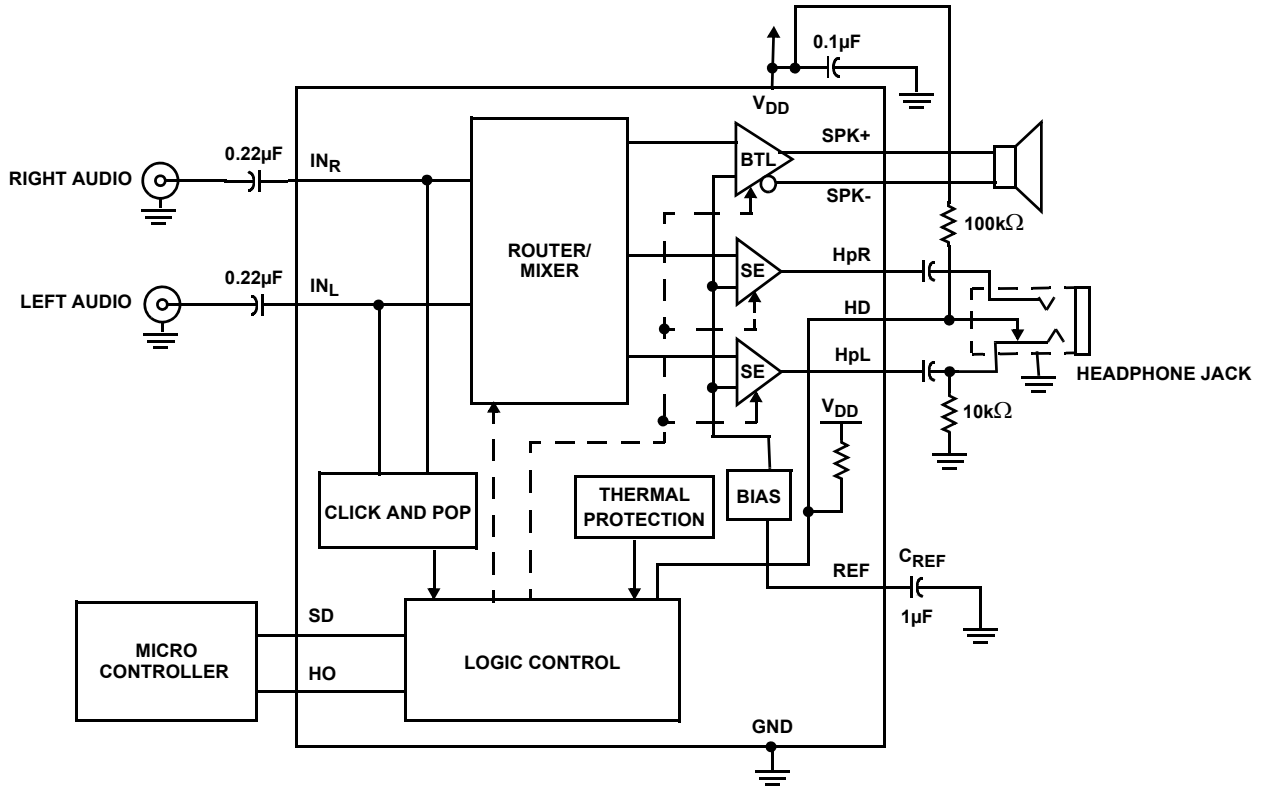

ISL54005 Typical Application Circuit and Block Diagram

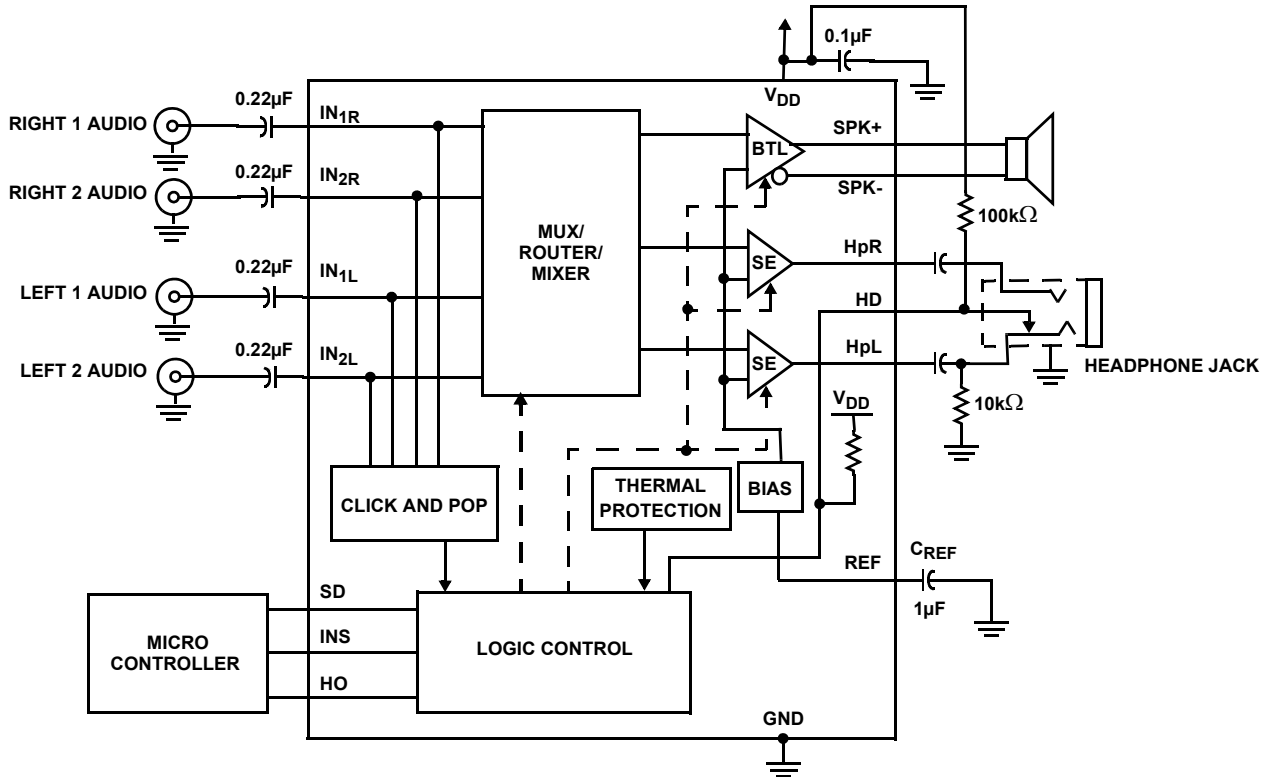

ISL54006 Typical Application Circuit and Block Diagram

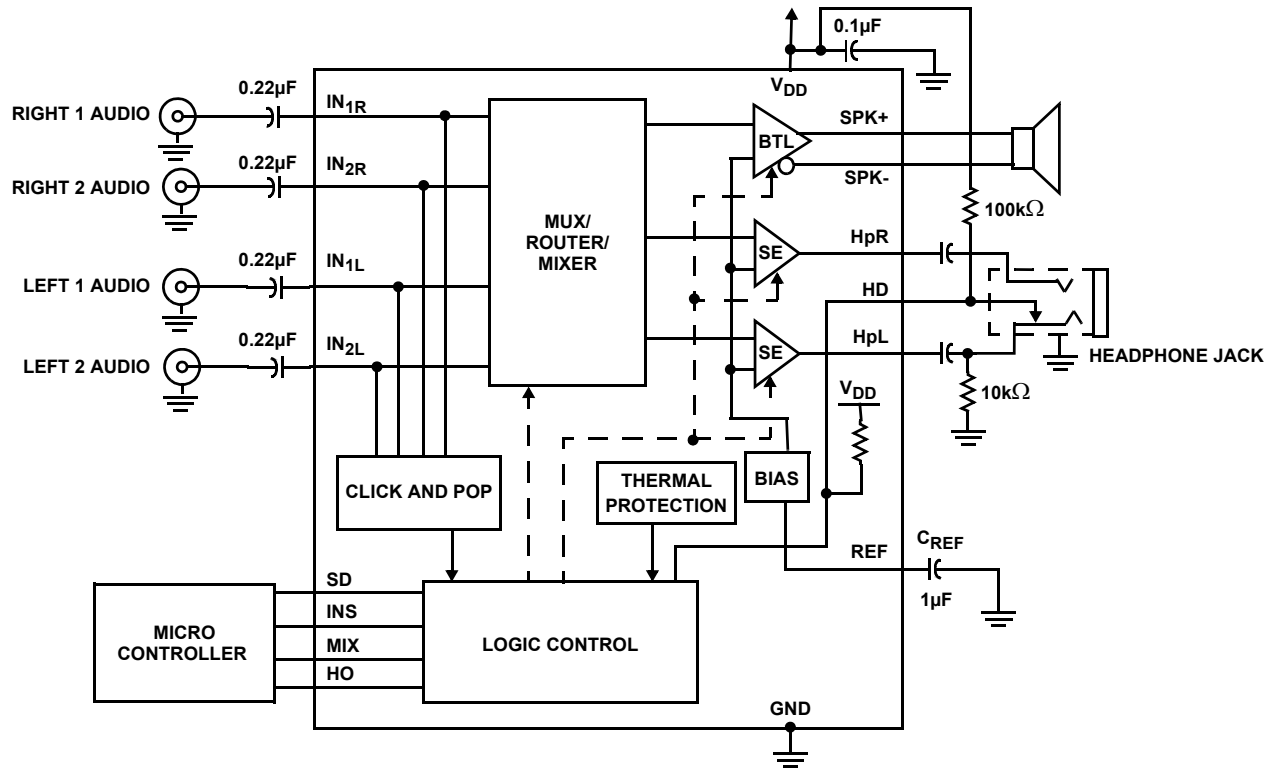

Detailed Description

The Intersil ISL54003, ISL54005, and ISL54006 family of devices are integrated audio power amplifier systems designed to provide quality audio, while requiring minimal external components. The low 0.4% THD+N ensures clean, low distortion amplification of the audio signals. The devices are designed to operate from a single +2.7V to +5V power supply. All devices are offered in a 20 Ld 4x4 TQFN package. Targeted applications include battery powered equipment such as cell-phones, MP3 players, and games/toys.

These parts contain one class AB BTL type power amplifier for driving an 8Ω mono speaker and two class AB single-ended (SE) type amplifiers for driving 16Ω or 32Ω headphones.

The BTL when using a 5V supply is capable of delivering 800mW (typ) with 0.4% THD+N and 941mW (typ) with 1% THD+N of continuous average power into an 8Ω BTL speaker load. When the speaker load is connected across the positive and negative terminals of the BTL driver the voltage is doubled across the load and the power is quadrupled.

Each SE amplifier when using a 5V supply is capable of delivering 15mW (typ) with 0.07% THD+N and 50mW (typ) with 0.3% THD+N of continuous average power into a 32Ω headphone speaker.

When in Mono Mode (BTL driver active) these devices automatically mix the active left and right audio inputs and send

the combined signal to the BTL driver. In Headphone Mode the active right channel input is sent to the right headphone speaker and the active left channel is sent to the left headphone speaker.

The ISL54005 and ISL54006 feature a 2:1 stereo input multiplexer front-end. This allows selection between two stereo sources. The INS control pin determines which stereo input is active. Applying logic "0" to the INS control pin selects stereo input 1 (R₁ and L₁). Applying logic "1" to the INS control pin selects stereo input 2 (R₂ and L₂).

The ISL54006 has the capability of mixing the two stereo inputs. When in MIX Mode and HEADPHONE Mode, the part mixes the R₁ input with the R₂ input and sends the combined signal to the HpR headphone driver and it mixes the L₁ input with the L₂ input and sends the combined signal to the HpL headphone driver. When in MIX Mode and MONO Mode, it mixes all four inputs (R₁ + R₂ + L₁ + L₂) and sends the combined signal to the BTL mono driver.

These parts have headphone sense input circuitry that detects when a headphone jack has been inserted and automatically switches the active audio inputs from the mono BTL output driver to the headphone drivers. These parts also feature a logic control pin (HO) that can override the sense input circuitry.

All devices in this family feature low power shutdown, thermal overload protection and click/pop suppression. The click and

pop circuitry prohibits switching between input channels until the audio input signals are at their lowest point which eliminates audible transients in the speakers when changing the audio input sources. The click/pop circuitry also keeps speaker transients to an inaudible level when entering and leaving shutdown.

“Typical Application Circuits and Block Diagrams” for each device in the family are provided on page 7 and page 8. Truth tables for each device are provided on page 3.

DC Bias Voltage

The ISL54003, ISL54005, and ISL54006 have internal DC bias circuitry, which DC offsets the incoming audio signal at $V_{DD}/2$. When using a 5V supply, the DC offset will be 2.5V. When using a 3.6V supply, the DC offset will be 1.8V.

Since the signal gets biased internally at $V_{DD}/2$ the audio signals need to be AC coupled to the inputs of the device. The value of the AC coupling capacitor depends on the low frequency range required for the application. A capacitor of 0.22 μ F will pass a signal as low as 7.2Hz. The formula required to calculate the capacitor value is shown in Equation 1:

$$C \geq 1/6.28 \cdot f \cdot 100k\Omega \quad (\text{EQ. 1})$$

The 100k Ω is the impedance looking into the input of the ISL54003, ISL54004, ISL54006 devices.

BTL Speaker Amplifier

The ISL54003, ISL54005, and ISL54006 contain one bridge-tied load (BTL) amplifier designed to drive an 8 Ω speaker load differentially. The output to the BTL amplifier are SPK+ and SPK-. The speaker load gets connected across these terminals.

A single BTL driver consists of an inverting and non-inverting power op amps. The AC signal out of each op amp are equal in magnitude but 180° out-of-phase, so the AC signal at SPK+ and SPK- have the same amplitude but are 180° out-of-phase.

Driving the load differentially using a BTL configuration doubles the output voltage across the speaker load and quadruples the power to the load. In effect you get a gain of two due to this configuration at the load as compared to driving the load with a single-ended amplifier with its load connected between a single amplifier's output and ground.

The outputs of the BTL are biased at $V_{DD}/2$. When the load gets connected across the + and - terminal of the BTL the mid supply DC bias voltage at each output gets cancelled out eliminating the need for large bulky output coupling capacitors.

Headphone (Single-Ended) Amplifiers

The ISL54003, ISL54005, and ISL54006 contains two single-ended (SE) headphone amplifiers for driving the left and right channels of a 32 Ω or 16 Ω headphone speaker.

One SE amplifier drives the right speaker of the headphone and other SE amplifier drives the left speaker of the headphone. The speaker load gets connected between the output of the amplifier and ground.

The audio signal at the output of each SE driver is biased at $V_{DD}/2$ and unlike the BTL driver that cancels this offset due to its differential connection, a capacitor is required at the output of each SE drivers to remove this DC voltage from the headphone load.

This coupling capacitor along with the resistance of the speaker load creates a high pass filter that sets the amplifier's lower bandpass frequency limit. The value of this AC coupling capacitor depends on the low frequency range required by the application. The formula required to calculate the capacitor value is shown in Equation 2:

$$C \geq 1/6.28 \cdot f \cdot R_{\text{speaker}} \quad (\text{EQ. 2})$$

For an application driving a 32 Ω headphone with a lower frequency requirement of 150Hz, the required capacitor value would be determined by using Equation 3:

$$C \geq 1/6.28 \cdot 150 \cdot 32 = 33\mu\text{F} \quad (\text{EQ. 3})$$

Use the closest standard value.

Headphone Sense Function

With a logic “1” at the HP control pin while the HO control pin is low will activate the headphone drivers and disable the BTL driver.

The “Typical Application Circuits and Block Diagrams” on page 7 and page 8 show the implementation of the headphone control function using a common headphone jack.

The HP pin gets connected to the mechanical wiper blade of the headphone jack. Two external resistors are required for proper operation. A 100k Ω pull-up resistor from the HP pin to V_{DD} and a 10k Ω pull-down resistor from the jack's audio signal pin to ground of the jack signal pin to which the wiper is connected. See the block diagrams on page 7 and page 8.

When no headphone plug is inserted into the jack, the voltage at the HP pin gets set at a low voltage level due to the 10k Ω resistor and 100k Ω resistor divider network connection to V_{DD} .

When a headphone is inserted into the jack, the 10k Ω resistor gets disconnected from the HP control pin and the HP pin gets pulled up to V_{DD} . Since the HP pin is now high, the headphone drivers are activated.

A microprocessor or a switch can be used to drive the HP pin rather than using the headphone jack contact pin.

Note: With a logic “1” at the HO pin, the BTL driver remains active regardless of the voltage level at the HD pin. This allows a headphone to be plugged into the headphone jack without activating the HP drivers. Music will continue to play through the internal 8 Ω speaker rather than the headphones.

Low Power Shutdown

With a logic “1” at the SD control pin the device enters the low power shutdown state. When in shutdown the BTL and headphone amplifiers go into an high impedance state and I_{DD} supply current is reduced to 26µA (typ).

In shutdown mode before the amplifiers enter the high impedance/low current drive state, the bias voltage of V_{DD}/2 remains connected at the output of the amplifiers through a 100kΩ resistor.

This resistor is not present during active operation of the drivers but gets switched in when the SD pin goes high. It gets removed when the SD pin goes low.

Leaving the DC bias voltage connected through a 100kΩ resistor while going into and out of shutdown reduces the transient at the speakers to a small level preventing clicking or popping in the speakers.

Note: When the SD pin is High it over-rides all other logic pins.

QFN Thermal Pad Considerations

The QFN package features an exposed thermal pad on its underside. This pad lowers the package’s thermal resistance by providing a direct heat conduction path from the die to the PCB. Connect the exposed thermal pad to GND by using a large copper pad and multiple vias to the GND plane. The vias should be plugged and tented with plating and solder mask to ensure good thermal conductivity.

Best thermal performance is achieved with the largest practical copper ground plane area.

PCB Layout Considerations and Power Supply Bypassing

To maintain the highest load dissipation and widest output voltage swing, the power supply PCB traces and the traces that connect the output of the drivers to the speaker loads should be made as wide as possible to minimize losses due to parasitic trace resistance.

Proper supply bypassing is necessary for high power supply rejection and low noise performance. A filter network consisting of a 10µF capacitor in parallel with a 0.1µF capacitor is recommended at the voltage regulator that is providing the power to the ISL54003, ISL54004, ISL54006 IC.

Local bypass capacitors of 0.1µF should be put at each VDD pin of the ISL54003, ISL54004, ISL54006 devices. They should be located as close as possible to the pin, keeping the length of leads and traces as short as possible.

A 1µF capacitor from the REF pin (pin 10) to ground is needed for optimum PSRR and internal bias voltage stability.

Typical Performance Curves T_A = +25°C, Unless Otherwise Specified.

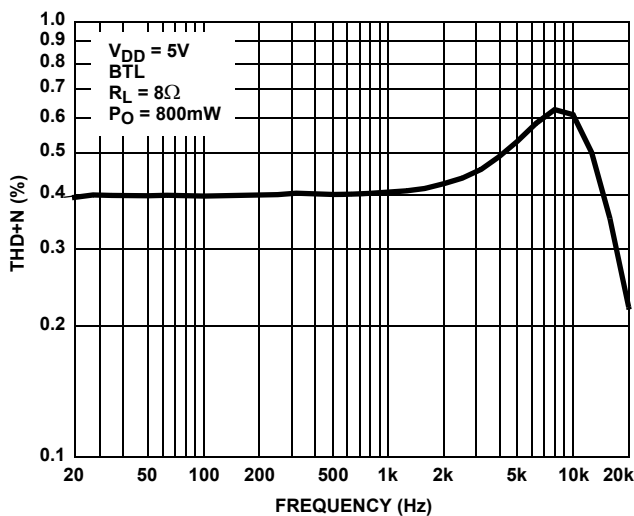

FIGURE 1. THD+N vs FREQUENCY

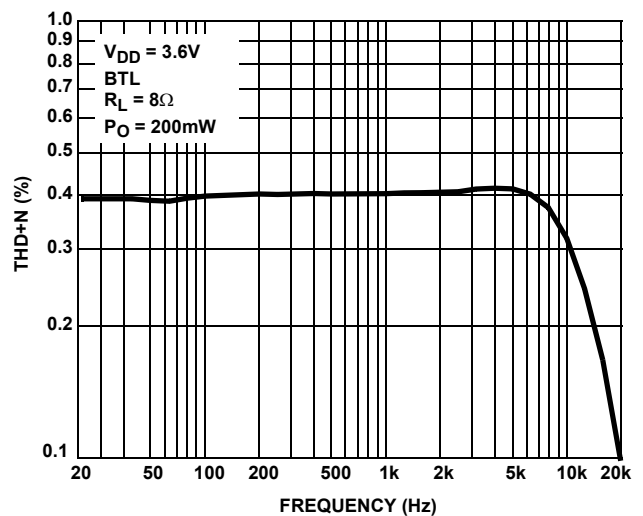

FIGURE 2. THD+N vs FREQUENCY

Typical Performance Curves $T_A = +25^\circ\text{C}$, Unless Otherwise Specified. (Continued)

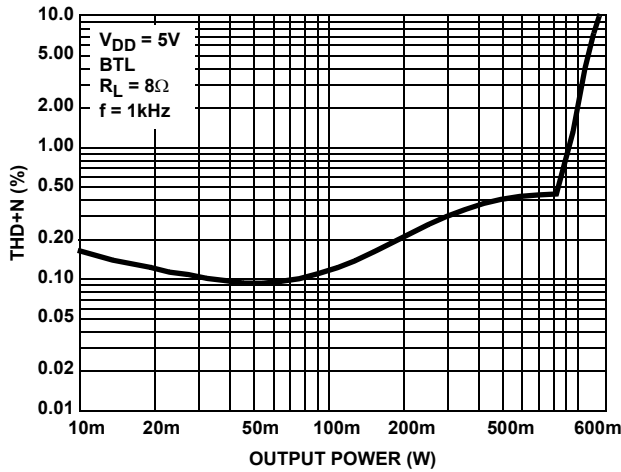

FIGURE 3. THD+N vs OUTPUT POWER

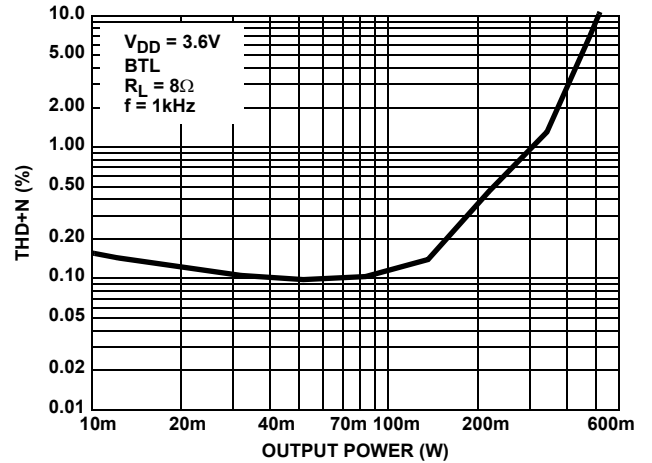

FIGURE 4. THD+N vs OUTPUT POWER

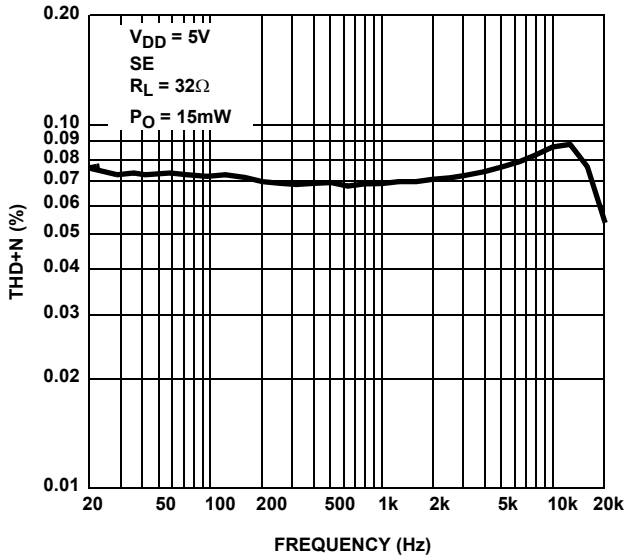

FIGURE 5. THD+N vs FREQUENCY

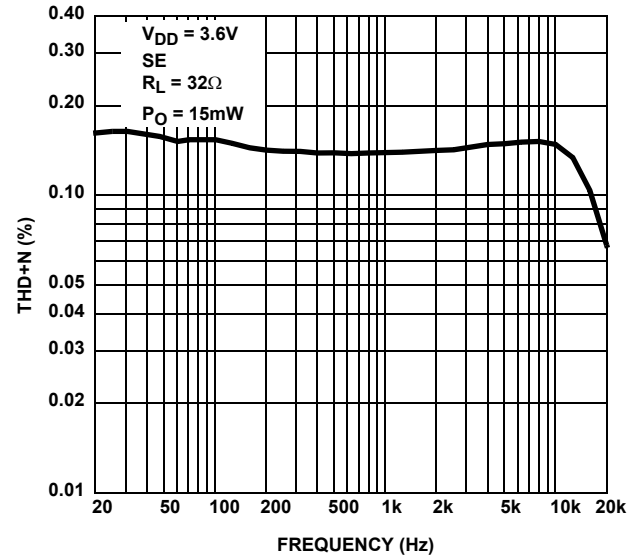

FIGURE 6. THD+N vs FREQUENCY

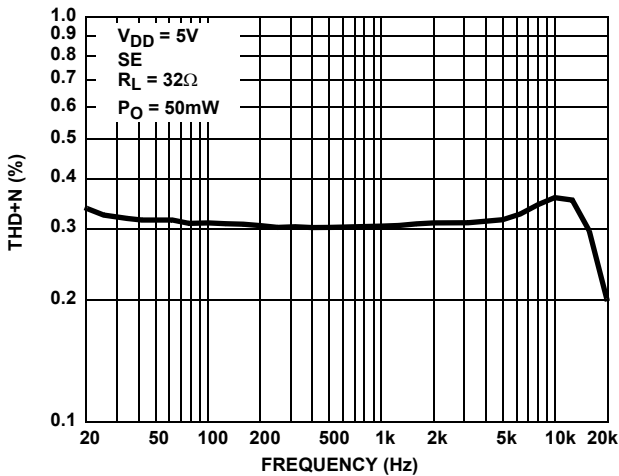

FIGURE 7. THD+N vs FREQUENCY

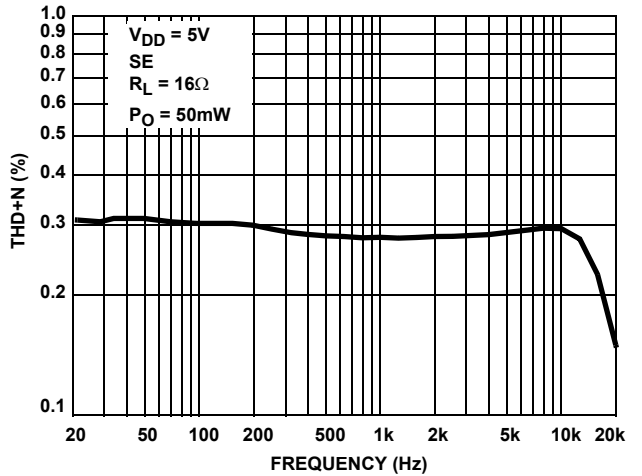

FIGURE 8. THD+N vs FREQUENCY

Typical Performance Curves $T_A = +25^\circ\text{C}$, Unless Otherwise Specified. (Continued)

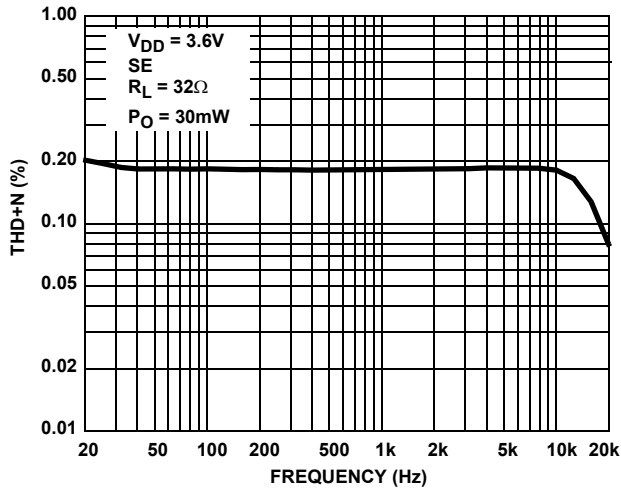

FIGURE 9. THD+N vs FREQUENCY

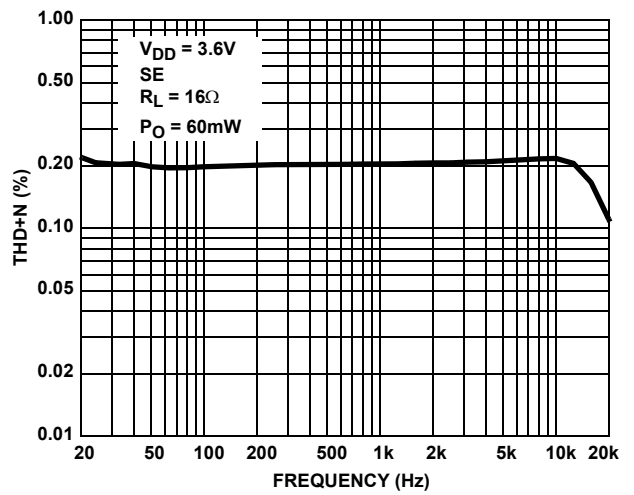

FIGURE 10. THD+N vs FREQUENCY

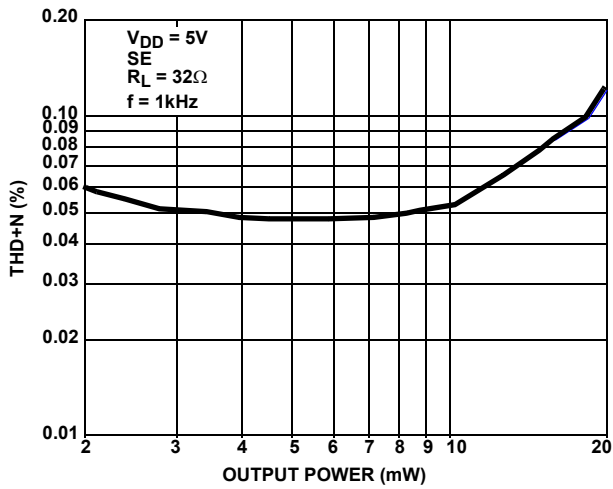

FIGURE 11. THD+N vs OUTPUT POWER

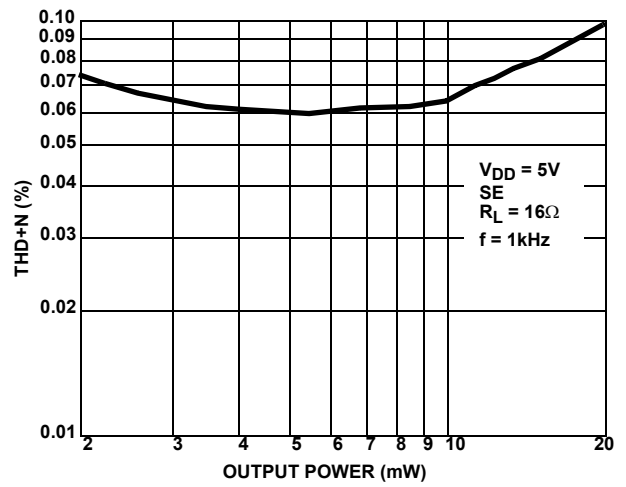

FIGURE 12. THD+N vs OUTPUT POWER

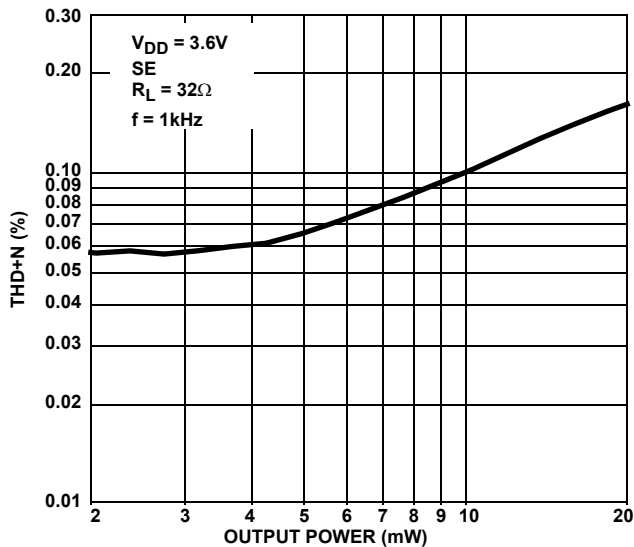

FIGURE 13. THD+N vs OUTPUT POWER

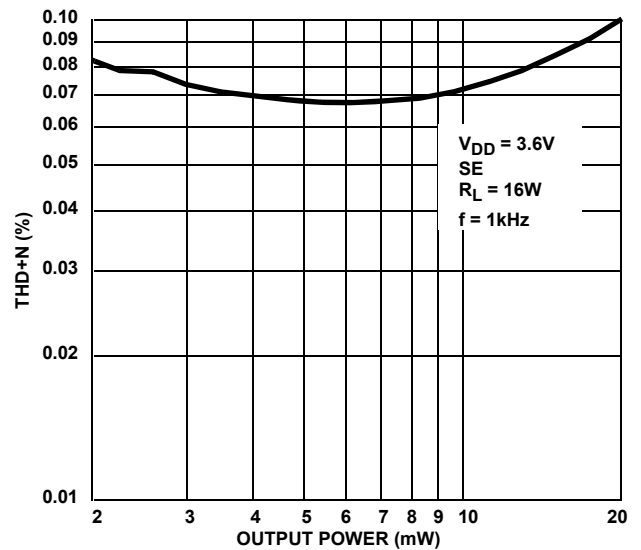

FIGURE 14. THD+N vs OUTPUT POWER

Typical Performance Curves $T_A = +25^\circ\text{C}$, Unless Otherwise Specified. (Continued)

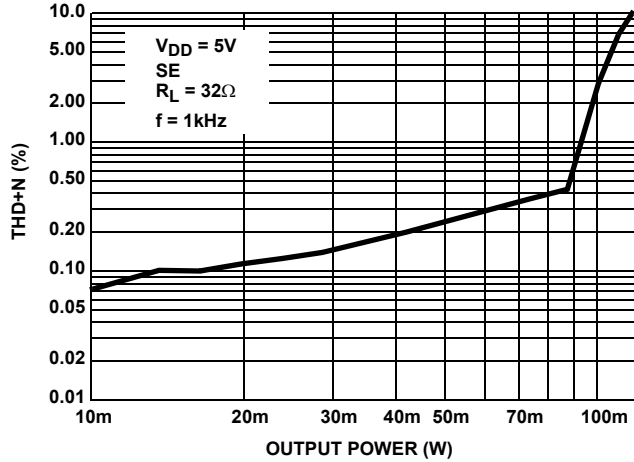

FIGURE 15. THD+N vs OUTPUT POWER

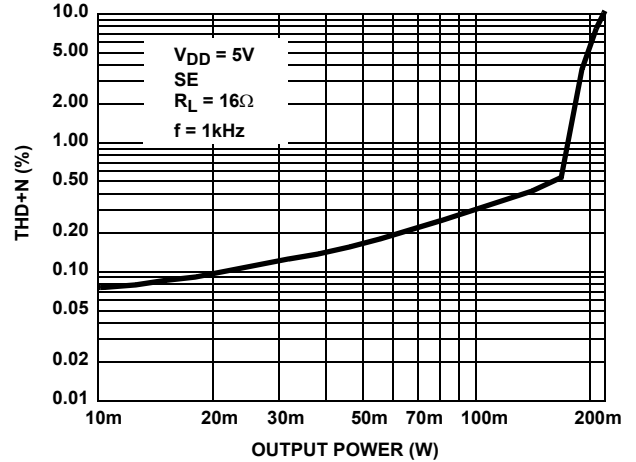

FIGURE 16. THD+N vs OUTPUT POWER

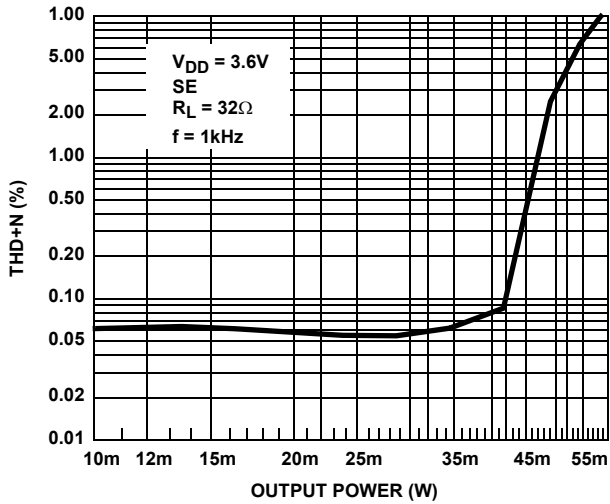

FIGURE 17. THD+N vs OUTPUT POWER

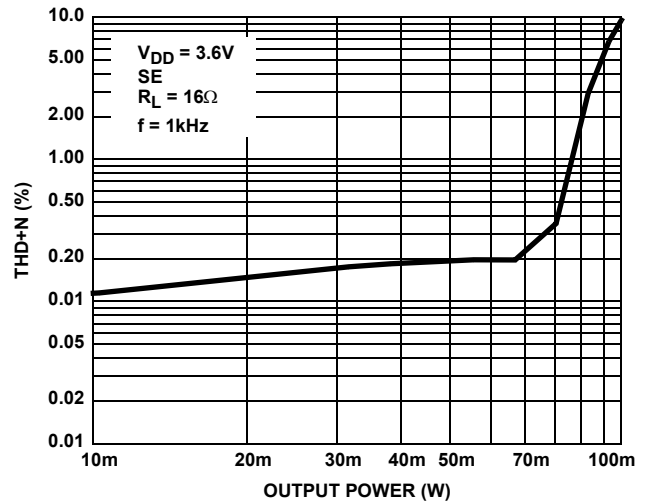

FIGURE 18. THD+N vs OUTPUT POWER

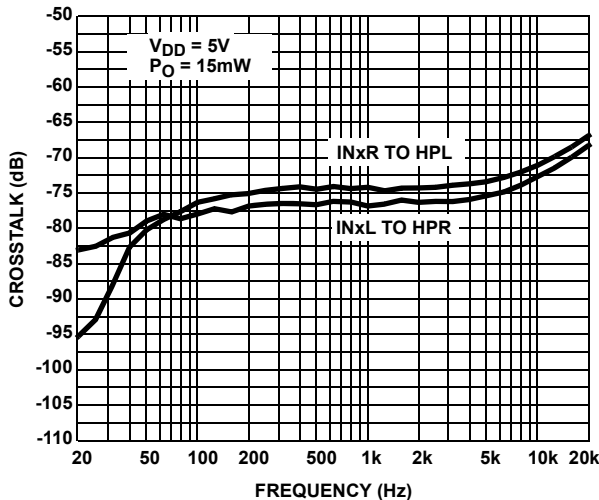

FIGURE 19. Crosstalk vs Frequency

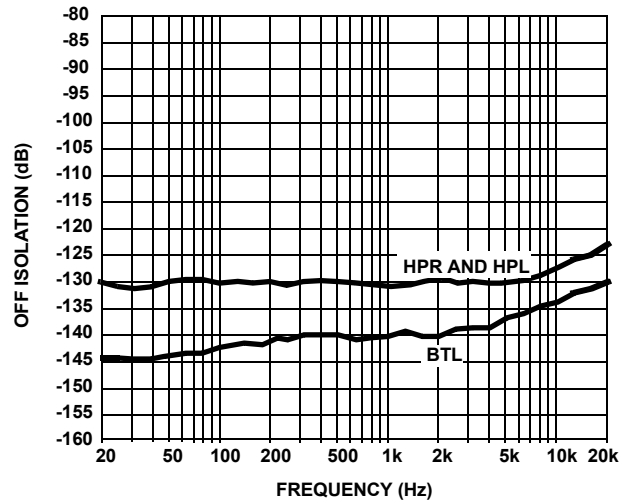

FIGURE 20. Off Isolation vs Frequency

Typical Performance Curves $T_A = +25^\circ\text{C}$, Unless Otherwise Specified. (Continued)

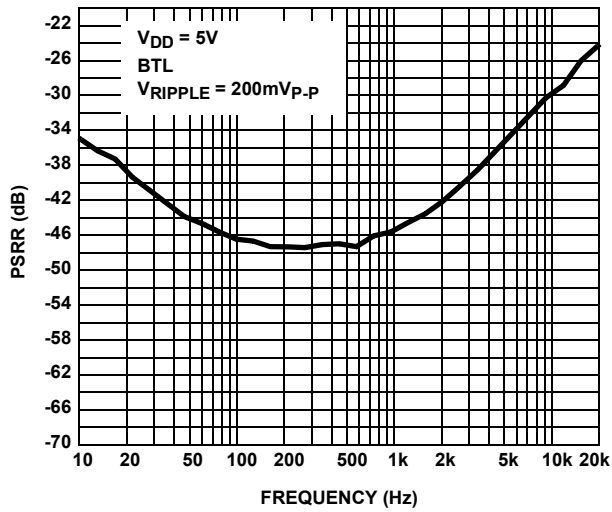

FIGURE 21. PSRR vs FREQUENCY

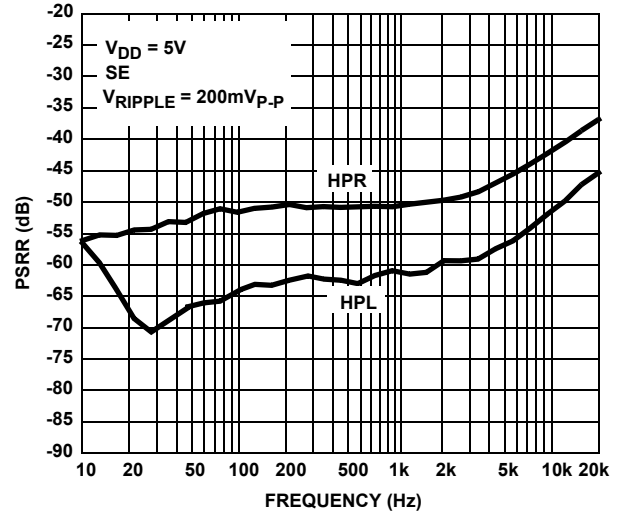

FIGURE 22. PSRR vs FREQUENCY

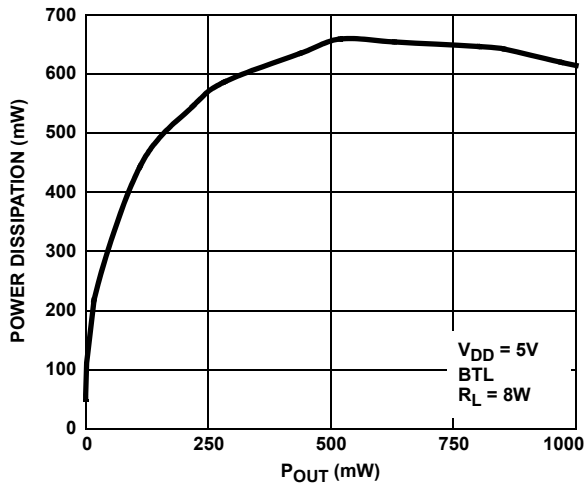

FIGURE 23. POWER DISSIPATION vs OUTPUT POWER

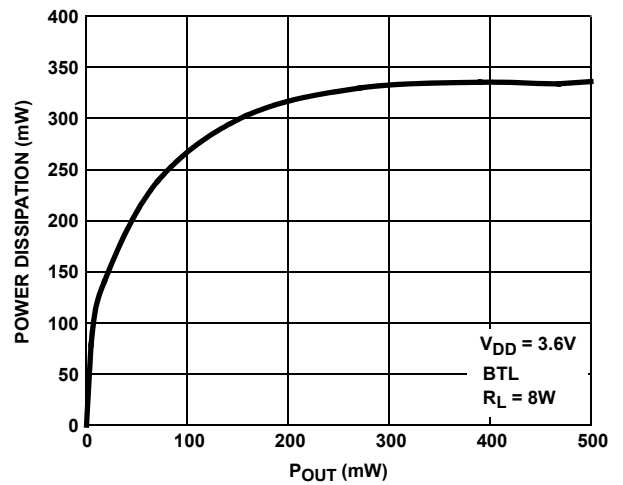

FIGURE 24. POWER DISSIPATION vs OUTPUT POWER

Die Characteristics

SUBSTRATE POTENTIAL (POWERED UP):

GND

PROCESS:

Submicron CMOS

Thin Quad Flat No-Lead Plastic Package (TQFN)
Thin Micro Lead Frame Plastic Package (TMLFP)

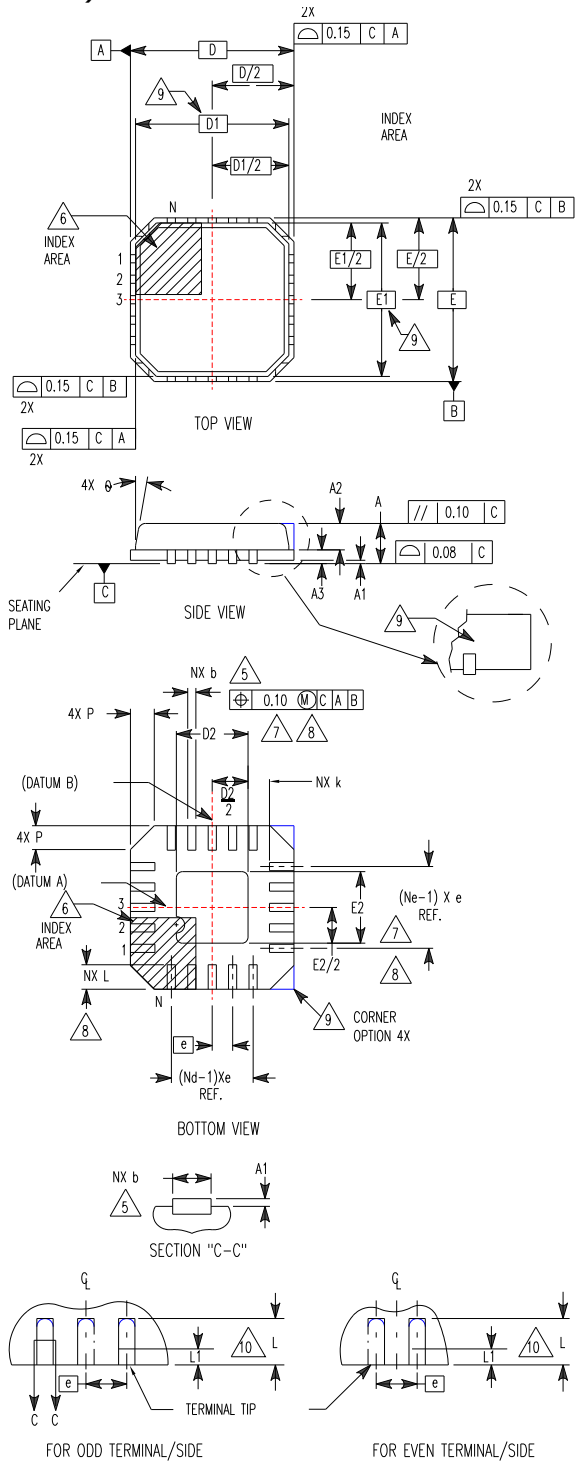

L20.4x4A

20 LEAD QUAD FLAT NO-LEAD PLASTIC PACKAGE
 (COMPLIANT TO JEDEC MO-220WGGD-1 ISSUE I)

SYMBOL	MILLIMETERS			NOTES
	MIN	NOMINAL	MAX	
A	0.70	0.75	0.80	-
A1	-	0.02	0.05	-
A2	-	0.55	0.80	9
A3	0.20 REF			9
b	0.18	0.25	0.30	5, 8
D	4.00 BSC			-
D1	3.75 BSC			9
D2	1.95	2.10	2.25	7, 8
E	4.00 BSC			-
E1	3.75 BSC			9
E2	1.95	2.10	2.25	7, 8
e	0.50 BSC			-
k	0.20	-	-	-
L	0.35	0.60	0.75	8
N	20			2
Nd	5			3
Ne	5			3
P	-	-	0.60	9
θ	-	-	12	9

Rev. 0 11/04

NOTES:

1. Dimensioning and tolerancing conform to ASME Y14.5-1994.
2. N is the number of terminals.
3. Nd and Ne refer to the number of terminals on each D and E.
4. All dimensions are in millimeters. Angles are in degrees.
5. Dimension b applies to the metallized terminal and is measured between 0.15mm and 0.30mm from the terminal tip.
6. The configuration of the pin #1 identifier is optional, but must be located within the zone indicated. The pin #1 identifier may be either a mold or mark feature.
7. Dimensions D2 and E2 are for the exposed pads which provide improved electrical and thermal performance.
8. Nominal dimensions are provided to assist with PCB Land Pattern Design efforts, see Intersil Technical Brief TB389.
9. Features and dimensions A2, A3, D1, E1, P & θ are present when Anvil singulation method is used and not present for saw singulation.

© Copyright Intersil Americas LLC 2007. All Rights Reserved.
All trademarks and registered trademarks are the property of their respective owners.

For additional products, see www.intersil.com/en/products.html

Intersil products are manufactured, assembled and tested utilizing ISO9001 quality systems as noted in the quality certifications found at www.intersil.com/en/support/qualandreliability.html

Intersil products are sold by description only. Intersil may modify the circuit design and/or specifications of products at any time without notice, provided that such modification does not, in Intersil's sole judgment, affect the form, fit or function of the product. Accordingly, the reader is cautioned to verify that datasheets are current before placing orders. Information furnished by Intersil is believed to be accurate and reliable. However, no responsibility is assumed by Intersil or its subsidiaries for its use; nor for any infringements of patents or other rights of third parties which may result from its use. No license is granted by implication or otherwise under any patent or patent rights of Intersil or its subsidiaries.

For information regarding Intersil Corporation and its products, see www.intersil.com