

ISL29006, ISL29007, ISL29008

Small, Low Power, Current-Output Ambient Light Photo Detect IC

FN6282
Rev 2.00
October 8, 2015

The ISL29006, ISL29007, and ISL29008 are light-to-current silicon optical sensors combining a photodiode array and a current amplifier on a single monolithic IC. The photodiode's spectral sensitivity approximates the human eye response peaking at 550nm with virtually no infrared (IR) response.

Exposed to light, these light sensors give current outputs that are linearly proportional to the light intensity. The output of ISL29006 is configured as a current source, and the output of ISL29007 is configured as a current sink. Both ISL29006 and ISL29007 offer an EN pin that can be used for a polling scheme to extend the battery life of portable devices.

The ISL29008 has dual outputs simultaneously sinking and sourcing current. With output currents at opposite polarity, it can simultaneously control two light sources/drivers that have incongruent illumination requirement depending on ambient light conditions. For example, at bright ambient light levels, display backpanels need more intensity while the keyboard illumination needs to be dimmer, whereas at darker ambient light levels, display backpanels need less intensity while the keyboard illumination needs to be brighter.

By connecting an external resistor from ISRC to GND or from ISNK to VDD, the current output can be converted into voltage output.

Housed in an ultra-compact 2mmx2.1mm ODFN clear plastic package, this device is excellent for power saving control function in cell phones, PDAs and other handheld applications.

Features

- 0.5 lux to 10,000 lux range
- 1.8V to 3.6V supply range
- Low supply current (3.5µA @ 100 lux)
- Fast response time
- Close to human eye response
- IR Rejection
- Internal dark current compensation
- Lux to current source or/and sink
- Excellent output linearity of luminance
- 6 Ld ODFN: 2mmx2.1mmx0.7mm
- Pb-free (RoHS compliant)

Applications

- Display and keypad dimming for:
 - Mobile devices: smart phone, PDA, GPS
 - Computing devices: notebook PC, webpod
 - Consumer devices: LCD-TV, digital picture frame, digital camera
- Industrial and medical light sensing

Ordering Information

PART NUMBER (Note)	TEMP. RANGE (°C)	PACKAGE (Pb-free)	PKG. DWG. #
ISL29006IROZ-T7*	-40 to +85	6 Ld ODFN	L6.2x2.1
ISL29007IROZ-T7* (No longer available or supported)	-40 to +85	6 Ld ODFN	L6.2x2.1
ISL29008IROZ-T7* (No longer available or supported)	-40 to +85	6 Ld ODFN	L6.2x2.1
ISL29006IROZ-EVALZ	Evaluation Board		

*Please refer to TB347 for details on reel specifications.

NOTE: These Intersil Pb-free plastic packaged products employ special Pb-free material sets; molding compounds/die attach materials and 100% matte tin plate - e3 termination finish, which is RoHS compliant and compatible with both SnPb and Pb-free soldering operations. Intersil Pb-free products are MSL classified at Pb-free peak reflow temperatures that meet or exceed the Pb-free requirements of IPC/JEDEC J STD-020.

Pinouts

ISL29006
(6 LD ODFN)
TOP VIEW

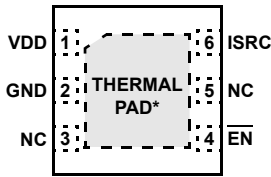

ISL29007
(6 LD ODFN)
TOP VIEW

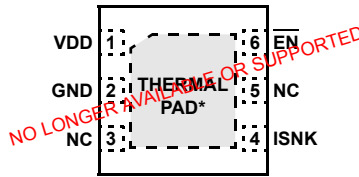

ISL29008
(6 LD ODFN)
TOP VIEW

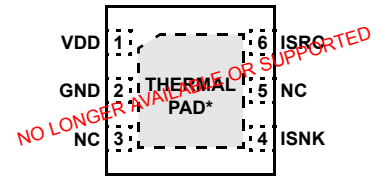

Pin Descriptions

ISL29006 PIN NUMBER	ISL29007 PIN NUMBER	ISL29008 PIN NUMBER	NAME	DESCRIPTION
1	1	1	VDD	Supply, 1.8V to 3.6V
2	2	2	GND	Ground
3, 5	3, 5	3, 5	NC	No connect
4	6		$\overline{\text{EN}}$	Active LOW enable
6		6	ISRC	Current source out
	4	4	ISNK	Current sink out

Simplified Block Diagrams

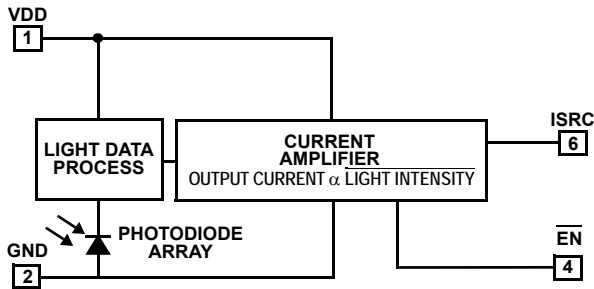

ISL29006

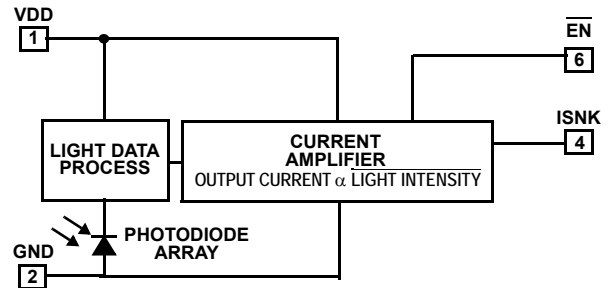

ISL29007

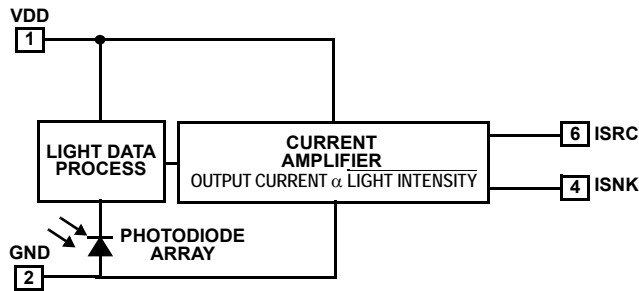

ISL29008

Absolute Maximum Ratings ($T_A = +25^\circ\text{C}$)

Supply Voltage between V_{DD} and GND	3.6V
Pin Voltage (ISRC, ISNK and EN)	-0.2V to 3.6V
Maximum Continuous Output Current	6mA
Operating Temperature	-40°C to +85°C
ESD Voltage	
Human Body Model	2kV
Machine Model	300V

Thermal Information

Thermal Resistance	θ_{JA} (°C/W)
6 Ld ODFN	90
Maximum Die Temperature	+90°C
Storage Temperature	-45°C to +100°C
Operating Temperature	-45°C to +85°C
Pb-Free Reflow Profile	see link below
	http://www.intersil.com/pbfree/Pb-FreeReflow.asp

CAUTION: Do not operate at or near the maximum ratings listed for extended periods of time. Exposure to such conditions may adversely impact product reliability and result in failures not covered by warranty.

IMPORTANT NOTE: All parameters having Min/Max specifications are guaranteed. Typical values are for information purposes only. Unless otherwise noted, all tests are at the specified temperature and are pulsed tests, therefore: $T_J = T_C = T_A$

Electrical Specifications $V_{DD} = 3V$, $T_A = +25^\circ\text{C}$, $R_L = 100k\Omega$, green LED light, unless otherwise specified.

PARAMETER	DESCRIPTION	CONDITION	MIN	TYP	MAX	UNIT
E	Range of Input Light Intensity			0.5 to 10k		lux
VDD	Power Supply Range		1.8		3.3	V
I _{DD}	Supply Current	E = 1000 lux		27	35	μA
		E = 100 lux		3.5		μA
		E = 0 lux		250		nA
I _{SRC1}	Light-to-Current Sourcing Accuracy	ISL29006 and ISL29008 E = 100 lux		1.65		μA
I _{SNK1}	Light-to-Current Sinking Accuracy	ISL29007 and ISL29008 E = 100 lux		1.65		μA
I _{SRC2}	Light-to-Current Sourcing Accuracy	ISL29006 and ISL29008 E = 1000 lux	11.5	16.45	21.3	μA
I _{SNK2}	Light-to-Current Sinking Accuracy	ISL29007 and ISL29008 E = 1000 lux	11.5	16.45	21.3	μA
I _{SNK} /I _{SRC}	Mismatch between I _{SNK} and I _{SRC}	E = 1000 lux for ISL29008	0.9	1.00	1.1	μA
I _{DARK}	Dark Current Output in the Absence of Light	E = 0 lux, $R_L = 10M\Omega$		0.22	2.5	μA
ΔI _{OUT}	Output Current Variation Over Three Light Sources: Fluorescent, Incandescent and Halogen	E = 1000 lux		20		%
I _{SD}	Supply Current when Shut Down				350	nA
V _{O-MAX1}	ISRC Max Output Compliance Voltage at 95% of Nominal Output	ISL29006 and ISL29008 E = 1000 lux		$V_{DD} - 0.2$		V
V _{O-MAX2}	ISNK Min Output Compliance Voltage at 95% of Nominal Output	ISL29007 and ISL29008 E = 1000 lux		0.2		V
t _R	ISRC and ISNK Rise Time (Note 1)	$R_L = 100k\Omega$, E = 300 lux from 0 Lux		104		μs
		$R_L = 100k\Omega$, E = 1000 lux from 0 Lux		27		μs
t _F	ISRC and ISNK Fall Time (Note 1)	$R_L = 100k\Omega$, E = 300 lux to 0 Lux		562		μs
		$R_L = 100k\Omega$, E = 1000 lux to 0 Lux		233		μs
t _D	ISRC and ISNK Delay Time for Rising Edge (Note 1)	$R_L = 100k\Omega$, E = 300 lux from 0 Lux		504		μs
		$R_L = 100k\Omega$, E = 1000 lux from 0 Lux		209		μs

Electrical Specifications $V_{DD} = 3V$, $T_A = +25^\circ C$, $R_L = 100k\Omega$, green LED light, unless otherwise specified. (Continued)

PARAMETER	DESCRIPTION	CONDITION	MIN	TYP	MAX	UNIT
t_S	ISRC and ISNK Delay Time for Falling Edge (Note 1)	$R_L = 100k\Omega$, $E = 300$ lux to 0 Lux		30		μs
		$R_L = 100k\Omega$, $E = 1000$ lux to 0 Lux		18		μs
V_{LO}	Maximum Voltage at \overline{EN} pin to Enable			0.5		V
V_{HI}	Minimum Voltage at \overline{EN} pin to Disable			$V_{DD} - 0.5$		V
I_{LO}	Input Current at \overline{EN} pin	$V_{\overline{EN}} = 0V$		1		nA
I_{HI}	Input Current at \overline{EN} pin	$V_{\overline{EN}} = 3V$		1		nA
t_{EN}	Enable Time	$R_L = 100k\Omega$, $E = 100$ lux		19		μs
t_{DIS}	Disable Time	$R_L = 100k\Omega$, $E = 100$ lux		202		μs

NOTE:

1. Switching time measurement is based on Figures 1 and 2.

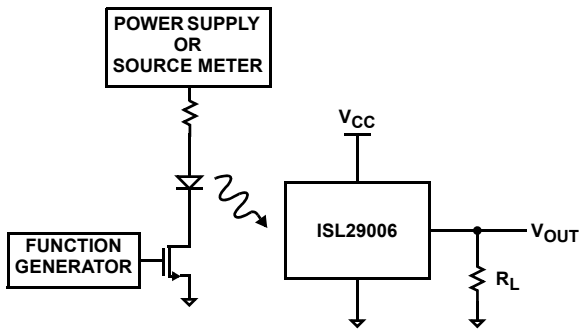

FIGURE 1. TEST CIRCUIT FOR RISE/FALL TIME MEASUREMENT

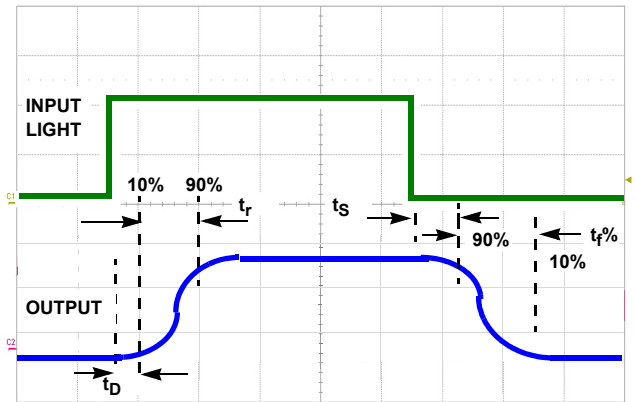

FIGURE 2. TIMING DIAGRAM

Typical Performance Curves

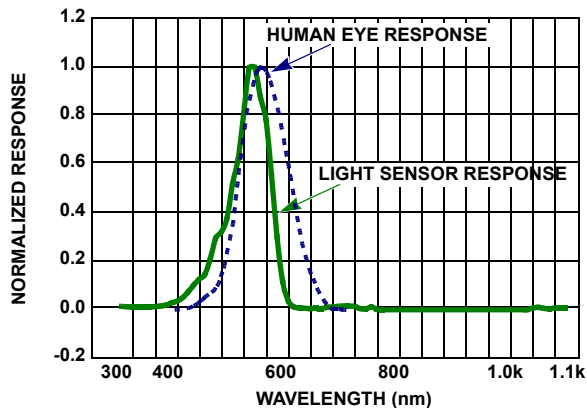

FIGURE 3. SPECTRAL RESPONSE

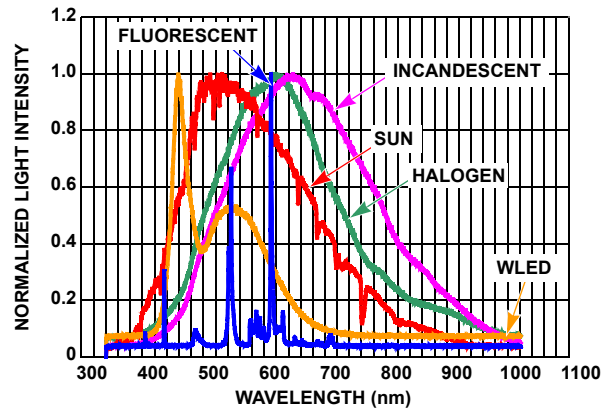

FIGURE 4. SPECTRUM OF LIGHT SOURCES

Typical Performance Curves (Continued)

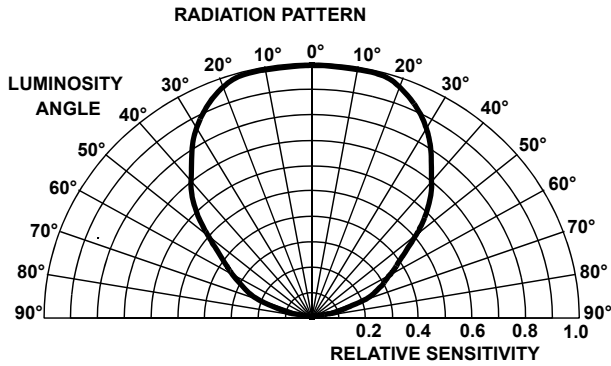

FIGURE 5. RADIATION PATTERN

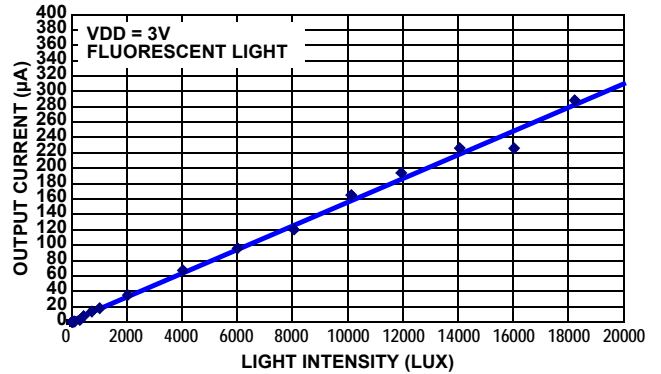

FIGURE 6. OUTPUT CURRENT vs LIGHT INTENSITY

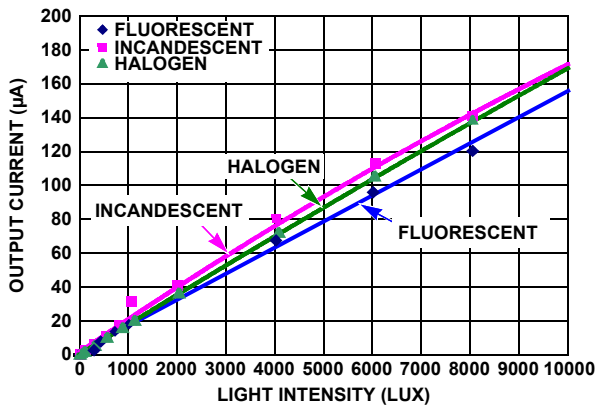

FIGURE 7. OUTPUT CURRENT vs LIGHT INTENSITY

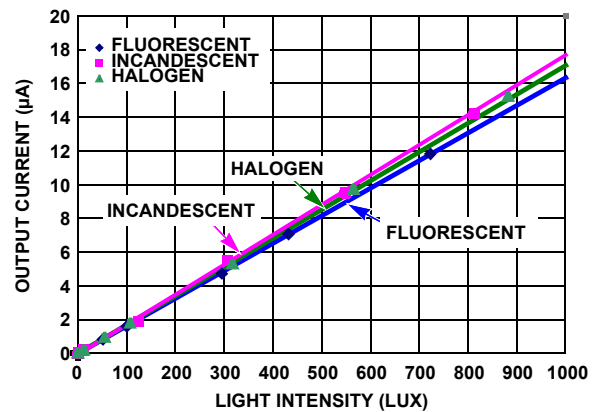

FIGURE 8. OUTPUT CURRENT vs LIGHT INTENSITY

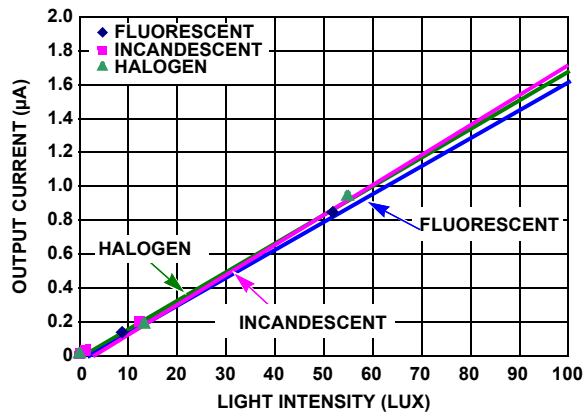

FIGURE 9. OUTPUT CURRENT vs LIGHT INTENSITY

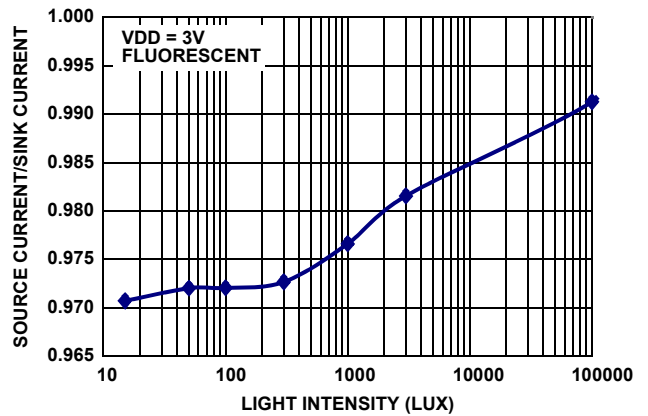

FIGURE 10. RATIO OF SOURCE CURRENT AND SINK CURRENT vs LIGHT INTENSITY

Typical Performance Curves (Continued)

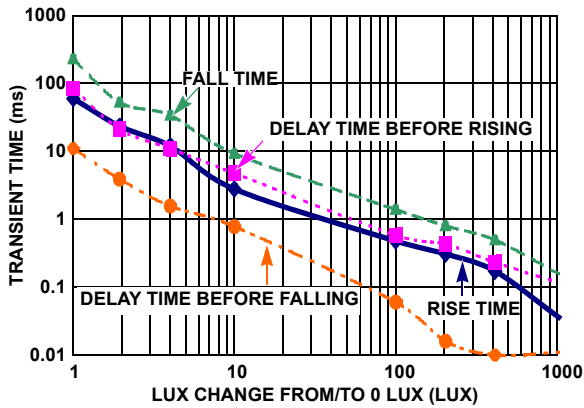

FIGURE 11. TRANSIENT TIME vs LUX CHANGE FROM/TO 0 LUX

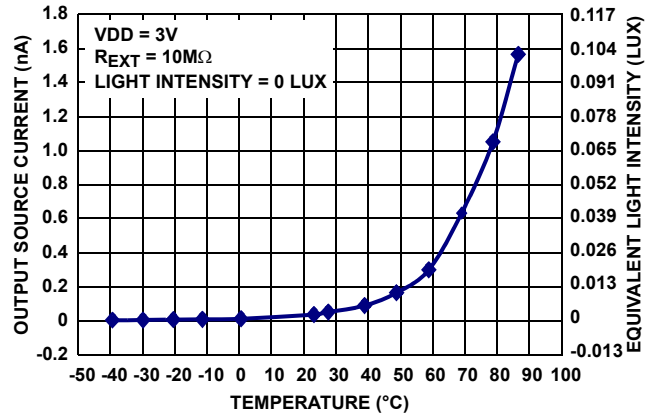

FIGURE 12. OUTPUT CURRENT vs TEMPERATURE AT 0 LUX

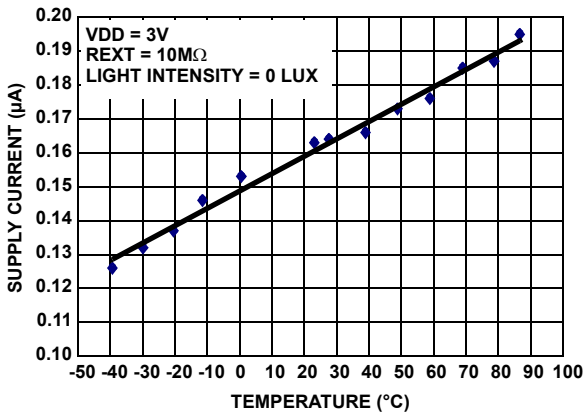

FIGURE 13. SUPPLY CURRENT vs TEMPERATURE AT 0 LUX

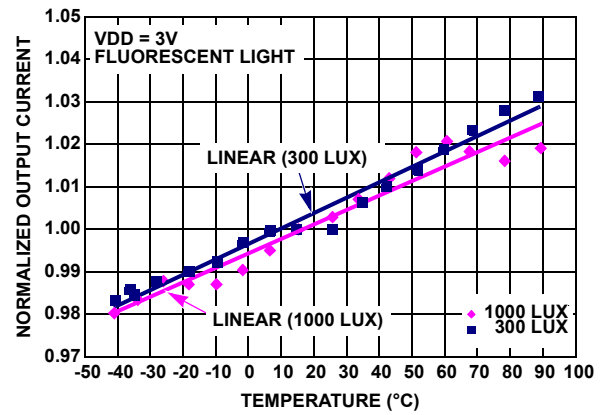

FIGURE 14. NORMALIZED OUTPUT CURRENT vs TEMPERATURE

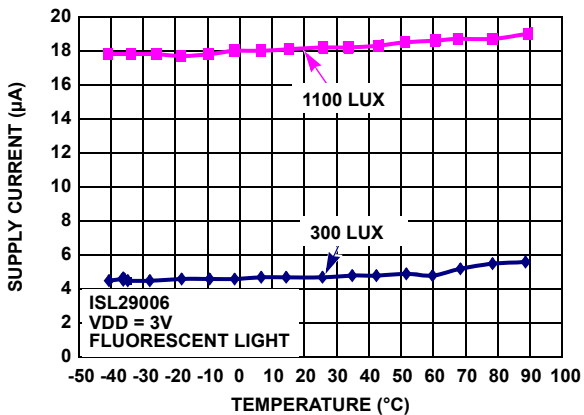

FIGURE 15. SUPPLY CURRENT vs TEMPERATURE

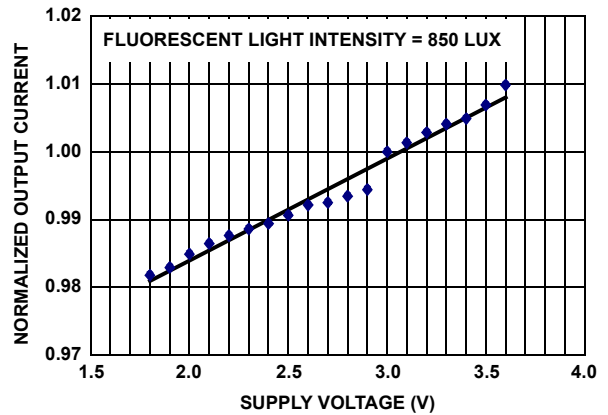

FIGURE 16. NORMALIZED OUTPUT CURRENT vs SUPPLY VOLTAGE

Typical Performance Curves (Continued)

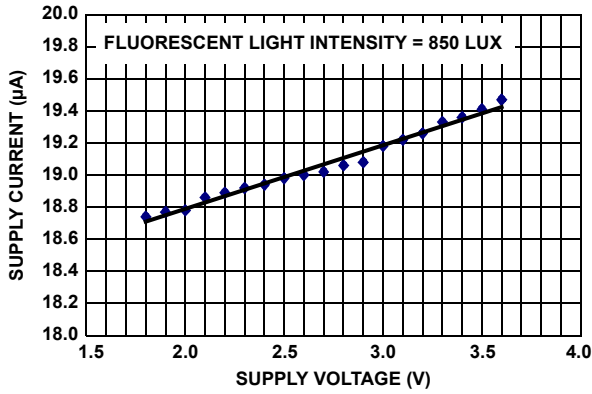

FIGURE 17. SUPPLY CURRENT vs SUPPLY VOLTAGE

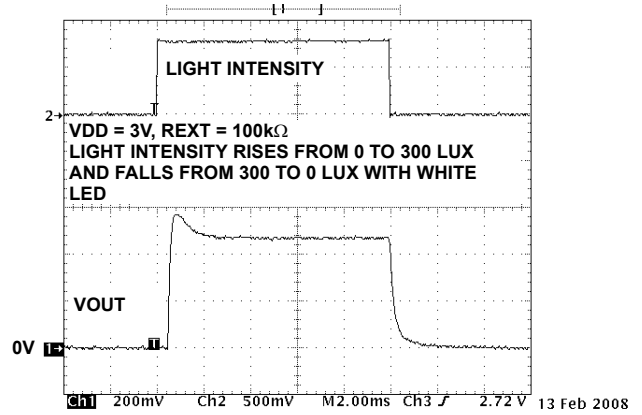

FIGURE 18. TRANSIENT RESPONSE OF ISL29006 TO CHANGE IN LIGHT INTENSITY

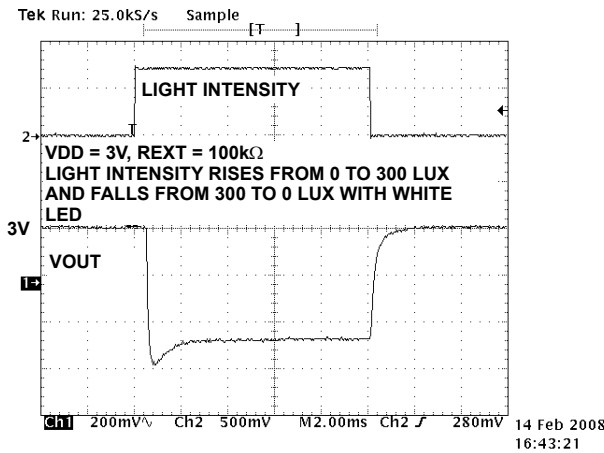

FIGURE 19. TRANSIENT RESPONSE OF ISL29007 TO CHANGE IN LIGHT INTENSITY

Application Information

Light-to-Current and Voltage Conversion

The ISL29006, ISL29007 and ISL29008 have responsiveness that is directly proportional to the intensity of light intercepted by the photodiode arrays. Conversion rate is independent of the light sources (fluorescent light, incandescent light or direct sunlight).

$$I_{OUT} = \left(\frac{1.6\mu A}{100\text{lux}} \right) \times E \quad (\text{EQ. 1})$$

Here, I_{OUT} is the output current in μA , and E is the input light in lux.

For some applications, a load resistor is added between the output and the ground, as shown in Figure 1. The output voltage can be expressed in Equation 2:

$$V_{OUT} = I_{OUT} \times R_L = \left(\frac{1.6\mu A}{100\text{lux}} \right) \times E \times R_L \quad (\text{EQ. 2})$$

Here, V_{OUT} is the output voltage and R_L is the value of the external load resistor. The compliance of the ISL29006's output circuit may result in premature saturation of the output current and voltage when an excessively large R_L is used. The output compliance voltage is 300mV below the supply voltage as listed in V_{O-MAX} of the "Electrical Specifications" table on page 3.

In order to have the linear relationship between the input light and the output current and voltage, a proper resistor value (i.e., gain) should be picked for a specific input light range. The resistor value can be picked according to Equation 3:

$$R_L = \frac{(V_{SUP} - 0.3V)}{1.6\mu A} \times \frac{100\text{lux}}{E_{RANGE}} \quad (\text{EQ. 3})$$

Here, V_{SUP} is the supply voltage and E_{RANGE} is the specific input light range for an application. For example, an indoor light ranges typically from 0 lux to 1,000 lux. A resistor value of 270k Ω for 3V supply voltage can be used. For a small light range, a large resistor value should be used to achieve better sensitivity; for a large light range, a small resistor value should be used to prevent non-linear output current and voltage.

Application Examples

The following examples present from fully automatic to fully manual override implementations. These guidelines are applicable to a wide variety of potential light control applications. The ISL29006, ISL29007 and ISL29008 can be used to control the brightness input of CCFL inverters. Likewise, it can interface well with LED drivers. In each specific application, it is important to recognize the target environment and its ambient light conditions. The mechanical mounting of the sensor, light aperture hole size and use of a light pipe or bezel are critical in determining the response of the ambient light detector for a given exposure of light.

The example in Figure 20 shows a fully automatic dimming solution with no user interaction. Choose R_1 and R_2 values for any desired minimum brightness and slope. Choose C_1 to adjust response time and to filter 50/60Hz room lighting. For example, suppose you wish to generate an output voltage from 0.25V to 1.2V to drive the input of an LED driver controller. The 0.25V represents the minimum LED brightness and 1.2V represents the maximum. The 1st step would be to determine the ratio of R_1 and R_2 in Equation 4:

$$R_1 = R_2 \times \left(\frac{3.0V}{0.25V} - 1 \right) = 11 \times R_2 \quad (\text{EQ. 4})$$

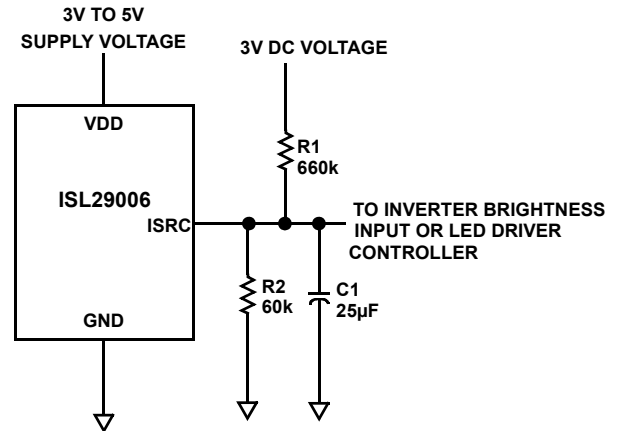

FIGURE 20.

Next, the value of R_2 can be calculated based on the maximum output current coming from the ISL29006 under the application's maximum light exposure. Suppose the current has been determined to be about 2 μA . Thus, R_2 can be approximately calculated using Equations 5 and 6:

$$R_2 = \left(\frac{1.2V}{2\mu A} \right) = 60k\Omega \quad (\text{EQ. 5})$$

and Equation 6:

$$R_1 = 11 \times R_2 = 660k\Omega \quad (\text{EQ. 6})$$

In Figure 20, the 3VDC supply can be replaced with a user adjustable bias control, such as 3V PWM control to allow control over the minimum and maximum output voltage.

Figure 21 shows that ISL29006 is used to provide automatic dimming control.

Short Circuit Current Limit

The ISL29006, ISL29007 and ISL29008 do not limit the output short circuit current. If the output is directly shorted to the ground continuously, the output current could easily increase for a strong input light such that the device may be damaged. Maximum reliability is maintained if the output continuous current never exceeds 6mA by adding a load resistor at the output. This limit is set by the design of the internal metal interconnects.

ISL29008 has the capability of both sourcing and sinking current simultaneously. It may replace ISL29006 in sourcing current applications, or ISL29007 in sinking current applications. In applications that require both sourcing and sinking currents, for example in cases of mobile phones or PDAs where the display brightness needs to be proportional to ambient brightness while the key pads need to be inversely proportional to the brightness, ISL29008 offers the most economical solution for cost and footprint.

Suggested PCB Footprint

Footprint pads should be a nominal 1-to-1 correspondence with package pads. Since ambient light sensor devices do not dissipate high power, heat dissipation through the exposed pad is not important; instead, similar to DFN or QFN, the exposed pad provides robustness in the board mounting process. Therefore, we recommend that the exposed pad be soldered down for robust joint formation, but this is not mandatory.

Power Supply Bypassing and Printed Circuit Board Layout

The ISL29006, ISL29007 and ISL29008 are relatively insensitive to the printed circuit board layout due to their low

speed operation. Nevertheless, good printed circuit board layout is necessary for optimum performance. Ground plane construction is highly recommended; lead length should be as short as possible and the power supply pins must be well bypassed to reduce the risk of oscillation. For normal single supply operation where the GND pin is connected to ground, a 0.1µF ceramic capacitor should be placed from the VCC pin to the GND pin. A 4.7µF tantalum capacitor should then be connected in parallel, placed close to the device.

Optical Sensor Location Outline

The green area in Figure 22 shows the optical sensor location outline of ISL29006, ISL29007 and ISL29008. Along the pin-out direction, the center line (CL) of the sensor coincides with that of the packaging. The sensor width in this direction is 0.39mm. Perpendicular to the pin-out direction, the CL of the sensor has a 0.19mm offset from the CL of packaging away from pin-1. The sensor width in this direction is 0.46mm.

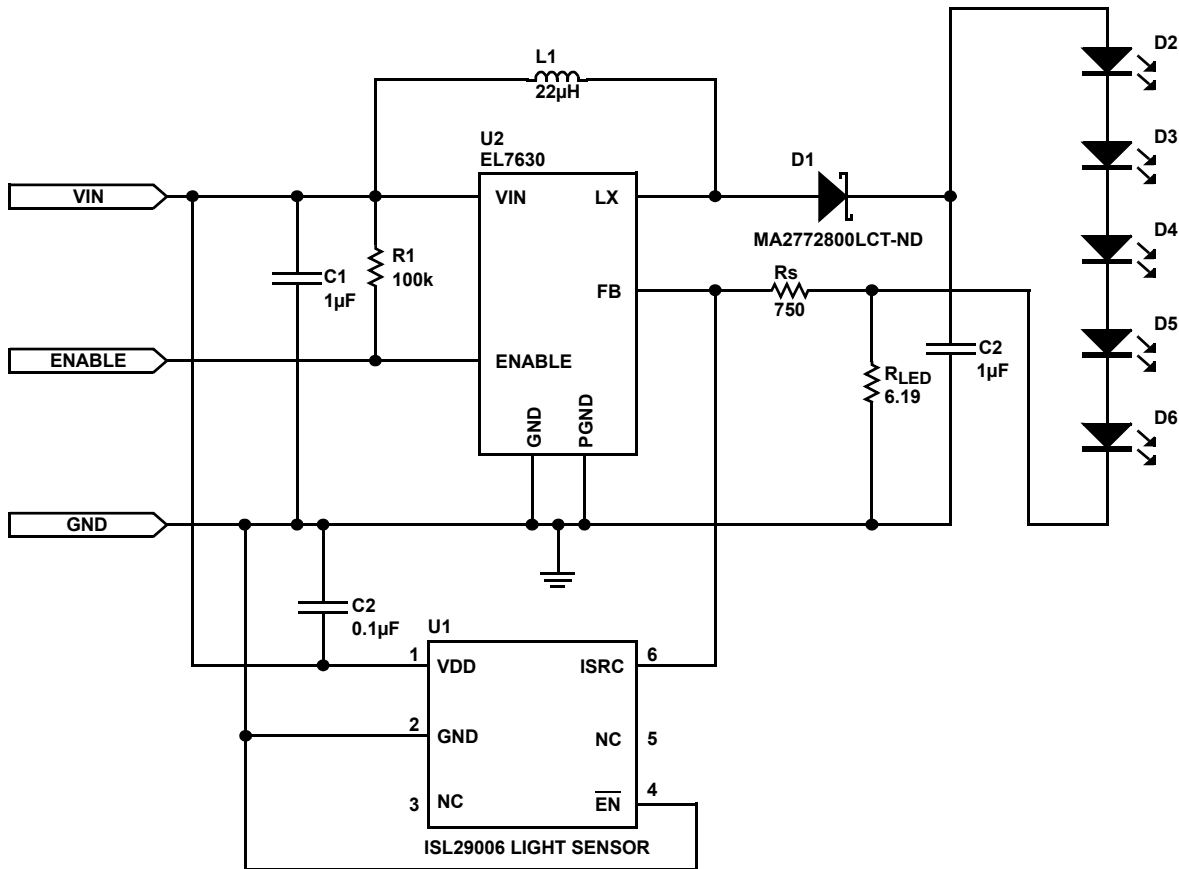

FIGURE 21. AUTOMATIC DIMMING CONTROL

$$I_{LED} = \frac{V_{FB}}{R_{LED}} - E \cdot \left(\frac{1.6\mu A}{100\text{lux}} \right) \cdot \left(\frac{R_s}{R_{LED}} + 1 \right) \quad (\text{EQ. 7})$$

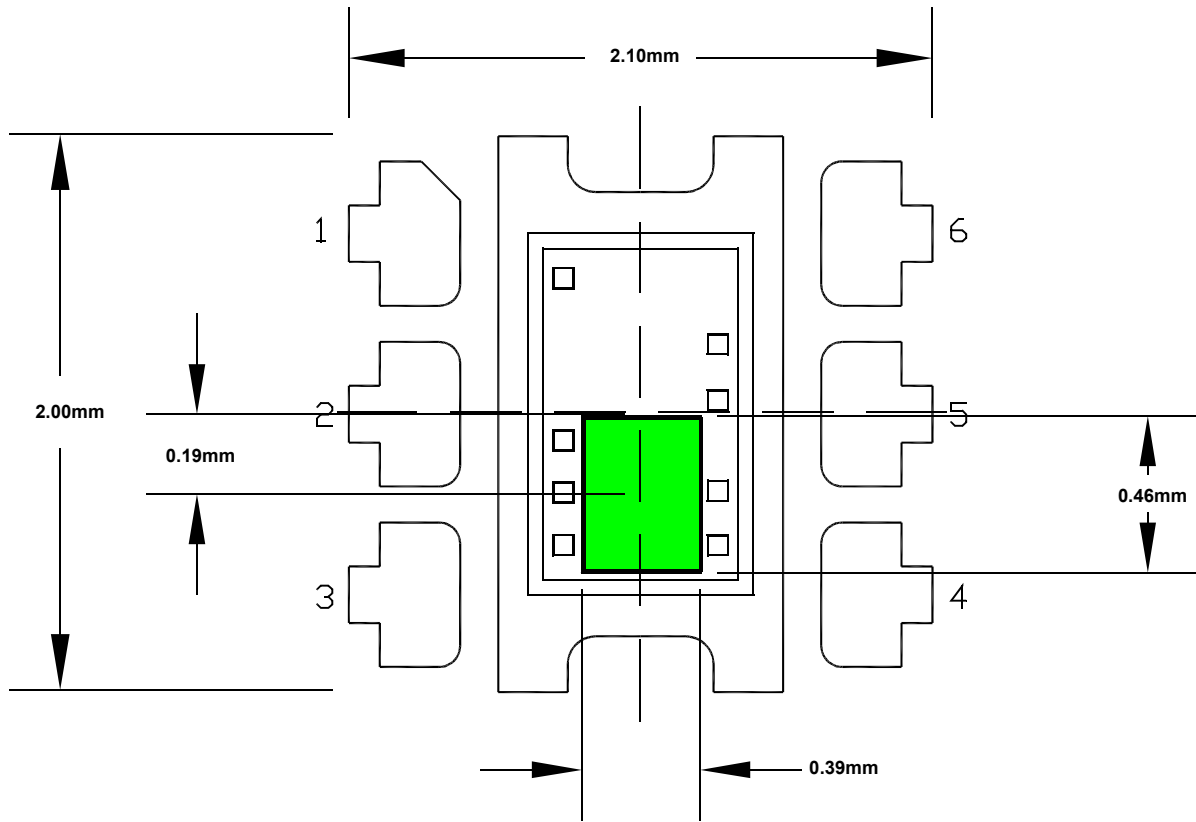

FIGURE 22. 6 LD ODFN SENSOR LOCATION OUTLINE

Revision History

The revision history provided is for informational purposes only and is believed to be accurate, but not warranted. Please go to the web to make sure that you have the latest revision.

DATE	REVISION	CHANGE
October 8, 2015	FN6282.2	<p>Added Rev History beginning with Rev 2. Added About Intersil Verbiage. Updated Ordering Information on page 1 Updated POD L6.2X2.1 to most current version. Revision changes are as follows: Changed Note 5 From: Tiebar shown (if present) is a non-functional feature. To: Tiebar shown (if present) is a non-functional feature and maybe located on any of the 4 sides (or ends). Added "MAX 0.75" dimension to Side View Added lead width of 6x0.30±0.05 and note 4 callout to bottom view Increased the size of the pin 1 shaded area Bottom View: Added dimension callouts for solder pad Land Pattern: Added package outline and package outline dimensions</p>

About Intersil

Intersil Corporation is a leading provider of innovative power management and precision analog solutions. The company's products address some of the largest markets within the industrial and infrastructure, mobile computing and high-end consumer markets.

For the most updated datasheet, application notes, related documentation and related parts, please see the respective product information page found at www.intersil.com.

You may report errors or suggestions for improving this datasheet by visiting www.intersil.com/ask.

Reliability reports are also available from our website at www.intersil.com/support

© Copyright Intersil Americas LLC 2008-2015. All Rights Reserved.
 All trademarks and registered trademarks are the property of their respective owners.

For additional products, see www.intersil.com/en/products.html

Intersil products are manufactured, assembled and tested utilizing ISO9001 quality systems as noted in the quality certifications found at www.intersil.com/en/support/qualandreliability.html

Intersil products are sold by description only. Intersil may modify the circuit design and/or specifications of products at any time without notice, provided that such modification does not, in Intersil's sole judgment, affect the form, fit or function of the product. Accordingly, the reader is cautioned to verify that datasheets are current before placing orders. Information furnished by Intersil is believed to be accurate and reliable. However, no responsibility is assumed by Intersil or its subsidiaries for its use; nor for any infringements of patents or other rights of third parties which may result from its use. No license is granted by implication or otherwise under any patent or patent rights of Intersil or its subsidiaries.

For information regarding Intersil Corporation and its products, see www.intersil.com

Package Outline Drawing

L6.2x2.1

6 LEAD OPTICAL DUAL FLAT NO-LEAD PLASTIC PACKAGE (ODFN)

Rev 4, 2/15

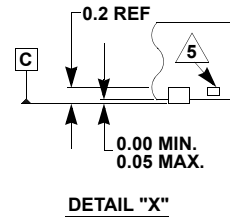
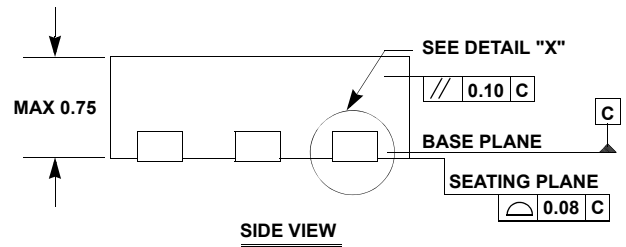
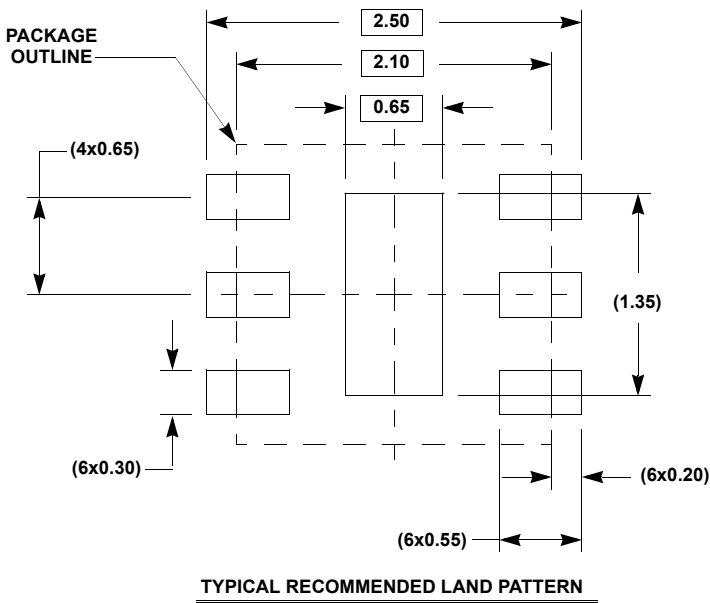
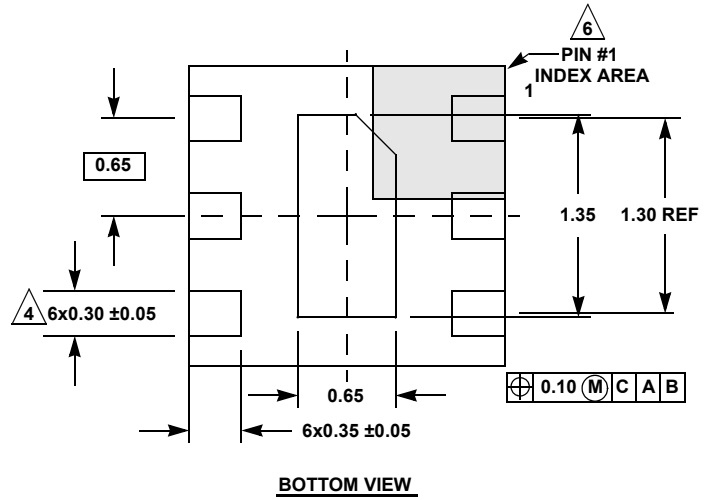
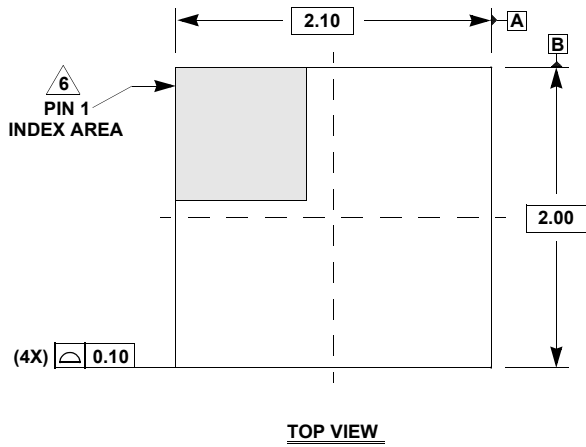

NOTES:

1. Dimensions are in millimeters.
Dimensions in () for Reference Only.
2. Dimensioning and tolerancing conform to ASME Y14.5m-1994.
3. Unless otherwise specified, tolerance: Decimal ± 0.05
4. Dimension applies to the metallized terminal and is measured between 0.15mm and 0.30mm from the terminal tip.
5. Tiebar shown (if present) is a non-functional feature and maybe located on any of the 4 sides (or ends).
6. The configuration of the pin #1 identifier is optional, but must be located within the zone indicated. The pin #1 identifier may be either a mold or mark feature.