

# IRGB4059DPbF

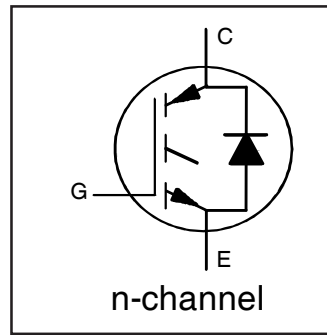
## INSULATED GATE BIPOLAR TRANSISTOR WITH ULTRAFAST SOFT RECOVERY DIODE

### Features

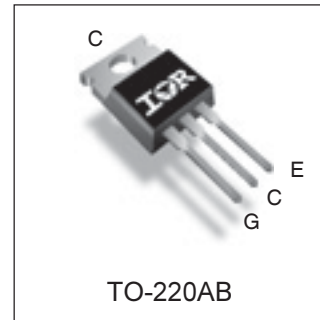
- Low  $V_{CE(on)}$  Trench IGBT Technology
- Low Switching Losses
- Maximum Junction temperature 175 °C
- 5 $\mu$ s SCSOA
- Square RBSOA
- 100% of The Parts Tested for 4X Rated Current ( $I_{LM}$ )
- Positive  $V_{CE(on)}$  Temperature Coefficient.
- Ultra Fast Soft Recovery Co-pak Diode
- Tighter Distribution of Parameters
- Lead-Free Package

### Benefits

- High Efficiency in a Wide Range of Applications
- Suitable for a Wide Range of Switching Frequencies due to Low  $V_{CE(ON)}$  and Low Switching Losses
- Rugged Transient Performance for Increased Reliability
- Excellent Current Sharing in Parallel Operation
- Low EMI



$V_{CES} = 600V$
$I_C = 4.0A, T_C = 100^\circ C$
$t_{sc} > 5\mu s, T_{jmax} = 175^\circ C$
$V_{CE(on) typ.} = 1.75V$



<b>G</b>	<b>C</b>	<b>E</b>
Gate	Collector	Emitter

### Absolute Maximum Ratings

	Parameter	Max.	Units
$V_{CES}$	Collector-to-Emitter Breakdown Voltage	600	V
$I_C @ T_C = 25^\circ C$	Continuous Collector Current	8	A
$I_C @ T_C = 100^\circ C$	Continuous Collector Current	4	
$I_{CM}$	Pulsed Collector Current	16	
$I_{LM}$	Clamped Inductive Load Current ①	16	
$I_F @ T_C = 25^\circ C$	Diode Continuous Forward Current	8	
$I_F @ T_C = 100^\circ C$	Diode Continuous Forward Current	4	
$I_{FM}$	Diode Maximum Forward Current ②	16	
$V_{GE}$	Continuous Gate-to-Emitter Voltage	$\pm 20$	V
	Transient Gate-to-Emitter Voltage	$\pm 30$	
$P_D @ T_C = 25^\circ$	Maximum Power Dissipation	56	W
$P_D @ T_C = 100^\circ$	Maximum Power Dissipation	28	
$T_J$ $T_{STG}$	Operating Junction and Storage Temperature Range	-55 to + 175	$^\circ C$
	Soldering Temperature, for 10 seconds	300 (0.063 in. (1.6mm) from case)	

### Thermal Resistance

	Parameter	Min.	Typ.	Max.	Units
$R_{\theta JC}$	Junction-to-Case - IGBT ③			2.70	$^\circ C/W$
$R_{\theta JC}$	Junction-to-Case - Diode ③			6.30	
$R_{\theta CS}$	Case-toSink, flat, greased surface		0.5		
$R_{\theta JA}$	Junction-to-Ambient, typical socket mount ③		80		
Wt	Weight		1.44		g

**Electrical Characteristics @ T<sub>J</sub> = 25°C (unless otherwise specified)**

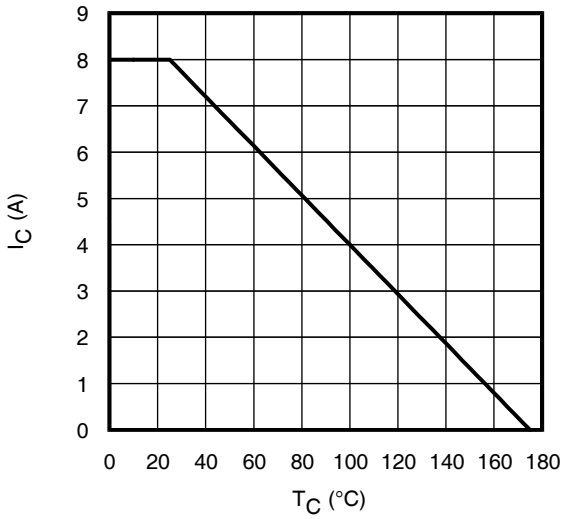
	Parameter	Min.	Typ.	Max.	Units	Conditions	Ref.Fig
V <sub>(BR)CES</sub>	Collector-to-Emitter Breakdown Voltage	600	—	—	V	V <sub>GE</sub> = 0V, I <sub>C</sub> = 100 μA ④	CT6
ΔV <sub>(BR)CES</sub> /ΔT <sub>J</sub>	Temperature Coeff. of Breakdown Voltage	—	0.3	—	V/°C	V <sub>GE</sub> = 0V, I <sub>C</sub> = 250 μA ( 25 -175 °C ) ④	
V <sub>CE(on)</sub>	Collector-to-Emitter Saturation Voltage	—	1.75	2.05		I <sub>C</sub> = 4A, V <sub>GE</sub> = 15V, T <sub>J</sub> = 25°C	5,6,7,9, 10,11
		—	2.15	—	V	I <sub>C</sub> = 4A, V <sub>GE</sub> = 15V, T <sub>J</sub> = 150°C	
		—	2.20	—		I <sub>C</sub> = 4A, V <sub>GE</sub> = 15V, T <sub>J</sub> = 175°C	
V <sub>GE(th)</sub>	Gate Threshold Voltage	4.0		6.5	V	V <sub>CE</sub> = V <sub>GE</sub> , I <sub>C</sub> = 100 μA	9,10,11,12
ΔV <sub>GE(th)</sub> /ΔT <sub>J</sub>	Threshold Voltage temp. coefficient	—	-18	—	mV/°C	V <sub>CE</sub> = V <sub>GE</sub> , I <sub>C</sub> = 250 μA ( 25 -175 °C )	
g <sub>fe</sub>	Forward Transconductance	—	2.0	—	S	V <sub>CE</sub> = 50V, I <sub>C</sub> = 4A, PW = 80μs	
I <sub>CES</sub>	Collector-to-Emitter Leakage Current	—	1	25	μA	V <sub>GE</sub> = 0V, V <sub>CE</sub> = 600V	8
		—	280	—	μA	V <sub>GE</sub> = 0V, V <sub>CE</sub> = 600V, T <sub>J</sub> = 175°C	
V <sub>FM</sub>	Diode Forward Voltage Drop	—	1.60	2.30	V	I <sub>F</sub> = 4A	
		—	1.30	—		I <sub>F</sub> = 4A, T <sub>J</sub> = 175°C	
I <sub>GES</sub>	Gate-to-Emitter Leakage Current	—	—	±100	nA	V <sub>GE</sub> = ± 20 V	

**Switching Characteristics @ T<sub>J</sub> = 25°C (unless otherwise specified)**

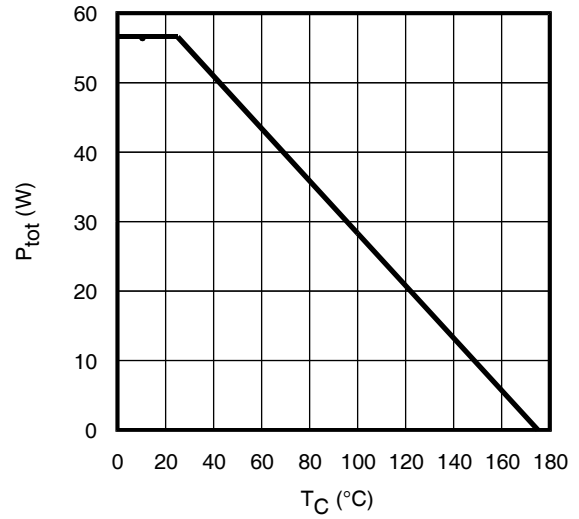
	Parameter	Min.	Typ.	Max.	Units	Conditions	Ref.Fig
Q <sub>g</sub>	Total Gate Charge (turn-on)	—	9	13	nC	I <sub>C</sub> = 4A V <sub>CC</sub> = 400V V <sub>GE</sub> = 15V	24
Q <sub>ge</sub>	Gate-to-Emitter Charge (turn-on)	—	2	3			CT1
Q <sub>gc</sub>	Gate-to-Collector Charge (turn-on)	—	4	6			
E <sub>on</sub>	Turn-On Switching Loss	—	35	77	μJ	I <sub>C</sub> = 4A, V <sub>CC</sub> = 400V, V <sub>GE</sub> = 15V R <sub>G</sub> = 100Ω, L = 1mH, L <sub>S</sub> = 150nH, T <sub>J</sub> = 25°C Energy losses include tail and diode reverse recovery	CT4
E <sub>off</sub>	Turn-Off Switching Loss	—	75	118			
E <sub>total</sub>	Total Switching Loss	—	110	196			
t <sub>d(on)</sub>	Turn-On delay time	—	25	33	ns	I <sub>C</sub> = 4A, V <sub>CC</sub> = 400V R <sub>G</sub> = 100Ω, L = 1mH, L <sub>S</sub> = 150nH T <sub>J</sub> = 25°C	CT4
t <sub>r</sub>	Rise time	—	10	14			
t <sub>d(off)</sub>	Turn-Off delay time	—	65	75			
t <sub>f</sub>	Fall time	—	15	20			
E <sub>on</sub>	Turn-On Switching Loss	—	90	—	μJ	I <sub>C</sub> = 4A, V <sub>CC</sub> = 400V, V <sub>GE</sub> = 15V R <sub>G</sub> = 100Ω, L = 1mH, L <sub>S</sub> = 150nH, T <sub>J</sub> = 175°C Energy losses include tail and diode reverse recovery	13,15
E <sub>off</sub>	Turn-Off Switching Loss	—	120	—			CT4
E <sub>total</sub>	Total Switching Loss	—	210	—			WF1,WF2
t <sub>d(on)</sub>	Turn-On delay time	—	20	—	ns	I <sub>C</sub> = 4A, V <sub>CC</sub> = 400V R <sub>G</sub> = 100Ω, L = 1mH, L <sub>S</sub> = 150nH T <sub>J</sub> = 175°C	14,16
t <sub>r</sub>	Rise time	—	15	—			CT4
t <sub>d(off)</sub>	Turn-Off delay time	—	85	—			WF1,WF2
t <sub>f</sub>	Fall time	—	35	—			
C <sub>ies</sub>	Input Capacitance	—	240	—	pF	V <sub>GE</sub> = 0V V <sub>CC</sub> = 30V f = 1Mhz	22
C <sub>oes</sub>	Output Capacitance	—	25	—			
C <sub>res</sub>	Reverse Transfer Capacitance	—	10	—			
RBSOA	Reverse Bias Safe Operating Area	FULL SQUARE				T <sub>J</sub> = 175°C, I <sub>C</sub> = 16A V <sub>CC</sub> = 480V, V <sub>p</sub> = 600V R <sub>G</sub> = 100Ω, V <sub>GE</sub> = +15V to 0V	4 CT2
SCSOA	Short Circuit Safe Operating Area	5			μs	V <sub>CC</sub> = 400V, V <sub>p</sub> = 600V R <sub>G</sub> = 100Ω, V <sub>GE</sub> = +15V to 0V	22, CT3 WF4
E <sub>rec</sub>	Reverse recovery energy of the diode		145		μJ	T <sub>J</sub> = 175°C	17,18,19
t <sub>rr</sub>	Diode Reverse recovery time		55		ns	V <sub>CC</sub> = 400V, I <sub>F</sub> = 4A	20,21
I <sub>rr</sub>	Peak Reverse Recovery Current		11		A	V <sub>GE</sub> = 15V, R <sub>G</sub> = 100Ω, L = 1mH, L <sub>S</sub> = 150nH	WF3

## Notes:

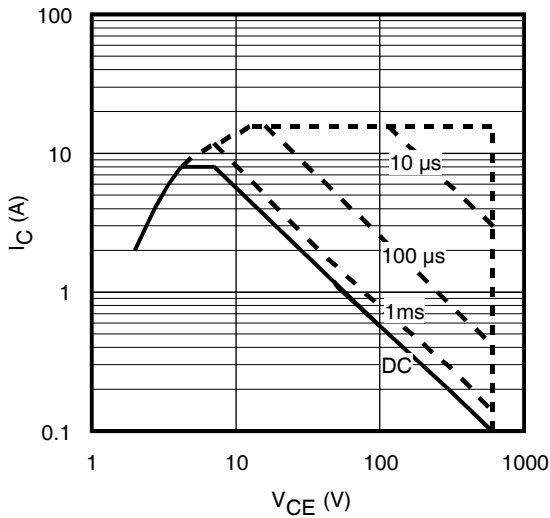
- ① V<sub>CC</sub> = 80% (V<sub>CES</sub>), V<sub>GE</sub> = 15V, L = 100 μH, R<sub>G</sub> = 100 Ω.
- ② Pulse width limited by max. junction temperature.
- ③ R<sub>θ</sub> is measured at T<sub>J</sub> approximately 90°C
- ④ Refer to AN-1086 for guide lines for measuring V<sub>(BR)CES</sub> safely



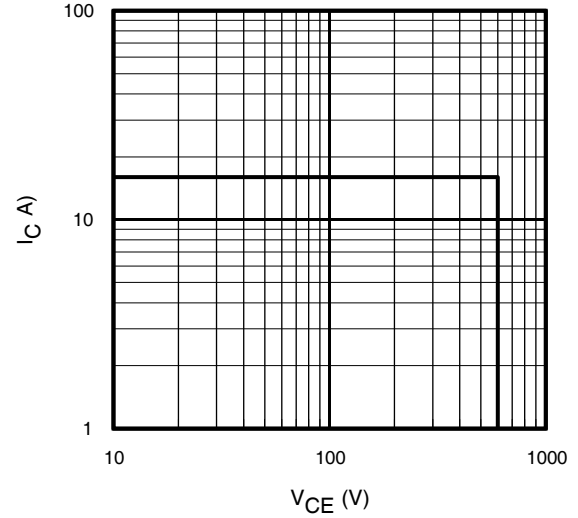
**Fig. 1** - Maximum DC Collector Current vs. Case Temperature



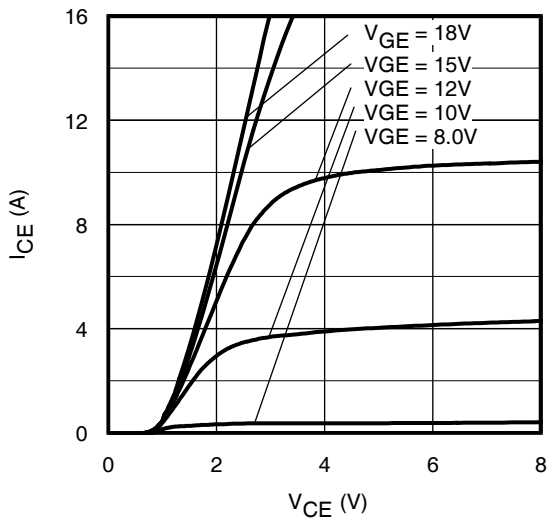
**Fig. 2** - Power Dissipation vs. Case Temperature



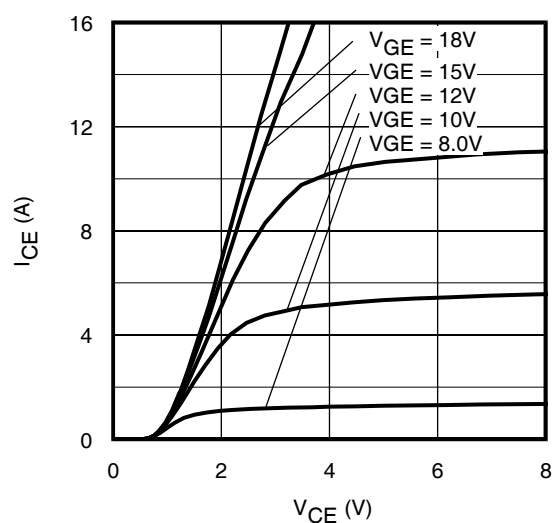
**Fig. 3** - Forward SOA,  
 $T_C = 25^{\circ}C$ ;  $T_J \leq 175^{\circ}C$



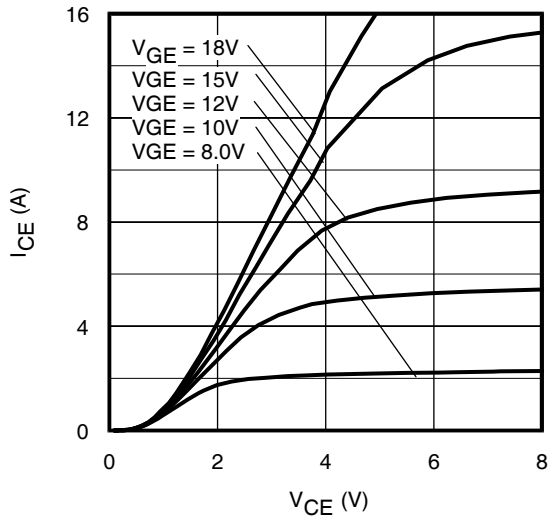
**Fig. 4** - Reverse Bias SOA  
 $T_J = 175^{\circ}C$ ;  $V_{CE} = 15V$



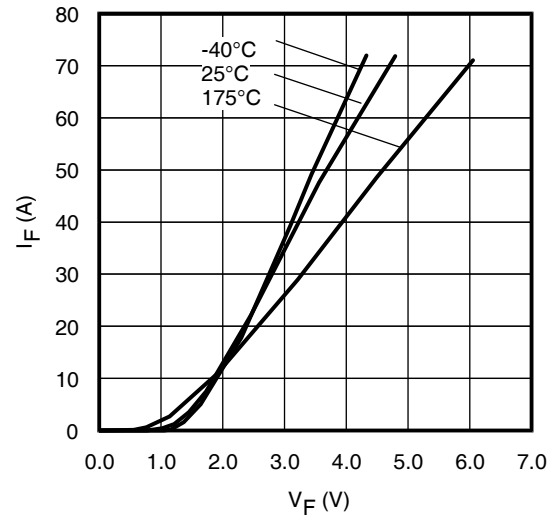
**Fig. 5** - Typ. IGBT Output Characteristics  
 $T_J = -40^{\circ}C$ ;  $t_p = 80\mu s$



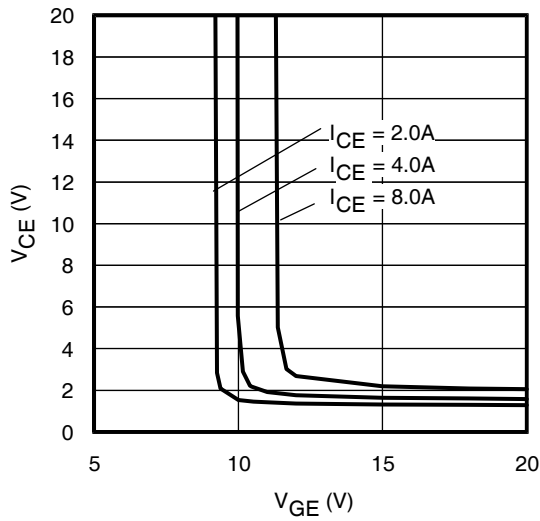
**Fig. 6** - Typ. IGBT Output Characteristics  
 $T_J = 25^{\circ}C$ ;  $t_p = 80\mu s$



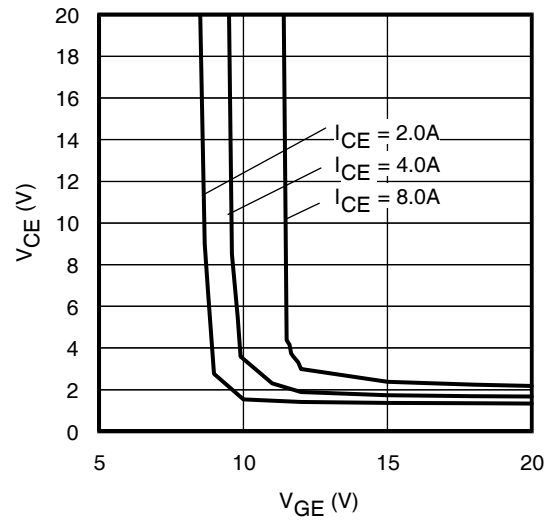
**Fig. 7** - Typ. IGBT Output Characteristics  
 $T_J = 175^\circ\text{C}$ ;  $t_p = 80\mu\text{s}$



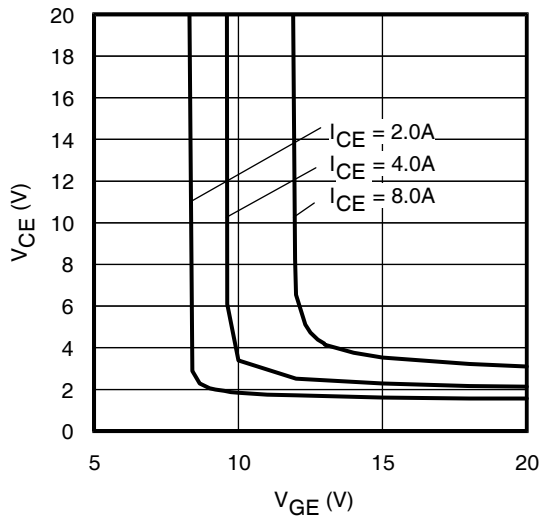
**Fig. 8** - Typ. Diode Forward Characteristics  
 $t_p = 80\mu\text{s}$



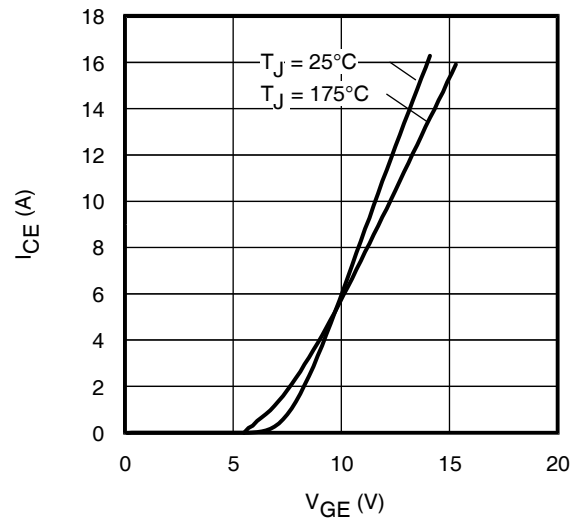
**Fig. 9** - Typical  $V_{CE}$  vs.  $V_{GE}$   
 $T_J = -40^\circ\text{C}$



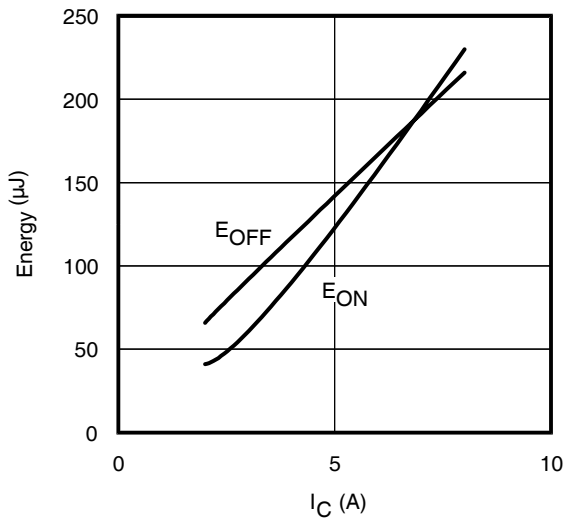
**Fig. 10** - Typical  $V_{CE}$  vs.  $V_{GE}$   
 $T_J = 25^\circ\text{C}$



**Fig. 11** - Typical  $V_{CE}$  vs.  $V_{GE}$   
 $T_J = 175^\circ\text{C}$

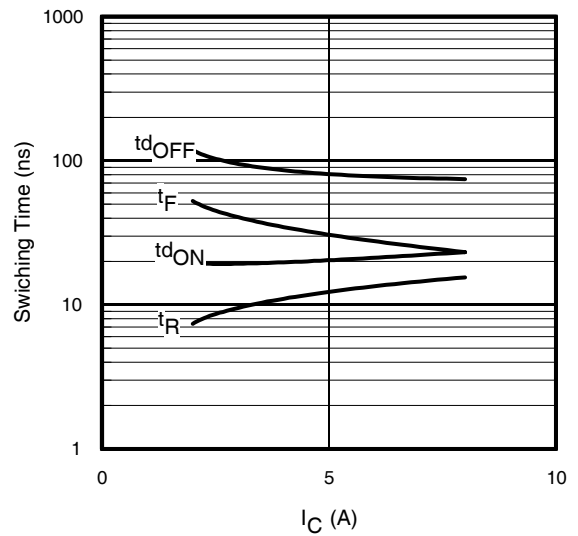


**Fig. 12** - Typ. Transfer Characteristics  
 $V_{CE} = 50\text{V}$ ;  $t_p = 10\mu\text{s}$



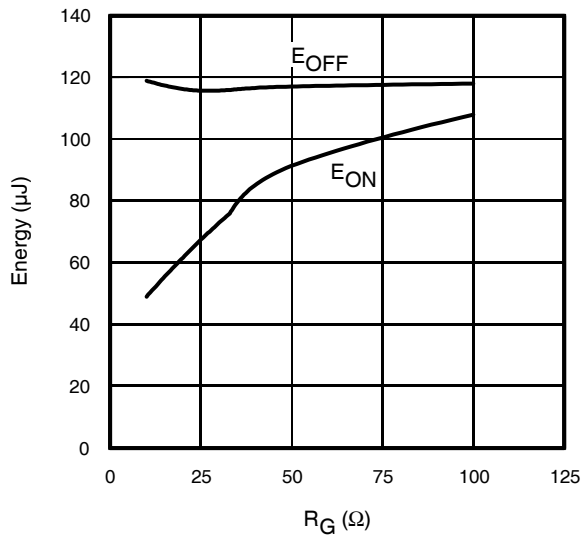
**Fig. 13** - Typ. Energy Loss vs.  $I_C$

$T_J = 175^\circ\text{C}$ ;  $L = 1\text{mH}$ ;  $V_{CE} = 400\text{V}$ ;  $R_G = 100\Omega$ ;  $V_{GE} = 15\text{V}$ .



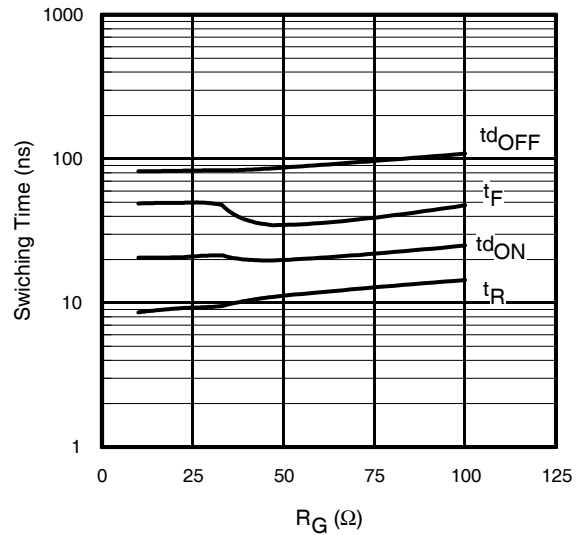
**Fig. 14** - Typ. Switching Time vs.  $I_C$

$T_J = 175^\circ\text{C}$ ;  $L = 1\text{mH}$ ;  $V_{CE} = 400\text{V}$   
 $R_G = 100\Omega$ ;  $V_{GE} = 15\text{V}$



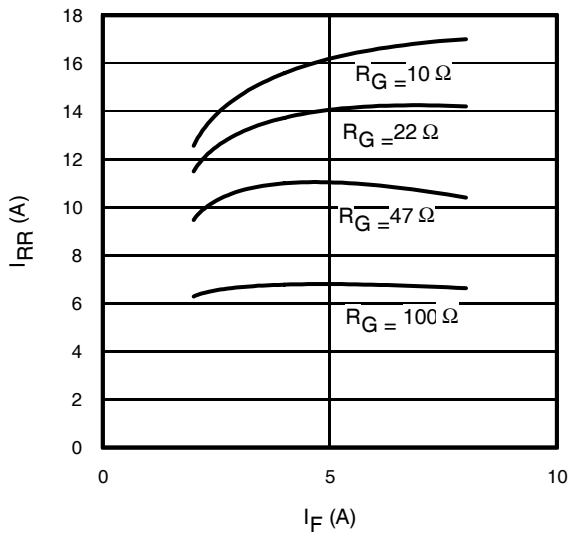
**Fig. 15** - Typ. Energy Loss vs.  $R_G$

$T_J = 175^\circ\text{C}$ ;  $L = 1\text{mH}$ ;  $V_{CE} = 400\text{V}$ ;  $I_{CE} = 4\text{A}$ ;  $V_{GE} = 15\text{V}$



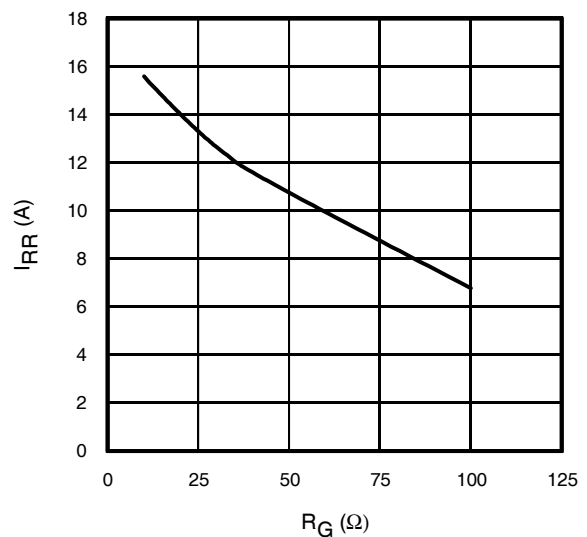
**Fig. 16** - Typ. Switching Time vs.  $R_G$

$T_J = 175^\circ\text{C}$ ;  $L = 1\text{mH}$ ;  $V_{CE} = 400\text{V}$   
 $I_{CE} = 4\text{A}$ ;  $V_{GE} = 15\text{V}$



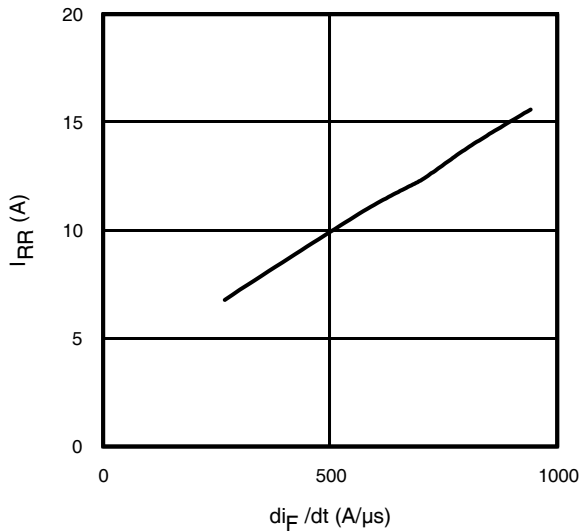
**Fig. 17** - Typical Diode  $I_{RR}$  vs.  $I_F$

$T_J = 175^\circ\text{C}$

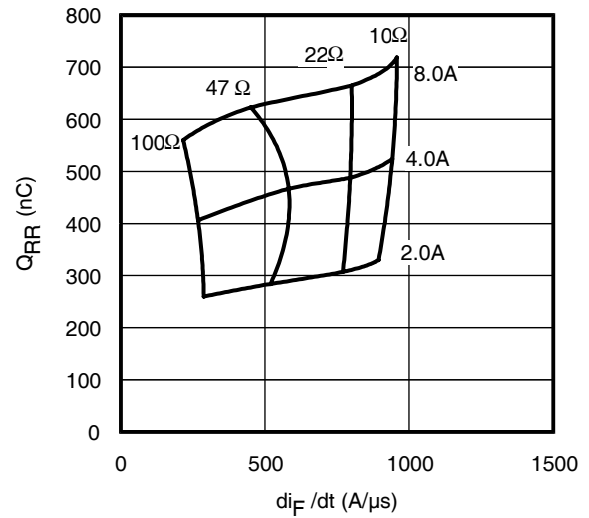


**Fig. 18** - Typical Diode  $I_{RR}$  vs.  $R_G$

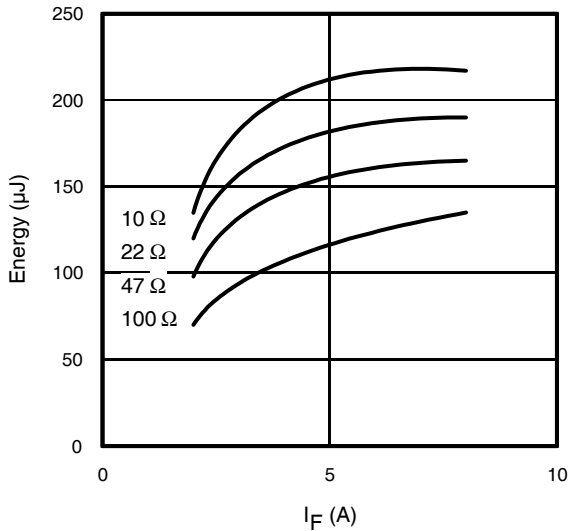
$T_J = 175^\circ\text{C}$ ;  $I_F = 4.0\text{A}$



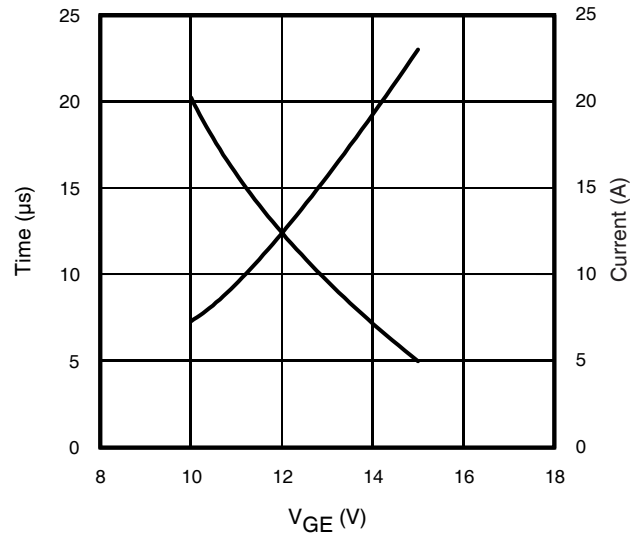
**Fig. 19**- Typical Diode  $I_{RR}$  vs.  $di_F/dt$   
 $V_{CC}=400V$ ;  $V_{GE}=15V$ ;  
 $I_{CE}=4A$ ;  $T_J=175^\circ C$



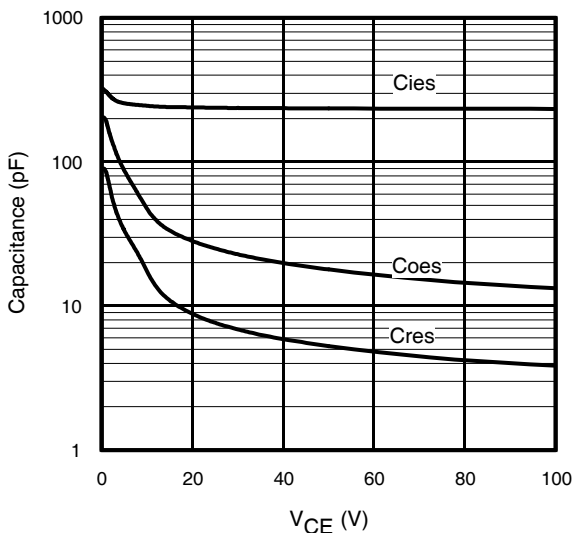
**Fig. 20** - Typical Diode  $Q_{RR}$   
 $V_{CC}=400V$ ;  $V_{GE}=15V$ ;  $T_J=175^\circ C$



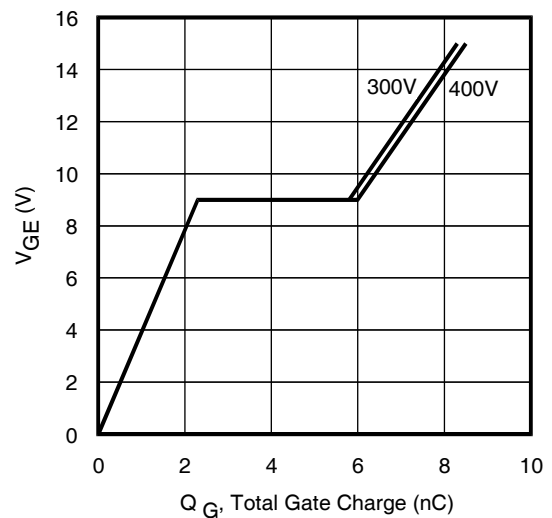
**Fig. 21** - Typical Diode  $E_{RR}$  vs.  $I_F$   
 $T_J=175^\circ C$



**Fig. 22**- Typ.  $V_{GE}$  vs Short Circuit Time  
 $V_{CC}=400V$ ,  $T_C=25^\circ C$



**Fig. 23**- Typ. Capacitance vs.  $V_{CE}$   
 $V_{GE}=0V$ ;  $f=1MHz$



**Fig. 24** - Typical Gate Charge vs.  $V_{GE}$   
 $I_{CE}=4A$ ,  $L=600\mu H$

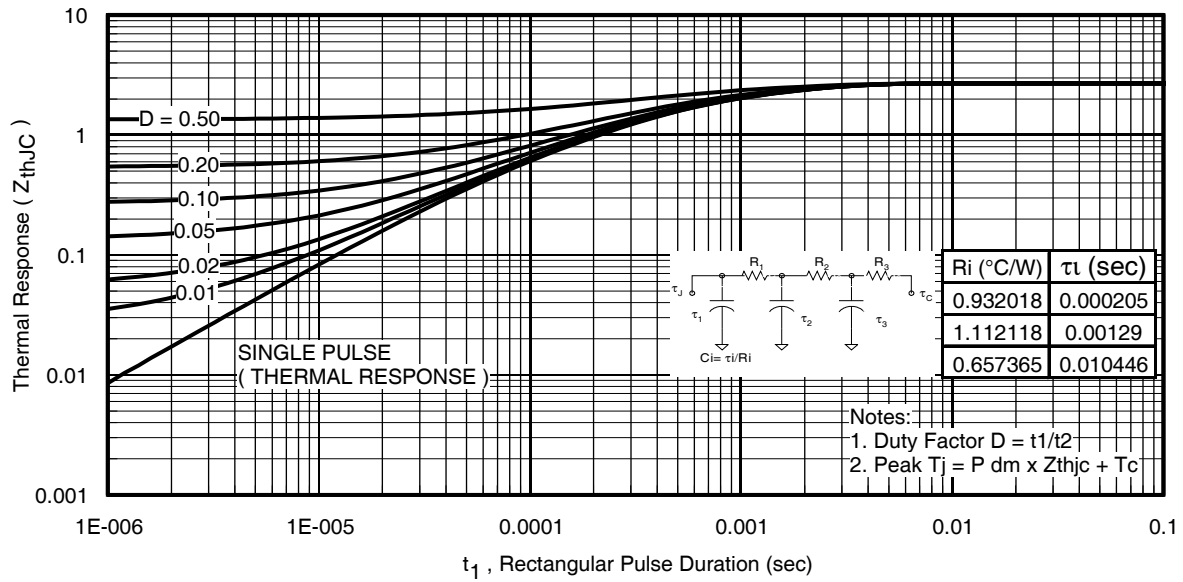


Fig 25. Maximum Transient Thermal Impedance, Junction-to-Case (IGBT)

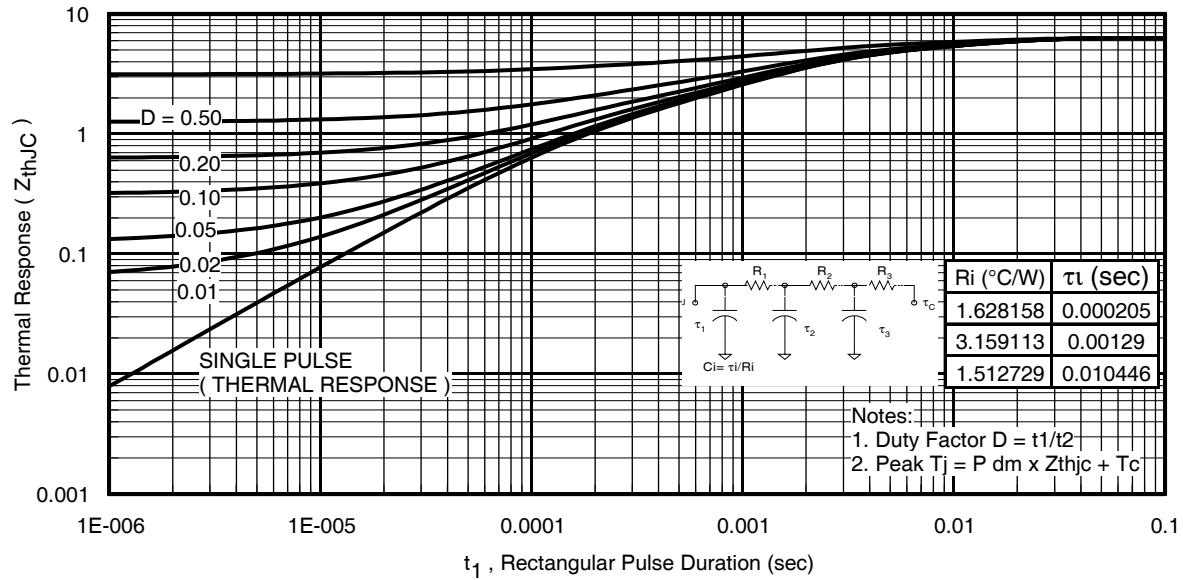
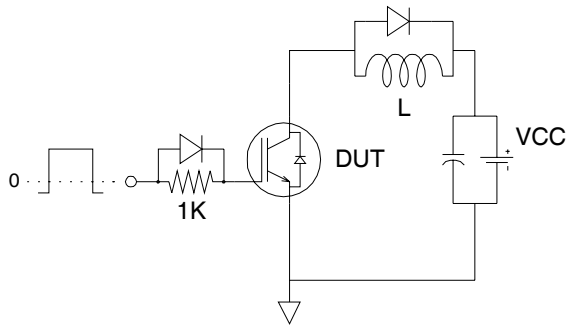
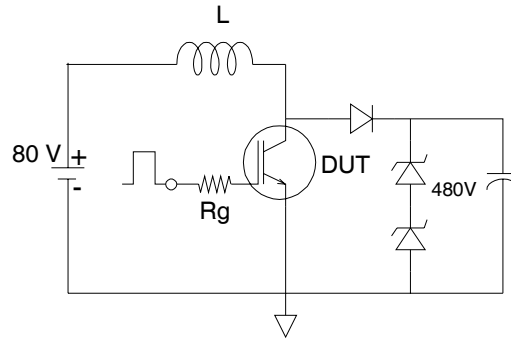


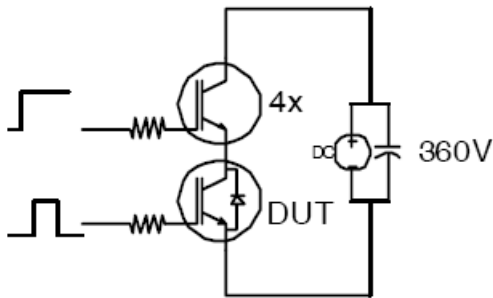
Fig 26. Maximum Transient Thermal Impedance, Junction-to-Case (DIODE)



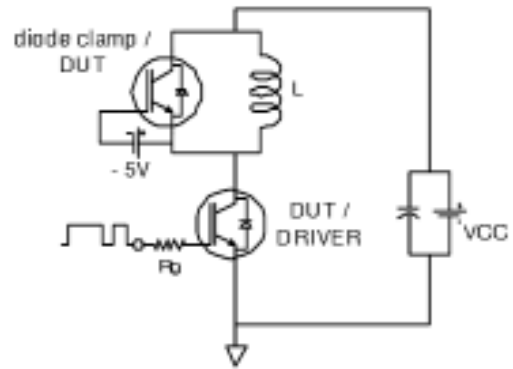
**Fig.C.T.1** - Gate Charge Circuit (turn-off)



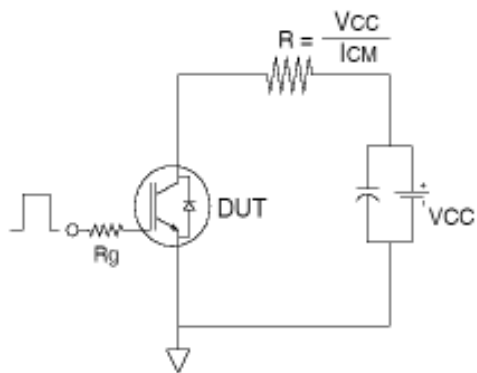
**Fig.C.T.2** - RBSOA Circuit



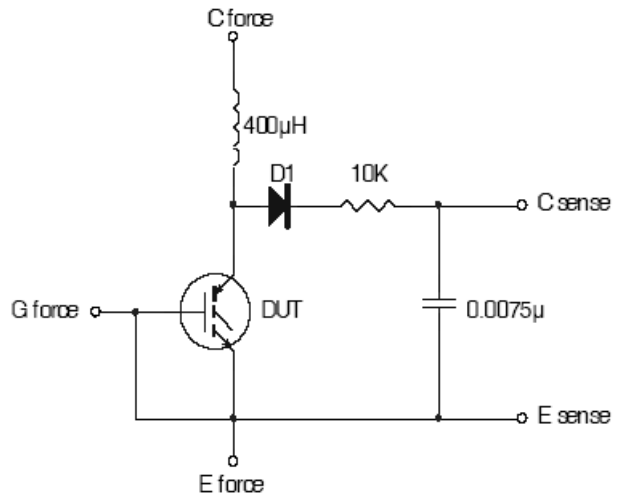
**Fig.C.T.3** - S.C.SOA Circuit



**Fig.C.T.4** - Switching Loss Circuit

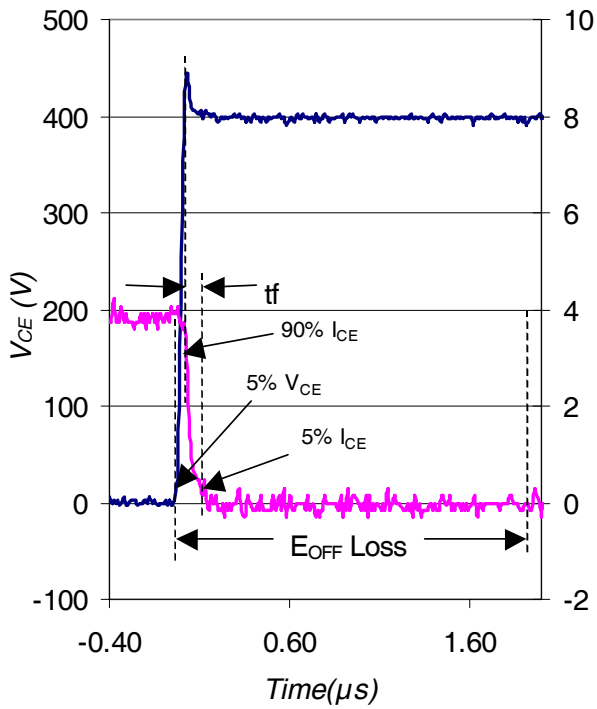


**Fig.C.T.5** - Resistive Load Circuit

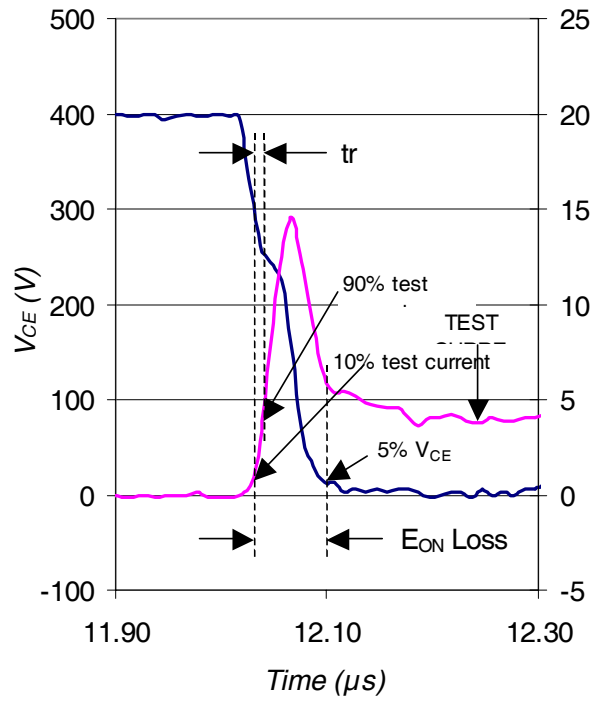


**Fig.C.T.6** - Typical Filter Circuit for  $V_{(BR)CES}$  Measurement

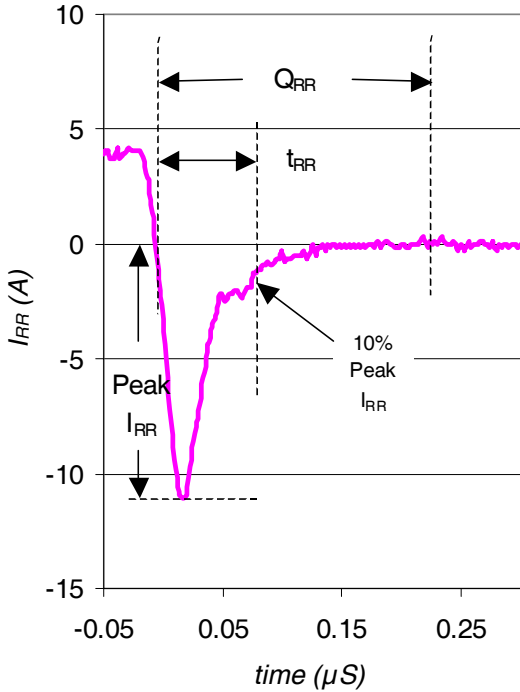




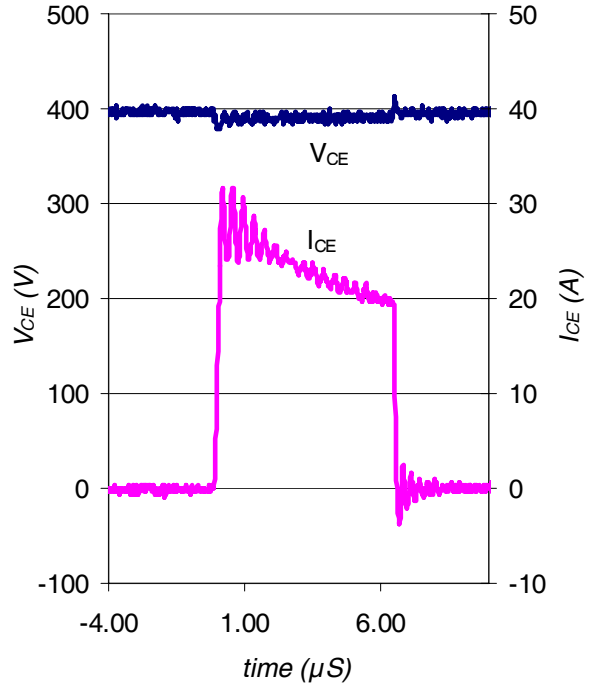
**Fig. WF1** - Typ. Turn-off Loss Waveform  
@  $T_J = 175^\circ\text{C}$  using Fig. CT.4



**Fig. WF2** - Typ. Turn-on Loss Waveform  
@  $T_J = 175^\circ\text{C}$  using Fig. CT.4

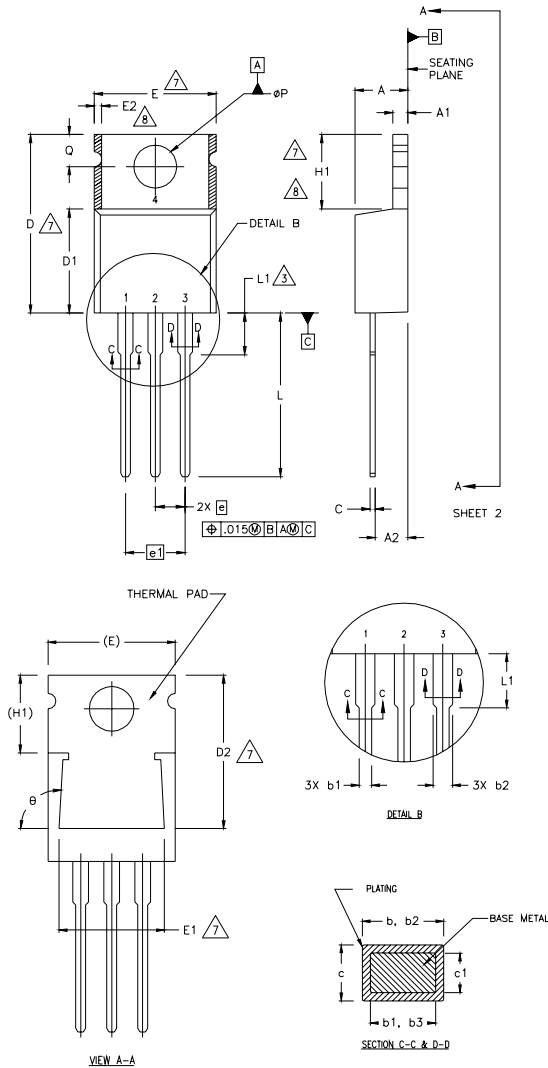


**WF.3**- Typ. Reverse Recovery Waveform  
@  $T_J = 175^\circ\text{C}$  using CT.4



**WF.4**- Typ. Short Circuit Waveform  
@  $T_J = 25^\circ\text{C}$  using CT.3

## TO-220AB Package Outline (Dimensions are shown in millimeters (inches))



**NOTES:**

- 1 DIMENSIONING AND TOLERANCING PER ASME Y14.5 M- 1994.
- 2 DIMENSIONS ARE SHOWN IN INCHES [MILLIMETERS].
- 3 LEAD DIMENSION AND FINISH UNCONTROLLED IN L1.
- 4 DIMENSION D & E DO NOT INCLUDE MOLD FLASH. MOLD FLASH SHALL NOT EXCEED .005" (0.127) PER SIDE. THESE DIMENSIONS ARE MEASURED AT THE OUTERMOST EXTREMES OF THE PLASTIC BODY.
- 5 DIMENSION b1 & c1 APPLY TO BASE METAL ONLY.
- 6 CONTROLLING DIMENSION : INCHES.
- 7 THERMAL PAD CONTOUR OPTIONAL WITHIN DIMENSIONS E,H1,D2 & E1
- 8 DIMENSION E2 X H1 DEFINE A ZONE WHERE STAMPING AND SINGULATION IRREGULARITIES ARE ALLOWED.

**LEAD ASSIGNMENTS**

**HEXFET**

- 1.- GATE
- 2.- DRAIN
- 3.- SOURCE

**IGBTs, CoPACK**

- 1.- GATE
- 2.- COLLECTOR
- 3.- EMITTER

**DIODES**

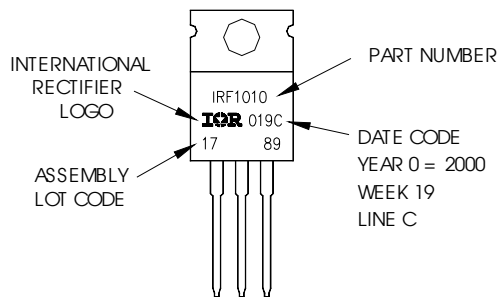
- 1.- ANODE/OPEN
- 2.- CATHODE
- 3.- ANODE

SYMBOL	DIMENSIONS				NOTES
	MILLIMETERS		INCHES		
	MIN.	MAX.	MIN.	MAX.	
A	3.56	4.82	.140	.190	
A1	0.51	1.40	.020	.055	
A2	2.04	2.92	.080	.115	
b	0.38	1.01	.015	.040	
b1	0.38	0.96	.015	.038	5
b2	1.15	1.77	.045	.070	
b3	1.15	1.73	.045	.068	
c	0.36	0.61	.014	.024	
c1	0.36	0.56	.014	.022	5
D	14.22	16.51	.560	.650	4
D1	8.38	9.02	.330	.355	
D2	12.19	12.88	.480	.507	7
E	9.66	10.66	.380	.420	4,7
E1	8.38	8.89	.330	.350	7
e	2.54 BSC		.100 BSC		
e1	5.08		.200 BSC		
H1	5.85	6.55	.230	.270	7,8
L	12.70	14.73	.500	.580	
L1	-	6.35	-	.250	3
øP	3.54	4.08	.139	.161	
Q	2.54	3.42	.100	.135	
ø	90°-93°		90°-93°		

## TO-220AB Part Marking Information

EXAMPLE: THIS IS AN IRF1010  
 LOT CODE 1789  
 ASSEMBLED ON WW 19, 2000  
 IN THE ASSEMBLY LINE "C"

Note: "P" in assembly line position indicates "Lead - Free"



TO-220AB packages are not recommended for Surface Mount Application.

Data and specifications subject to change without notice.  
 This product has been designed and qualified for Industrial market.  
 Qualification Standards can be found on IR's Web site.

Note: For the most current drawings please refer to the IR website at:  
<http://www.irf.com/package/>