



12.5 Gbps LIMITING AMPLIFIER w/ LOSS OF SIGNAL FEATURE

Typical Applications

The HMC914LP4E is ideal for:

- SONET/SDH-Based Transmission Systems
- OC-192 Fiber Optic Modules
- 10 Gigabit Ethernet
- 8x and 10x Fiber Channel
- Wideband RF Gain Block

Features

- Supports Data Rates up to 12.5 Gbps
- Differential Small Signal Gain: 32 dB
- Programmable Loss-of-Signal Detection (LOS)
- Automatic Output Disable Mode
- Adjustable Output Voltage Swing up to 750 mVp-p Differential
- Integrated DC Offset Correction
- Received Signal Strength Indicator (RSSI) Output
- 24 Lead Plastic 4x4mm SMT Package: 16mm²

Functional Diagram

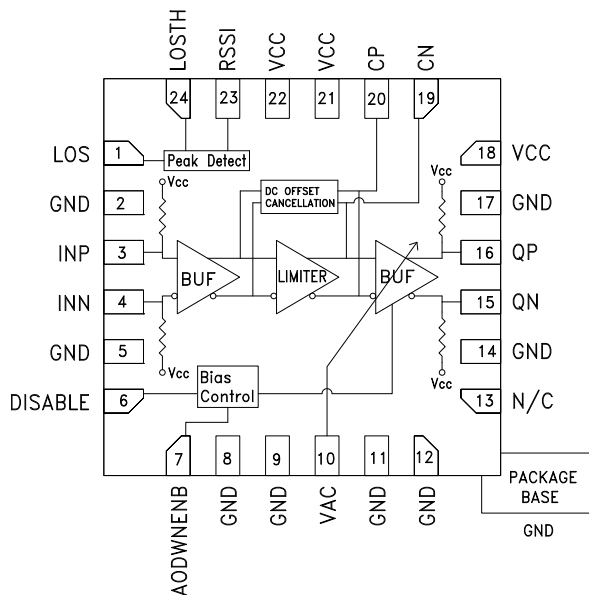

General Description

HMC914LP4E is a limiting amplifier designed to support data transmission rates up to 12.5 Gbps. The amplifier can operate over a wide range of input voltage levels and provides constant-level differential output swing. HMC914LP4E features a loss of signal (LOS) indicator output where the input signal amplitude threshold level can be adjusted using the LOSTH pin. HMC914LP4E also features an output level control pin, VAC, which allows for loss compensation or for output signal level optimization. Differential output signal swing can be adjusted up to 750 mVp-p. An integrated DC offset compensation is also provided on chip. The HMC914LP4E provides an analog RSSI output voltage which is proportional to input signal amplitude.

All single-ended input signals are terminated with 50 ohms to +3.3V on-chip, and may be either AC or DC coupled. The outputs of the HMC914LP4E may be operated either differentially or single-ended. The HMC914LP4E operates from a single +3.3V DC supply and is available in a plastic RoHS compliant 4x4 mm SMT package.

Electrical Specifications, $T_A = +25^\circ C$, $V_{CC} = +3.3V$

Parameter	Conditions	Min.	Typ.	Max.	Units
Power Supply Voltage, V_{CC}		3	3.3	3.6	V
Supply Current, I_{CC}	$V_{AC} = 1V$		47		mA
Output Amplitude Control Voltage, V_{AC}		0.4		2.2	V
Differential Small Signal Gain	$V_{AC} = 1V$		32		dB
Maximum Data Rate		12.5			Gbps
Small Signal Bandwidth, f_{3dB-H}	3-dB cutoff frequency		9.5		GHz
Low Frequency Cut-off, f_{3dB-L}	100 nF off chip cap is used		10		kHz

Information furnished by Analog Devices is believed to be accurate and reliable. However, no responsibility is assumed by Analog Devices for its use, nor for any infringements of patents or other rights of third parties that may result from its use. Specifications subject to change without notice. No license is granted by implication or otherwise under any patent or patent rights of Analog Devices. Trademarks and registered trademarks are the property of their respective owners.

For price, delivery, and to place orders: Analog Devices, Inc., One Technology Way, P.O. Box 9106, Norwood, MA 02062-9106
Phone: 781-329-4700 • Order online at www.analog.com
Application Support: Phone: 1-800-ANALOG-D



12.5 Gbps LIMITING AMPLIFIER w/ LOSS OF SIGNAL FEATURE

Electrical Specifications (Continued)

Parameter	Conditions	Min.	Typ.	Max.	Units
Input return loss, S11	Up to 12 GHz	12			dB
Output return loss, S22	Up to 12 GHz	11			dB
Input Sensitivity [1]	VAC = 1V		15		mVp-p
Maximum Input Swing	VAC = 1V		1200		mVp-p diff
Adjustable Data Output Swing Range	VAC = 0.4V - 2.2V	240		750	mVp-p diff
Output P1dB [2]	@ 5 GHz, VAC = 1V		-9.5		dBm
Rise time, tr [3]	VAC = 1V, %20 to %80		29		ps
Fall time, tf [3]	VAC = 1V, %80 to %20		29		ps
Additive RMS jitter, Jd [4]	VAC = 1V		0.3		ps
Input referred voltage noise	@ 5 GHz		3.8		nV/rtHz
	@ 8 GHz		3.6		nV/rtHz
DISABLE Input HIGH Voltage, VIH		2		Vcc	V
DISABLE Input LOW Voltage, VIL		0		0.8	V
AODWENB Input HIGH Voltage, VIH		2		Vcc	V
AODWENB Input LOW Voltage, VIL		0		0.8	V
LOS assert threshold level [5]	R _{TH} = 80 kOhm between LOSTH and GND, Single-Ended		20		mV
	R _{TH} = 8.5 kOhm between LOSTH and VCC, Single-Ended		380		mV
LOS Assert/Deassert Threshold Level [5]	assert, LOSTH internally set, single-ended		63		mV
	deassert, LOSTH internally set, single-ended		110		mV
LOS Hysteresis [5][6]	R _{TH} between LOSTH and VCC	2		4.8	dB
	R _{TH} between LOSTH and GND	5.8		12.2	dB
	LOSTH internally set		4.84		dB
LOS Output HIGH Voltage	1.82 kOhm to VCC (R _{LOS})		3.3		V
LOS Output LOW Voltage	1.82 kOhm to VCC (R _{LOS})		2.65		V
RSSI Sensitivity			2.7		mV/V

[1] Signal-ended input signal level for limited output

[2] Single-ended output

[3] Data Amplitude: Differential 200 mVp-p, Data Rate: 10 Gbps PRBS 2²³-1 pattern

[4] Data Amplitude: Differential 200 mVp-p, Data Rate: 10 Gbps 10101... pattern

[5] See application notes for detailed information

[6] LOS Hysteresis=20*Log(LOS deassert/LOS assert)



**12.5 Gbps LIMITING AMPLIFIER
w/ LOSS OF SIGNAL FEATURE**

**Differential Gain & Return Loss
vs. Frequency [1] [2]**

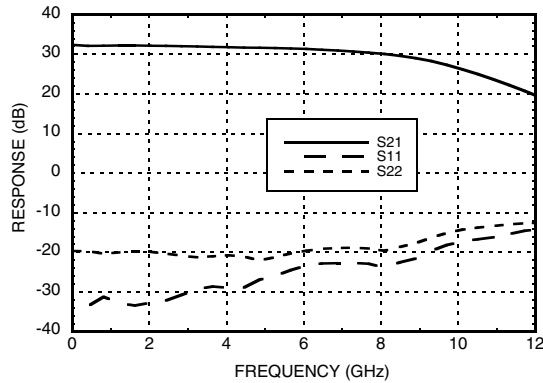

**Differential Gain vs. Frequency
& Temperature [1] [2]**

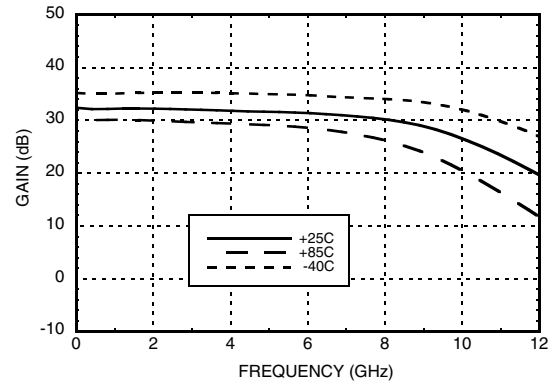

DC Current vs. Supply Voltage [1] [3]

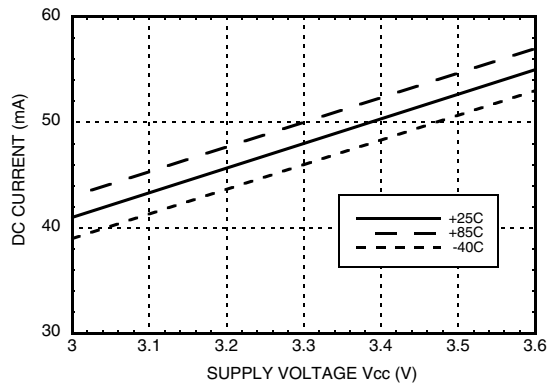

**Differential Output Swing vs.
Supply Voltage [1] [3]**

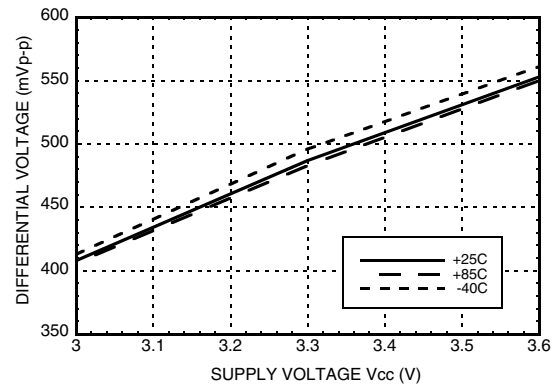

DC Current vs. VAC [2] [3]

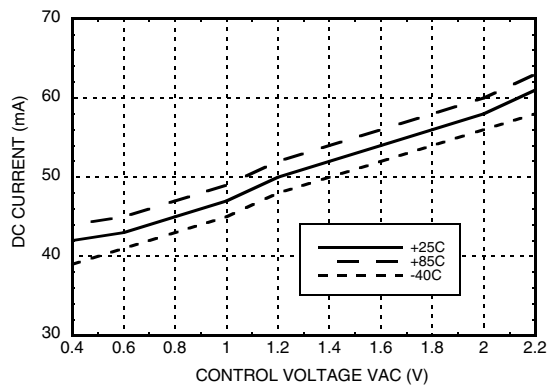

Differential Output Swing vs. VAC [2] [3]

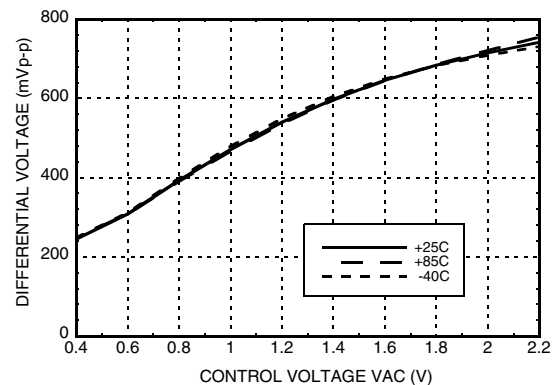

[1] VAC = 1V

[2] VCC=3.3V

[3] Input Data: Differential 200 mVp-p 10 Gbps NRZ PRBS 2²³-1 pattern



12.5 Gbps LIMITING AMPLIFIER w/ LOSS OF SIGNAL FEATURE

Rise Time vs. VAC [1] [2]

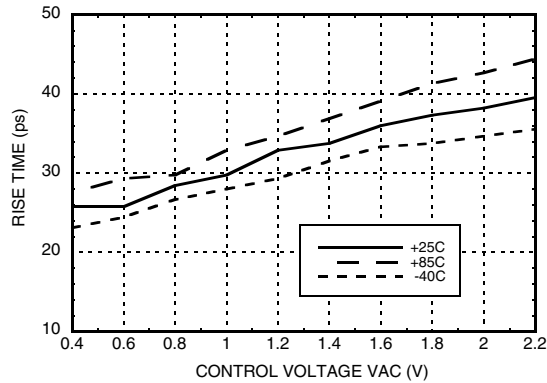

Fall Time vs. VAC [1] [2]

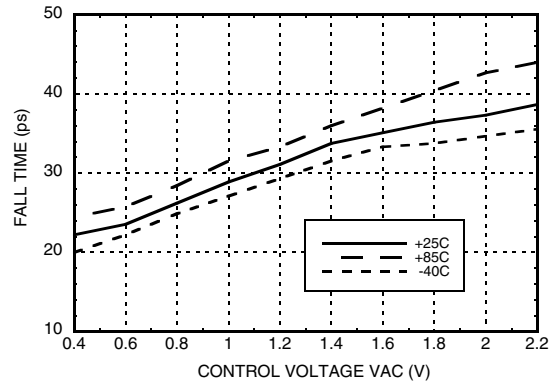

RMS Jitter vs. VAC [1] [3]

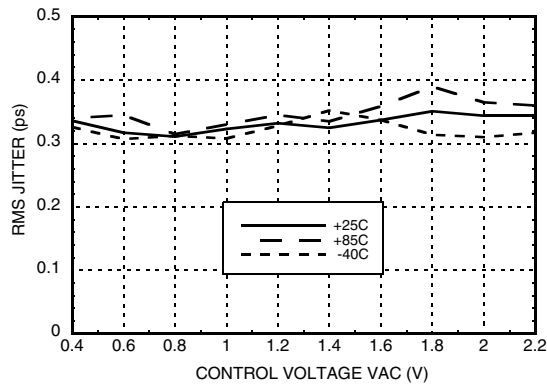

RMS Jitter vs. Single-Ended Input Voltage [1] [4] [5]

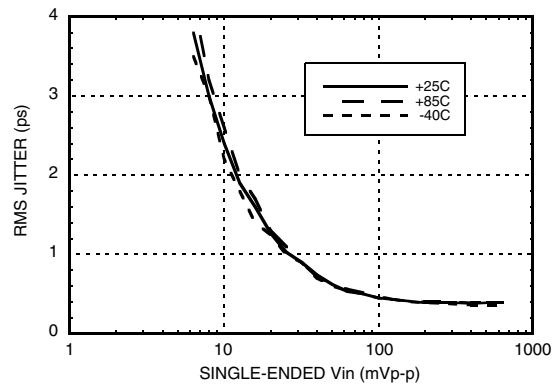

Differential Output Swing vs. Single-Ended Input Voltage [1] [4] [5]

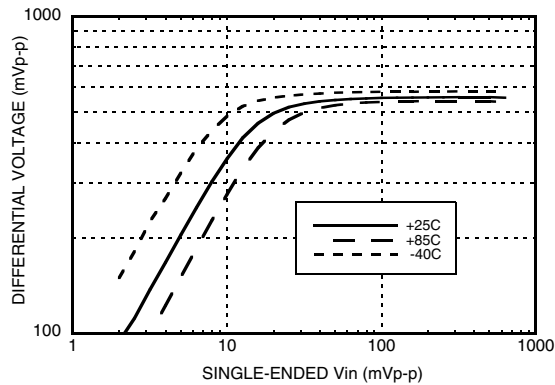

RSSI Voltage vs. Single-Ended Input Voltage [1] [4] [5]

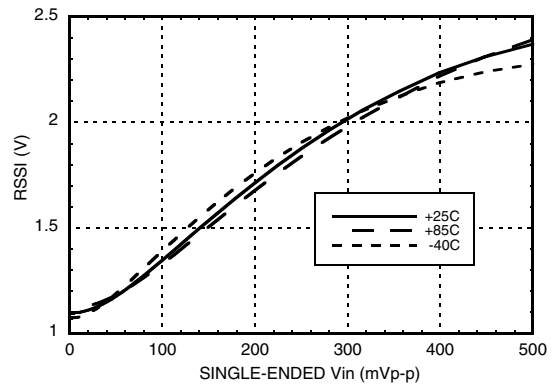

[1] VCC = 3.3V [2] Input Data: Differential 200 mVp-p 10 Gbps NRZ PRBS 2²³-1 pattern
 [3] Input Data: Differential 200 mVp-p 10 Gbps 10101... pattern [4] VAC = 1V [5] Frequency = 5 GHz

Information furnished by Analog Devices is believed to be accurate and reliable. However, no responsibility is assumed by Analog Devices for its use, nor for any infringements of patents or other rights of third parties that may result from its use. Specifications subject to change without notice. No license is granted by implication or otherwise under any patent or patent rights of Analog Devices. Trademarks and registered trademarks are the property of their respective owners.

For price, delivery, and to place orders: Analog Devices, Inc., One Technology Way, P.O. Box 9106, Norwood, MA 02062-9106 Phone: 781-329-4700 • Order online at www.analog.com Application Support: Phone: 1-800-ANALOG-D



12.5 Gbps LIMITING AMPLIFIER w/ LOSS OF SIGNAL FEATURE

Absolute Maximum Ratings

Power Supply Voltage (VCC)	3.8V to -0.5V
Input Voltage (INP-INN)	1V to 3.3V
Output Amplitude Control Voltage (VAC)	0 to 2.4V
Power down input voltage (DISABLE)	0 to 3.6V
Auto power down enable voltage (AOPDWNENB)	0 to 3.6V
Loss of Signal threshold programming current (LOSTH)	±3 mA
Channel Temperature	125 °C
Continuous Pdiss (T = 85 °C) (derate 13.6 mW/°C above 85 °C)	0.54 W
Thermal Resistance (channel to package bottom)	73.5 °C/W
Storage Temperature	-55 to 125 °C
Operating Temperature	-40 to +85 °C

11.25 Gbps Differential Output Eye Diagram for 200 mVp-p Input

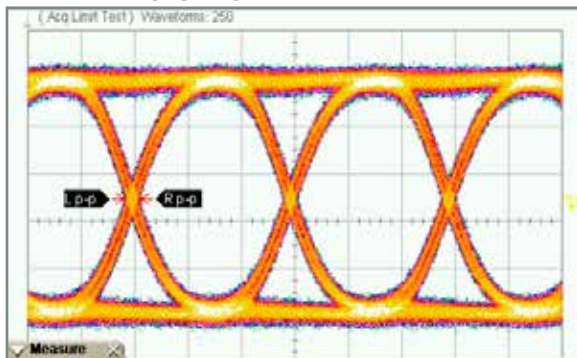

	Current	Minimum	Maximum	Total Meas
Eye Amp	481 mV	481 mV	482 mV	83
Rise Time	30.00 ps	30.00 ps	31.33 ps	83
Fall Time	28.67 ps	28.67 ps	29.33 ps	83
p-p Jitter	9.333 ps	6.667 ps	9.333 ps	83

Time Scale: 30 ps/div
Amplitude Scale: 100 mV/div

Test Conditions:
VCC = 3.3V, VAC = 1V
Data Input:

Differential 200 mVp-p 11.25 Gbps NRZ PRBS 2²³-1 pattern

10 Gbps Differential Output Eye Diagram for 10 mVp-p Input

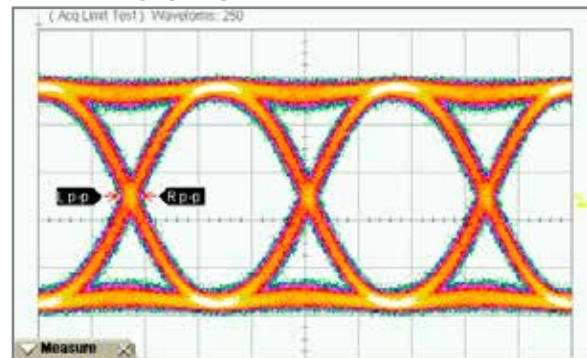

	Current	Minimum	Maximum	Total Meas
Eye Amp	358 mV	358 mV	358 mV	81
Rise Time	36.00 ps	36.00 ps	37.33 ps	81
Fall Time	35.33 ps	34.67 ps	36.00 ps	81
p-p Jitter	15.333 ps	12.000 ps	15.333 ps	81

Time Scale: 30 ps/div
Amplitude Scale: 90 mV/div

Test Conditions:
VCC = 3.3V, VAC = 1V

Data Input: Differential 10 mVp-p 10 Gbps NRZ PRBS 2²³-1 pattern



12.5 Gbps LIMITING AMPLIFIER w/ LOSS OF SIGNAL FEATURE

Outline Drawing

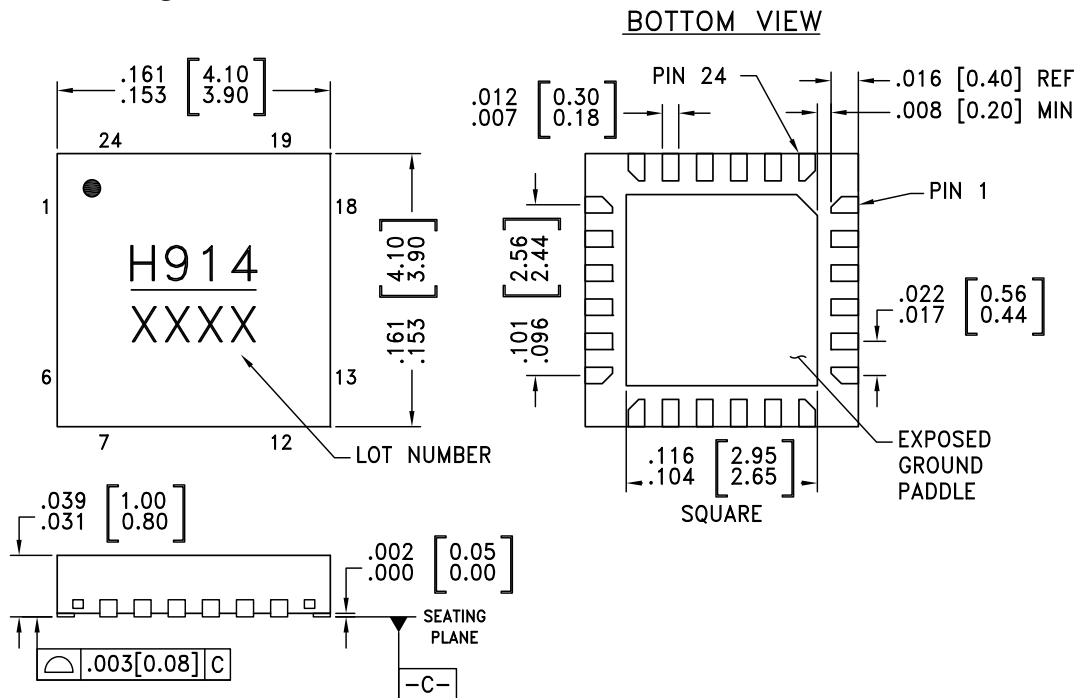

NOTES:

1. LEADFRAME MATERIAL: COPPER ALLOY
2. DIMENSIONS ARE IN INCHES [MILLIMETERS].
3. LEAD SPACING TOLERANCE IS NON-CUMULATIVE
4. PAD BURR LENGTH SHALL BE 0.15mm MAXIMUM.
PAD BURR HEIGHT SHALL BE 0.05mm MAXIMUM.
5. PACKAGE WARP SHALL NOT EXCEED 0.05mm.
6. ALL GROUND LEADS AND GROUND PADDLE MUST BE SOLDERED TO PCB RF GROUND.
7. REFER TO HMC APPLICATION NOTE FOR SUGGESTED PCB LAND PATTERN.

Package Information

Part Number	Package Body Material	Lead Finish	MSL Rating	Package Marking ^[1]
HMC914LP4E	RoHS-compliant Low Stress Injection Molded Plastic	100% matte Sn	MSL1 ^[2]	H914 XXXX

[1] 4-Digit lot number XXXX

[2] Max peak reflow temperature of 260 °C



12.5 Gbps LIMITING AMPLIFIER w/ LOSS OF SIGNAL FEATURE

Pin Descriptions

Pin Number	Function	Description	Interface Schematic
1	LOS	Loss of signal indicator. Open collector output. Requires an external resistor to VCC. This output sinks 500 uA DC current when input is lower than the threshold.	
2, 5, 8, 9, 11, 12, 14, 17 Package Base	GND	Signal and supply ground.	
3, 4	INP, INN	Differential (INP-INN) or single-ended (INP) data inputs.	
6	DISABLE	Disables output buffer. Internally set to VCC. Data outputs are enabled when DISABLE is high or floating.	
7	AODWENB	Enables the automatic output disable feature. If asserted, outputs automatically disable when the input signal is below programmed loss threshold. Active low. Internally set to VCC. Outputs enable when the input signal returns its desired swing level.	
10	VAC	Output Amplitude Control. Internally set for 500 mV differential p-p.	
13	N/C	The pins are not connected internally; however, all data shown herein was measured with these pins connected to RF/DC ground externally.	



12.5 Gbps LIMITING AMPLIFIER w/ LOSS OF SIGNAL FEATURE

Pin Descriptions (Continued)

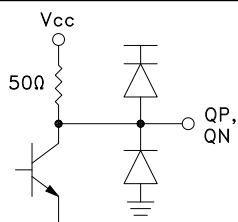
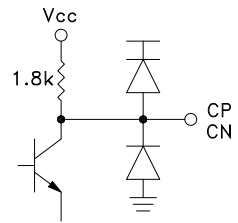
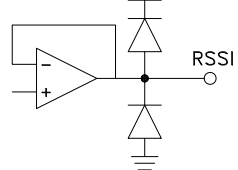
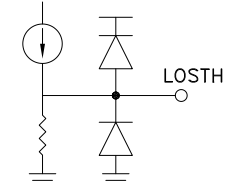
Pin Number	Function	Description	Interface Schematic
15, 16	QN, QP	Differential data outputs	
18, 21, 22	Vcc	Power Supply (+3.3V)	
19, 20	CN, CP	Filter capacitor for offset correction. 100 nF should be connected between these pins.	
23	RSSI	Received Signal Strength Output.	
24	LOSTH	Loss of signal threshold setting input. User programmable with resistor to VCC or GND.	



**12.5 Gbps LIMITING AMPLIFIER
w/ LOSS OF SIGNAL FEATURE**

Evaluation PCB

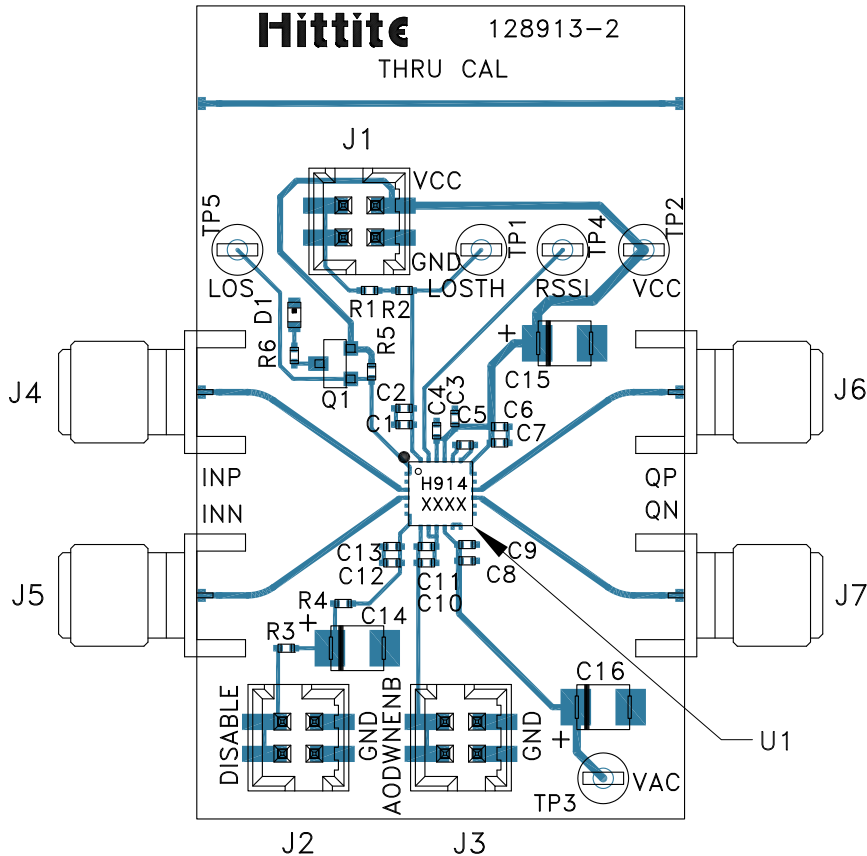

List of Materials for Evaluation PCB 128915 [1]

Item	Description
J1 - J3	4 Pin DC Connector
J4 - J7	SMA Connector
TP1 - TP5	DC Pin
C1 - C2	100 nF Capacitor, 0402 Pkg.
C3, C5, C6, C8, C10, C12	100 nF Capacitor, 0402 Pkg.
C4, C7, C9, C11, C13	1 nF Capacitor, 0402 Pkg.
C14 - C16	4.7 µF Capacitor, Tantalum
R1 - R2	4.75 kOhm Resistor, 0402 Pkg.
R3 - R4	0 Ohm Resistor, 0402 Pkg.
R5	1.82K Ohm Resistor, 0402 Pkg.
R6	390 Ohm Resistor, 0402 Pkg.
D1	LED
Q1	PNP Transistor

Item	Description
U1	HMC914LP4E Limiting Amplifier
PCB [2]	128913 Evaluation PCB

[1] Reference this number when ordering complete evaluation PCB
 [2] Circuit Board Material: Arlon 25FR or Rogers 4350

The circuit board used in the application should use RF circuit design techniques. Signal lines should have 50 Ohm impedance while the package ground leads and exposed paddle should be connected directly to the ground plane similar to that shown. A sufficient number of via holes should be used to connect the top and bottom ground planes. The evaluation circuit board shown is available from Hittite upon request.

Information furnished by Analog Devices is believed to be accurate and reliable. However, no responsibility is assumed by Analog Devices for its use, nor for any infringements of patents or other rights of third parties that may result from its use. Specifications subject to change without notice. No license is granted by implication or otherwise under any patent or patent rights of Analog Devices. Trademarks and registered trademarks are the property of their respective owners.

For price, delivery, and to place orders: Analog Devices, Inc., One Technology Way, P.O. Box 9106, Norwood, MA 02062-9106 Phone: 781-329-4700 • Order online at www.analog.com Application Support: Phone: 1-800-ANALOG-D



**12.5 Gbps LIMITING AMPLIFIER
w/ LOSS OF SIGNAL FEATURE**

Application Information

Loss of Signal and Setting the Input Signal Threshold

The HMC914LP4E features an input signal level monitoring over a broad range. An external resistor is used at LOSTH pin to program the input signal amplitude threshold for generating the LOS output indicator. When this pin is kept floating LOSTH level is set internally to single-ended 63 mVp-p.

LOS is an open collector output suitable for wired-OR connection for parallel alarm signals; it requires an external pull-up resistor, RLOS. If the input signal level drops below the asserted threshold level then, LOS output DC voltage goes low. It goes high only when the input level exceeds the upper hysteresis threshold level. When LOSTH pin is floating then the de-assert level will be single-ended 110 mVp-p. If this function is not required, the LOS output can be left floating.

If input threshold value is desired to be higher than 63 mVp-p then an external RTH resistor should be connected between LOSTH pin and VCC. Desired threshold value can be obtained by changing the value of the resistor Rth as shown in the figures below.

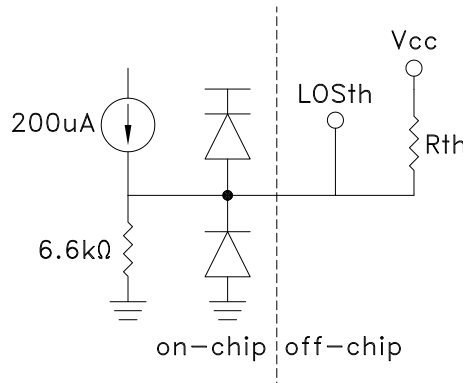

LOS Assert/Deassert Voltage vs. Rth

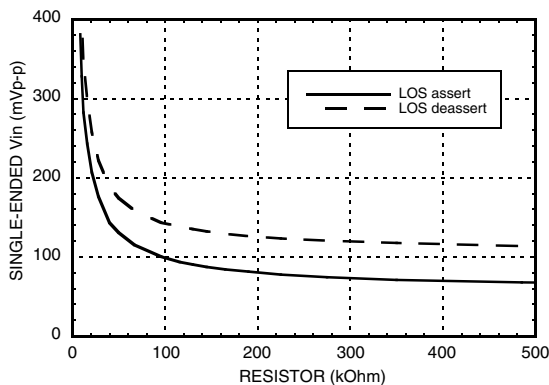

LOS Hysteresis vs. Rth

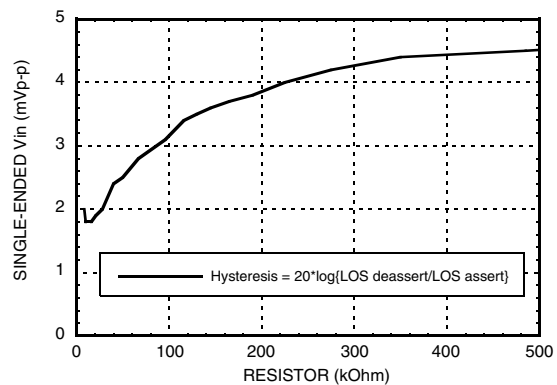

Information furnished by Analog Devices is believed to be accurate and reliable. However, no responsibility is assumed by Analog Devices for its use, nor for any infringements of patents or other rights of third parties that may result from its use. Specifications subject to change without notice. No license is granted by implication or otherwise under any patent or patent rights of Analog Devices. Trademarks and registered trademarks are the property of their respective owners.

For price, delivery, and to place orders: Analog Devices, Inc., One Technology Way, P.O. Box 9106, Norwood, MA 02062-9106 Phone: 781-329-4700 • Order online at www.analog.com Application Support: Phone: 1-800-ANALOG-D



**12.5 Gbps LIMITING AMPLIFIER
w/ LOSS OF SIGNAL FEATURE**

If input threshold value is desired to be lower than 63 mV down to 20 mVp-p then an external RTH resistor should be connected between LOSTH pin and GND. Desired threshold value can be obtained by changing the value of the resistor value as shown in the figures below.

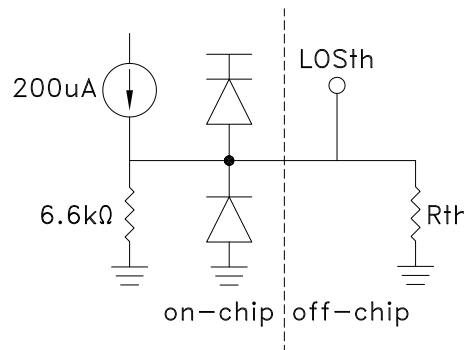

LOS Assert/Deassert Voltage vs. Rth

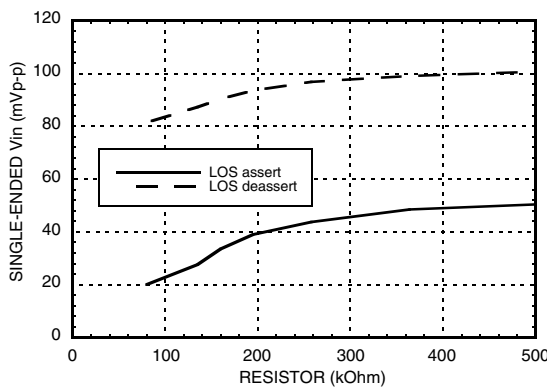

LOS Hysteresis vs. Rth

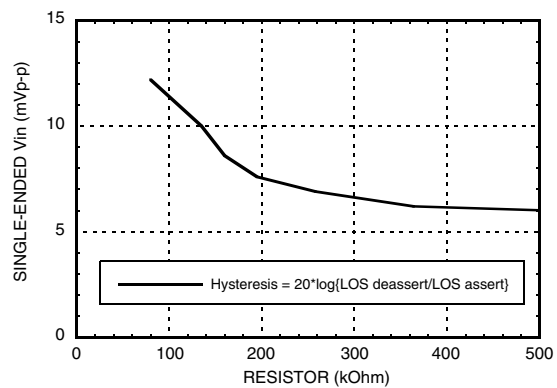

Automatic Output Disable

The HMC914LP4E has two different disable features; one is manual and other is automatic.

DISABLE pin provides manual control over the output. DISABLE pin is a CMOS input and active “low”. There is an integrated pull-up resistor to VCC at this input. If a low level voltage is applied to this input, differential data outputs QP / QN are forced to VCC and Disabled . If this input is left floating or logic high is applied then data outputs are enabled. Disable supply current when DISABLE=0 is 32mA.

Automatic disable mode is activated by AODWNENB CMOS input. This input is active low. To activate the automatic output disable mode logic, a low level voltage should be applied. When this mode is activated, if the input signal is lower than the programmed loss threshold, differential outputs automatically get set to VCC and are disabled. Outputs start toggling for normal operation when the input signal returns to its desired swing level. Disable supply current when AODWNENB =0 is 40mA.