

14 Gpbs, 2:1 DIFFERENTIAL SELECTOR WITH PROGRAMMABLE OUTPUT VOLTAGE

Typical Applications

The HMC858LC4B is ideal for:

- 2:1 Multiplexer up to 14 Gbps
- 16G Fiber Channel
- Serial Data Transmission up to 14 Gbps
- Redundant Path Switching
- Built-in Test
- Broadband Test & Measurement

Features

- Supports High Data Rates: up to 14 Gbps
- Differential or Single-Ended Operation
- Fast Rise and Fall Times: 19 / 20 ps
- Low Power Consumption: 221 mW typ.
- Programmable Differential Output Voltage Swing: 500 - 1300 mVp-p
- Propagation Delay: 87 ps
- Single Supply: -3.3 V
- 24 Lead Ceramic 4x4 mm SMT Package: 16 mm²

Functional Diagram

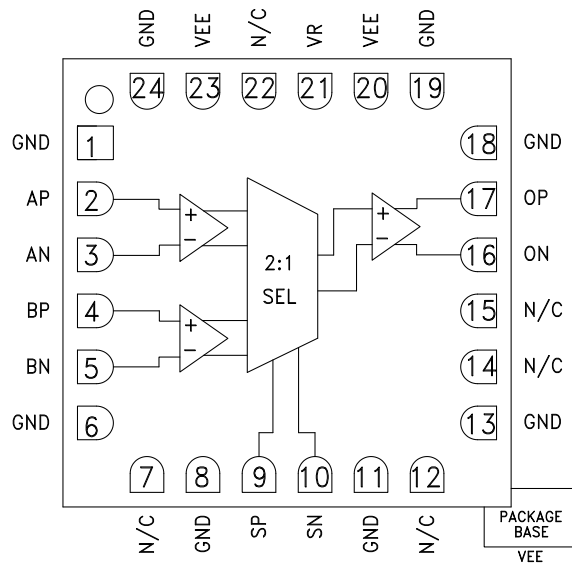

General Description

The HMC858LC4B is a 2:1 Selector designed to support data transmission rates of up to 14 Gbps, and selector port operation of up to 14 GHz. The selector routes one of the two differential inputs to the differential output upon assertion of the proper select port. The HMC858LC4B also features an output level control pin, VR, which allows for loss compensation or for signal level optimization.

All differential input signals to the HMC858LC4B are terminated with 50 ohms to ground on-chip, and may be either AC or DC coupled. The outputs of the HMC858LC4B may be operated either differentially or single-ended. Outputs can be connected directly to a 50 ohm terminated system, while DC blocking capacitors may be used if the terminating system is 50 ohms to a non-ground DC voltage. The HMC858LC4B operates from a single -3.3V DC supply and is available in a ceramic RoHS-compliant, 4x4 mm SMT package.

Electrical Specifications, $T_A = +25^\circ\text{C}$, $V_{ee} = -3.3\text{ V}$

Parameter	Conditions	Min.	Typ.	Max	Units
Power Supply Voltage		-3.6	-3.3	-3.0	V
Power Supply Current			67		mA
Maximum Data Rate			14		Gbps
Maximum Select Rate			14		GHz
Input Voltage Range		-1.5		0.5	V
Input Differential Range		0.1		2.0	Vp-p
Input Return Loss	Frequency <16 GHz		10		dB
Output Amplitude	Single-Ended, peak-to-peak		540		mVp-p
	Differential, peak-to-peak		1080		mVp-p
Output High Voltage			-20		mV
Output Low Voltage			-560		mV

14 Gpbs, 2:1 DIFFERENTIAL SELECTOR WITH PROGRAMMABLE OUTPUT VOLTAGE

Electrical Specifications (continued)

Parameter	Conditions	Min.	Typ.	Max	Units
Output Rise / Fall Time	Differential, 20% - 80%		19 / 20		ps
Output Return Loss	Frequency <16 GHz		10		dB
Random Jitter, Jr	rms [1]		0.08	0.11	ps rms
Deterministic Jitter, Jd	peak-to-peak, 2 ¹⁵ -1 PRBS input [1]		2		ps, p-p
Propagation Delay, A or B to D _{OUT} , td			87		ps
Propagation Delay Select to Data, tds			89		ps

[1] Added jitter calculated by de-embedding the source's jitter at 13 Gpbs, 2¹⁵ -1 PRBS input.

DC Current vs. Supply Voltage [1][2]

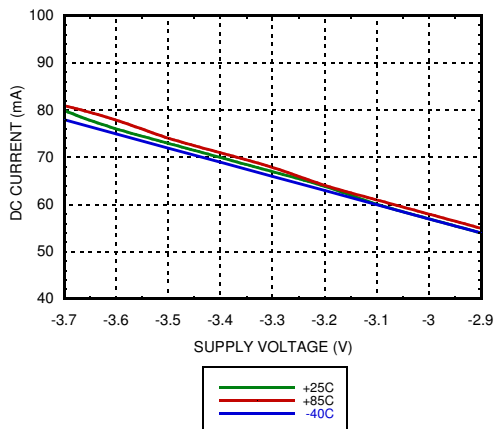

DC Current vs. VR [2][3]

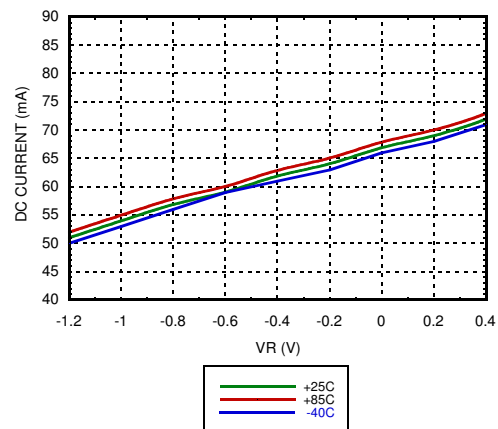

Output Differential Voltage vs. Supply Voltage [1][2]

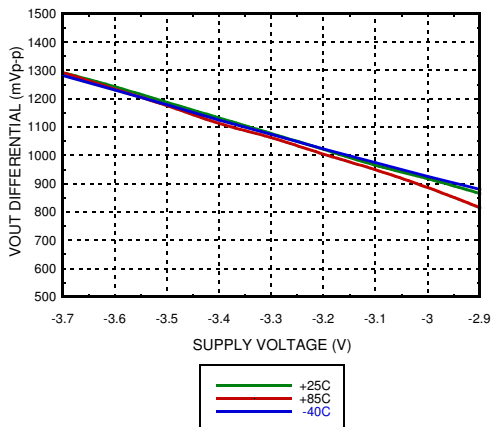

Output Differential Voltage vs. VR [2][3]

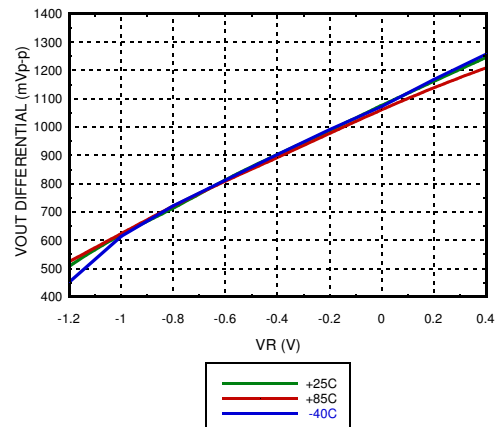

[1] VR = 0.0 V

[2] Frequency = 13 GHz

Vee = -3.3 V



14 Gpbs, 2:1 DIFFERENTIAL SELECTOR WITH PROGRAMMABLE OUTPUT VOLTAGE

HIGH SPEED LOGIC - SMT

Rise / Fall Time vs. Supply Voltage [1][2]

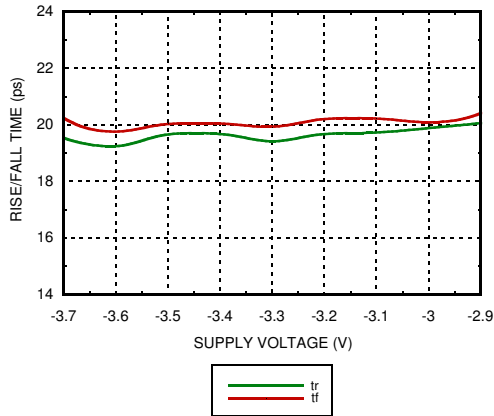

Rise / Fall Time vs. VR [2][3]

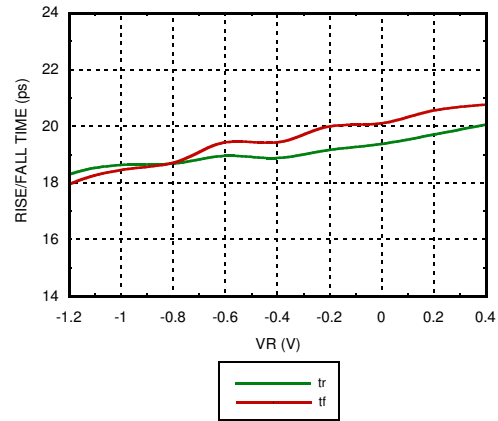

Select Input Return Loss vs. Frequency [1][3][4]

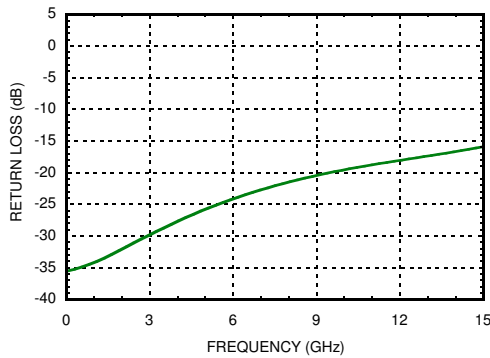

Data Input Return Loss vs. Frequency [1][3][4]

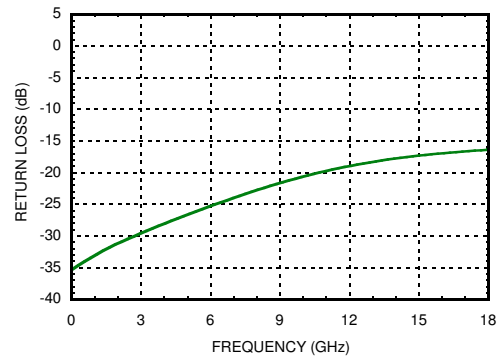

Output Return Loss vs. Frequency [1][3][4]

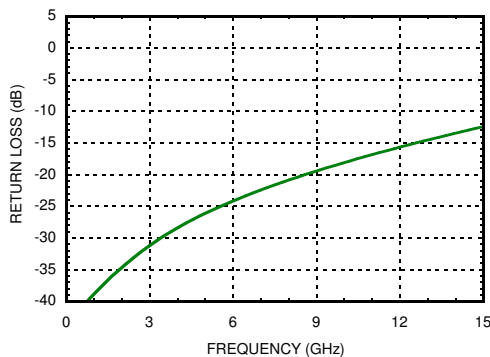

Response vs. Input Power [1][3][5]

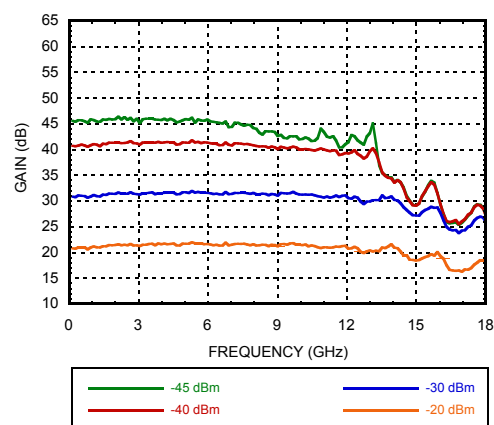

[1] VR = 0.0 V [2] Frequency = 13 GHz [3] Vee = -3.3 V

[4] Device measured on evaluation board with gating after connector

[5] Device measured on evaluation board with port extensions



14 Gpbs, 2:1 DIFFERENTIAL SELECTOR WITH PROGRAMMABLE OUTPUT VOLTAGE

Isolation [1][2][3]

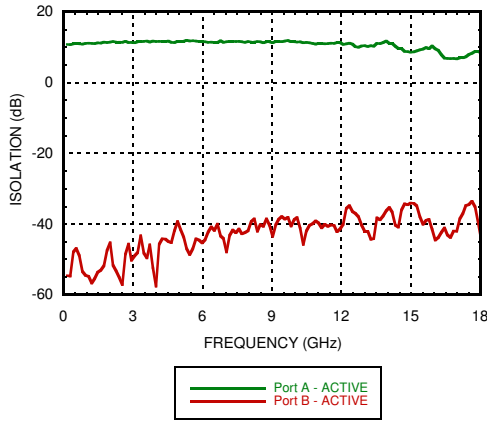

Eye Diagram

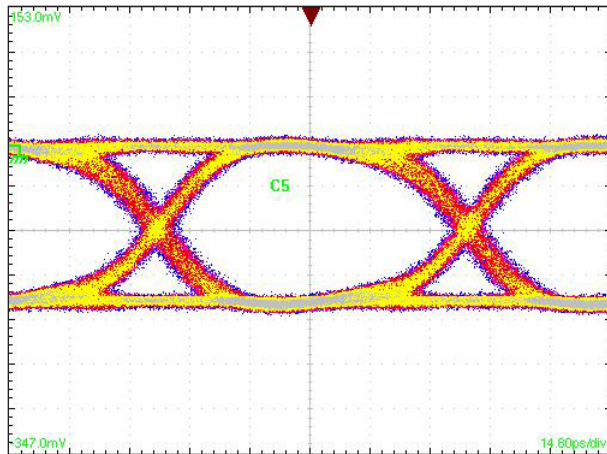

[1] Test Conditions:
 Waveform generated with an Agilent N4903A
 J-Bert differential 400 mV 13 Gbps PN 2¹⁵-1 input signal.
 Eye Diagram data presented on a Tektronix CSA 8000

Timing Diagram

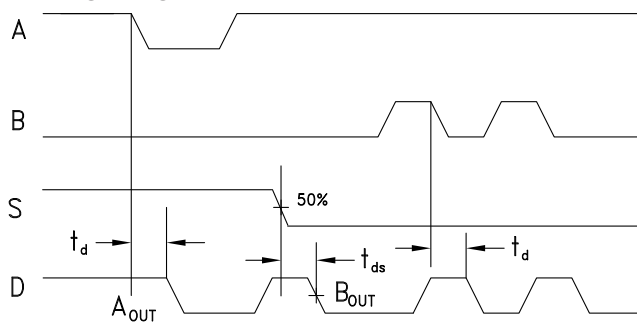

t_d = propagation delay, A to D
 t_{ds} = propagation delay, Select to D

Truth Table

Inputs		Outputs
SP	SN	DP
H	L	A -> D
L	H	B -> D

H = Positive voltage level
 L = Negative voltage level

Notes:
 D = DP - DN
 S = SP - SN

[1] VR = 0.0 V [2] Vee = -3.3 V [3] Device measured on evaluation board with port extensions



14 Gpbs, 2:1 DIFFERENTIAL SELECTOR WITH PROGRAMMABLE OUTPUT VOLTAGE

Absolute Maximum Ratings

Power Supply Voltage (Vee)	-3.75 V to +0.5 V
Input Signals	-2.0 V to 0.5 V
Output Signals	-1.5 V to 0.5 V
Junction Temperature	125 °C
Continuous P _{diss} (T = 85 °C (derate 30.0 mW/°C above 85 °C))	1.22 W
Thermal Resistance (R _{th-j-p}) Worst case device to package paddle	32.8 °C/W
Storage Temperature	-65 °C to +150 °C
Operating Temperature	-40 to +85 °C
ESD Sensitivity (HBM)	Class 1C



ELECTROSTATIC SENSITIVE DEVICE
OBSERVE HANDLING PRECAUTIONS

Outline Drawing

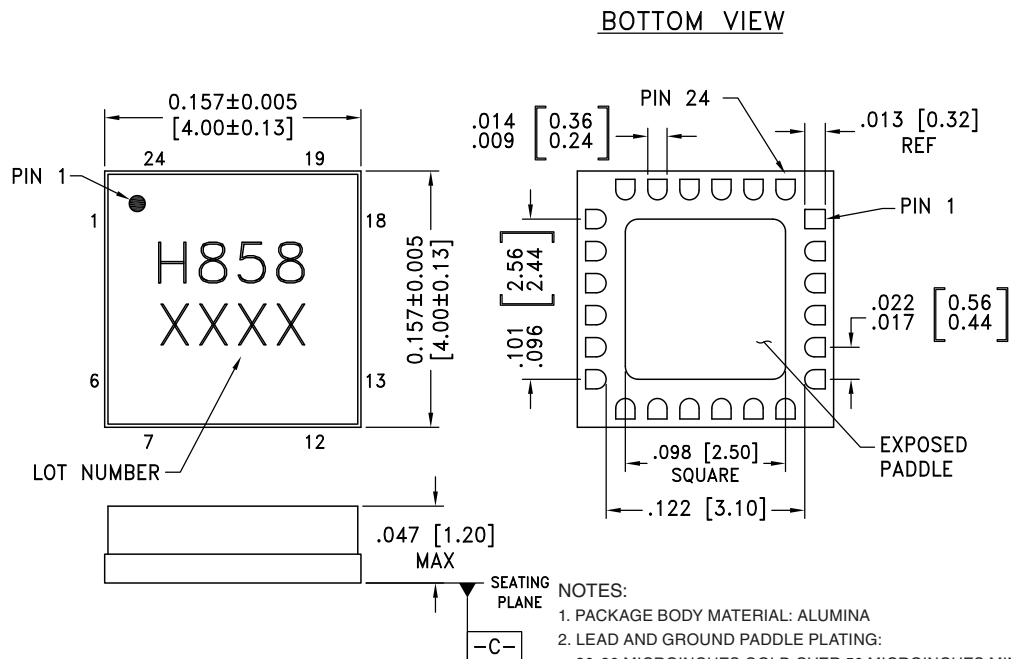

Package Information

Part Number	Package Body Material	Lead Finish	MSL Rating	Package Marking [2]
HMC858LC4B	Alumina, White	Gold over Nickel	MSL3 [1]	H858 XXXX



[1] Max peak reflow temperature of 260 °C

[2] 4-Digit lot number XXXX

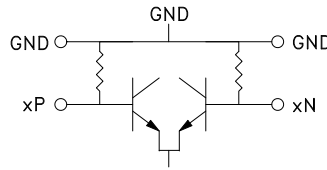
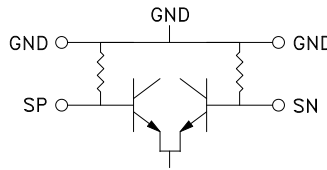
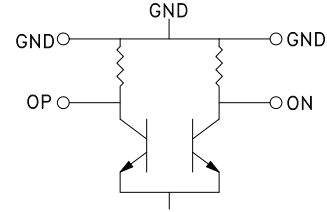

14 Gpbs, 2:1 DIFFERENTIAL SELECTOR WITH PROGRAMMABLE OUTPUT VOLTAGE

Pin Descriptions

Pin Number	Function	Description	Interface Schematic
1, 6, 8, 11, 13, 18	GND	Signal Grounds	
2, 3, 4, 5	AP, AN, BP, BN	Differential Inputs: Current Mode Logic (CML) referenced to positive supply.	
7, 12, 14, 15, 22	N/C	No connection necessary. These pins may be connected to RF/DC ground without affecting performance.	
9, 10	SP, SN	Differential Select Inputs: Current Mode Logic (CML) referenced to positive supply.	
16, 17	ON, OP	Differential Outputs: Current Mode Logic (CML) referenced to positive supply.	
19, 24	GND	Supply Grounds	
20, 23 Package Base	Vee	These pins and the exposed paddle must be connected to the negative voltage supply.	



14 Gpbs, 2:1 DIFFERENTIAL SELECTOR WITH PROGRAMMABLE OUTPUT VOLTAGE

Evaluation PCB

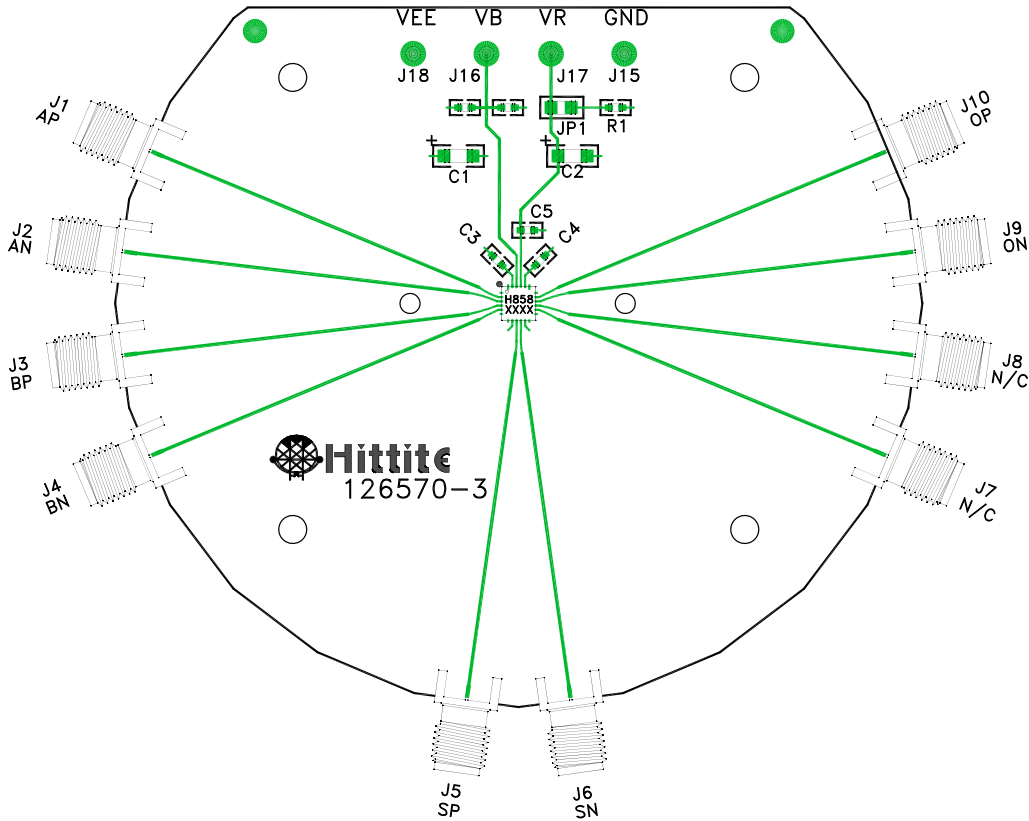

List of Materials for Evaluation PCB 126572 [1]

Item	Description
J1 - J6, J9, J10	PCB Mount SMA RF Connectors
J15 - J18	DC Pin
JP1	0.1" Header with Shorting Jumper
C1, C2	4.7 μ F Capacitor, Tantalum
C3 - C5	100 pF Capacitor, 0603 Pkg.
R1	10 Ohm Resistor, 0603 Pkg.
U1	HMC858LC4B 2:1 Differential Selector
PCB [2]	126570-3 Evaluation Board

[1] Reference this number when ordering complete evaluation PCB

[2] Circuit Board Material: Rogers 4350

The circuit board used in the application should use RF circuit design techniques. Signal lines should have 50 Ohm impedance while the package ground leads should be connected directly to the ground plane similar to that shown. The exposed package base should be connected to Vee. A sufficient number of via holes should be used to connect the top and bottom ground planes. The evaluation circuit board shown is available from Hittite upon request. Install jumper on JP1 to short VR to GND for normal operation.



14 Gpbs, 2:1 DIFFERENTIAL SELECTOR WITH PROGRAMMABLE OUTPUT VOLTAGE

Application Circuit

