

MAXIM

High-Speed, CMOS, Quad, SPST Analog Switch

HI-201HS

General Description

Maxim's HI-201HS is a monolithic, CMOS, quad, single-pole-single-throw (SPST), high-speed analog switch featuring fast switching times (t_{OFF} , $t_{ON} \leq 50\text{ns}$) and low on resistance (50Ω max). It is pin compatible with the industry-standard DG201A.

Maxim's new high-voltage silicon-gate technology increases the maximum supply-voltage rating to 44V. This improvement allows continuous operation with $\pm 20\text{V}$ supplies, which is not permitted with the original manufacturer's devices. Maxim's HI-201HS operates from dual supplies ranging from $\pm 5\text{V}$ to $\pm 20\text{V}$, or from single supplies from +12V to +20V. Logic levels are TTL-/CMOS-compatible with single or dual supplies within these ranges.

Maxim's HI-201HS is guaranteed not to latch up if power supplies are disconnected while the analog-switch inputs are present, provided the switch continuous-current ratings are not exceeded. When powered up, the HI-201HS will switch analog signals up to the power-supply rails.

Applications

- Automatic Test Equipment (ATE)
- Heads-Up Displays
- Communication Systems
- Sample-and-Hold Circuits
- Military
- Integrator Reset Circuits

Features

- ◆ **Guaranteed Single-Supply Operation: +12V to +20V**
- ◆ **Guaranteed Dual Supplies: $\pm 5\text{V}$ to $\pm 20\text{V}$**
- ◆ **Fast Switching Times:**
 $t_{ON} = 30\text{ns}$
 $t_{OFF} = 40\text{ns}$
- ◆ **Low, 50Ω Max On Resistance**
- ◆ **TTL-/CMOS-Compatible**
- ◆ **44V Max Supply Rating**

Ordering Information

PART	TEMP. RANGE	PIN-PACKAGE
HI3-0201HS-5	0°C to +70°C	16 Plastic DIP
HI6-0201HS-5	0°C to +70°C	16 Narrow SO
HI1-0201HS-5	0°C to +70°C	16 CERDIP
HI0-0201HS-6	0°C to +70°C	Dice*
HI3-0201HS-9	-40°C to +85°C	16 Plastic DIP
HI6-0201HS-9	-40°C to +85°C	16 Narrow SO
HI1-0201HS-9	-40°C to +85°C	16 CERDIP
HI1-0201HS-2	-55°C to +125°C	16 CERDIP
HI4-0201HS-8	-55°C to +125°C	20 LCC**

* Contact factory for dice specifications.
 ** Contact factory for availability.

Functional Diagram

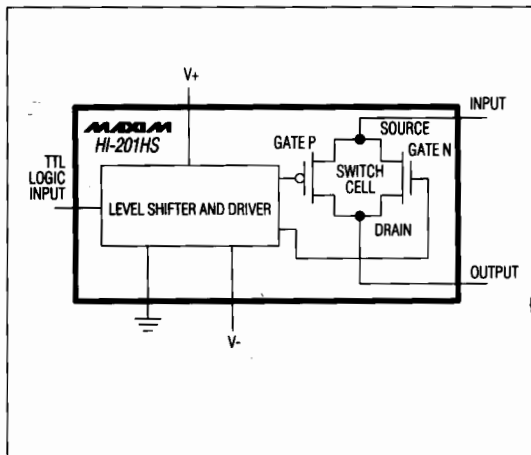

Pin Configurations

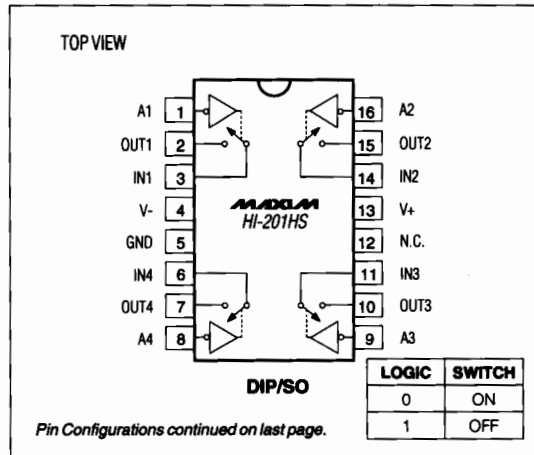

High-Speed, CMOS, Quad, SPST Analog Switch

ABSOLUTE MAXIMUM RATINGS

Voltage Referenced to V-	Continuous Power Dissipation (TA = +70°C, Note 2)
V+ 44V	16-Pin DIP (derate 10.53mW/°C above +70°C) 842mW
GND 25V	16-Pin Wide SO (derate 9.52mW/°C above +70°C) ... 762mW
Digital Inputs VS, VD (Note 1) ... (V- - 4V) to (V+ + 4V) or 30mA (whichever occurs first)	16-Pin CERDIP (derate 10.00mW/°C above +70°C) ... 800mW
Current (any terminal, except S or D) 30mA	20-Pin LCC (derate 9.09mW/°C above +70°C) 727mW
Continuous Current, S or D 20mA	Operating Temperature Ranges:
Peak Current, S or D (pulsed at 1ms, 10% duty cycle max) 40mA	HI-0201HS-5/-6 0°C to +70°C
	HI-0201HS-9 -40°C to +85°C
	HI-0201HS-2/-8 -55°C to +125°C
	Storage Temperature Range -65°C to +150°C
	Lead Temperature (soldering, 10sec) +300°C

Note 1: Signals on Sx, Dx, or INx exceeding V+ or V- are clamped by internal diodes. Limit forward current to maximum current ratings.

Note 2: All leads soldered or welded to PC board.

Stresses beyond those listed under 'Absolute Maximum Ratings' may cause permanent damage to the device. These are stress ratings only, and functional operation of the device at these or any other conditions beyond those indicated in the operational sections of the specifications is not implied. Exposure to absolute maximum rating conditions for extended periods may affect device reliability.

ELECTRICAL CHARACTERISTICS

(V+ = 15V, V- = -15V, GND = 0V, TA = +25°C, unless otherwise noted.)

PARAMETER	SYMBOL	CONDITIONS	HI-201HS-2/-8			HI-201HS-5/-6/-9			UNITS	
			MIN (Note 3)	TYP (Note 4)	MAX	MIN (Note 3)	TYP (Note 4)	MAX		
SWITCH										
Analog-Signal Range	VANALOG		-15		15	-15		15	V	
Drain-Source On Resistance (Note 5)	rDS (on)	VD = ±10V, VIN = 0.8V, IS = 1mA		30	50		30	50	Ω	
Source-Off Leakage Current	IS (off)	VIN = 3.0V	VS = 14V, VD = -14V	-1	±0.01	1	-1	±0.01	1	nA
			VS = -14V, VD = 14V	-1	±0.02	1	-1	±0.02	1	
Drain-Off Leakage Current	ID (off)	VIN = 3.0V	VD = 14V, VS = -14V	-1	±0.01	1	-1	±0.01	1	nA
			VD = -14V, VS = 14V	-1	±0.02	1	-1	±0.02	1	
Drain-On Leakage Current (Note 6)	ID (on)	VD = -14V, VIN = 0.8V	-1	±0.10	1	-1	±0.10	1	nA	
		VD = 14V, VIN = 0.8V	-1	±0.15	1	-1	±0.15	1		
LOGIC INPUT										
Input Current with Input Voltage High	IINH	VIN = 3.0V	-1	0	1	-1	0	1	μA	
		VIN = 15V	-1	0	1	-1	0	1		
Input Current with Input Voltage Low	IINL	VIN = 0.8V	-1	0	1	-1	0	1	μA	

High-Speed, CMOS, Quad, SPST Analog Switch

HI-201HS

ELECTRICAL CHARACTERISTICS (continued)

(V+ = 15V, V- = -15V, GND = 0V, TA = +25°C, unless otherwise noted.)

PARAMETER	SYMBOL	CONDITIONS	HI-201HS-2/-8			HI-201HS-5/-6/-9			UNITS
			MIN (Note 3)	TYP (Note 4)	MAX	MIN (Note 3)	TYP (Note 4)	MAX	
DYNAMIC									
Turn-On Time	t _{on}	Figure 6	30	50		30	50		ns
Turn-Off Time	t _{off}	Figure 6	40	50		40	50		ns
	t _{off2}		150		150				
Output Settling Time			180			180			ns
Charge Injection	Q	C _L = 1000pF, V _{GEN} = 0V, R _{GEN} = 0Ω	10			10			pC
Source-Off Capacitance	C _{S (off)}	V _S = 0V, V _{IN} = 5V	f = 140kHz	10		10			pF
Drain-Off Capacitance	C _{D (off)}	V _S = 0V, V _{IN} = 5V	f = 140kHz	10		10			pF
Channel-On Capacitance	C _{D (on)} ⁺ C _{S (on)}	V _D = V _S = 0V, V _{IN} = 0V	f = 140kHz	30		30			pF
Off Isolation		V _{IN} = 3V _{RMS} , Z _L = 1kΩ, f = 100kHz	72			72			dB
Crosstalk (Channel-to-Channel)		V _S = 2.0V, f = 100kHz	90			90			dB
SUPPLY									
Positive Supply Current	I+	All channels on or off	-3.0	3.8	6.5	-3.0	3.8	6.5	mA
Negative Supply Current	I-		1.0			1.0			mA
Power-Supply Range for Continuous Operation	V _{OP}	(Note 5)	±4.5		±20	±4.5		±20	V

High-Speed, CMOS, Quad, SPST Analog Switch

HI-201HS

ELECTRICAL CHARACTERISTICS

(V+ = 15V, V- = -15V, GND = 0V, TA = TMIN to TMAX, unless otherwise noted.)

PARAMETER	SYMBOL	CONDITIONS	HI-201HS-2/-8			HI-201HS-5/-6/-9			UNITS
			MIN (Note 3)	TYP (Note 4)	MAX	MIN (Note 3)	TYP (Note 4)	MAX	
SWITCH									
Analog-Signal Range	VANALOG		-15		15	-15		15	V
Drain-Source On Resistance (Note 5)	rDS (on)	VD = ±10V, VIN = 0.8V, IS = 1mA			75			75	Ω
Source-Off Leakage Current	IS (off)	VIN = 3.0V	VS = 14V, VD = -14V	-100	100	-50		50	nA
			VS = -14V, VD = 14V	-100	100	-50		50	
Drain-Off Leakage Current	ID (off)	VIN = 3.0V	VD = 14V, VS = -14V	-100	100	-50		50	nA
			VD = -14V, VS = 14V	-100	100	-50		50	
Drain-On Leakage Current (Note 6)	ID (on)	VD = -14V, VIN = 0.8V	-100		100	-50		50	nA
		VD = 14V, VIN = 0.8V	-100		100	-50		50	
LOGIC INPUT									
Input Current with Input Voltage High	IINH	VIN = 3.0V	-1.0		1.0	-1.0		1.0	μA
		VIN = 15V	-1.0		1.0	-1.0		1.0	
Input Current with Input Voltage Low	IINL	VIN = 0.8V	-1.0		1.0	-1.0		1.0	μA
DYNAMIC									
Turn-On Time	ton	See Figure 6			75			75	ns
Turn-Off Time	toff	See Figure 6			75			75	ns
SUPPLY									
Positive Supply Current	I+	All channels on or off			10			10	mA
Negative Supply Current	I-	All channels on or off	6			6			mA

Note 3: The algebraic convention where the most negative value is a minimum and the most positive a maximum is used in this data sheet.

Note 4: Typical values are for DESIGN AID ONLY, not guaranteed or subject to production testing.

Note 5: Electrical characteristics, such as on resistance, will change when power supplies other than ±15V are used.

Note 6: ID(on) is leakage from driver into on switch.

High-Speed, CMOS, Quad, SPST Analog Switch

HI-201HS

Protecting Against Fault Conditions

Fault conditions occur when power supplies are turned off and input signals are still present, or when overvoltages occur at the inputs during normal operation. In either case, source-to-body diodes can be forward biased and conduct current from the signal source. If this current must be kept at low (μA) levels, we recommend adding external protection diodes (Figure 1).

To provide protection for overvoltages up to 20V above the supplies, place a 1N4001 or 1N914 type diode in series with the positive and negative supplies, as shown in Figure 1. Adding these diodes will reduce the analog-signal range to 1V below the positive supply and 1V above the negative supply.

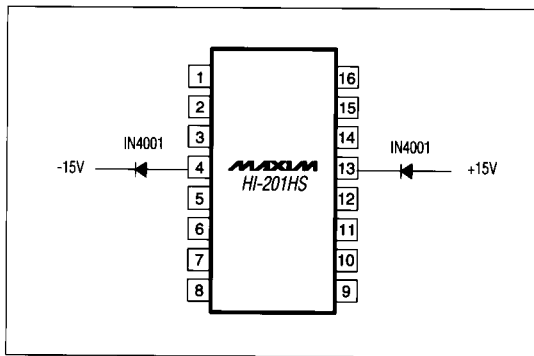

Figure 1. Protection Against Fault Conditions

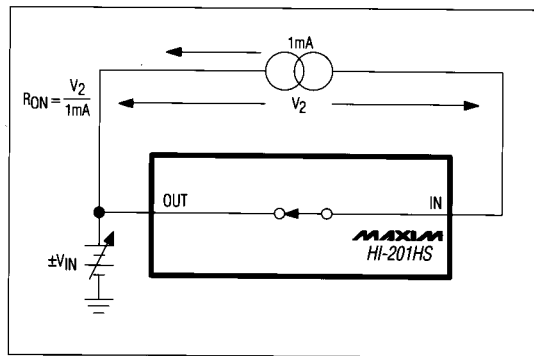

Figure 2. On Resistance

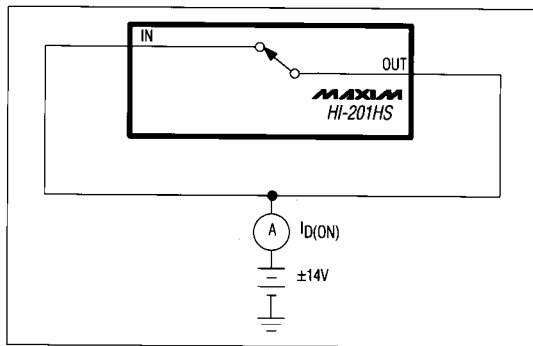

Figure 3. On Leakage Current

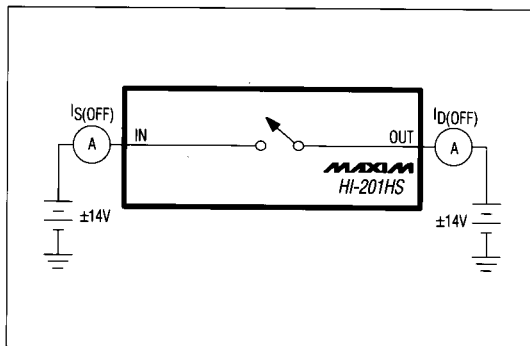

Figure 4. Off Leakage Current

High-Speed, CMOS, Quad, SPST Analog Switch

HI-201HS

Pin Configurations (continued)

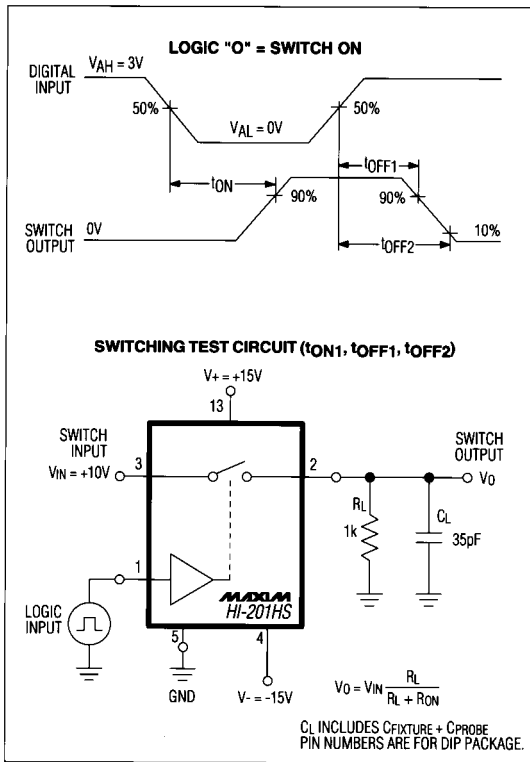
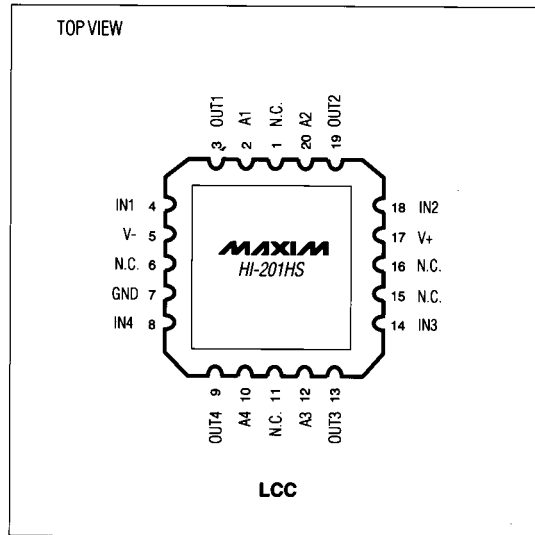

Figure 6. Switching-Time Test Circuit



High-Speed, CMOS, Quad, SPST Analog Switch

Package Information

HI-201HS

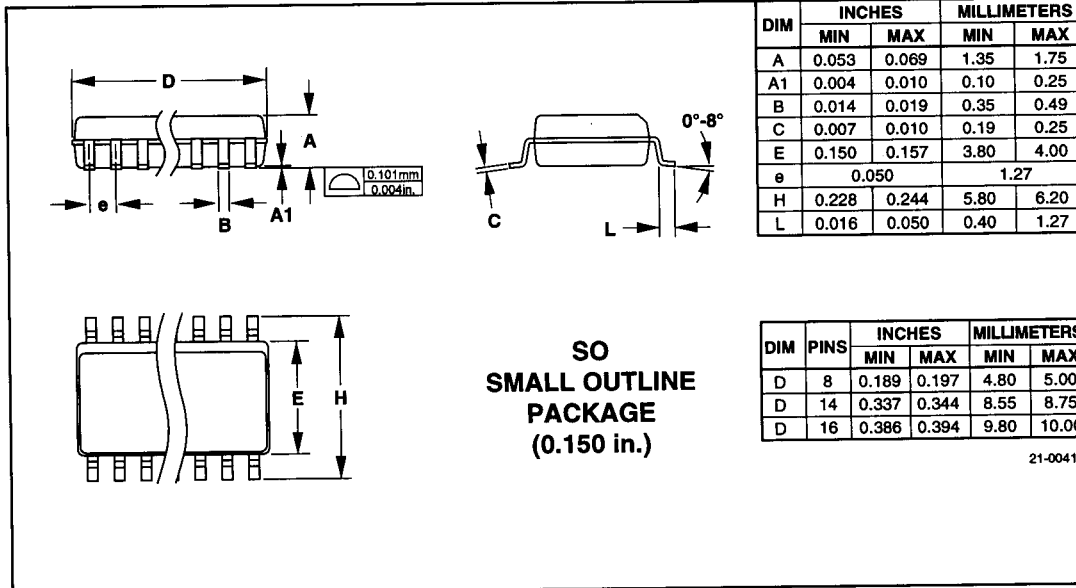
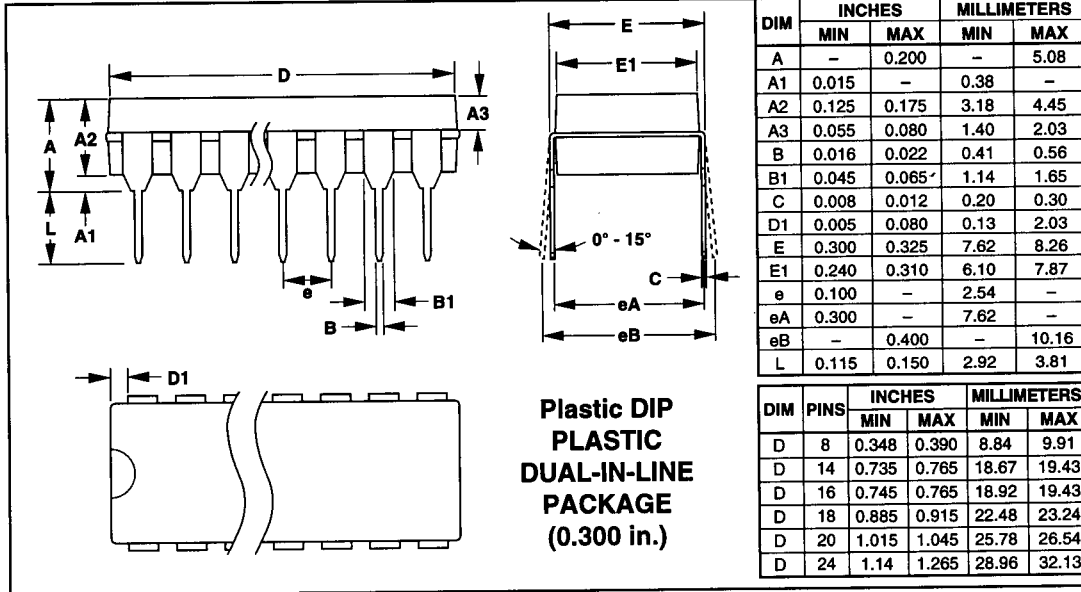

High-Speed, CMOS, Quad, SPST Analog Switch

HI-201HS

Package Information (continued)

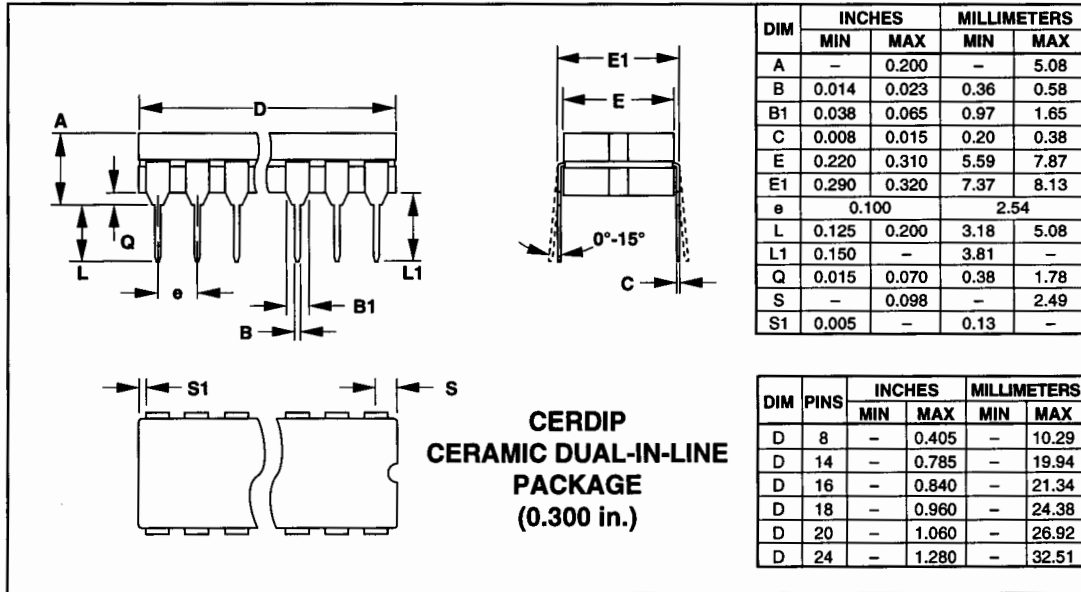

Maxim cannot assume responsibility for use of any circuitry other than circuitry entirely embodied in a Maxim product. No circuit patent licenses are implied. Maxim reserves the right to change the circuitry and specifications without notice at any time.

8 Maxim Integrated Products, 120 San Gabriel Drive, Sunnyvale, CA 94086 (408) 737-7600

© 1994 Maxim Integrated Products

Printed USA

MAXIM is a registered trademark of Maxim Integrated Products.